

To our customers,

---

## Old Company Name in Catalogs and Other Documents

---

On April 1<sup>st</sup>, 2010, NEC Electronics Corporation merged with Renesas Technology Corporation, and Renesas Electronics Corporation took over all the business of both companies. Therefore, although the old company name remains in this document, it is a valid Renesas Electronics document. We appreciate your understanding.

Renesas Electronics website: <http://www.renesas.com>

April 1<sup>st</sup>, 2010  
Renesas Electronics Corporation

Issued by: Renesas Electronics Corporation (<http://www.renesas.com>)

Send any inquiries to <http://www.renesas.com/inquiry>.

## Notice

1. All information included in this document is current as of the date this document is issued. Such information, however, is subject to change without any prior notice. Before purchasing or using any Renesas Electronics products listed herein, please confirm the latest product information with a Renesas Electronics sales office. Also, please pay regular and careful attention to additional and different information to be disclosed by Renesas Electronics such as that disclosed through our website.
2. Renesas Electronics does not assume any liability for infringement of patents, copyrights, or other intellectual property rights of third parties by or arising from the use of Renesas Electronics products or technical information described in this document. No license, express, implied or otherwise, is granted hereby under any patents, copyrights or other intellectual property rights of Renesas Electronics or others.
3. You should not alter, modify, copy, or otherwise misappropriate any Renesas Electronics product, whether in whole or in part.
4. Descriptions of circuits, software and other related information in this document are provided only to illustrate the operation of semiconductor products and application examples. You are fully responsible for the incorporation of these circuits, software, and information in the design of your equipment. Renesas Electronics assumes no responsibility for any losses incurred by you or third parties arising from the use of these circuits, software, or information.
5. When exporting the products or technology described in this document, you should comply with the applicable export control laws and regulations and follow the procedures required by such laws and regulations. You should not use Renesas Electronics products or the technology described in this document for any purpose relating to military applications or use by the military, including but not limited to the development of weapons of mass destruction. Renesas Electronics products and technology may not be used for or incorporated into any products or systems whose manufacture, use, or sale is prohibited under any applicable domestic or foreign laws or regulations.
6. Renesas Electronics has used reasonable care in preparing the information included in this document, but Renesas Electronics does not warrant that such information is error free. Renesas Electronics assumes no liability whatsoever for any damages incurred by you resulting from errors in or omissions from the information included herein.
7. Renesas Electronics products are classified according to the following three quality grades: “Standard”, “High Quality”, and “Specific”. The recommended applications for each Renesas Electronics product depends on the product’s quality grade, as indicated below. You must check the quality grade of each Renesas Electronics product before using it in a particular application. You may not use any Renesas Electronics product for any application categorized as “Specific” without the prior written consent of Renesas Electronics. Further, you may not use any Renesas Electronics product for any application for which it is not intended without the prior written consent of Renesas Electronics. Renesas Electronics shall not be in any way liable for any damages or losses incurred by you or third parties arising from the use of any Renesas Electronics product for an application categorized as “Specific” or for which the product is not intended where you have failed to obtain the prior written consent of Renesas Electronics. The quality grade of each Renesas Electronics product is “Standard” unless otherwise expressly specified in a Renesas Electronics data sheets or data books, etc.
  - “Standard”: Computers; office equipment; communications equipment; test and measurement equipment; audio and visual equipment; home electronic appliances; machine tools; personal electronic equipment; and industrial robots.
  - “High Quality”: Transportation equipment (automobiles, trains, ships, etc.); traffic control systems; anti-disaster systems; anti-crime systems; safety equipment; and medical equipment not specifically designed for life support.
  - “Specific”: Aircraft; aerospace equipment; submersible repeaters; nuclear reactor control systems; medical equipment or systems for life support (e.g. artificial life support devices or systems), surgical implantations, or healthcare intervention (e.g. excision, etc.), and any other applications or purposes that pose a direct threat to human life.
8. You should use the Renesas Electronics products described in this document within the range specified by Renesas Electronics, especially with respect to the maximum rating, operating supply voltage range, movement power voltage range, heat radiation characteristics, installation and other product characteristics. Renesas Electronics shall have no liability for malfunctions or damages arising out of the use of Renesas Electronics products beyond such specified ranges.
9. Although Renesas Electronics endeavors to improve the quality and reliability of its products, semiconductor products have specific characteristics such as the occurrence of failure at a certain rate and malfunctions under certain use conditions. Further, Renesas Electronics products are not subject to radiation resistance design. Please be sure to implement safety measures to guard them against the possibility of physical injury, and injury or damage caused by fire in the event of the failure of a Renesas Electronics product, such as safety design for hardware and software including but not limited to redundancy, fire control and malfunction prevention, appropriate treatment for aging degradation or any other appropriate measures. Because the evaluation of microcomputer software alone is very difficult, please evaluate the safety of the final products or system manufactured by you.
10. Please contact a Renesas Electronics sales office for details as to environmental matters such as the environmental compatibility of each Renesas Electronics product. Please use Renesas Electronics products in compliance with all applicable laws and regulations that regulate the inclusion or use of controlled substances, including without limitation, the EU RoHS Directive. Renesas Electronics assumes no liability for damages or losses occurring as a result of your noncompliance with applicable laws and regulations.
11. This document may not be reproduced or duplicated, in any form, in whole or in part, without prior written consent of Renesas Electronics.
12. Please contact a Renesas Electronics sales office if you have any questions regarding the information contained in this document or Renesas Electronics products, or if you have any other inquiries.

(Note 1) “Renesas Electronics” as used in this document means Renesas Electronics Corporation and also includes its majority-owned subsidiaries.

(Note 2) “Renesas Electronics product(s)” means any product developed or manufactured by or for Renesas Electronics.

BIPOLAR ANALOG INTEGRATED CIRCUIT  
 **$\mu$ PC8172TB**

SILICON MMIC 2.5 GHz FREQUENCY UP-CONVERTER  
 FOR WIRELESS TRANSCEIVER

**DESCRIPTION**

The  $\mu$ PC8172TB is a silicon monolithic integrated circuit designed as frequency up-converter for wireless transceiver transmitter stage. This IC is manufactured using NEC's 30 GHz  $f_{max}$ . UHS0 (Ultra High Speed Process) silicon bipolar process.

This IC is as same circuit current as conventional  $\mu$ PC8106TB, but operates at higher frequency, higher gain and lower distortion. Consequently this IC is suitable for mobile communications.

**FEATURES**

- Recommended operating frequency :  $f_{RFout} = 0.8$  to 2.5 GHz
- Higher  $IP_3$  :  $CG = 9.5$  dB TYP.,  $OIP_3 = +7.5$  dBm TYP. @  $f_{RFout} = 0.9$  GHz
- High-density surface mounting : 6-pin super minimold package
- Supply voltage :  $V_{CC} = 2.7$  to 3.3 V

**APPLICATIONS**

- PCS1900M
- 2.4 GHz band transmitter/receiver system (wireless LAN etc.)

**ORDERING INFORMATION**

Part Number	Package	Marking	Supplying Form
$\mu$ PC8172TB-E3	6-pin super minimold	C3A	<ul style="list-style-type: none"> <li>• Embossed tape 8 mm wide.</li> <li>• Pin 1, 2, 3 face the tape perforation side.</li> <li>• Qty 3 kpcs/reel.</li> </ul>

**Remark** To order evaluation samples, please contact your local NEC sales office.  
 (Part number for sample order:  $\mu$ PC8172TB)

**Caution Electro-static sensitive devices**

The information in this document is subject to change without notice. Before using this document, please confirm that this is the latest version.  
 Not all devices/types available in every country. Please check with local NEC representative for availability and additional information.

**PIN CONNECTIONS**

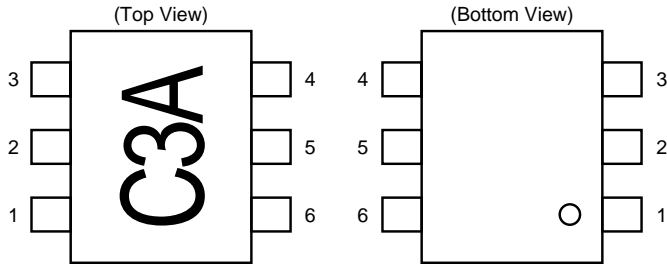

Pin No.	Pin Name
1	IFinput
2	GND
3	LOinput
4	PS
5	V <sub>CC</sub>
6	RFoutput

**SERIES PRODUCTS (T<sub>A</sub> = +25°C, V<sub>CC</sub> = V<sub>RFout</sub> = 3.0 V, Z<sub>s</sub> = Z<sub>L</sub> = 50 Ω)**

Part Number	I <sub>CC</sub> (mA)	f <sub>RFout</sub> (GHz)	CG (dB)		
			@RF 0.9 GHz <sup>Note</sup>	@RF 1.9 GHz	@RF 2.4 GHz
μPC8172TB	9	0.8 to 2.5	9.5	8.5	8.0
μPC8106TB	9	0.4 to 2.0	9	7	–
μPC8109TB	5	0.4 to 2.0	6	4	–
μPC8163TB	16.5	0.8 to 2.0	9	5.5	–

Part Number	P <sub>O(sat)</sub> (dBm)			OIP <sub>3</sub> (dBm)		
	@RF 0.9 GHz <sup>Note</sup>	@RF 1.9 GHz	@RF 2.4 GHz	@RF 0.9 GHz <sup>Note</sup>	@RF 1.9 GHz	@RF 2.4 GHz
μPC8172TB	+0.5	0	–0.5	+7.5	+6.0	+4.0
μPC8106TB	–2	–4	–	+5.5	+2.0	–
μPC8109TB	–5.5	–7.5	–	+1.5	–1.0	–
μPC8163TB	+0.5	–2	–	+9.5	+6.0	–

**Note** f<sub>RFout</sub> = 0.83 GHz @ μPC8163TB

**Remark** Typical performance. Please refer to **ELECTRICAL CHARACTERISTICS** in detail.  
To know the associated product, please refer to each latest data sheet.

**BLOCK DIAGRAM (FOR THE μPC8172TB)**

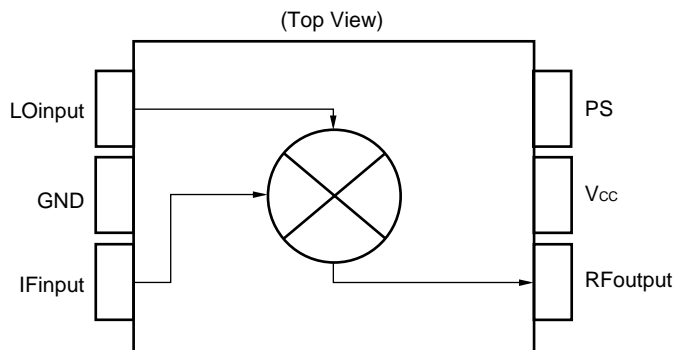

SYSTEM APPLICATION EXAMPLES (SCHEMATICS OF IC LOCATION IN THE SYSTEM)

Wireless Transceiver

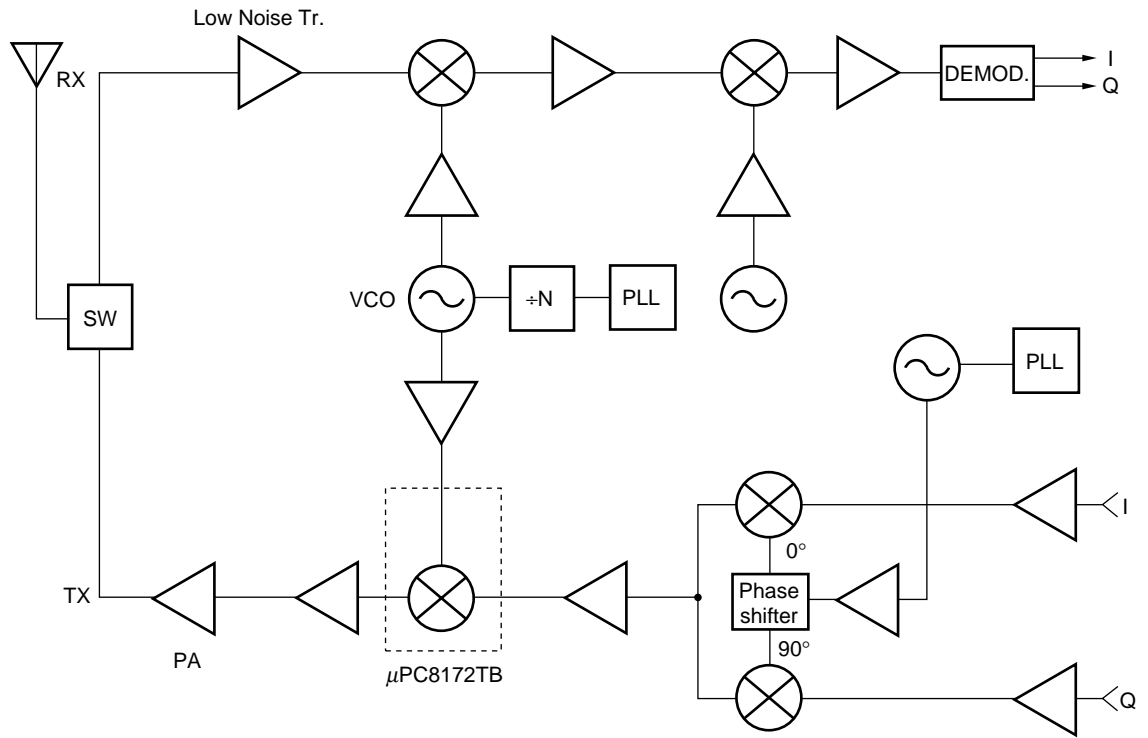

To know the associated products, please refer to each latest data sheet.

**CONTENTS**

1. PIN EXPLANATION..... 5

2. ABSOLUTE MAXIMUM RATINGS..... 6

3. RECOMMENDED OPERATING CONDITIONS..... 6

4. ELECTRICAL CHARACTERISTICS ..... 6

5. OTHER CHARACTERISTICS, FOR REFERENCE PURPOSES ONLY..... 7

6. TEST CIRCUIT ..... 8

    6.1 TEST CIRCUIT 1 ( $f_{RFout} = 900 \text{ MHz}$ )..... 8

    6.2 TEST CIRCUIT 2 ( $f_{RFout} = 1.9 \text{ GHz}$ )..... 9

    6.3 TEST CIRCUIT 3 ( $f_{RFout} = 2.4 \text{ GHz}$ )..... 10

7. TYPICAL CHARACTERISTICS..... 12

8. PACKAGE DIMENSIONS..... 24

9. NOTE ON CORRECT USE..... 25

10. RECOMMENDED SOLDERING CONDITIONS..... 25

1. PIN EXPLANATION

Pin No.	Pin Name	Applied Voltage (V)	Pin Voltage (V) <sup>Note</sup>	Function and Explanation	Equivalent Circuit						
1	IFinput	–	1.4	This pin is IF input to double balanced mixer (DBM). The input is designed as high impedance. The circuit contributes to suppress spurious signal. Also this symmetrical circuit can keep specified performance insensitive to process-condition distribution. For above reason, double balanced mixer is adopted.							
2	GND	GND	–	GND pin. Ground pattern on the board should be formed as wide as possible. Track Length should be kept as short as possible to minimize ground impedance.							
3	LOinput	–	2.3	Local input pin. Recommendable input level is –10 to 0 dBm.							
5	Vcc	2.7 to 3.3	–	Supply voltage pin.							
6	RFoutput	Same bias as Vcc through external inductor	–	This pin is RF output from DBM. This pin is designed as open collector. Due to the high impedance output, this pin should be externally equipped with LC matching circuit to next stage.							
4	PS	Vcc/GND	–	Power save control pin. Bias controls operation as follows. <table border="1" style="margin: 10px auto;"> <thead> <tr> <th>Pin bias</th> <th>Control</th> </tr> </thead> <tbody> <tr> <td>Vcc</td> <td>Operation</td> </tr> <tr> <td>GND</td> <td>Power Save</td> </tr> </tbody> </table>	Pin bias	Control	Vcc	Operation	GND	Power Save	
Pin bias	Control										
Vcc	Operation										
GND	Power Save										

**Note** Each pin voltage is measured with  $V_{CC} = V_{PS} = V_{RFout} = 3.0\text{ V}$ .

★ 2. ABSOLUTE MAXIMUM RATINGS

Parameter	Symbol	Test Conditions	Rating	Unit
Supply Voltage	V <sub>CC</sub>	T <sub>A</sub> = +25°C	3.6	V
PS pin Input Voltage	V <sub>PS</sub>	T <sub>A</sub> = +25°C	3.6	V
Power Dissipation of Package	P <sub>D</sub>	Mounted on double-side copperclad 50 × 50 × 1.6 mm epoxy glass PWB (T <sub>A</sub> = +85°C)	270	mW
Operating Ambient Temperature	T <sub>A</sub>		−40 to +85	°C
Storage Temperature	T <sub>stg</sub>		−55 to +150	°C
Input Power	P <sub>in</sub>		+10	dBm

3. RECOMMENDED OPERATING CONDITIONS

Parameter	Symbol	Test Conditions	MIN.	TYP.	MAX.	Unit
Supply Voltage	V <sub>CC</sub>	The same voltage should be applied to pin 5 and 6	2.7	3.0	3.3	V
Operating Ambient Temperature	T <sub>A</sub>		−40	+25	+85	°C
Local Input Level	P <sub>LOin</sub>	Z <sub>s</sub> = 50 Ω (without matching)	−10	−5	0	dBm
RF Output Frequency	f <sub>RFout</sub>	With external matching circuit	0.8	–	2.5	GHz
IF Input Frequency	f <sub>IFin</sub>		50	–	400	MHz

4. ELECTRICAL CHARACTERISTICS

(T<sub>A</sub> = +25°C, V<sub>CC</sub> = V<sub>RFout</sub> = 3.0 V, f<sub>IFin</sub> = 240 MHz, P<sub>LOin</sub> = −5 dBm, and V<sub>PS</sub> ≥ 2.7 V unless otherwise specified)

Parameter	Symbol	Test Conditions <sup>Note</sup>	MIN.	TYP.	MAX.	Unit
Circuit Current	I <sub>CC</sub>	No Signal	5.5	9.0	13	mA
Circuit Current In Power Save Mode	I <sub>CC(PS)</sub>	V <sub>PS</sub> = 0 V	–	–	2	μA
Conversion Gain	CG1	f <sub>RFout</sub> = 0.9 GHz, P <sub>IFin</sub> = −30 dBm	6.5	9.5	12.5	dB
	CG2	f <sub>RFout</sub> = 1.9 GHz, P <sub>IFin</sub> = −30 dBm	5.5	8.5	11.5	dB
	CG3	f <sub>RFout</sub> = 2.4 GHz, P <sub>IFin</sub> = −30 dBm	5	8.0	11.0	dB
Saturated RF Output Power	P <sub>O(sat)1</sub>	f <sub>RFout</sub> = 0.9 GHz, P <sub>IFin</sub> = 0 dBm	−2.5	+0.5	–	dBm
	P <sub>O(sat)2</sub>	f <sub>RFout</sub> = 1.9 GHz, P <sub>IFin</sub> = 0 dBm	−3.5	0	–	dBm
	P <sub>O(sat)3</sub>	f <sub>RFout</sub> = 2.4 GHz, P <sub>IFin</sub> = 0 dBm	−4	−0.5	–	dBm

**Note** f<sub>RFout</sub> < f<sub>LOin</sub> @ f<sub>RFout</sub> = 0.9 GHz

f<sub>LOin</sub> < f<sub>RFout</sub> @ f<sub>RFout</sub> = 1.9 GHz/2.4 GHz



**5. OTHER CHARACTERISTICS, FOR REFERENCE PURPOSES ONLY**

(T<sub>A</sub> = +25°C, V<sub>CC</sub> = V<sub>RFout</sub> = 3.0 V, P<sub>LOin</sub> = -5 dBm, and V<sub>PS</sub> ≥ 2.7 V unless otherwise specified)

Parameter		Symbol	Test Conditions <sup>Note</sup>	Data	Unit
Output Third-Order Distortion Intercept Point		OIP <sub>31</sub>	f <sub>RFout</sub> = 0.9 GHz	+7.5	dBm
		OIP <sub>32</sub>	f <sub>RFout</sub> = 1.9 GHz		
		OIP <sub>33</sub>	f <sub>RFout</sub> = 2.4 GHz		
			f <sub>Fin1</sub> = 240 MHz f <sub>Fin2</sub> = 241 MHz	+6.0	dBm
				+4.0	dBm
Input Third-Order Distortion Intercept Point		IIP <sub>31</sub>	f <sub>RFout</sub> = 0.9 GHz	-2.0	dBm
		IIP <sub>32</sub>	f <sub>RFout</sub> = 1.9 GHz		
		IIP <sub>33</sub>	f <sub>RFout</sub> = 2.4 GHz		
			f <sub>Fin1</sub> = 240 MHz f <sub>Fin2</sub> = 241 MHz	-2.5	dBm
				-4.0	dBm
SSB Noise Figure		SSB•NF1	f <sub>RFout</sub> = 0.9 GHz, f <sub>Fin</sub> = 240 MHz	9.5	dB
		SSB•NF2	f <sub>RFout</sub> = 1.9 GHz, f <sub>Fin</sub> = 240 MHz	10.4	dB
		SSB•NF3	f <sub>RFout</sub> = 2.4 GHz, f <sub>Fin</sub> = 240 MHz	10.6	dB
Power Save Response Time	Rise time	T <sub>PS(rise)</sub>	V <sub>PS</sub> : GND → V <sub>CC</sub>	1	μs
	Fall time	T <sub>PS(fall)</sub>	V <sub>PS</sub> : V <sub>CC</sub> → GND	1.5	μs

**Note** f<sub>RFout</sub> < f<sub>LOin</sub> @ f<sub>RFout</sub> = 0.9 GHz  
 f<sub>LOin</sub> < f<sub>RFout</sub> @ f<sub>RFout</sub> = 1.9 GHz/2.4 GHz

6. TEST CIRCUIT

★ 6.1 TEST CIRCUIT 1 (f<sub>RFout</sub> = 900 MHz)

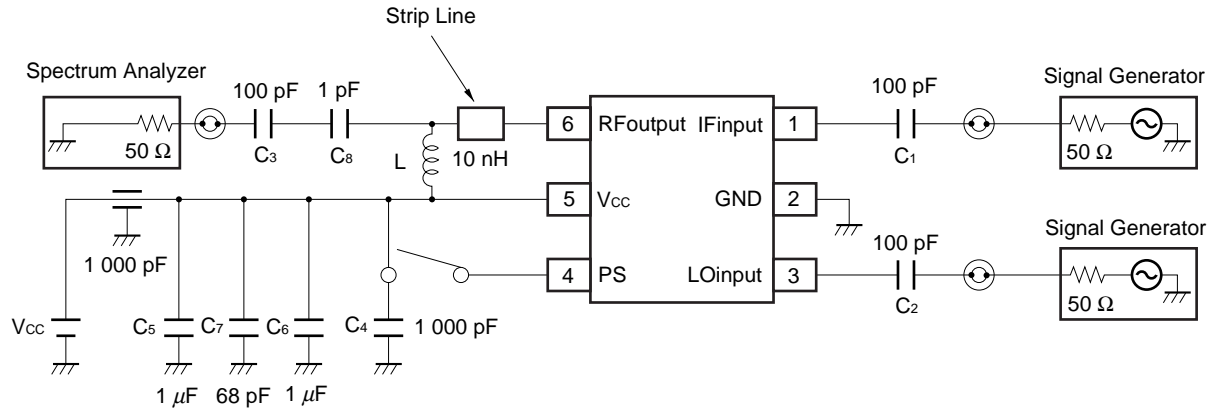

EXAMPLE OF TEST CIRCUIT 1 ASSEMBLED ON EVALUATION BOARD

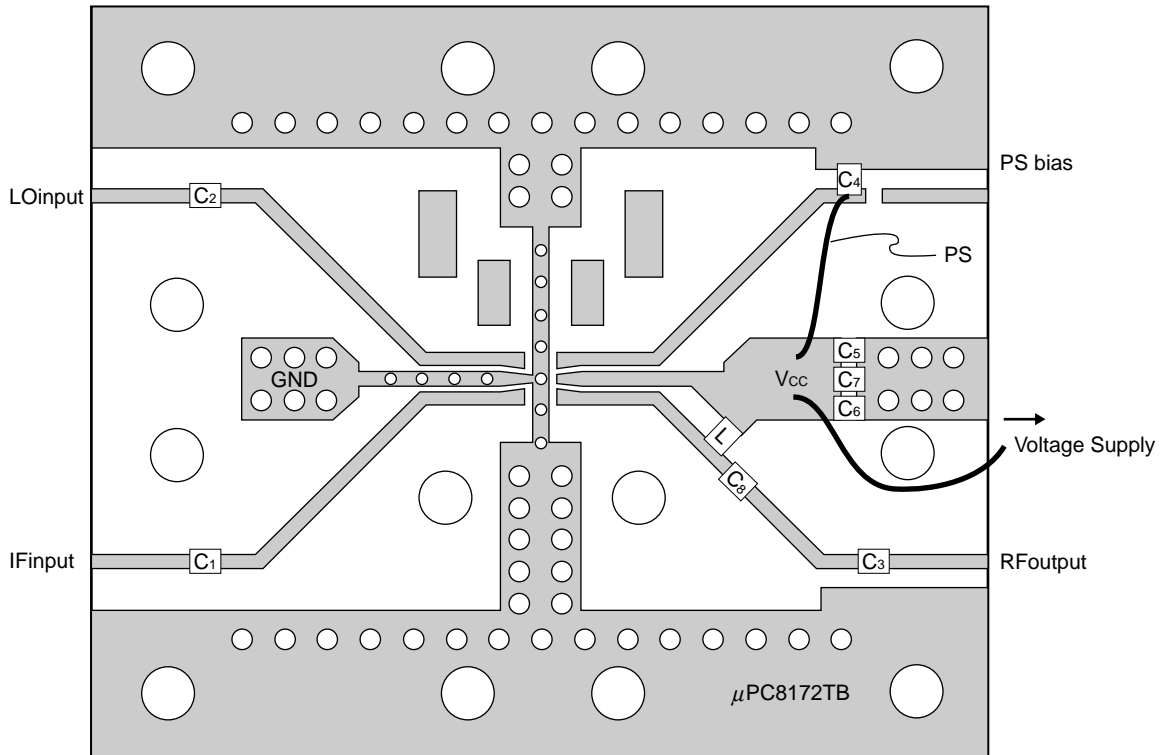

COMPONENT LIST

Form	Symbol	Value
Chip capacitor	C <sub>1</sub> , C <sub>2</sub> , C <sub>3</sub>	100 pF
	C <sub>4</sub>	1 000 pF
	C <sub>5</sub> , C <sub>6</sub>	1 μF
	C <sub>7</sub>	68 pF
	C <sub>8</sub>	1 pF
Chip inductor	L	10 nH <sup>Note</sup>

- (\*1) 35 × 42 × 0.4 mm polyimide board, double-sided copper clad
- (\*2) Ground pattern on rear of the board
- (\*3) Solder plated patterns
- (\*4) ○○: Through holes

Note 10 nH: LL1608-FH10N (TOKO Co., Ltd.)

★ 6.2 TEST CIRCUIT 2 ( $f_{RFout} = 1.9\text{ GHz}$ )

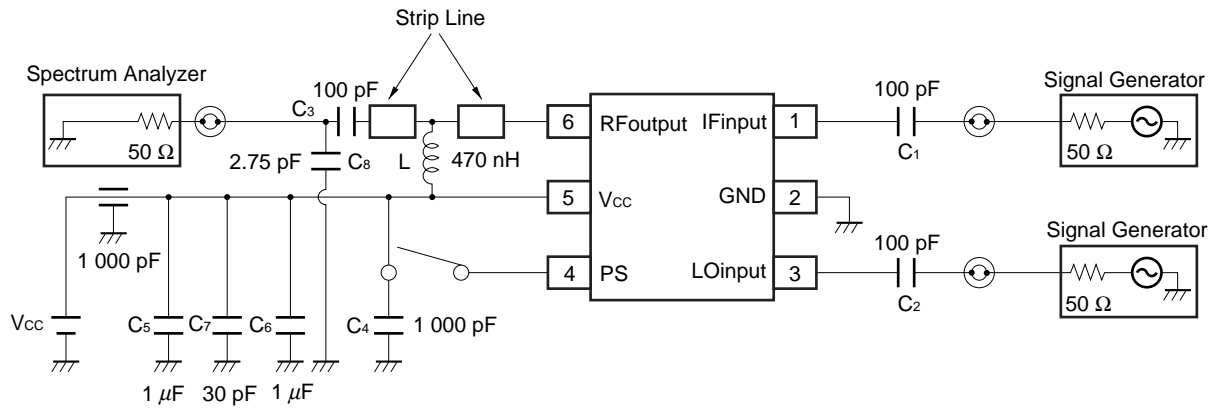

EXAMPLE OF TEST CIRCUIT 2 ASSEMBLED ON EVALUATION BOARD

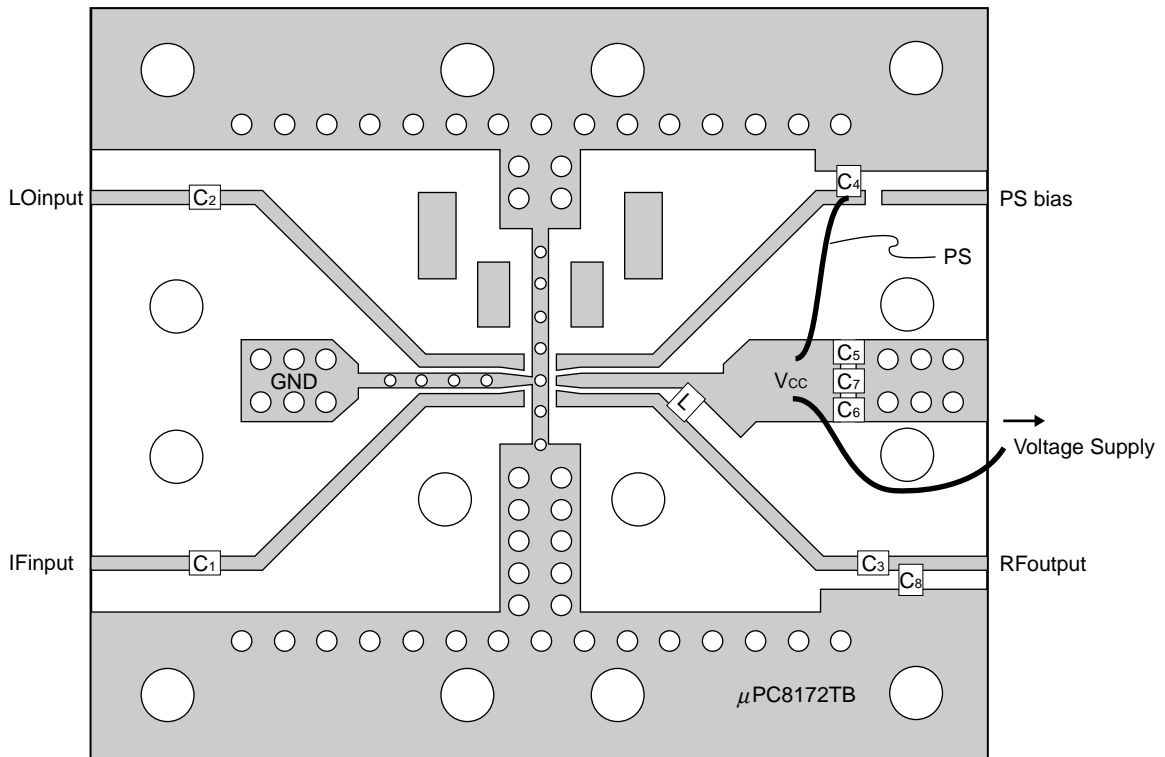

COMPONENT LIST

Form	Symbol	Value
Chip capacitor	C <sub>1</sub> , C <sub>2</sub> , C <sub>3</sub>	100 pF
	C <sub>4</sub>	1 000 pF
	C <sub>5</sub> , C <sub>6</sub>	1 μF
	C <sub>7</sub>	30 pF
	C <sub>8</sub>	2.75 pF
Chip inductor	L	470 nH <sup>Note</sup>

- (\*1) 35 × 42 × 0.4 mm polyimide board, double-sided copper clad
- (\*2) Ground pattern on rear of the board
- (\*3) Solder plated patterns
- (\*4) ○ ○ ○: Through holes

Note 470 nH: LL2012-FR47 (TOKO Co., Ltd.)

★ 6.3 TEST CIRCUIT 3 (f<sub>RFout</sub> = 2.4 GHz)

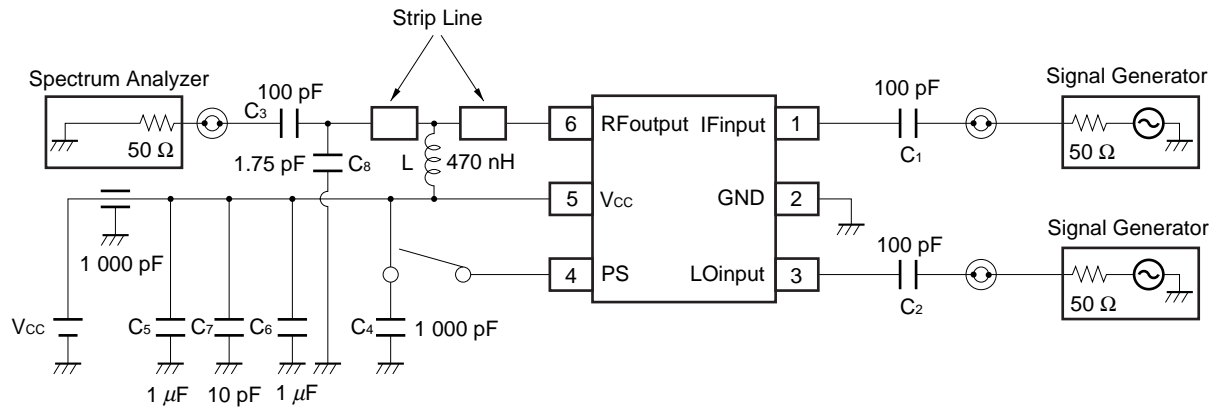

EXAMPLE OF TEST CIRCUIT 3 ASSEMBLED ON EVALUATION BOARD

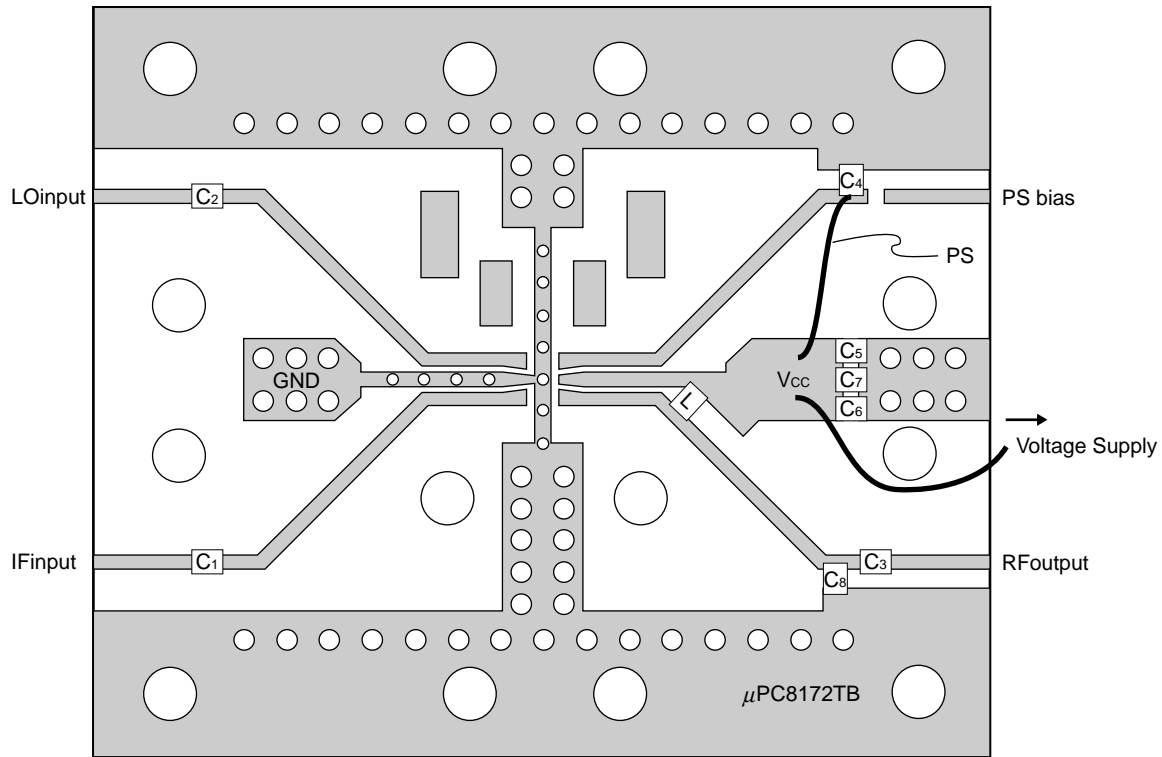

COMPONENT LIST

Form	Symbol	Value
Chip capacitor	C <sub>1</sub> , C <sub>2</sub> , C <sub>3</sub>	100 pF
	C <sub>4</sub>	1 000 pF
	C <sub>5</sub> , C <sub>6</sub>	1 μF
	C <sub>7</sub>	10 pF
	C <sub>8</sub>	1.75 pF
	Chip inductor	L

- (\*1) 35 × 42 × 0.4 mm polyimide board, double-sided copper clad
- (\*2) Ground pattern on rear of the board
- (\*3) Solder plated patterns
- (\*4) ○○: Through holes

Note 470 nH: LL2012-FR47 (TOKO Co., Ltd.)

**Caution** The test circuits and board pattern on data sheet are for performance evaluation use only (They are not recommended circuits). In the case of actual design-in, matching circuit should be determined using S-parameter of desired frequency in accordance to actual mounting pattern.

★ 7. TYPICAL CHARACTERISTICS (Unless otherwise specified,  $T_A = +25^\circ\text{C}$ ,  $V_{CC} = V_{RFout}$ )

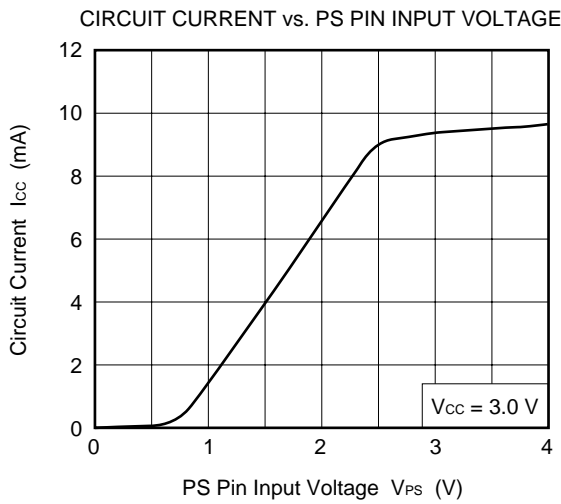
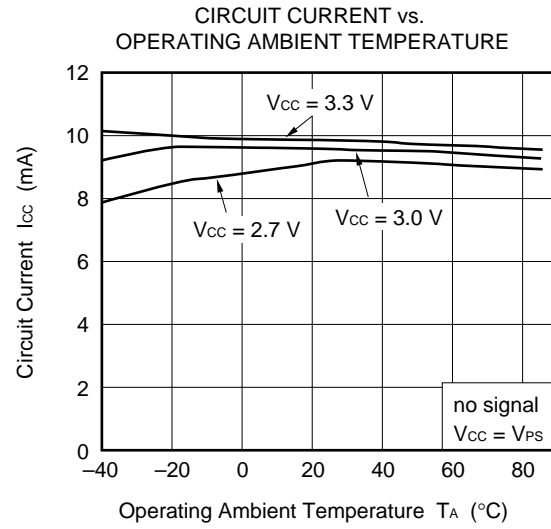
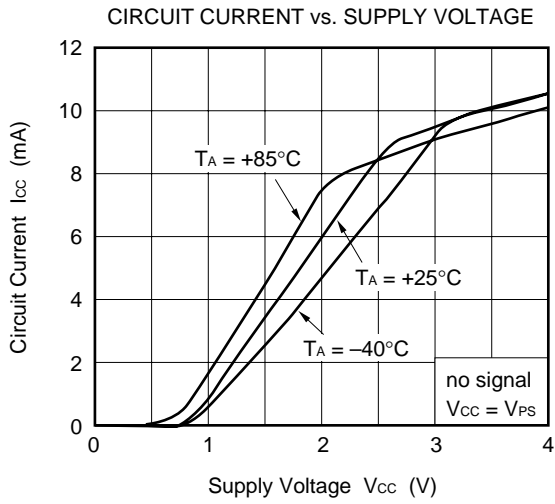

PS PIN CONTROL RESPONSE TIME

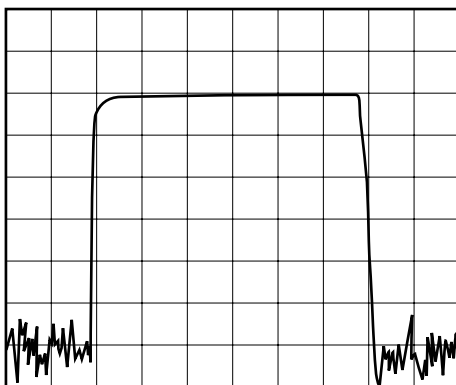

REF LVL = 0 dBm  
 ATT = 10 dB  
 10 dB/DIV (Vertical axis)  
 CENTER = 0.9 GHz  
 SPAN = 0 Hz  
 RBW = 3 MHz  
 VBW = 3 MHz  
 SWP = 50  $\mu\text{sec}$   
 5  $\mu\text{sec}$ /DIV (Horizontal axis)

★ **S-PARAMETERS FOR EACH PORT** ( $V_{CC} = V_{PS} = V_{RFout} = 3.0\text{ V}$ )  
 (The parameters are monitored at DUT pins)

LO port

$S_{11}$  Z  
 REF 1.0 Units  
 1 200.0 mUnits/  
 ▽ 21.625 Ω -91.148 Ω  
 hp

MARKER 1  
 1.15 GHz  
 MARKER 2  
 1.65 GHz  
 MARKER 3  
 2.15 GHz

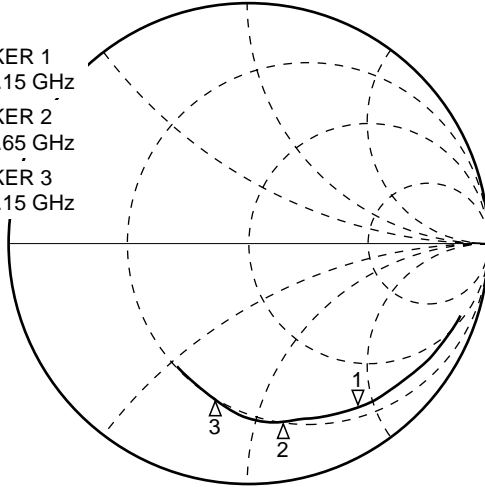

START 0.400000000 GHz  
 STOP 2.500000000 GHz

RF port (without matching)

$S_{22}$  Z  
 REF 1.0 Units  
 1 200.0 mUnits/  
 ▽ 71.5 Ω -240.34 Ω  
 hp

MARKER 1  
 900.0 MHz  
 MARKER 2  
 1.9 GHz  
 MARKER 3  
 2.5 GHz

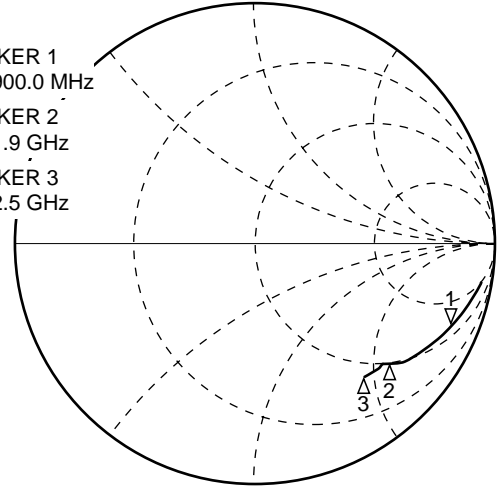

START 0.400000000 GHz  
 STOP 2.500000000 GHz

IF port

$S_{11}$  Z  
 REF 1.0 Units  
 1 200.0 mUnits/  
 ▽ 332.63 Ω -601.34 Ω  
 hp

MARKER 1  
 240.0 MHz

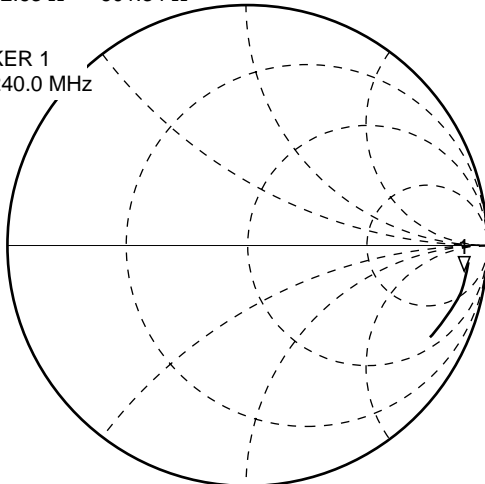

START 0.100000000 GHz  
 STOP 1.000000000 GHz

★ S-PARAMETERS FOR MATCHED RF OUTPUT ( $V_{CC} = V_{PS} = V_{RFout} = 3.0\text{ V}$ ) –ON EVALUATION BOARD–  
 (S22 data are monitored at RF connector on board)

900 MHz (matched in test circuit 1)

S22 Z  
 REF 1.0 Units  
 1 200.0 mUnits/  
 $\nabla$  55.615  $\Omega$  2.2849  $\Omega$   
 hp

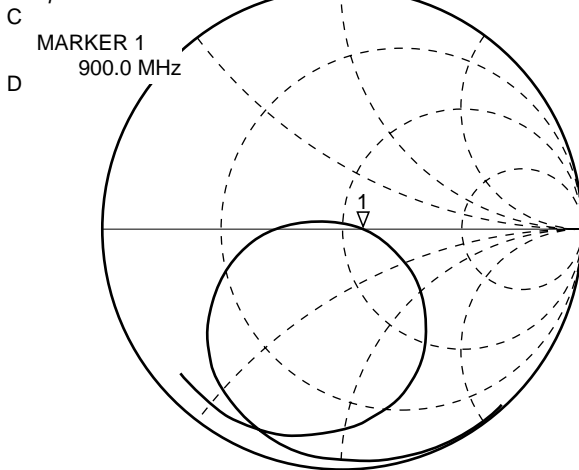

START 0.40000000 GHz  
 STOP 1.40000000 GHz

1.9 GHz (matched in test circuit 2)

S22 Z  
 REF 1.0 Units  
 1 200.0 mUnits/  
 $\nabla$  38.584  $\Omega$  -2.2656  $\Omega$   
 hp

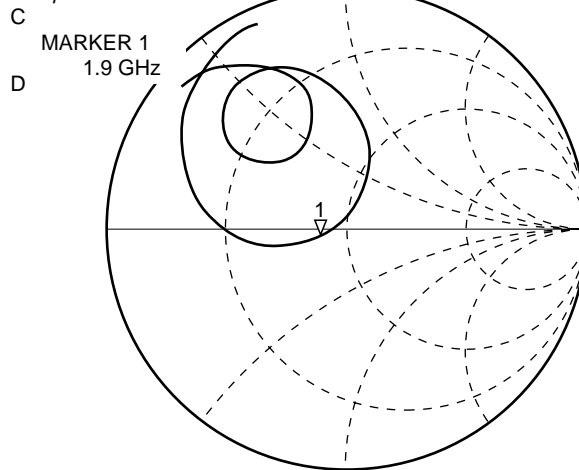

START 1.40000000 GHz  
 STOP 2.40000000 GHz

S22 log MAG.  
 REF 0.0 dB  
 1 10.0 dB/  
 $\nabla$  -24.754 dB  
 hp

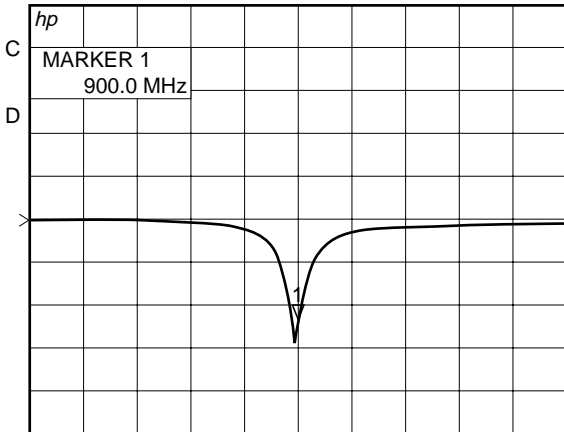

START 0.40000000 GHz  
 STOP 1.40000000 GHz

S22 log MAG.  
 REF 0.0 dB  
 1 10.0 dB/  
 $\nabla$  -18.196 dB  
 hp

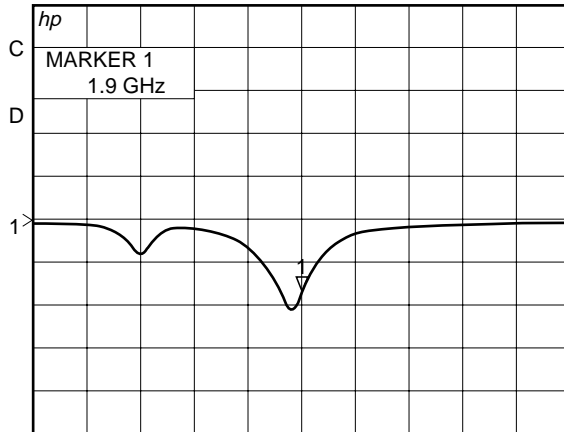

START 1.40000000 GHz  
 STOP 2.40000000 GHz



★ **S-PARAMETERS FOR MATCHED RF OUTPUT ( $V_{CC} = V_{PS} = V_{RFout} = 3.0\text{ V}$ ) –ON EVALUATION BOARD–**  
**( $S_{22}$  data are monitored at RF connector on board)**

2.4 GHz (matched in test circuit 3)

$S_{22}$  Z  
REF 1.0 Units  
1 200.0 mUnits/  
∇ 47.975 Ω -7.1113 Ω  
hp

C MARKER 1  
D 2.4 GHz

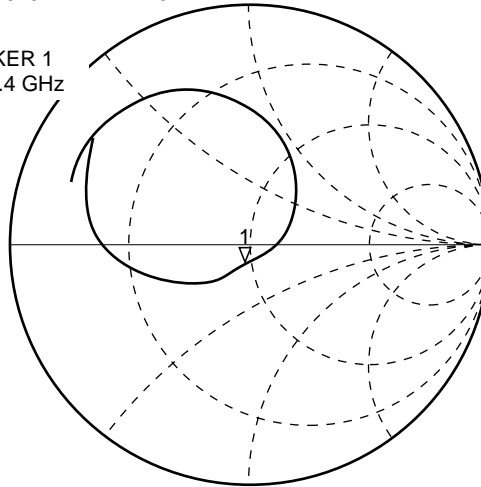

START 1.900000000 GHz  
STOP 2.900000000 GHz

$S_{22}$  log MAG.  
REF 0.0 dB  
1 10.0 dB/  
∇ -22.326 dB  
hp

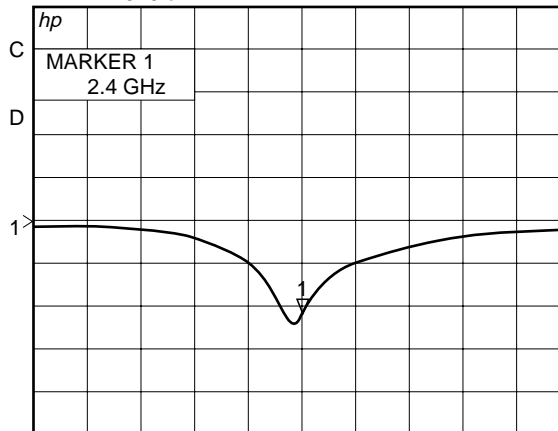

START 1.900000000 GHz  
STOP 2.900000000 GHz

CONVERSION GAIN vs. LOCAL INPUT LEVEL

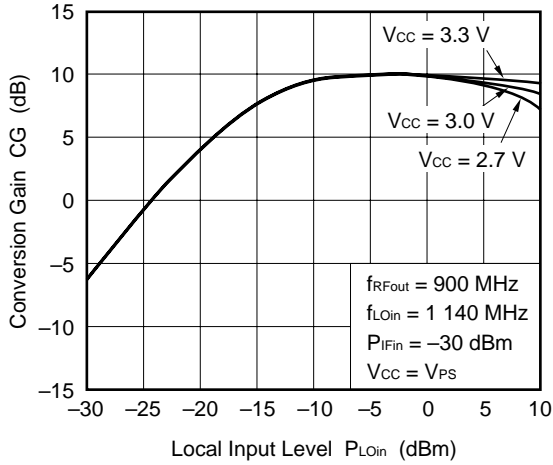

RF OUTPUT LEVEL vs. IF INPUT LEVEL

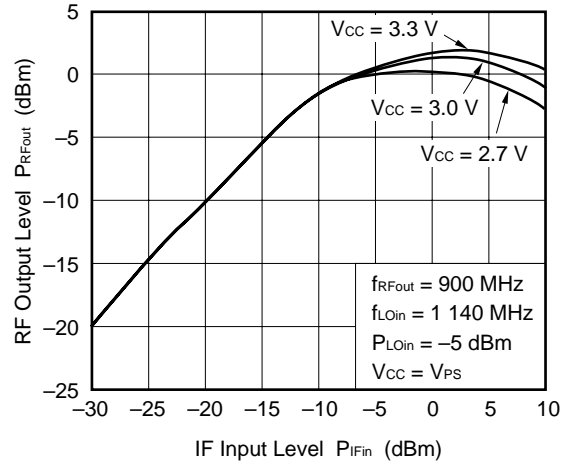

CONVERSION GAIN vs. LOCAL INPUT LEVEL

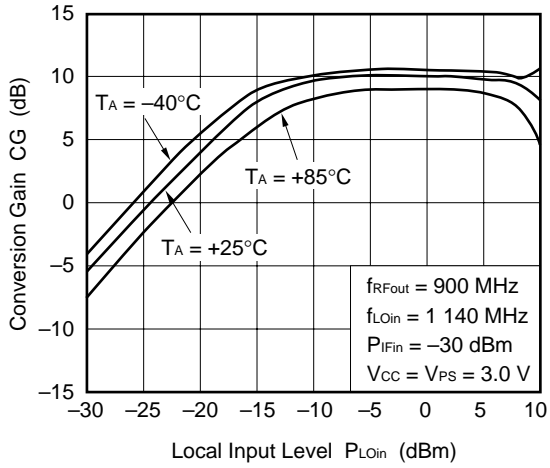

RF OUTPUT LEVEL vs. IF INPUT LEVEL

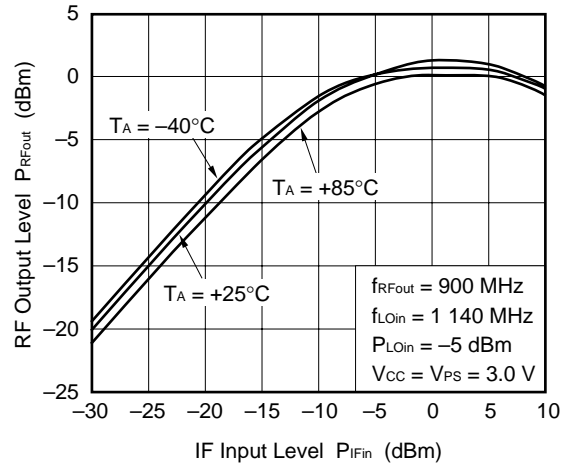

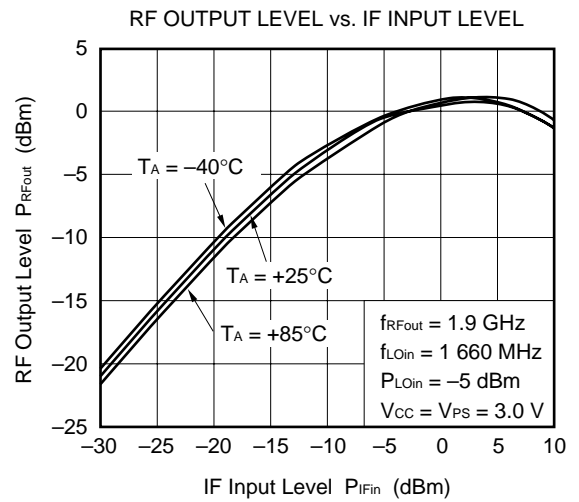
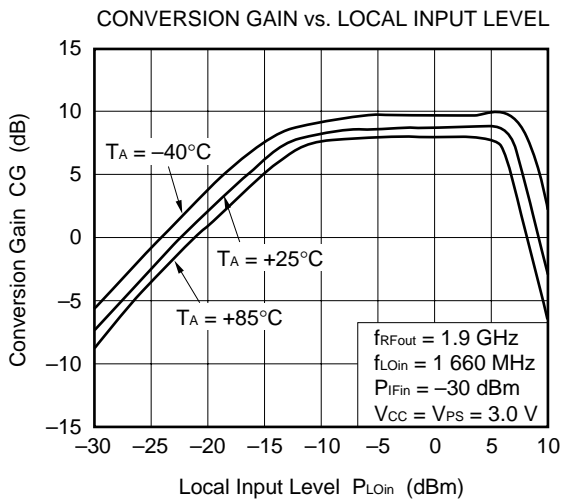
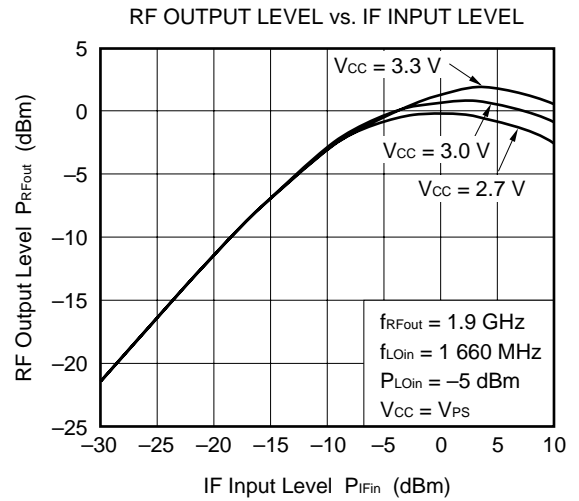
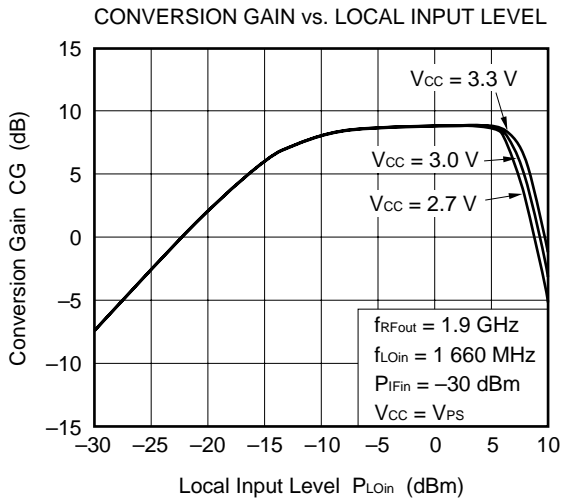

CONVERSION GAIN vs. LOCAL INPUT LEVEL

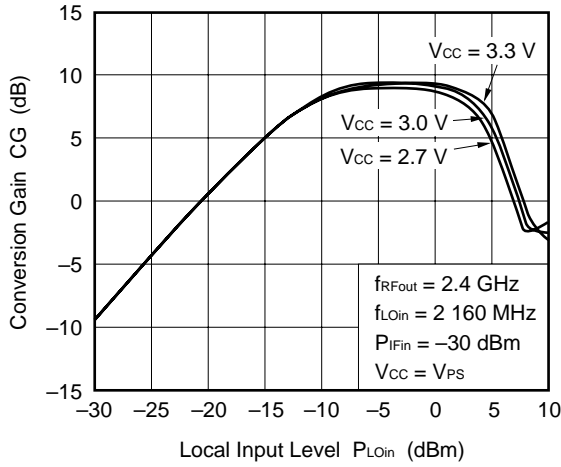

RF OUTPUT LEVEL vs. IF INPUT LEVEL

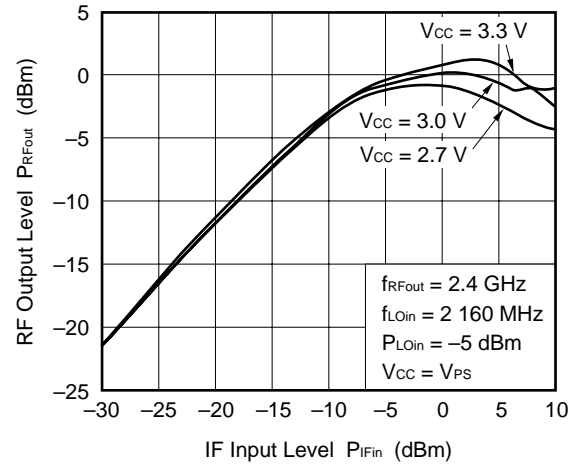

CONVERSION GAIN vs. LOCAL INPUT LEVEL

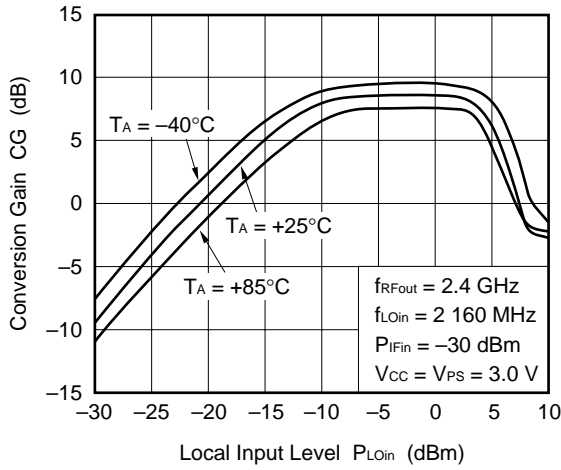

RF OUTPUT LEVEL vs. IF INPUT LEVEL

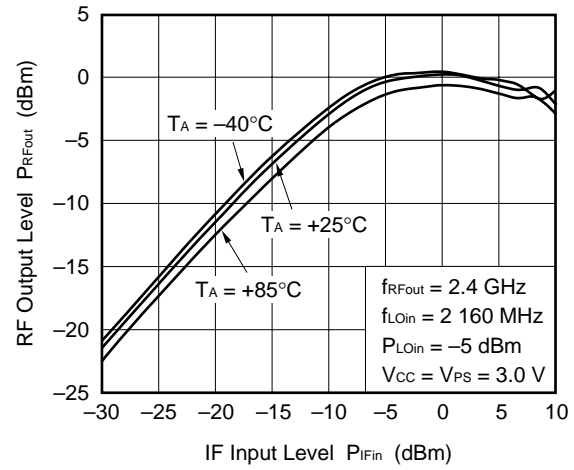

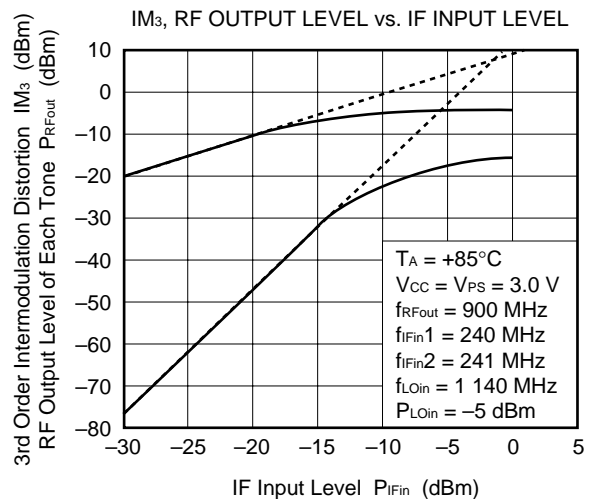
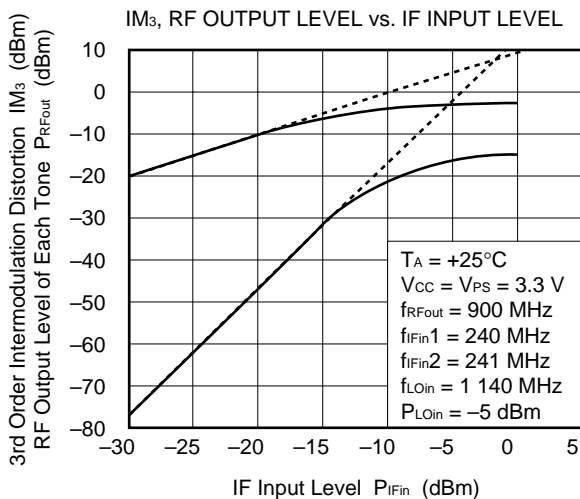
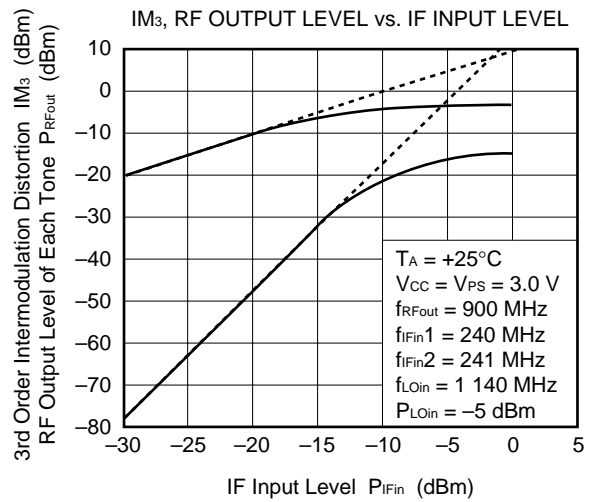
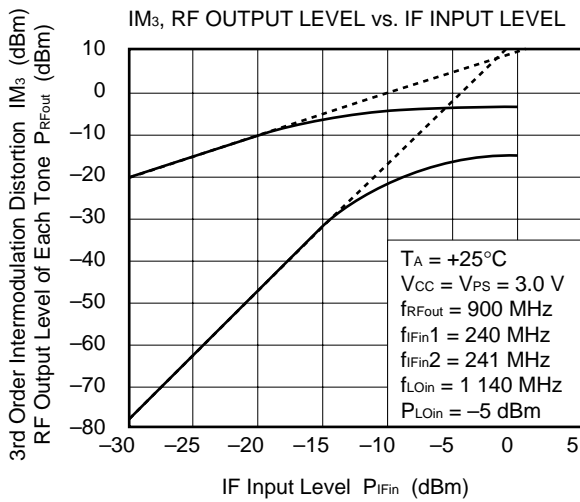
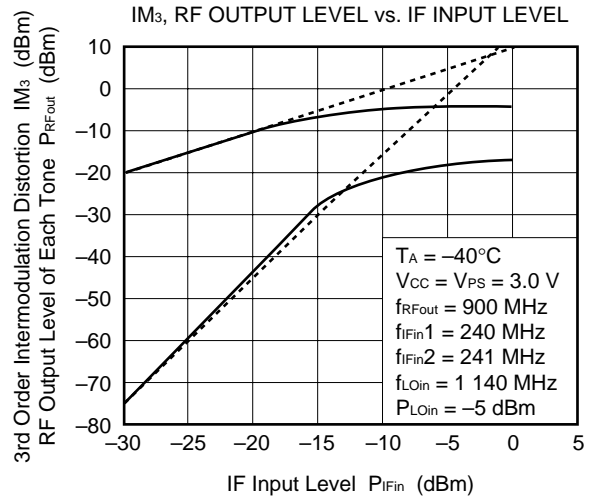
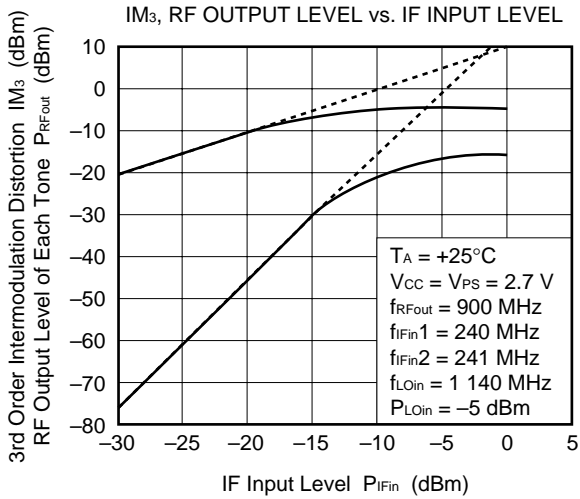

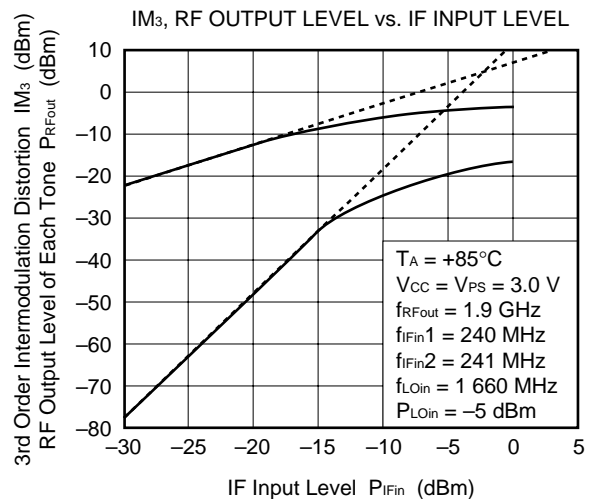
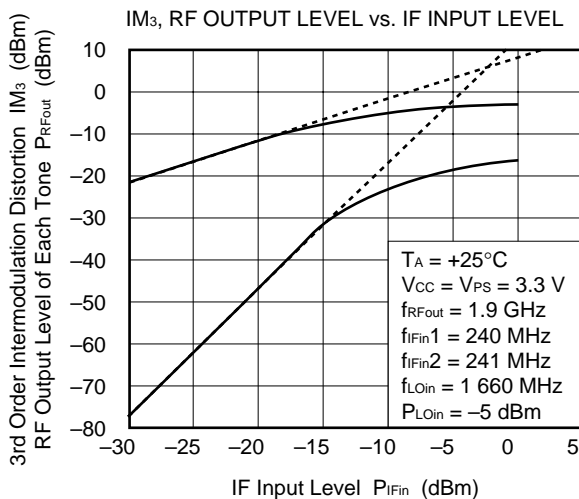
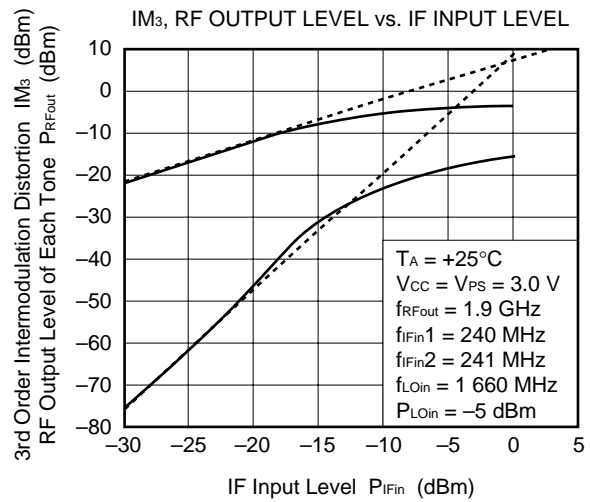
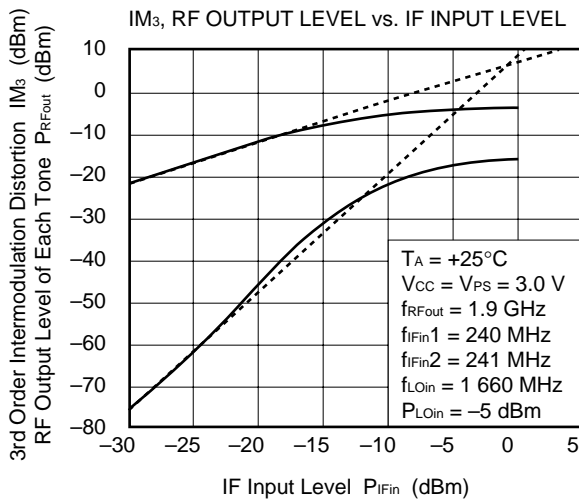
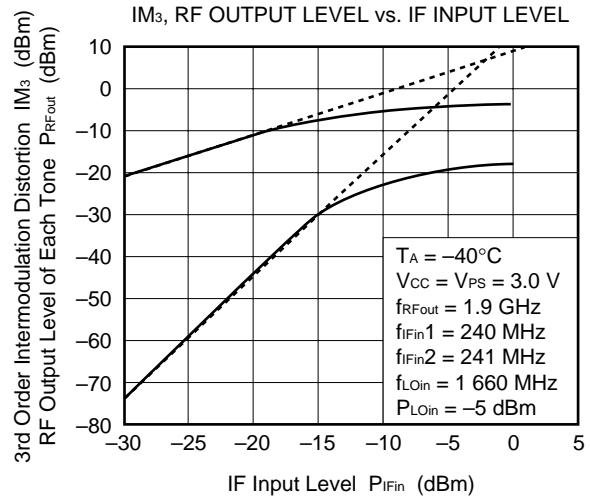
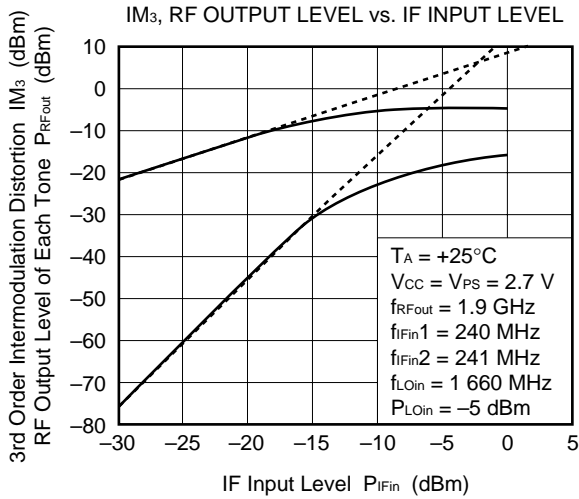

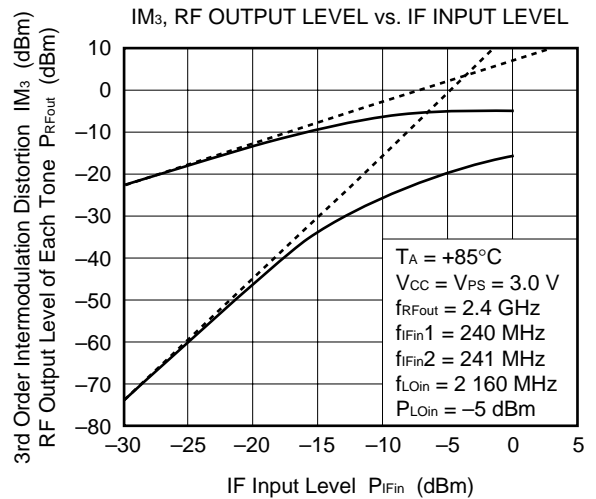
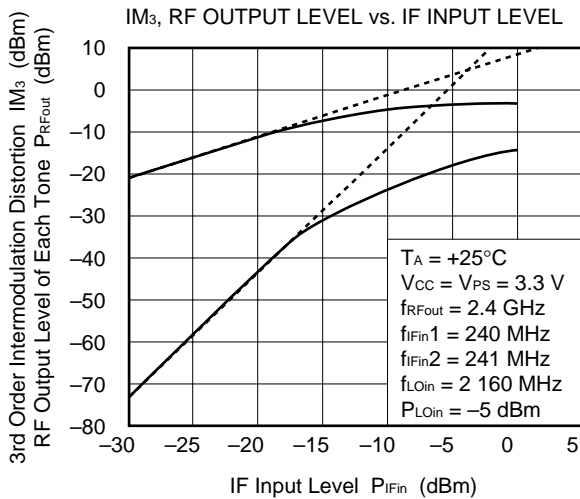
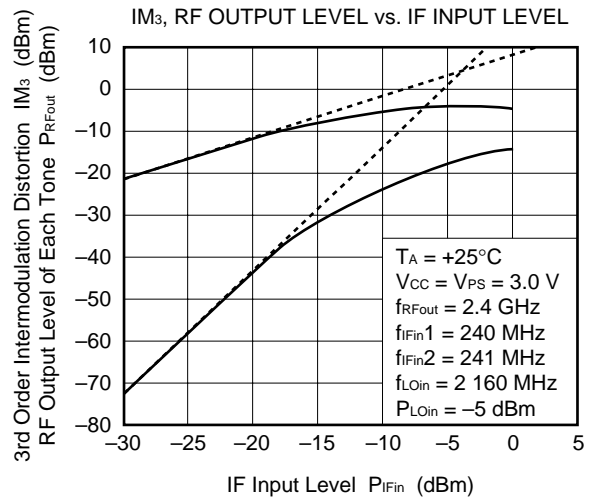
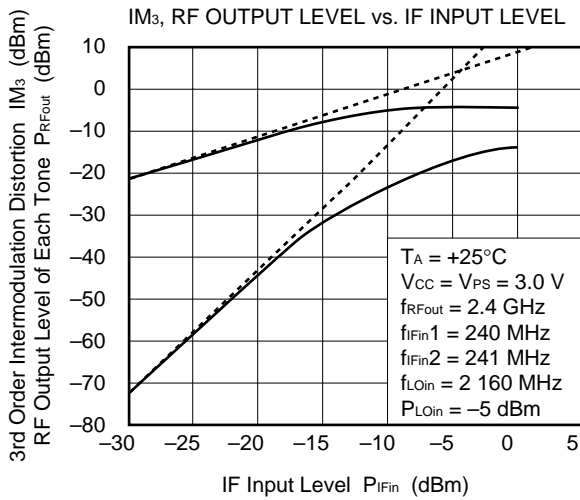
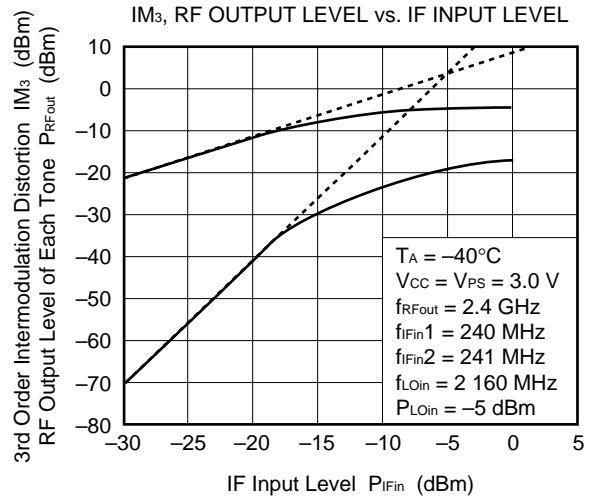
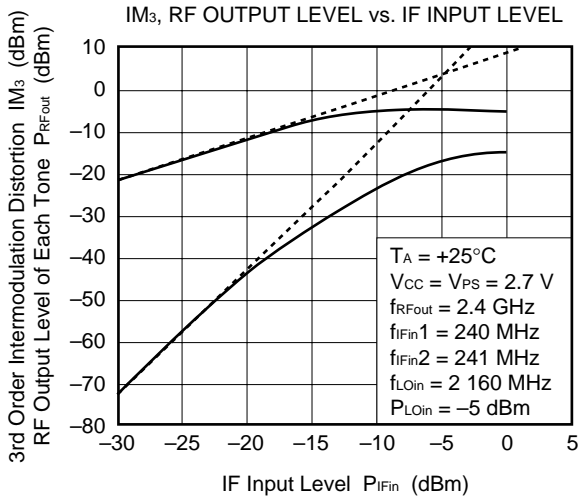

LOCAL LEAKAGE AT IF PIN vs.  
LOCAL INPUT FREQUENCY

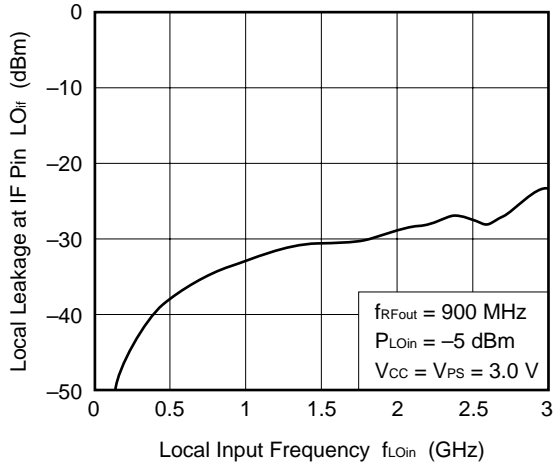

LOCAL LEAKAGE AT IF PIN vs.  
LOCAL INPUT FREQUENCY

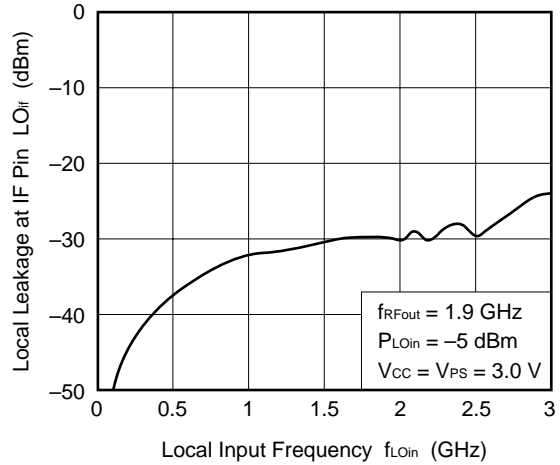

LOCAL LEAKAGE AT RF PIN vs.  
LOCAL INPUT FREQUENCY

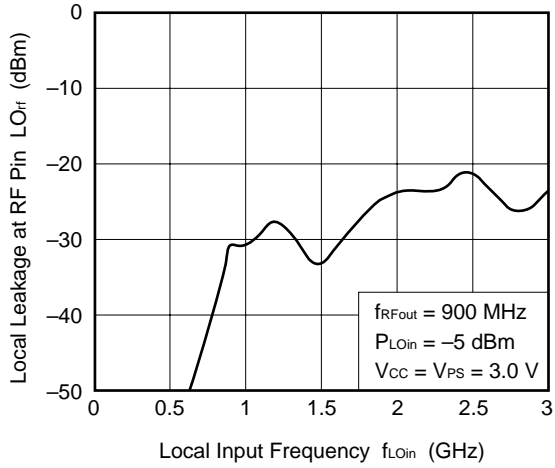

LOCAL LEAKAGE AT RF PIN vs.  
LOCAL INPUT FREQUENCY

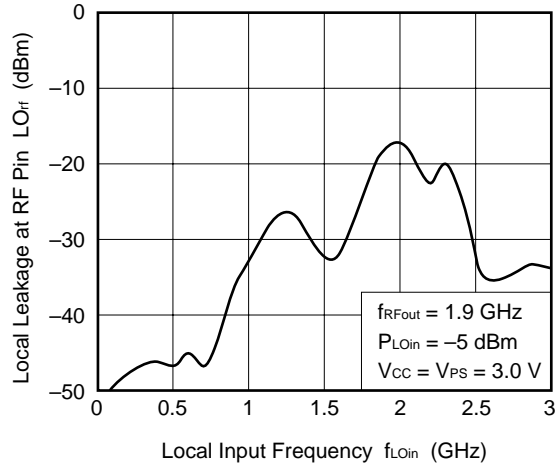

IF LEAKAGE AT RF PIN vs.  
IF INPUT FREQUENCY

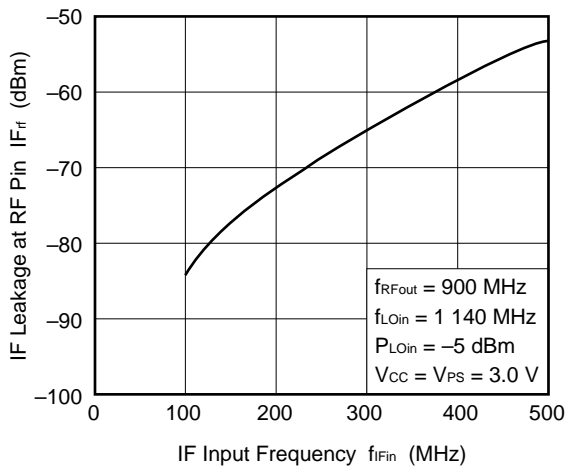

IF LEAKAGE AT RF PIN vs.  
IF INPUT FREQUENCY

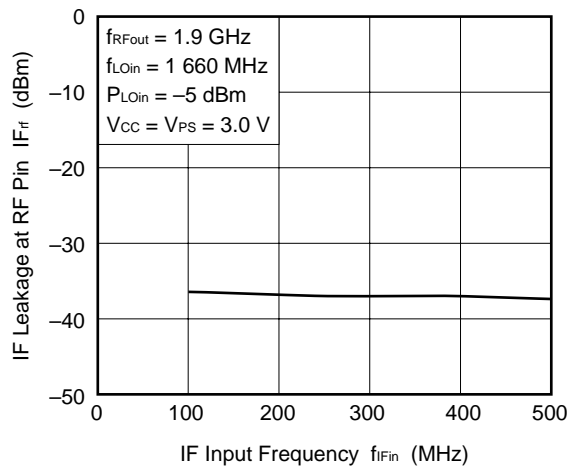



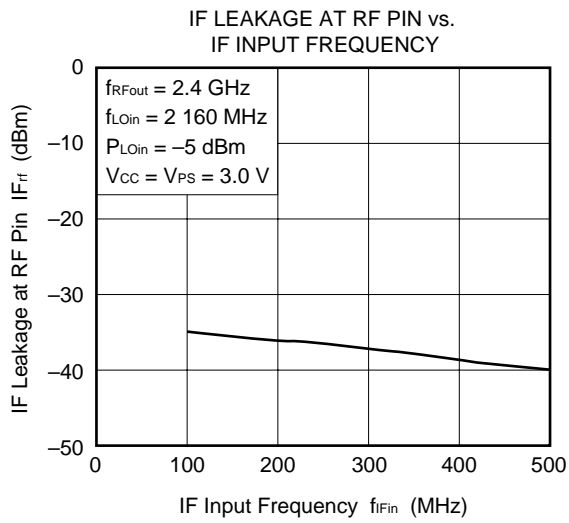
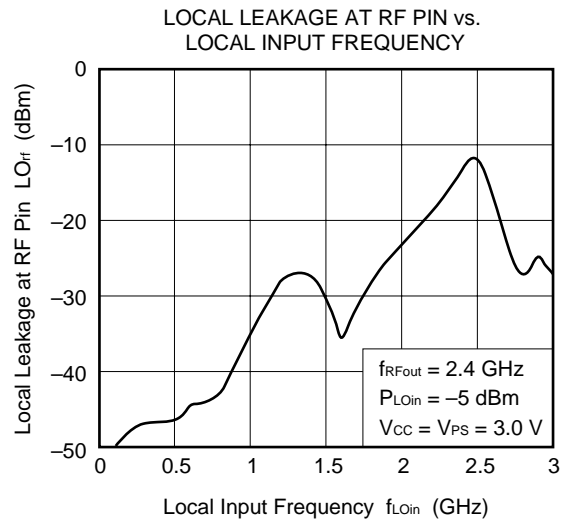
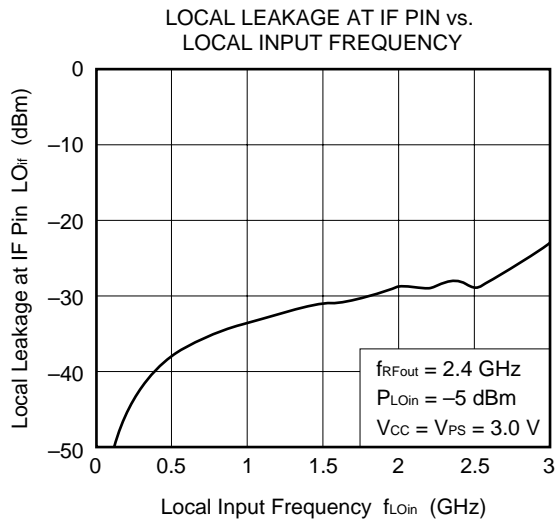

**Remark** The graphs indicate nominal characteristics.

★ 8. PACKAGE DIMENSIONS

6-PIN SUPER MINIMOLD (UNIT: mm)

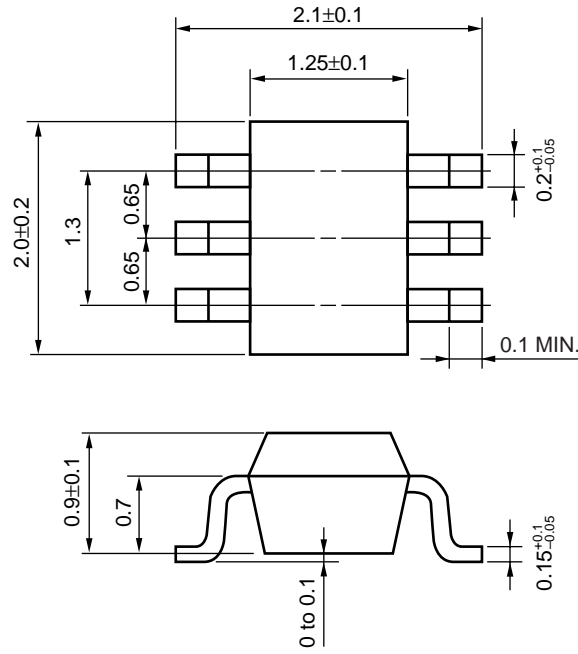

**9. NOTE ON CORRECT USE**

- (1) Observe precautions for handling because of electrostatic sensitive devices.
- (2) Form a ground pattern as wide as possible to minimize ground impedance (to prevent undesired oscillation).
- (3) Connect a bypass capacitor (example: 1 000 pF) to the V<sub>CC</sub> pin.
- (4) Connect a matching circuit to the RF output pin.
- (5) The DC cut capacitor must be each attached to the input and output pins.

**10. RECOMMENDED SOLDERING CONDITIONS**

This product should be soldered under the following recommended conditions. For soldering methods and conditions other than those recommended below, contact your NEC sales representative.

Soldering Method	Soldering Conditions	Recommended Condition Symbol
Infrared Reflow	Package peak temperature: 235°C or below Time: 30 seconds or less (at 210°C) Count: 3, Exposure limit: None <sup>Note</sup>	IR35-00-3
VPS	Package peak temperature: 215°C or below Time: 40 seconds or less (at 200°C) Count: 3, Exposure limit: None <sup>Note</sup>	VP15-00-3
Wave Soldering	Soldering bath temperature: 260°C or below Time: 10 seconds or less Count: 1, Exposure limit: None <sup>Note</sup>	WS60-00-1
Partial Heating	Pin temperature: 300°C Time: 3 seconds or less (per side of device) Exposure limit: None <sup>Note</sup>	—

**Note** After opening the dry pack, keep it in a place below 25°C and 65% RH for the allowable storage period.

**Caution** Do not use different soldering methods together (except for partial heating).

For details of recommended soldering conditions for surface mounting, refer to information document SEMICONDUCTOR DEVICE MOUNTING TECHNOLOGY MANUAL (C10535E).

[MEMO]

[MEMO]

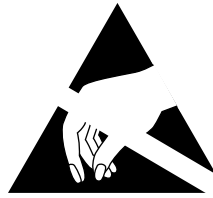

## ATTENTION

OBSERVE PRECAUTIONS  
FOR HANDLING  
ELECTROSTATIC  
SENSITIVE  
DEVICES

- **The information in this document is current as of September, 2000. The information is subject to change without notice. For actual design-in, refer to the latest publications of NEC's data sheets or data books, etc., for the most up-to-date specifications of NEC semiconductor products. Not all products and/or types are available in every country. Please check with an NEC sales representative for availability and additional information.**
  - No part of this document may be copied or reproduced in any form or by any means without prior written consent of NEC. NEC assumes no responsibility for any errors that may appear in this document.
  - NEC does not assume any liability for infringement of patents, copyrights or other intellectual property rights of third parties by or arising from the use of NEC semiconductor products listed in this document or any other liability arising from the use of such products. No license, express, implied or otherwise, is granted under any patents, copyrights or other intellectual property rights of NEC or others.
  - Descriptions of circuits, software and other related information in this document are provided for illustrative purposes in semiconductor product operation and application examples. The incorporation of these circuits, software and information in the design of customer's equipment shall be done under the full responsibility of customer. NEC assumes no responsibility for any losses incurred by customers or third parties arising from the use of these circuits, software and information.
  - While NEC endeavours to enhance the quality, reliability and safety of NEC semiconductor products, customers agree and acknowledge that the possibility of defects thereof cannot be eliminated entirely. To minimize risks of damage to property or injury (including death) to persons arising from defects in NEC semiconductor products, customers must incorporate sufficient safety measures in their design, such as redundancy, fire-containment, and anti-failure features.
  - NEC semiconductor products are classified into the following three quality grades:  
"Standard", "Special" and "Specific". The "Specific" quality grade applies only to semiconductor products developed based on a customer-designated "quality assurance program" for a specific application. The recommended applications of a semiconductor product depend on its quality grade, as indicated below. Customers must check the quality grade of each semiconductor product before using it in a particular application.
    - "Standard": Computers, office equipment, communications equipment, test and measurement equipment, audio and visual equipment, home electronic appliances, machine tools, personal electronic equipment and industrial robots
    - "Special": Transportation equipment (automobiles, trains, ships, etc.), traffic control systems, anti-disaster systems, anti-crime systems, safety equipment and medical equipment (not specifically designed for life support)
    - "Specific": Aircraft, aerospace equipment, submersible repeaters, nuclear reactor control systems, life support systems and medical equipment for life support, etc.
- The quality grade of NEC semiconductor products is "Standard" unless otherwise expressly specified in NEC's data sheets or data books, etc. If customers wish to use NEC semiconductor products in applications not intended by NEC, they must contact an NEC sales representative in advance to determine NEC's willingness to support a given application.

(Note)

- (1) "NEC" as used in this statement means NEC Corporation and also includes its majority-owned subsidiaries.
- (2) "NEC semiconductor products" means any semiconductor product developed or manufactured by or for NEC (as defined above).