

FEATURES

- Ultrahigh detectivity photodetector
- 90 fA/ $\sqrt{\text{Hz}}$ (typical) ultralow noise floor
- Signal-to-noise ratio (SNR) near shot noise limit
- 137 μA (typical) of supply current when active
($E_E = 0 \mu\text{W}/\text{cm}^2$)
- 1 μA (typical) of supply current in standby
- High speed, deep junction photodiode
- Nominal linear output current: 240 μA (typical)
- Flexible output configuration
- Excellent pulse response
- High ambient light rejection
- Space-saving, 3 mm \times 4 mm LFCSP package

APPLICATIONS

- Heart rate, pulse oximetry monitoring
(photoplethysmography)
- Battery-powered medical sensors
- Chemical analysis

GENERAL DESCRIPTION

The [ADPD2212](#) is an optical sensor optimized for biomedical applications. Very low power consumption and near theoretical signal-to-noise ratio (SNR) are achieved by packaging an ultralow capacitance deep junction silicon photodiode operated in zero bias photoconductive mode with a low noise current amplifier. The [ADPD2212](#) offers a typical 400 kHz bandwidth performance, which is well suited for use with pulsed excitation. The [ADPD2212](#) uses very little power during operation and incorporates a power-down pin, enabling power cycling to optimize battery

FUNCTIONAL BLOCK DIAGRAM

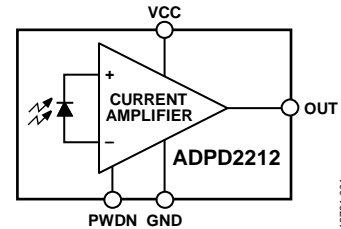

Figure 1.

life in portable applications. The [ADPD2212](#) provides shot noise limited performance, making it an excellent choice for measuring signals with the highest possible fidelity in low light conditions. This combination of low power, very high SNR, and electromagnetic interference (EMI) immunity enables low power system solutions not possible with traditional photodiode (PD) and transimpedance amplifier (TIA) systems.

TABLE OF CONTENTS

Features	1	Shot Noise Limited Performance	9
Applications.....	1	Sensitivity and SNR.....	9
Functional Block Diagram	1	Linearity.....	9
General Description	1	Package Considerations.....	9
Revision History	2	EPAD Connection.....	9
Specifications.....	3	Applications Information	10
Absolute Maximum Ratings.....	4	Powering the Device	10
Thermal Resistance	4	Power-Down Mode.....	10
Soldering Profile	4	Pulse Mode Operation.....	10
ESD Caution.....	4	Output Configuration.....	10
Pin Configuration and Function Descriptions.....	5	3-Wire Cable Voltage Configuration.....	10
Typical Performance Characteristics	6	3-Wire Current Mode Configuration.....	10
Terminology	8	Evaluation Board Schematic and Layout	12
Theory of Operation	9	Outline Dimensions	13
Overview.....	9	Ordering Guide	13

REVISION HISTORY

4/16—Revision 0: Initial Version

SPECIFICATIONS

$V_{CC} = 3.3\text{ V}$, $T_A = 25^\circ\text{C}$, $\lambda = 528\text{ nm}$, unless otherwise noted. I_{PD} is the photodiode current, I_{MOD} is the modulation current, E_E is irradiance, I_{OUT} is output current, V_{BIAS} is the bias voltage, $R_{FEEDBACK}$ is the TIA feedback resistor, and R_{LOAD} is the load resistance.

Table 1.

Parameter	Symbol	Test Conditions/Comments	Min	Typ	Max	Unit
GAIN						
Gain (Current Amplifier)	β_{TLA}			24		
DYNAMIC PERFORMANCE						
Frequency Response Peaking				<6		dB
Rise Time	t_R	10% to 90% full scale (FS) ($I_{OUT} = 24\ \mu\text{A}$)		1.24		μs
Fall Time	t_F	90% to 10% FS ($I_{OUT} = 24\ \mu\text{A}$)		1.27		μs
Bandwidth	BW	$I_{PD} = 10\ \text{nA}$, $I_{MOD} = 1\ \text{nA}$		400		kHz
OPTICAL PERFORMANCE						
Diode Active Area				2.5		mm^2
Saturation Irradiance				1600		$\mu\text{W}/\text{cm}^2$
NOISE PERFORMANCE						
Current Noise, Output Referred ¹		$E_E = 0\ \mu\text{W}/\text{cm}^2$		1920		$\text{fA}/\sqrt{\text{Hz}}$
		$I_{PD} = 10\ \text{nA}$ to $300\ \text{nA}$		$1.4 \times N_{\text{SHOT}}$		$\text{fA}/\sqrt{\text{Hz}}$
		$I_{PD} > 300\ \text{nA}$		$1.15 \times N_{\text{SHOT}}$		$\text{fA}/\sqrt{\text{Hz}}$
Current Noise Floor, Input Referred		$E_E = 0\ \mu\text{W}/\text{cm}^2$, at 1 kHz		90	150	$\text{fA}/\sqrt{\text{Hz}}$
Noise Equivalent Power	NEP	At 1 kHz		100		$\text{fW}/\sqrt{\text{Hz}}$
E_E Required for SNR = 10000:1		At 1 kHz		144		nW/cm^2
POWER AND SUPPLY						
Supply Voltage	V_{CC}		1.8	3.3	5.0	V
Power Supply Rejection Ratio	PSRR	$V_{CC} = 1.8\ \text{V}$ to $5.0\ \text{V}$, $E_E = 1600\ \mu\text{W}/\text{cm}^2$		120		nA/V
Current						
Standby	I_{STANDBY}	PWDN > V_{IH}		1		μA
Supply at $E_E = 0\ \mu\text{W}/\text{cm}^2$	I_{FLOOR}			137		μA
Supply ²	I_{SUPPLY}	$I_{OUT} = 10\ \mu\text{A}$		166		μA
		$I_{OUT} = 240\ \mu\text{A}$		857		μA
OUTPUT CHARACTERISTICS						
Amplifier Static Bias Current						
Input Referred		$E_E = 0\ \mu\text{W}/\text{cm}^2$		10		nA
Output Referred		$E_E = 0\ \mu\text{W}/\text{cm}^2$		240		nA
Maximum Output Voltage	$V_{\text{OUT_MAX}}$			$V_{CC} - 0.75$		V
Nominal Linear Output Current	$I_{\text{OUT_FS}}$			240		μA
Linearity into TIA		$V_{\text{BIAS}} = 1.3\ \text{V}$, $R_{\text{FEEDBACK}} = 25\ \text{k}\Omega$		60		dB
Linearity into Resistive Load		$I_{OUT} < 100\ \mu\text{A}$, $R_{\text{LOAD}} = 5\ \text{k}\Omega$		60		dB
Peak Output Current ³				300		μA
Output Capacitance	C_{OUT}	From OUT to GND		5		pF
Output Resistance	R_{OUT}	From OUT to GND		1000		M Ω
POWER-DOWN LOGIC						
Input Voltage						
High Level	V_{IH}		$V_{CC} - 0.2$			V
Low Level	V_{IL}				0.2	V
Leakage Current						
High	I_{IH}	PWDN = 3.3 V		0.2		nA
Low	I_{IL}	PWDN = 0 V		-8.5		μA
OPERATING AMBIENT TEMPERATURE RANGE						
			-40		+85	$^\circ\text{C}$

¹ N_{SHOT} refers to photon shot noise. Photon shot noise is the fundamental noise floor for all photodetectors in photoconductive mode.

² $I_{\text{SUPPLY}} = I_{\text{FLOOR}} + (3 \times I_{\text{OUT}})$.

³ Outputs greater than $I_{\text{OUT_FS}}$ may have degraded performance.

ABSOLUTE MAXIMUM RATINGS

Table 2.

Parameter	Rating
Supply Voltage (VCC)	6.0 V
Storage Temperature Range	-40°C to +105°C
Junction Temperature	110°C
Solder Reflow Temperature (<10 sec)	260°C

Stresses at or above those listed under Absolute Maximum Ratings may cause permanent damage to the product. This is a stress rating only; functional operation of the product at these or any other conditions above those indicated in the operational section of this specification is not implied. Operation beyond the maximum operating conditions for extended periods may affect product reliability.

THERMAL RESISTANCE

θ_{JA} is specified for the worst case conditions, that is, a device soldered in a circuit board for surface-mount packages.

Table 3. Thermal Resistance

Package Type	θ_{JA}	θ_{JC}	Unit
3 mm × 4 mm LFCSP	66.62	11.46	°C/W

SOLDERING PROFILE

Figure 2 and Table 4 provide information about the recommended soldering profile.

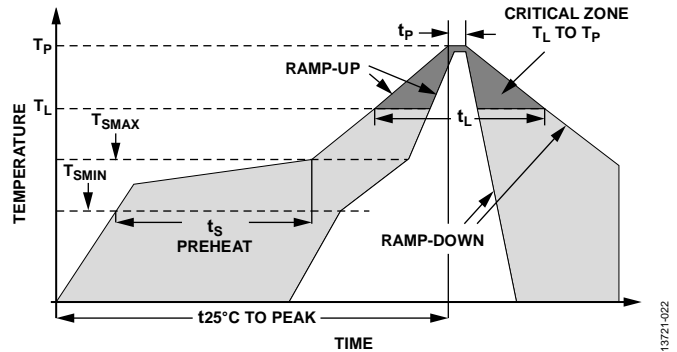

Figure 2. Recommended Soldering Profile

Table 4. Recommended Soldering Profile Limits¹

Profile Feature	Condition (Pb Free)
Average Ramp Rate (T_L to T_P)	2°C/sec maximum
Preheat	
Minimum Temperature (T_{SMIN})	150°C
Maximum Temperature (T_{SMAX})	200°C
Time from T_{SMIN} to T_{SMAX} (t_S)	60 sec to 120 sec
Ramp-Up Rate (T_{SMAX} to T_L)	2°C/sec maximum
Liquidus Temperature (T_L)	217°C
Time Maintained Above T_L (t_L)	60 sec to 150 sec
Peak Temperature (T_P)	260°C + (0°C/-5°C)
Time Within 5°C of Actual T_P (t_p)	20 sec to 30 sec
Ramp-Down Rate	3°C/sec maximum
Time from 25°C ($t_{25°C}$) to Peak Temperature	8 minutes maximum

¹ Based on JEDEC Standard J-STD-020D.1.

ESD CAUTION



ESD (electrostatic discharge) sensitive device. Charged devices and circuit boards can discharge without detection. Although this product features patented or proprietary protection circuitry, damage may occur on devices subjected to high energy ESD. Therefore, proper ESD precautions should be taken to avoid performance degradation or loss of functionality.

PIN CONFIGURATION AND FUNCTION DESCRIPTIONS

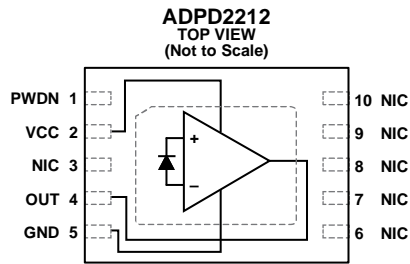
NOTES

1. NIC = NOT INTERNALLY CONNECTED.
2. THE EXPOSED PAD MUST BE LEFT FLOATING. THE PCB AREA UNDER THE EXPOSED PAD CAN BE LEFT BLANK TO FACILITATE THIS REQUIREMENT.

13721-003

Figure 3. Pin Configuration

Table 5. Pin Function Descriptions

Pin No.	Mnemonic	Description
1	PWDN	Power-Down Input. Must be connected. Pull this pin high to disable the device.
2	VCC	Supply Voltage.
3	NIC	Not Internally Connected. This pin can be grounded.
4	OUT	Output Terminal.
5	GND	Ground.
6	NIC	Not Internally Connected. This pin can be grounded.
7	NIC	Not Internally Connected. This pin can be grounded.
8	NIC	Not Internally Connected. This pin can be grounded.
9	NIC	Not Internally Connected. This pin can be grounded.
10	NIC	Not Internally Connected. This pin can be grounded.
11	EPAD	Exposed Pad. The exposed pad must be left floating. The printed circuit board (PCB) area under the exposed pad can be left blank to facilitate this requirement.

TYPICAL PERFORMANCE CHARACTERISTICS

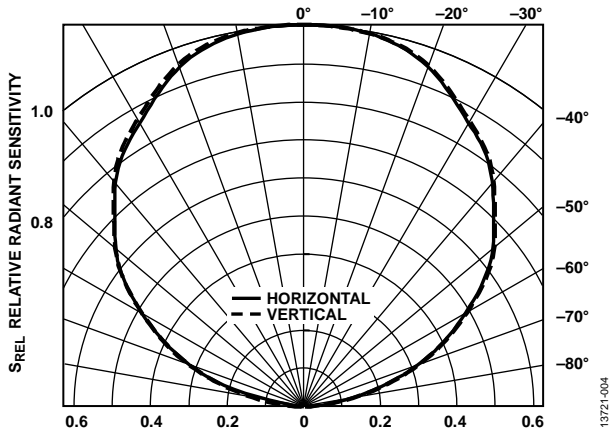

Figure 4. Relative Radiant Sensitivity vs. Angular Displacement

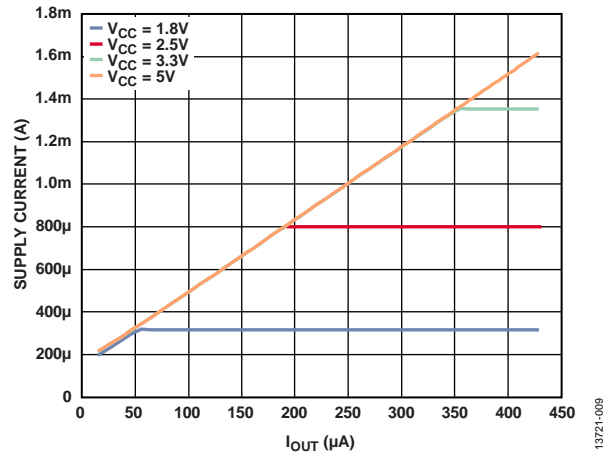

Figure 7. Supply Current vs. Output Current (I_{OUT}) over Supply Voltage (V_{CC})

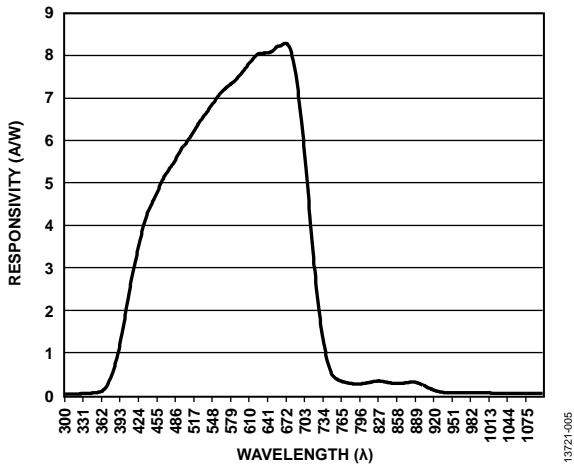

Figure 5. Responsivity vs. Wavelength

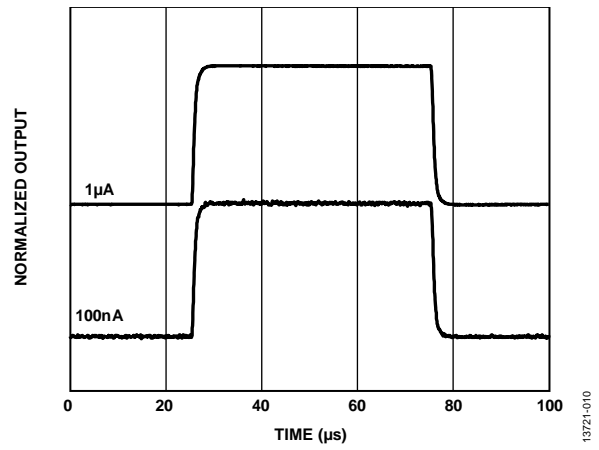

Figure 8. Small Signal Pulse Response

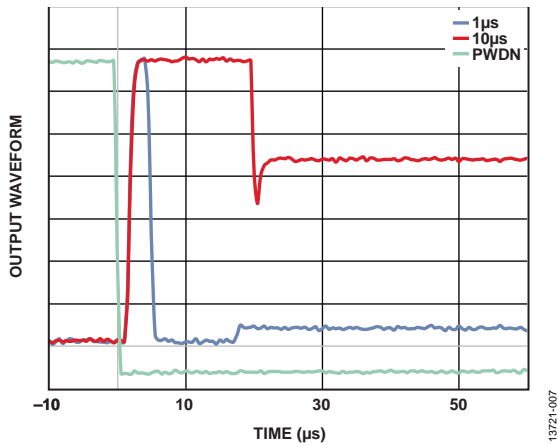

Figure 6. Power-Down Recovery Time, 1%

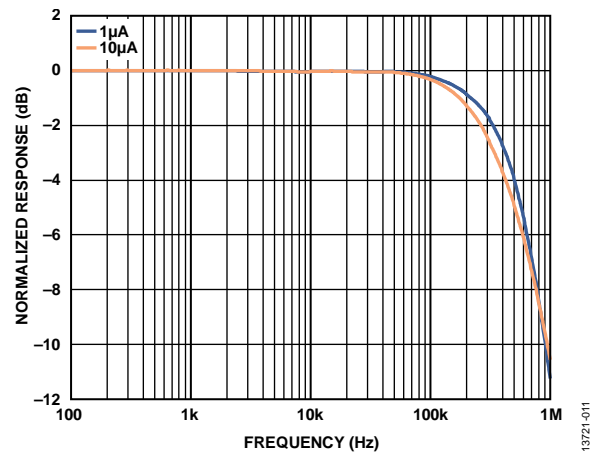

Figure 9. Bandwidth/Peaking

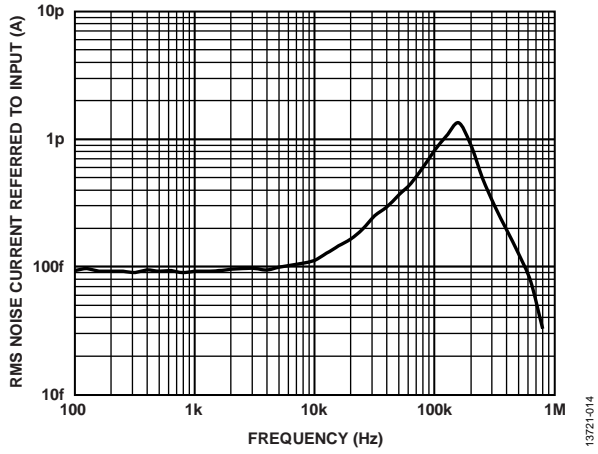

Figure 10. Noise Bandwidth/Peaking

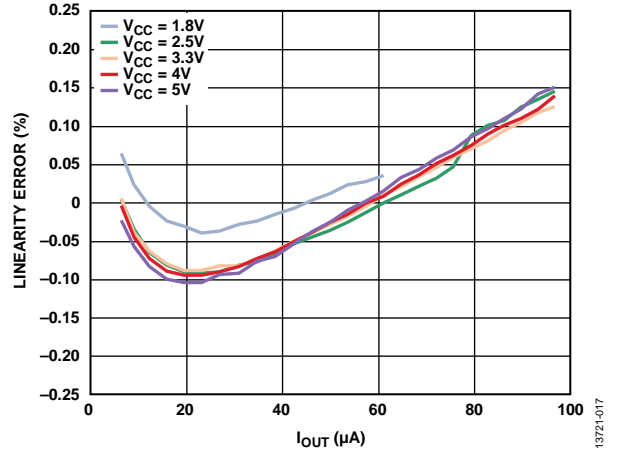

Figure 12. Linearity Error vs. Output Current (I_{OUT}) over Supply Voltage (V_{CC})

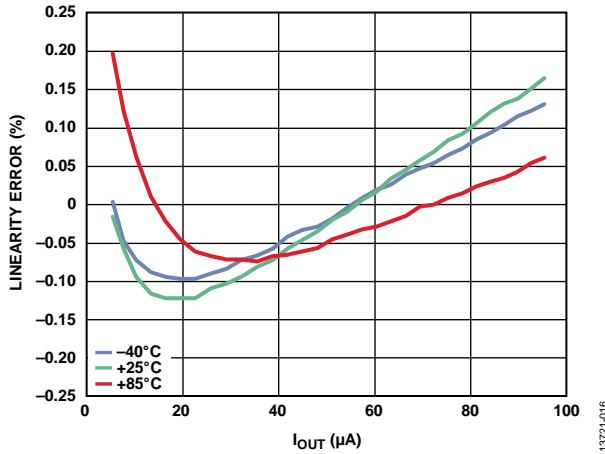

Figure 11. Linearity Error vs. Output Current (I_{OUT}) over Temperature

TERMINOLOGY

Optical Power

Optical power is defined as the photon energy per unit of time measured as radiant flux (Φ) or radiant power, which is radiant energy (Q) per unit of time.

Responsivity

Photodiode responsivity, ρ , is a constant that correlates incident optical power (P_{OPT}) with photodiode current (I_{PD}) and is typically expressed in units of amperes per watt (A/W). Responsivity is essentially the quantum efficiency of the ability of the sensor to convert light into electron/hole pairs and is highly dependent upon the wavelength of the incident light as well as sensor material and temperature.

Photodiode Area

Photodiode area is a measure of the photosensitive area of the diode. In PIN diodes, this is the photosensitive area of intrinsic silicon between the positive and negative doped diffusion areas. In general, larger photodiodes demonstrate greater sensitivity as the output signal increases linearly with photosensitive area while noise increases at the sum of the square of the photosensitive area. A larger photodiode area has a higher capacitance and longer carrier diffusion paths adversely affecting bandwidth.

Photoconductive Mode

Photoconductive operation of a photodiode occurs when photons entering the silicon generate electron/hole pairs that are swept by the electric field to the opposite terminal. These carriers are presented at the terminals of the photodiode as a current proportional to the luminous flux incident on the junction of the photodiode.

Shot Noise

Shot noise is a statistical fluctuation in any quantized signal such as photons of light and electrons in current. The magnitude of the shot noise is expressed as a root mean square (rms) noise

current. Shot noise is a fundamental limitation in photodetectors and takes the form of

$$\text{Shot noise} = \sqrt{(2qI_{PD})}$$

where:

q is the charge of an electron (1.602×10^{-19} Coulomb).

I_{PD} is the photodiode current.

Photoplethysmography (PPG)

Photoplethysmography uses light to measure biological functions by sensing changes in the absorption spectra of soft tissue due to changes in hemoglobin volume and composition.

Linearity

Linearity is a measure of the deviation from an ideal change in output current relative to a change in optical power falling on the sensor. Linearity is specified as the deviation from a best straight line fit of the current output of the sensor over a specified range of optical power. Linearity is a critical specification in PPG measurements due to the requirement of sensing small ac signals impressed upon large dc offsets.

Static Bias

The [ADPD2212](#) has an internal 10 nA bias that linearizes the input current mirror at low input levels and prevents transient reverse bias of the amplifier input stage. This bias is fixed and appears on the output as a 240 nA typical offset.

Noise Equivalent Power (NEP)

Noise equivalent power is the amount of incident light power on a photodetector, which generates a photocurrent equal to the total noise current of the sensor. The noise level is proportional to the square root of the frequency bandwidth; therefore, NEP is specified with a 1 Hz bandwidth. NEP is the fundamental baseline of the detectivity of the sensor.

THEORY OF OPERATION

OVERVIEW

The [ADPD2212](#) is an integrated, low power, optical sensor composed of a deep junction silicon photodiode coupled to a low noise current amplifier in an optically transparent chip scale package. The [ADPD2212](#) is optimized for battery-powered, wearable, medical, and industrial optical sensing applications requiring low power and high SNR.

SHOT NOISE LIMITED PERFORMANCE

The on-board photodiode of the [ADPD2212](#) is operated in photoconductive mode with a zero bias voltage. This mode of operation allows the diode to operate with no dc dark current caused by leakage across the depletion area of the diode, providing a fundamental limit of shot noise. The noise level is proportional to the square root of the frequency bandwidth.

SENSITIVITY AND SNR

SNR is a measure of the ability of the sensor to separate the signal of interest from spurious signals that occur from the surrounding environment of the device, such as ambient light, nonlinearity, and noise within the device itself.

The [ADPD2212](#) operates its integrated photodiode in a zero biased photoconductive mode to provide near zero dark current and, therefore, no dark shot noise component contribution from the photodiode. The integrated current amplifier requires an internal bias current of 10 nA to improve bandwidth and linearize response at low light levels. This bias generates a shot noise component of $90 \text{ fA}/\sqrt{\text{Hz}}$ at the output of the current amplifier and establishes the noise floor of the [ADPD2212](#).

To optimize the sensitivity of the [ADPD2212](#), it is important to ensure that the optical signal is concentrated on the photoactive area of the integrated photodiode. The on-board precision current amplifier is shielded and is not significantly affected by light hitting its surface, but device sensitivity is based solely on the optical power incident to the photodetector.

LINEARITY

Linearity is critical to PPG due to the need to accurately extract a small amplitude, pulsatile ac signal modulated onto the large dc component, which is caused by nonpulsatile tissue absorption and ambient light. In pulsed light applications, bandwidth is a critical component of the linearity because fast recovery of the device from dark and/or power-down conditions can have a profound effect on the ability of the sensor to extract the signal of interest. The [ADPD2212](#) is production trimmed to ensure 60 dB linearity at an irradiance of up to $E_e = 1600 \text{ } \mu\text{W}/\text{cm}^2$, $\lambda = 528 \text{ nm}$, at a supply voltage of 3.3 V.

PACKAGE CONSIDERATIONS

The [ADPD2212](#) is packaged with a transparent epoxy molding compound. To maintain optimum sensitivity, take care in handling the device to prevent scratches or chemicals that may affect the surface finish above the photodiode. Due to the lack of stabilizing fillers (typically up to 70% silica) used in opaque molding compounds, the maximum storage temperature of the [ADPD2212](#) is 105°C. The temperature profile for soldering is shown in Figure 2.

EPAD CONNECTION

The EPAD on the [ADPD2212](#) acts as a common electrical, thermal, and mechanical platform for the photodiode and amplifier and must not be connected externally. External cooling is not required due to the extremely low power consumption of the [ADPD2212](#). Analog Devices, Inc., recommends removal of traces beneath the device to eliminate potential coupling of external signals into the sensitive internal nodes of the [ADPD2212](#).

APPLICATIONS INFORMATION

The current output of the [ADPD2212](#) provides flexibility in interfacing to external circuitry.

POWERING THE DEVICE

The [ADPD2212](#) is powered from a single positive 1.8 V to 5.0 V supply. The [ADPD2212](#) features high PSRR, but proper circuit layout and bypassing is recommended to provide maximum sensitivity, especially in situations where the [ADPD2212](#) may share reference nodes with transmitters in pulse mode applications. Above the quiescent current of the integrated current amplifier, there is a linear relationship to incident light as the current amplifier amplifies the photodiode output by a factor of 24. In typical battery-powered operation, the output of the source LEDs is dynamically reduced to save power based on the received signal strength of the photosensor. The extremely low noise floor of the [ADPD2212](#) provides very high SNR, allowing accurate signal extraction with minimal source power and at low incident optical power.

POWER-DOWN MODE

The [ADPD2212](#) is optimized for battery-powered operation by the inclusion of an extremely low power standby mode that can be quickly switched to provide ultralow power consumption during dark periods in pulsed or mode locked applications, where the light source is cycled to improve ambient light rejection and reduce transmitter power consumption. The power-down pin is not internally pulled up or down, and must be connected to an external logic level for proper operation of the [ADPD2212](#).

PULSE MODE OPERATION

The [ADPD2212](#) is optimized for battery-powered operation by the inclusion of a power-down pin (PWDN). When sensing is inactive, the [ADPD2212](#) can be quickly switched into standby mode, reducing the supply current to 1 μ A during dark periods for pulsed or mode locked applications, where the light source is cycled to improve ambient light rejection and reduce transmitter power consumption.

For multiple wavelength systems, sequentially pulsing the optical emitters removes the need for multiple narrow bandwidth sensors. For both multiple wavelength (SpO₂) and single wavelength (heart rate monitoring) systems, pulsed operation can provide significant power savings for battery-powered systems. Pulsed mode operation provides a calibration signal that is necessary to compensate for ambient light diffused throughout the tissue, which can be extracted by measuring the sensor output while the system emitters are off. Advanced algorithms can then extract the signal of interest from dc offsets, noise, and interferer signals such as motion artifacts.

OUTPUT CONFIGURATION

The output of the [ADPD2212](#) allows different configurations depending on the application. The current gain of the [ADPD2212](#) reduces the effect of surrounding interferers but, for best performance, careful design and layout is still necessary to achieve the best performance. The effect of capacitance on the output must be considered carefully regardless of configuration as bandwidth and response time of the system can be limited simply by the time required to charge and discharge parasitics.

Because the [ADPD2212](#) is effectively a current source, the [ADPD2212](#) output voltage drifts up to its compliance voltage, approximately 1.2 V below V_{CC} , when connected to an interface that presents a high impedance. The rate of this drift is dependent on the [ADPD2212](#) output current, parasitic capacitance, and the impedance of the load. This drift can require additional settling time in circuits following the [ADPD2212](#) if they are actively multiplexing the output of the [ADPD2212](#) or presenting a high impedance due to power cycling. For multiplexed systems, a current steering architecture may offer a performance advantage over a break-before-make switch matrix.

3-WIRE CABLE VOLTAGE CONFIGURATION

The [ADPD2212](#) can be used in a minimal 3-wire voltage configuration, offering a compact solution with very few components (see Figure 13). A shunt resistor (R_s) sets the transimpedance gain in front of the analog-to-digital converter (ADC). This configuration allows flexibility in matching the ADC converter full-scale input to the full-scale output of the [ADPD2212](#). The dynamic range of the interface is limited to the compliance voltage of the [ADPD2212](#).

No additional amplification is needed prior to the ADC. Response time at the lower end of the range is limited by the ability of the output current to charge the parasitic capacitance presented to the output of the [ADPD2212](#).

3-WIRE CURRENT MODE CONFIGURATION

When used in the 3-wire current mode configuration with a photodiode (see Figure 14), the [ADPD2212](#) is insensitive to load resistance and can be used when the signal processing is further from the sensor. EMI noise and shielding requirements are minimized; however, cable capacitance has a direct effect on bandwidth, making the 3-wire current mode configuration a better choice for unshielded interfaces. The feedback capacitance (C_F) value must be chosen carefully to eliminate stability and bandwidth degradation of the [ADPD2212](#). Large capacitance around the feedback loop of the TIA has a direct effect on the bandwidth of the system.

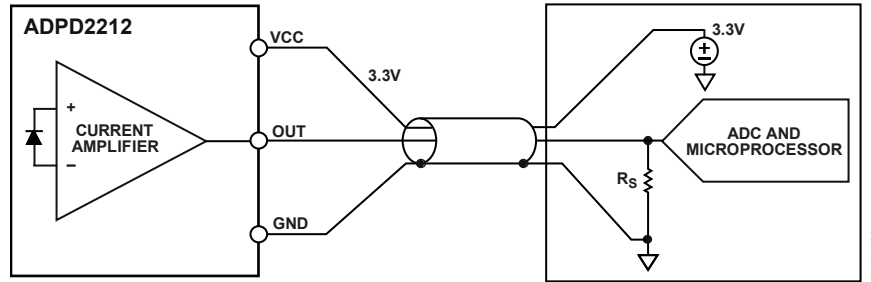

Figure 13. ADPD2212 Used in 3-Wire Cable Voltage Configuration

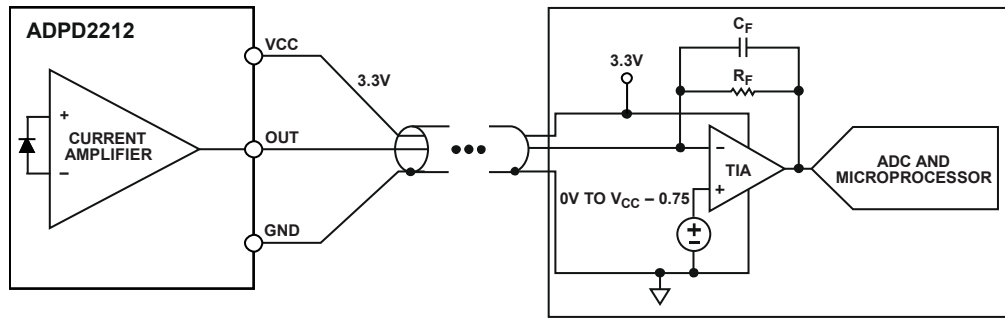

Figure 14. ADPD2212 Used in 3-Wire Current Mode Configuration

EVALUATION BOARD SCHEMATIC AND LAYOUT

Figure 17 shows the evaluation board schematic. Figure 15 and Figure 16 show the evaluation board layout for the top and bottom layers, respectively.

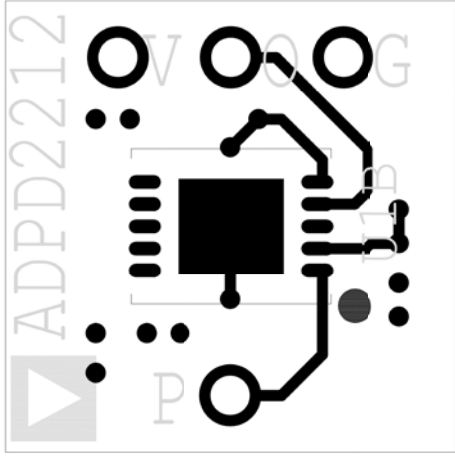

Figure 15. ADPD2212 Evaluation Board Top Layer

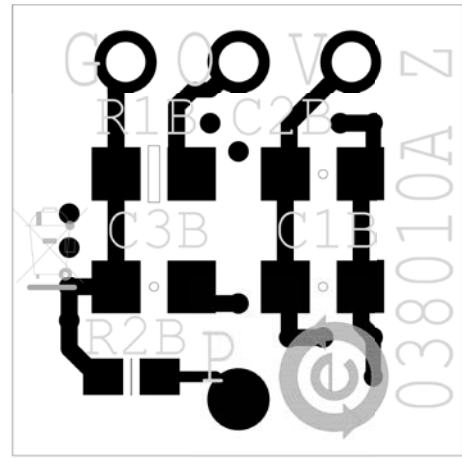

Figure 16. ADPD2212 Evaluation Board Bottom Layer

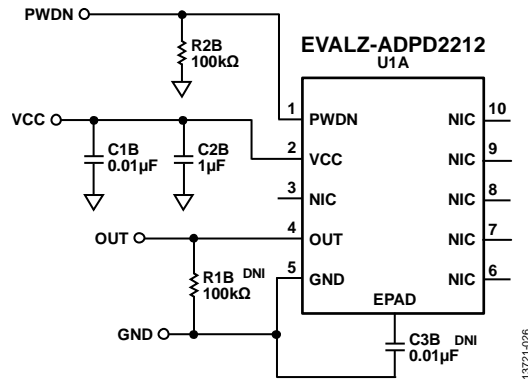

Figure 17. ADPD2212 Evaluation Board Schematic (Do Not Install C3B)

OUTLINE DIMENSIONS

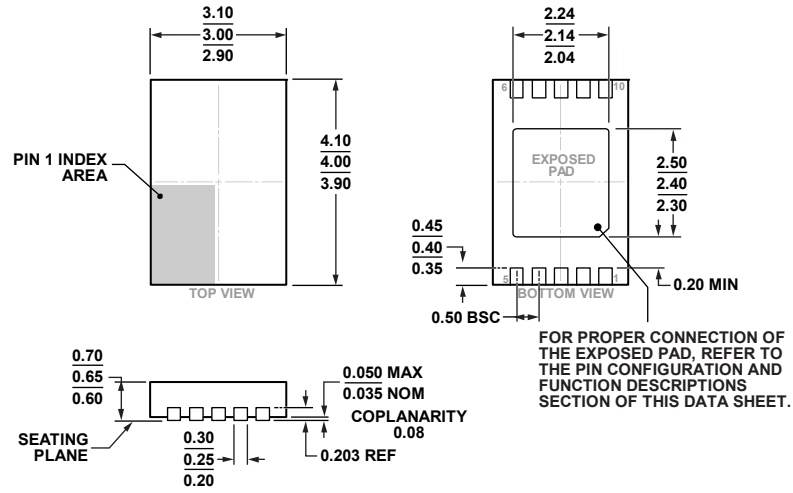

Figure 18. 10-Lead Lead Frame Chip Scale Package [LFCSP]
 3 mm × 4 mm Body and 0.65 mm Package Height
 (CP-10-33)
 Dimensions shown in millimeters

ORDERING GUIDE

Model ¹	Temperature Range	Package Description	Package Option	Ordering Quantity
ADPD2212ACPZ-R7	-40°C to +85°C	10-Lead Lead Frame Chip Scale Package [LFCSP]	CP-10-13	1500
ADPD2212ACPZ-RL	-40°C to +85°C	10-Lead Lead Frame Chip Scale Package [LFCSP]	CP-10-13	5000
EVALZ-ADPD2212		Evaluation Board		

¹ Z = RoHS Compliant Part.