

NSTB1005DXV5T1, NSTB1005DXV5T5

Preferred Devices

Dual Common Base-Collector Bias Resistor Transistors

NPN and PNP Silicon Surface Mount Transistors with Monolithic Bias Resistor Network

The BRT (Bias Resistor Transistor) contains a single transistor with a monolithic bias network consisting of two resistors; a series base resistor and a base-emitter resistor. These digital transistors are designed to replace a single device and its external resistor bias network. The BRT eliminates these individual components by integrating them into a single device. The NSTB1005DXV5T1 contains two complementary BRT devices are housed in the SOT-553 package which is ideal for low power surface mount applications where board space is at a premium.

- Simplifies Circuit Design
- Reduces Board Space
- Reduces Component Count
- Available in 8 mm, 7 inch Tape and Reel
- Lead Free

MAXIMUM RATINGS ($T_A = 25^\circ\text{C}$ unless otherwise noted, common for Q_1 and Q_2 , - minus sign for Q_1 (PNP) omitted)

Rating	Symbol	Value	Unit
Collector-Base Voltage	V_{CBO}	50	Vdc
Collector-Emitter Voltage	V_{CEO}	50	Vdc
Collector Current	I_C	100	mAdc

THERMAL CHARACTERISTICS

Characteristic (One Junction Heated)	Symbol	Max	Unit
Total Device Dissipation $T_A = 25^\circ\text{C}$ Derate above 25°C	P_D	357 (Note 1) 2.9 (Note 1)	mW mW/ $^\circ\text{C}$
Thermal Resistance – Junction-to-Ambient	$R_{\theta JA}$	350 (Note 1)	$^\circ\text{C}/\text{W}$
Characteristic (Both Junctions Heated)	Symbol	Max	Unit
Total Device Dissipation $T_A = 25^\circ\text{C}$ Derate above 25°C	P_D	500 (Note 1) 4.0 (Note 1)	mW mW/ $^\circ\text{C}$
Thermal Resistance – Junction-to-Ambient	$R_{\theta JA}$	250 (Note 1)	$^\circ\text{C}/\text{W}$
Junction and Storage Temperature	T_J, T_{stg}	-55 to +150	$^\circ\text{C}$

1. FR-4 @ Minimum Pad



ON Semiconductor®

<http://onsemi.com>

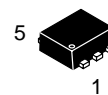
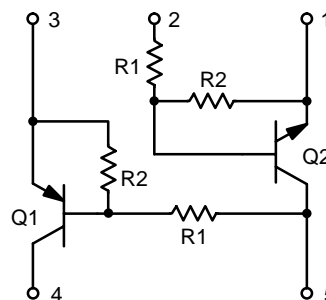

SOT-553
CASE 463B

MARKING DIAGRAM

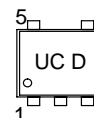

UC = Specific Device Code
D = Date Code

ORDERING INFORMATION

Device	Package	Shipping†
NSTB1005DXV5T1	SOT-553	4 mm pitch 4000/Tape & Reel
NSTB1005DXV5T5	SOT-553	2 mm pitch 8000/Tape & Reel

†For information on tape and reel specifications, including part orientation and tape sizes, please refer to our Tape and Reel Packaging Specification Brochure, BRD8011/D.

Preferred devices are recommended choices for future use and best overall value.

NSTB1005DXV5T1, NSTB1005DXV5T5

ELECTRICAL CHARACTERISTICS (T_A = 25°C unless otherwise noted)

Characteristic	Symbol	Min	Typ	Max	Unit
Q1 TRANSISTOR: PNP – OFF CHARACTERISTICS					
Collector–Base Cutoff Current (V _{CB} = 50 V, I _E = 0)	I _{CBO}	–	–	100	nAdc
Collector–Emitter Cutoff Current (V _{CE} = 50 V, I _B = 0)	I _{CEO}	–	–	500	nAdc
Emitter–Base Cutoff Current	I _{EBO}	–	–	0.1	mAdc
Collector–Base Breakdown Voltage (I _C = 10 μA, I _E = 0)	V _{(BR)CBO}	50	–	–	Vdc
Collector–Emitter Breakdown Voltage (I _C = 2.0 mA, I _B = 0)	V _{(BR)CEO}	50	–	–	Vdc

ON CHARACTERISTICS

DC Current Gain	h _{FE}	80	140	–	
Collector–Emitter Saturation Voltage (I _C = 10 mA, I _E = 0.3 mA)	V _{CE(sat)}	–	–	0.25	Vdc
Output Voltage (on) (V _{CC} = 5.0 V, V _B = 3.5 V, R _L = 1.0 kΩ)	V _{OL}	–	–	0.2	Vdc
Output Voltage (off) (V _{CC} = 5.0 V, V _B = 0.5 V, R _L = 1.0 kΩ)	V _{OH}	4.9	–	–	Vdc
Input Resistor	R1	32.9	47	61.1	kΩ
Resistor Ratio	R ₁ /R ₂	0.8	1.0	1.2	

Q2 TRANSISTOR: NPN – OFF CHARACTERISTICS

Collector–Base Cutoff Current (V _{CB} = 50 V, I _E = 0)	I _{CBO}	–	–	100	nAdc
Collector–Emitter Cutoff Current (V _{CB} = 50 V, I _B = 0)	I _{CEO}	–	–	500	nAdc
Emitter–Base Cutoff Current (V _{EB} = 6.0, I _C = 5.0 mA)	I _{EBO}	–	–	0.1	mAdc

ON CHARACTERISTICS

Collector–Base Breakdown Voltage (I _C = 10 μA, I _E = 0)	V _{(BR)CBO}	50	–	–	Vdc
Collector–Emitter Breakdown Voltage (I _C = 2.0 mA, I _B = 0)	V _{(BR)CEO}	50	–	–	Vdc
DC Current Gain (V _{CE} = 10 V, I _C = 5.0 mA)	h _{FE}	80	140	–	
Collector–Emitter Saturation Voltage (I _C = 10 mA, I _B = 0.3 mA)	V _{CE(SAT)}	–	–	0.25	Vdc
Output Voltage (on) (V _{CC} = 5.0 V, V _B = 2.5 V, R _L = 1.0 kΩ)	V _{OL}	–	–	0.2	Vdc
Output Voltage (off) (V _{CC} = 5.0 V, V _B = 0.5 V, R _L = 1.0 kΩ)	V _{OH}	4.9	–	–	Vdc
Input Resistor	R1	33	47	61	kΩ
Resistor Ratio	R1/R2	0.8	1.0	1.2	

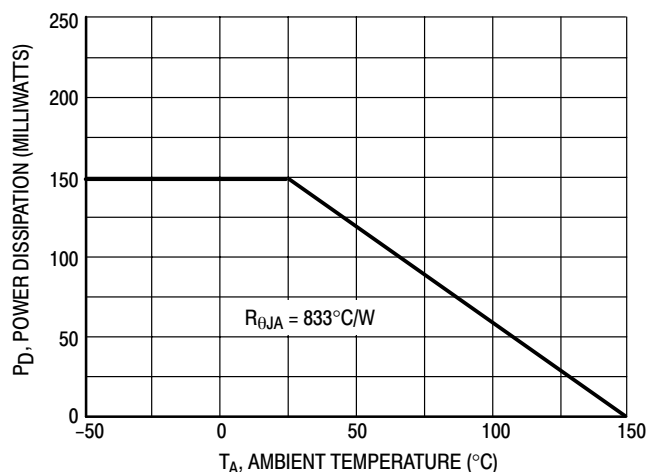

Figure 1. Derating Curve

NSTB1005DXV5T1, NSTB1005DXV5T5

TYPICAL ELECTRICAL CHARACTERISTICS – PNP TRANSISTOR

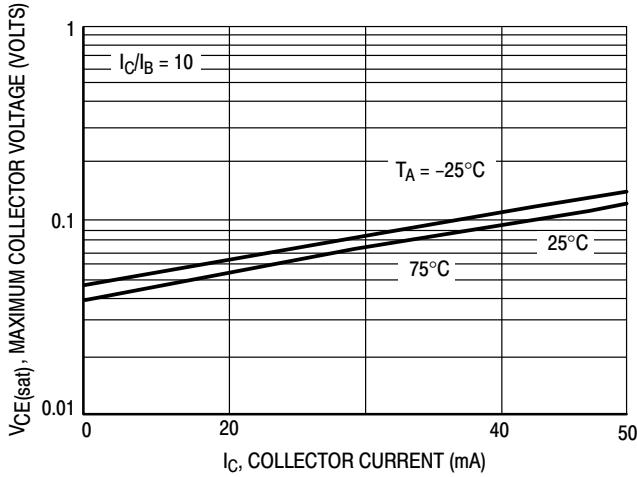

Figure 2. $V_{CE(sat)}$ versus I_C

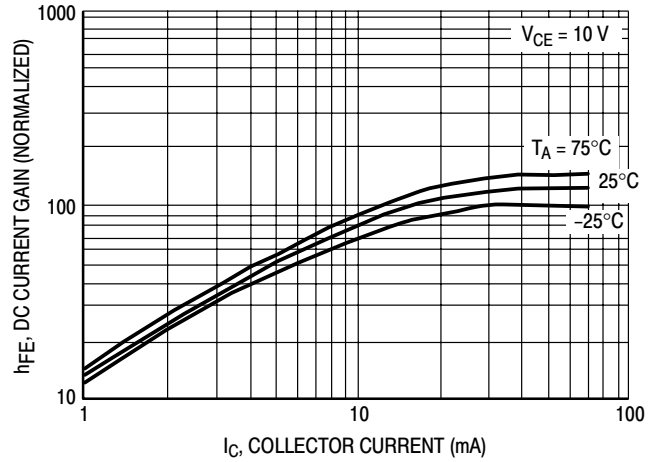

Figure 3. DC Current Gain

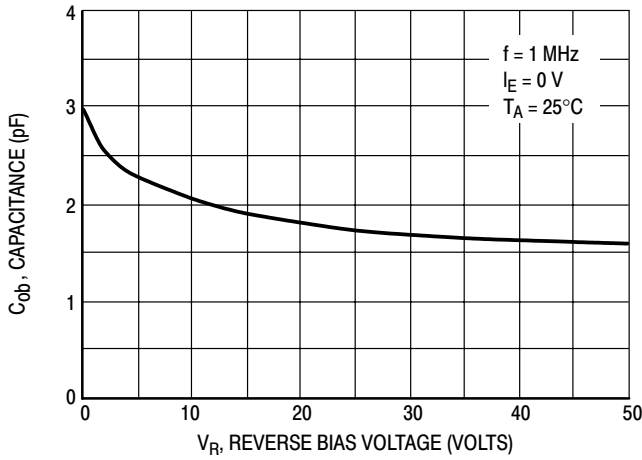

Figure 4. Output Capacitance

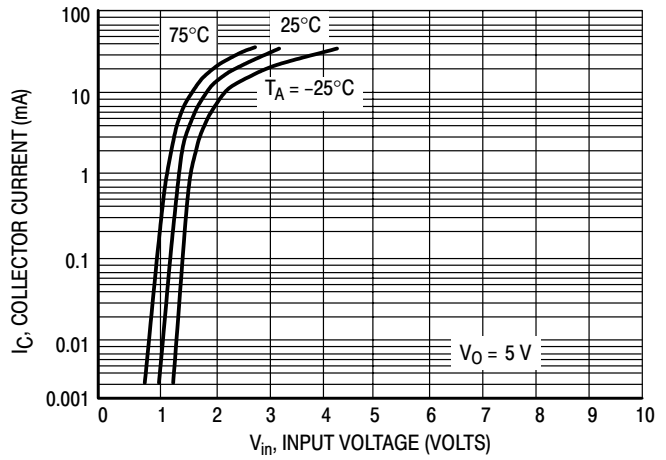

Figure 5. Output Current versus Input Voltage

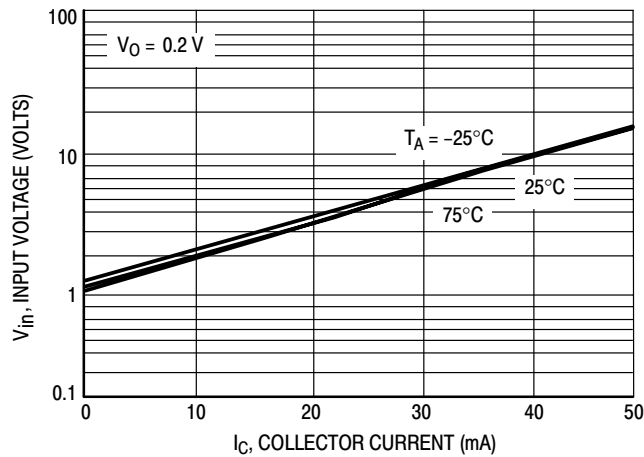

Figure 6. Input Voltage versus Output Current

NSTB1005DXV5T1, NSTB1005DXV5T5

TYPICAL ELECTRICAL CHARACTERISTICS — NPN TRANSISTOR

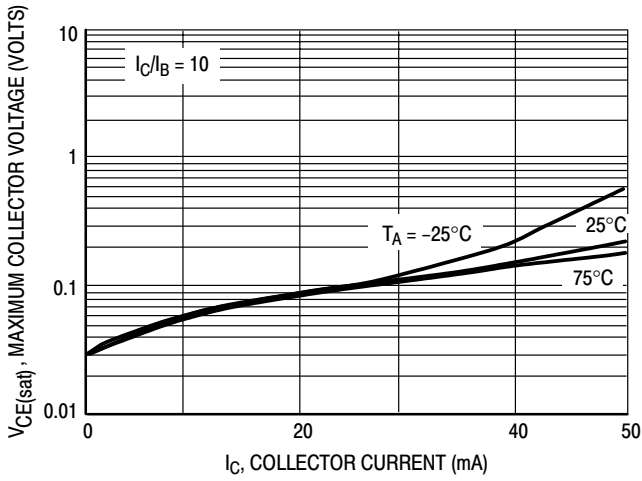

Figure 7. $V_{CE(sat)}$ versus I_C

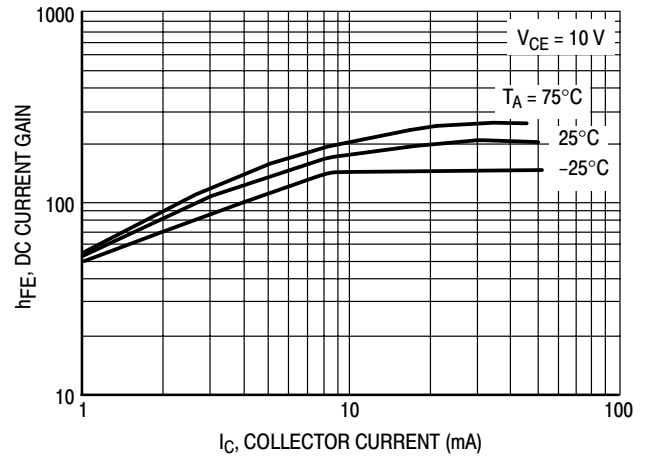

Figure 8. DC Current Gain

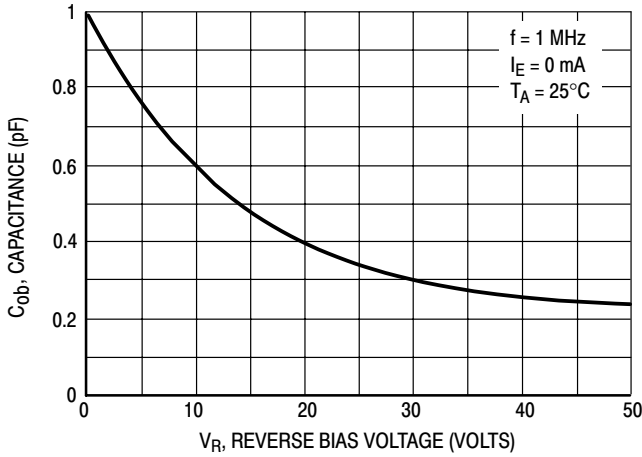

Figure 9. Output Capacitance

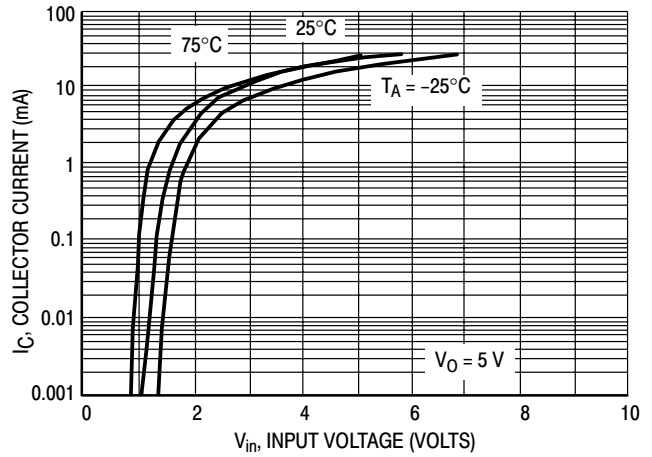

Figure 10. Output Current versus Input Voltage

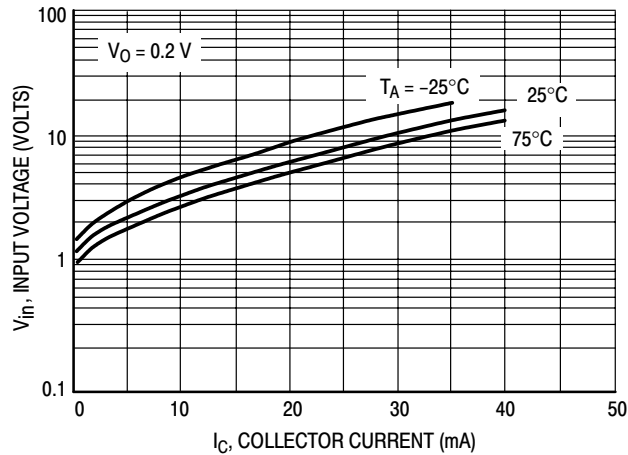
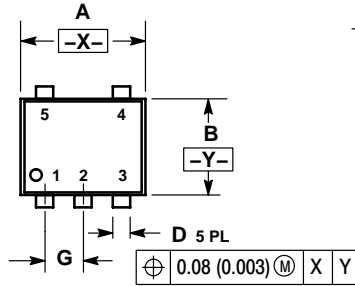

Figure 11. Input Voltage versus Output Current

NSTB1005DXV5T1, NSTB1005DXV5T5

PACKAGE DIMENSIONS

SOT-553
XV5 SUFFIX
 5-LEAD PACKAGE
 CASE 463B-01
 ISSUE A



- NOTES:
1. DIMENSIONING AND TOLERANCING PER ANSI Y14.5M, 1982.
 2. CONTROLLING DIMENSION: MILLIMETERS
 3. MAXIMUM LEAD THICKNESS INCLUDES LEAD FINISH THICKNESS. MINIMUM LEAD THICKNESS IS THE MINIMUM THICKNESS OF BASE MATERIAL.

DIM	MILLIMETERS		INCHES	
	MIN	MAX	MIN	MAX
A	1.50	1.70	0.059	0.067
B	1.10	1.30	0.043	0.051
C	0.50	0.60	0.020	0.024
D	0.17	0.27	0.007	0.011
G	0.50 BSC		0.020 BSC	
J	0.08	0.18	0.003	0.007
K	0.10	0.30	0.004	0.012
S	1.50	1.70	0.059	0.067

SOLDERING FOOTPRINT*

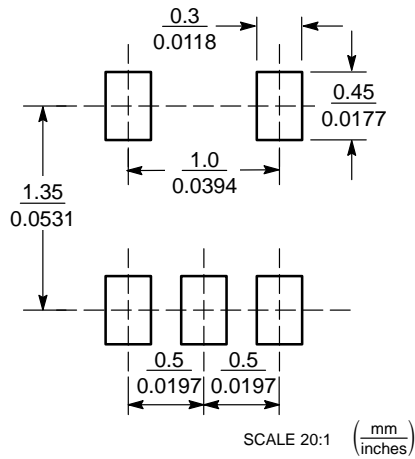

*For additional information on our Pb-Free strategy and soldering details, please download the ON Semiconductor Soldering and Mounting Techniques Reference Manual, SOLDERRM/D.

NSTB1005DXV5T1, NSTB1005DXV5T5

ON Semiconductor and  are registered trademarks of Semiconductor Components Industries, LLC (SCILLC). SCILLC reserves the right to make changes without further notice to any products herein. SCILLC makes no warranty, representation or guarantee regarding the suitability of its products for any particular purpose, nor does SCILLC assume any liability arising out of the application or use of any product or circuit, and specifically disclaims any and all liability, including without limitation special, consequential or incidental damages. "Typical" parameters which may be provided in SCILLC data sheets and/or specifications can and do vary in different applications and actual performance may vary over time. All operating parameters, including "Typicals" must be validated for each customer application by customer's technical experts. SCILLC does not convey any license under its patent rights nor the rights of others. SCILLC products are not designed, intended, or authorized for use as components in systems intended for surgical implant into the body, or other applications intended to support or sustain life, or for any other application in which the failure of the SCILLC product could create a situation where personal injury or death may occur. Should Buyer purchase or use SCILLC products for any such unintended or unauthorized application, Buyer shall indemnify and hold SCILLC and its officers, employees, subsidiaries, affiliates, and distributors harmless against all claims, costs, damages, and expenses, and reasonable attorney fees arising out of, directly or indirectly, any claim of personal injury or death associated with such unintended or unauthorized use, even if such claim alleges that SCILLC was negligent regarding the design or manufacture of the part. SCILLC is an Equal Opportunity/Affirmative Action Employer. This literature is subject to all applicable copyright laws and is not for resale in any manner.

PUBLICATION ORDERING INFORMATION

LITERATURE FULFILLMENT:

Literature Distribution Center for ON Semiconductor
P.O. Box 5163, Denver, Colorado 80217 USA

Phone: 303-675-2175 or 800-344-3860 Toll Free USA/Canada

Fax: 303-675-2176 or 800-344-3867 Toll Free USA/Canada

Email: orderlit@onsemi.com

N. American Technical Support: 800-282-9855 Toll Free
USA/Canada

Japan: ON Semiconductor, Japan Customer Focus Center

2-9-1 Kamimeguro, Meguro-ku, Tokyo, Japan 153-0051

Phone: 81-3-5773-3850

ON Semiconductor Website: <http://onsemi.com>

Order Literature: <http://www.onsemi.com/litorder>

For additional information, please contact your
local Sales Representative.

NSTB1005DXV5/D