

ASMT-Jx33

3W Mini Power LED Light Source



Data Sheet



Lead (Pb) Free
RoHS 6 fully
compliant

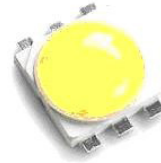

Description

The 3W Mini Power LED Light Source is a high performance energy efficient device which delivers high flux output and possesses high color rendering index. This device can handle high driving current. Option with electrically isolated metal slug is also available.

The White Mini Power LED is available in the range of color temperature from 2700K to 10000K.

The low profile package design and ultra small footprint is suitable for a wide variety of applications especially where space and height is a constraint.

The package is compatible with reflow soldering process. To facilitate easy pick & place assembly, the LEDs are packed in EIA-compliant tape and reel.

Features

- High Color Rendering Index (CRI)
- Available in Cool White, Neutral White and Warm White
- Small footprint and low profile
- Symmetrical outline
- Energy efficient
- Direct heat transfer from metal slug to mother board
- Compatible with reflow soldering process
- High current operation
- Long operation life
- Wide viewing angle
- Silicone encapsulation
- Non-ESD sensitive (threshold > 16kV)
- MSL 1 products

Applications

- Retail lighting
- Display case lighting
- Security lighting
- Commercial lighting such as window decorative lighting in shopping malls
- Architectural lighting

CAUTION: Customer is advised to keep the LEDs in the MBB when not in use as prolonged exposure to environment might cause the silver plated leads to tarnish, which might cause difficulties in soldering.

Package Dimensions

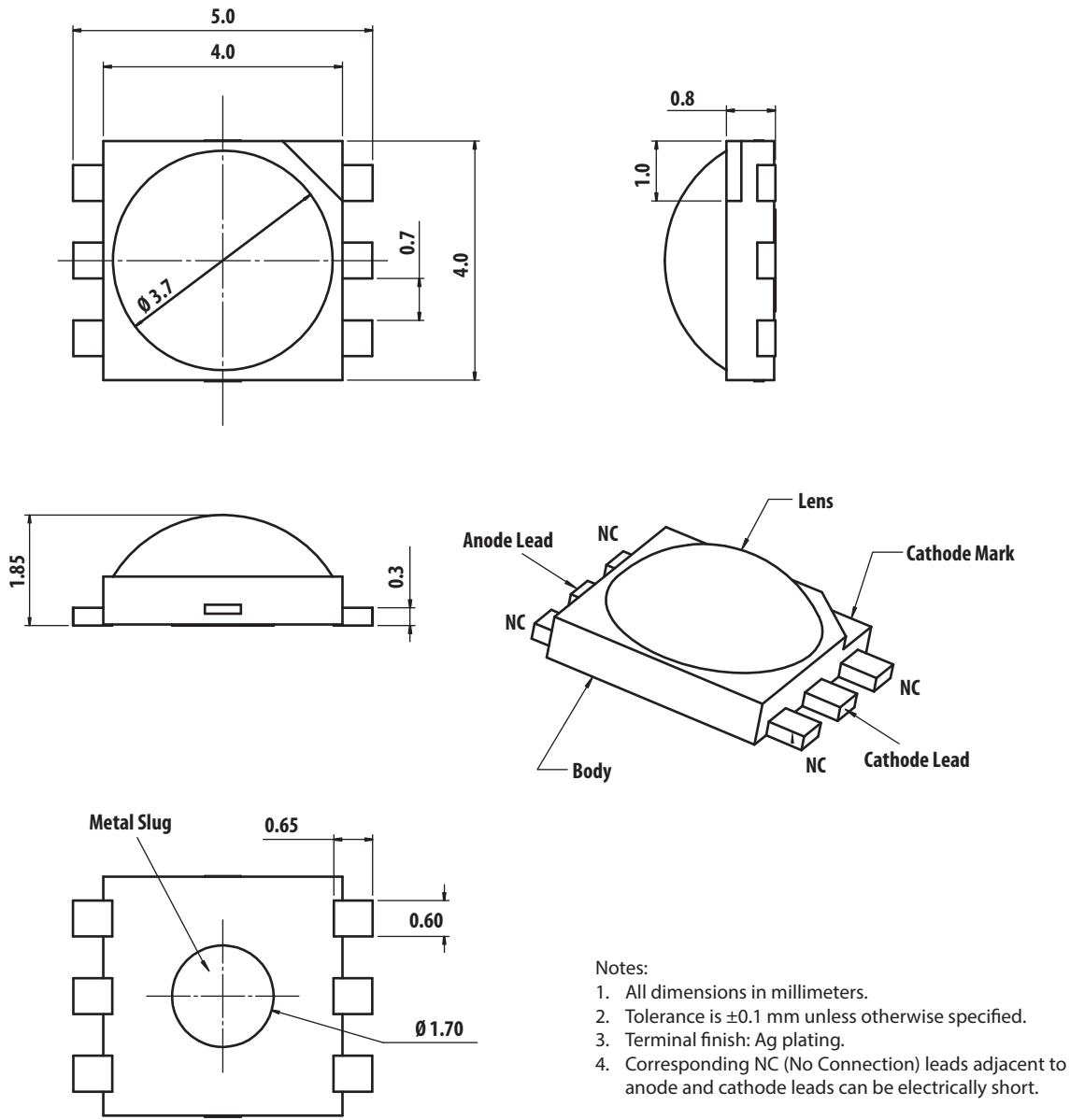
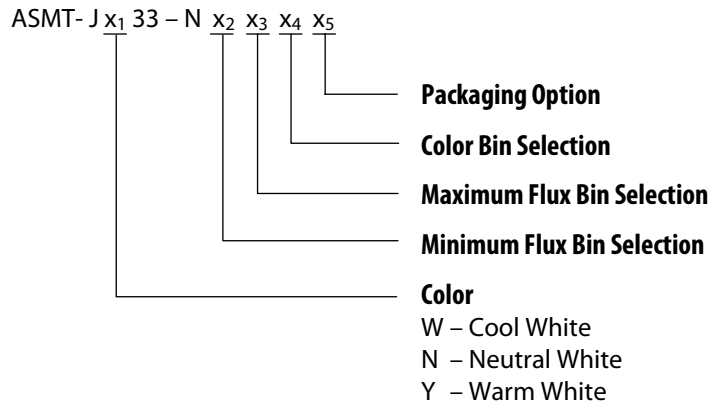

Figure 1. ASMT-Jx33 package outline drawing

Part Numbering System



Note:

1. Please refer to Page 7 for selection details.

Device Selection Guide (T_J = 25°C)

Part Number	Color	Luminous Flux (lm), Φ_V ^[1,2]			Test Current (mA)	Dice Technology	Electrically Isolated Metal Slug
		Min.	Typ.	Max.			
ASMT-JW33-NUV01	Cool White	87.4	100.0	113.6	350	InGaN	Yes
ASMT-JW33-NVW01		99.6	110.0	129.5	350	InGaN	Yes
ASMT-JN33-NUV01	Neutral White	87.4	100.0	113.6	350	InGaN	Yes
ASMT-JN33-NVW01		99.6	110.0	129.5	350	InGaN	Yes
ASMT-JY33-NRS01	Warm White	39.8	60.0	67.2	350	InGaN	Yes
ASMT-JY33-NSTJ1		51.7	70.0	87.4	350	InGaN	Yes
ASMT-JY33-NTU01		67.2	90.0	99.6	350	InGaN	Yes

Notes:

1. Φ_V is the total luminous flux output as measured with an integrating sphere at 25ms mono pulse condition.
2. Flux tolerance is $\pm 10\%$

Absolute Maximum Ratings

Parameter	InGaN	Units
DC Forward Current ^[1]	700	mA
Peak Pulsing Current	2400	mA
Power Dissipation	2730	mW
LED Junction Temperature	135	°C
Operating Metal Slug Temperature Range at 350 mA	-40 to +120	°C
Operating Metal Slug Temperature Range at 700 mA	-40 to +105	°C
Storage Temperature Range	-40 to +120	°C
Soldering Temperature	Refer to Figure 14	
Reverse Voltage ^[2]	Not recommended	

Notes:

1. Derate linearly based on Figure 10.
2. Not designed for reverse bias operation.

Optical Characteristics at 350 mA (T_J = 25°C)

Part Number	Color	Correlated Color Temperature, CCT (Kelvin)		Viewing Angle, 2θ _½ ^[1] (°)	Luminous Efficiency (lm/W)	Color Rendering Index, CRI
		Min.	Max.	Typ.	Typ.	Typ.
ASMT-JW33-NUV01	Cool White	4500	10000	140	89	80
ASMT-JW33-NVW01		4500	10000	140	98	80
ASMT-JN33-NUV01	Neutral White	3500	4500	140	89	80
ASMT-JN33-NVW01		3500	4500	140	98	80
ASMT-JY33-NRS01	Warm White	2700	3500	140	54	90
ASMT-JY33-NSTJ1		2850	3250	140	63	85
ASMT-JY33-NTU01		2700	3500	140	80	85

Note:

1. θ_½ is the off-axis angle where the luminous intensity is ½ the peak intensity.

Electrical Characteristic at 350 mA (T_J = 25°C)

Dice Type	Forward Voltage, V _F (Volts)			Thermal Resistance, R _{θJ-MS} (°C/W) ^[1]
	Min.	Typ	Max.	Typ.
InGaN	2.8	3.2	3.5	9

Note:

1. R_{θJ-MS} is Thermal Resistance from LED junction to metal slug.

Optical and Electrical Characteristic at 700 mA (T_J = 25°C)

Part Number	Color	Luminous Flux (lm), φ _v	Forward Voltage, V _F (Volts)
		Typ.	Typ.
ASMT-JW33-NUV01	Cool White	178.0	3.6
ASMT-JW33-NVW01		196.0	3.6
ASMT-JN33-NUV01	Neutral White	178.0	3.6
ASMT-JN33-NVW01		196.0	3.6
ASMT-JY33-NRS01	Warm White	107.0	3.6
ASMT-JY33-NSTJ1		125.0	3.6
ASMT-JY33-NTU01		160.0	3.6

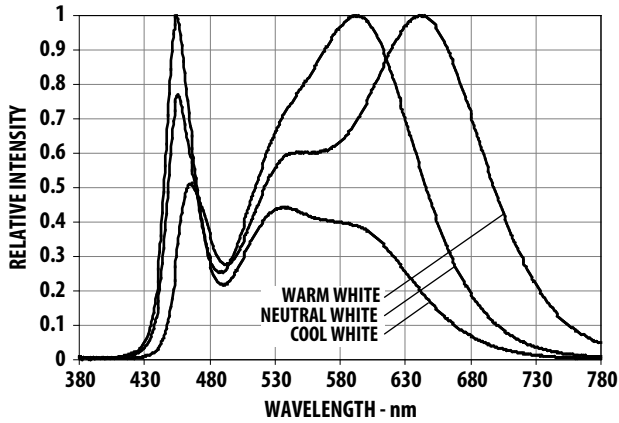

Figure 2. Relative Intensity vs. Wavelength for Cool White and Warm White

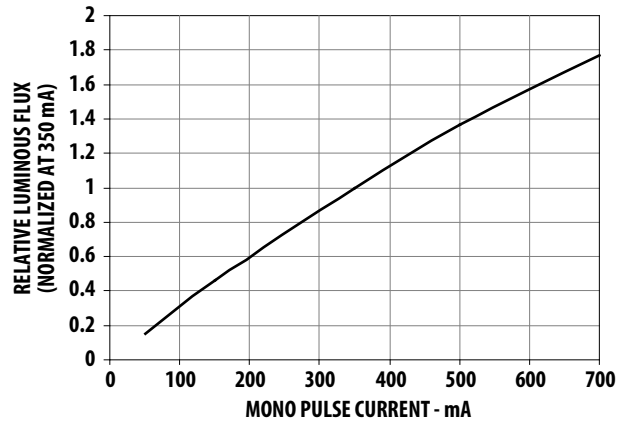

Figure 3. Relative Luminous Flux vs. Mono Pulse Current

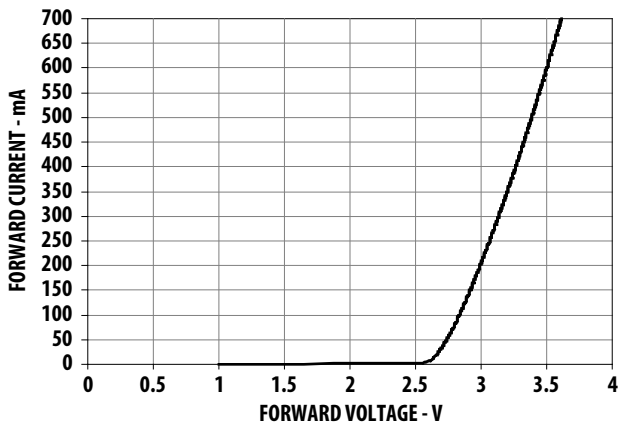

Figure 4. Forward Current vs. Forward Voltage

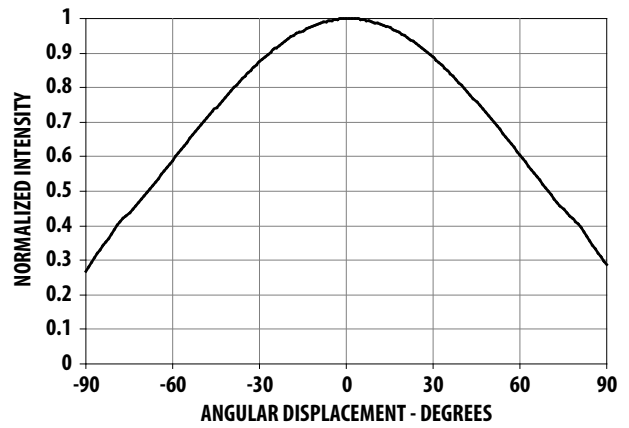

Figure 5. Radiation Pattern for Cool White, Warm White and Neutral White

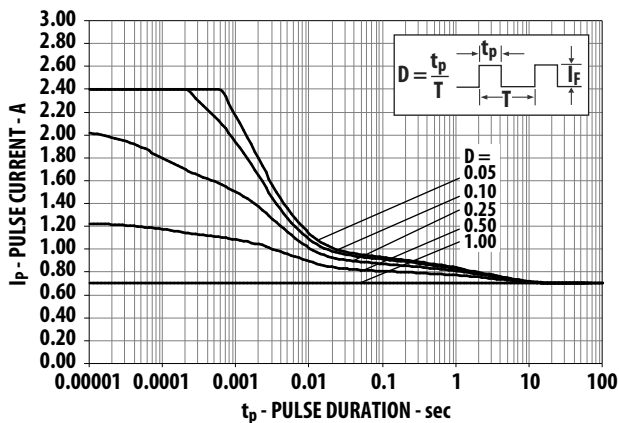

Figure 6. Maximum pulse current vs. pulse duration. Derated based on $T_A = 25^\circ\text{C}$, $R_{\theta J-A} = 30^\circ\text{C/W}$.

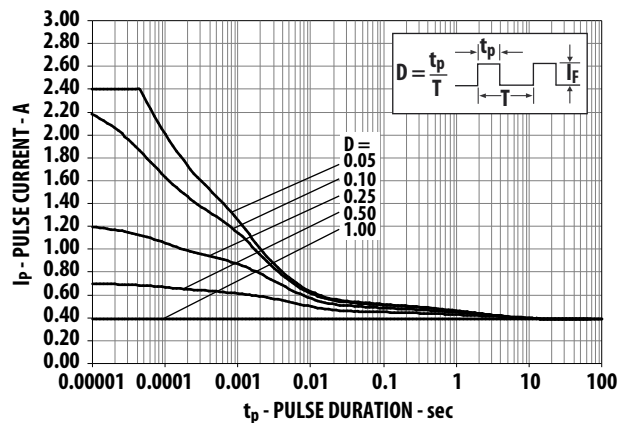

Figure 7. Maximum pulse current vs. pulse duration. Derated based on $T_A = 85^\circ\text{C}$, $R_{\theta J-A} = 30^\circ\text{C/W}$.

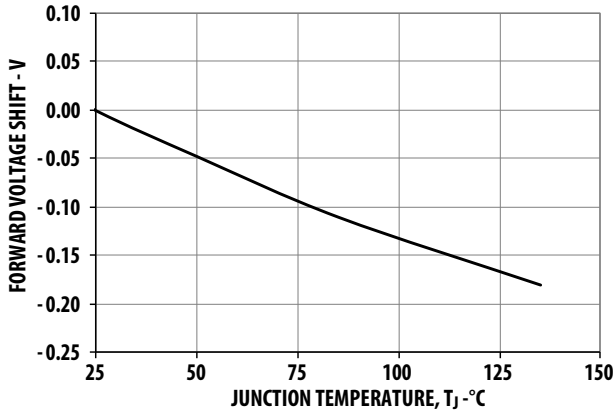

Figure 8. Forward Voltage Shift vs. Junction Temperature

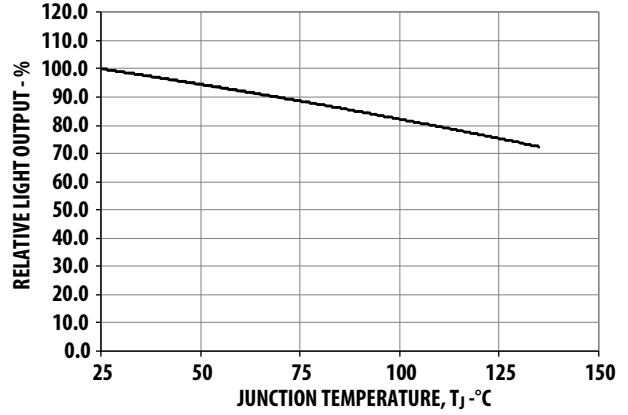

Figure 9. Relative Light Output vs. Junction Temperature.

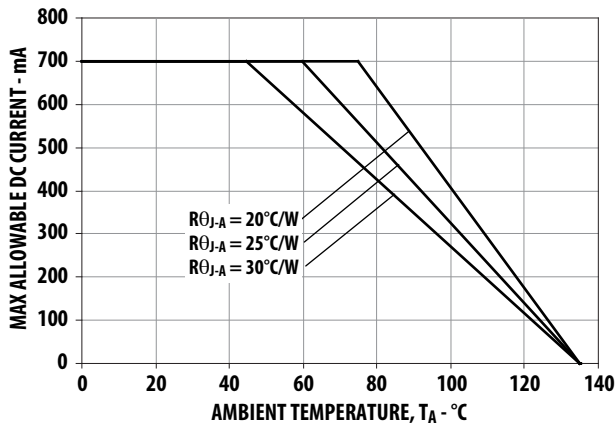

Figure 10. Maximum Forward Current vs. Ambient Temperature. Derated based on $T_{JMAX} = 125^\circ\text{C}$, $R_{\theta J-A} = 20^\circ\text{C/W}$, 25°C/W and 30°C/W

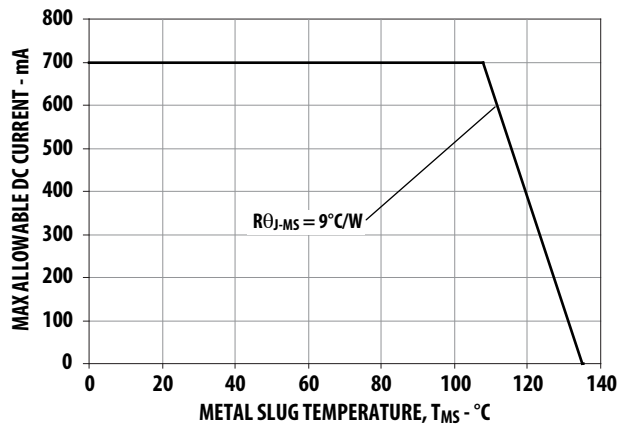

Figure 11. Maximum Forward Current vs. Metal Slug Temperature. Derated based on $T_{JMAX} = 125^\circ\text{C}$, $R_{\theta J-MS} = 9^\circ\text{C/W}$

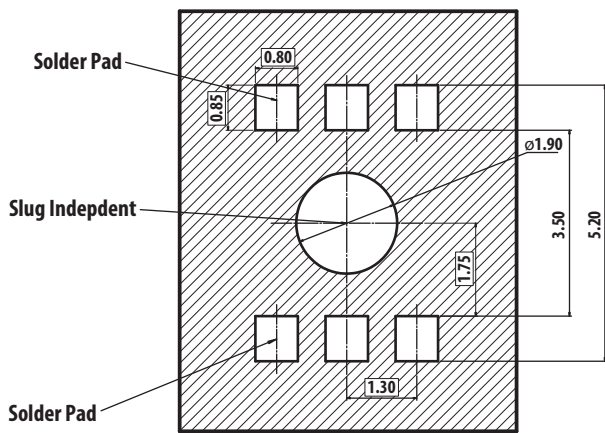

Figure 12. Recommended soldering land pattern

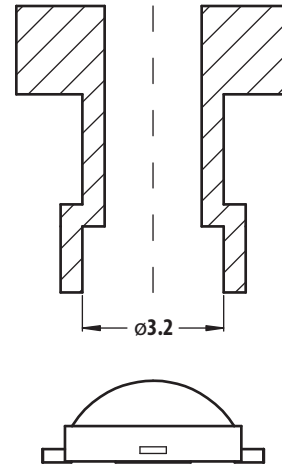

Figure 13. Recommended pick and place nozzle tip. Inner diameter = 3.2 mm

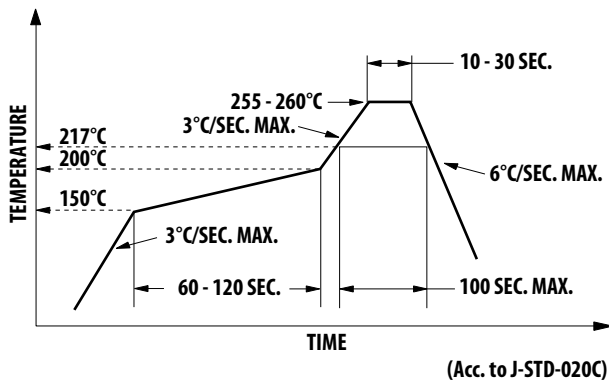

Figure 14. Recommended Reflow Soldering Profile

Note:

For detail information on reflow soldering of Avago surface mount LEDs, do refer to Avago Application Note AN1060 Surface Mounting SMT LED Indicator Components.

Option Selection Details

ASMT-J x₁ 33 – N x₂ x₃ x₄ x₅

x₂ – Minimum Flux Bin Selection

x₃ – Maximum Flux Bin Selection

x₄ – Color Bin Selection

x₅ – Packaging Option

Flux Bin Limit [x₂, x₃]

Bin ID	Luminous Flux (lm) at 350 mA	
	Min.	Max.
Q	30.6	39.8
R	39.8	51.7
S	51.7	67.2
T	67.2	87.4
U	87.4	99.6
V	99.6	113.6
W	113.6	129.5

Tolerance for each bin limits is ±10%

Color Bin Selection [x₄]

Individual reel will contain parts from one color bin selection only.

Cool White

Selection	Bin ID
0	Full Distribution
H	UN, VN, U0 and V0
J	WN, VN, W0 and V0
K	XN, WN, X0 and W0
P	Y0

Warm White

Selection	Bin ID
0	Full Distribution
H	M1, N1, M0 and N0
J	P1, N1, P0 and N0
K	Q1, P1, Q0 and P0

Neutral White

Selection	Bin ID
0	Full Distribution
G	S1, R1, S0 and R0
H	TN, S1, T0 and S0

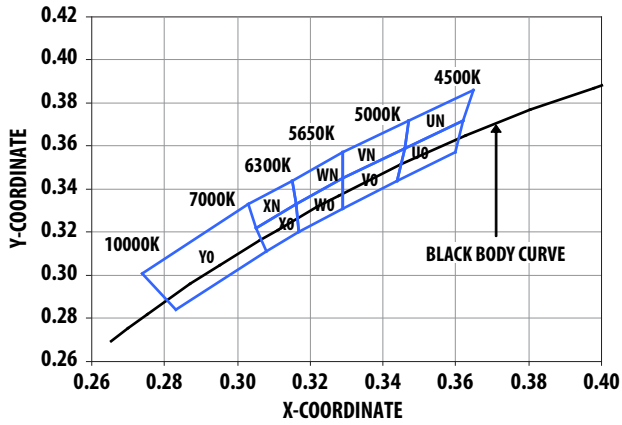

Figure 15. Color bin Structure for Cool White

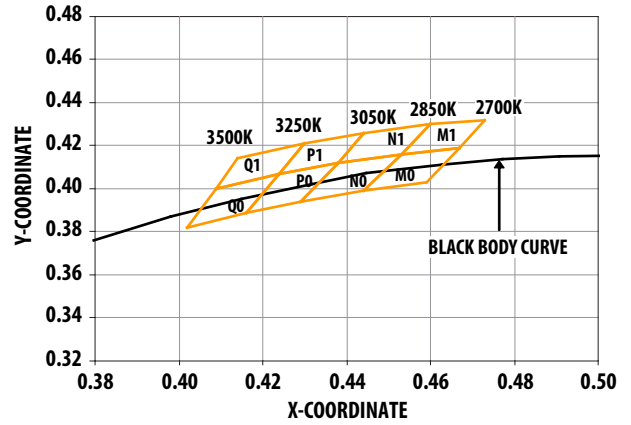

Figure 16. Color bin structure for Warm White

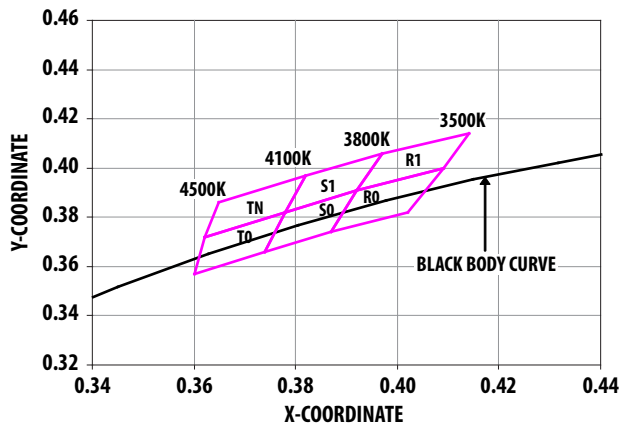

Figure 17. Color bin structure for Neutral White

Color Bin Limits

Cool White	Color Limits (Chromaticity Coordinates)				
Bin UN	x	0.365	0.362	0.346	0.347
	y	0.386	0.372	0.359	0.372
Bin UO	x	0.362	0.360	0.344	0.346
	y	0.372	0.357	0.344	0.359
Bin VN	x	0.329	0.329	0.347	0.346
	y	0.345	0.357	0.372	0.359
Bin VO	x	0.329	0.329	0.346	0.344
	y	0.331	0.345	0.359	0.344
Bin WN	x	0.329	0.316	0.315	0.329
	y	0.345	0.333	0.344	0.357
Bin W0	x	0.329	0.329	0.317	0.316
	y	0.345	0.331	0.320	0.333
Bin XN	x	0.305	0.303	0.315	0.316
	y	0.322	0.333	0.344	0.333
Bin XO	x	0.308	0.305	0.316	0.317
	y	0.311	0.322	0.333	0.320
Bin YO	x	0.308	0.283	0.274	0.303
	y	0.311	0.284	0.301	0.333

Tolerance: ± 0.01

Neutral White	Color Limits (Chromaticity Coordinates)				
Bin R1	x	0.414	0.409	0.392	0.397
	y	0.414	0.400	0.391	0.406
Bin R0	x	0.392	0.387	0.402	0.409
	y	0.391	0.374	0.382	0.400
Bin S1	x	0.397	0.392	0.378	0.382
	y	0.406	0.391	0.382	0.397
Bin S0	x	0.392	0.387	0.374	0.378
	y	0.391	0.374	0.366	0.382
Bin TN	x	0.382	0.378	0.362	0.365
	y	0.397	0.382	0.372	0.386
Bin T0	x	0.378	0.374	0.360	0.362
	y	0.382	0.366	0.357	0.372

Tolerance: ± 0.01

Warm White	Color Limits (Chromaticity Coordinates)				
Bin M1	x	0.460	0.453	0.467	0.473
	y	0.430	0.416	0.419	0.432
Bin M0	x	0.453	0.444	0.459	0.467
	y	0.416	0.399	0.403	0.419
Bin N1	x	0.444	0.438	0.453	0.460
	y	0.426	0.412	0.416	0.430
Bin N0	x	0.438	0.429	0.444	0.453
	y	0.412	0.394	0.399	0.416
Bin P1	x	0.430	0.424	0.438	0.444
	y	0.421	0.407	0.412	0.426
Bin P0	x	0.424	0.416	0.429	0.438
	y	0.407	0.389	0.394	0.412
Bin Q1	x	0.414	0.409	0.424	0.430
	y	0.414	0.400	0.407	0.421
Bin Q0	x	0.409	0.402	0.416	0.424
	y	0.400	0.382	0.389	0.407

Tolerance: ± 0.01

Packaging Option [x5]

Selection	Option
1	Tape and Reel

Example

ASMT-JW33-NSU01

ASMT-JW33-Nxxxx – Cool White, InGaN,
Electrically isolated Heat Sink

- $X_2 = S$ – Minimum Flux Bin S
- $X_3 = U$ – Maximum Flux Bin U
- $X_4 = 0$ – Full Distribution
- $X_5 = 1$ – Tape and Reel Option

Tape and Reel – Option 1

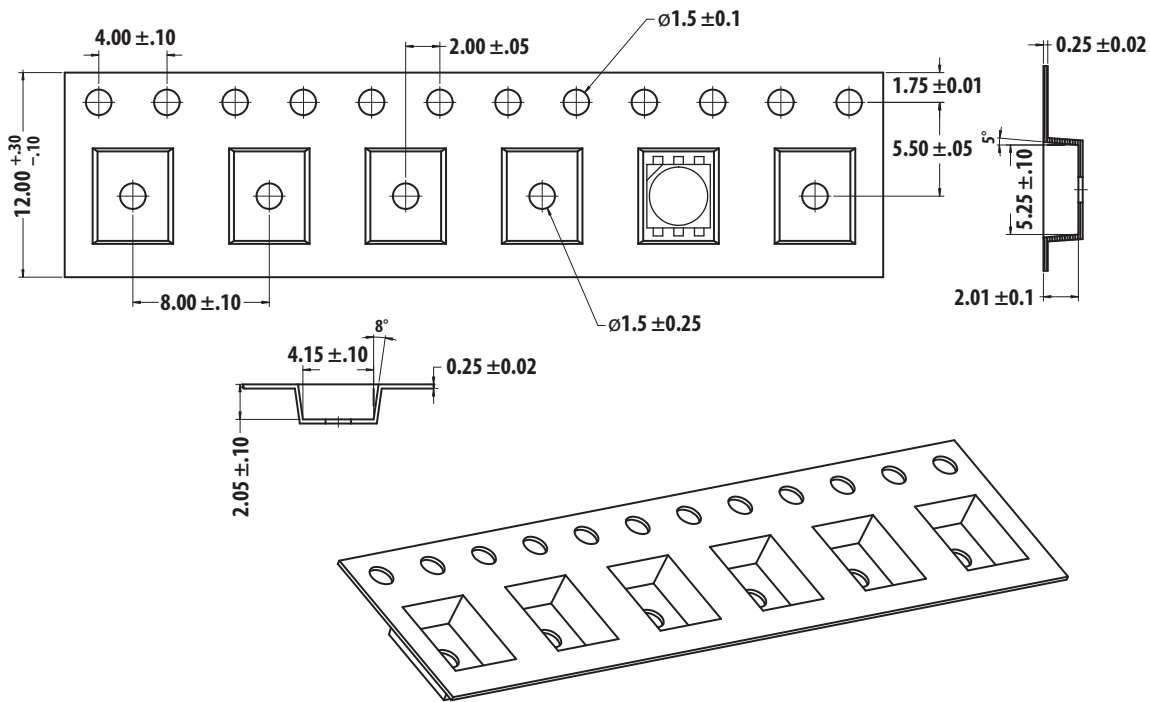
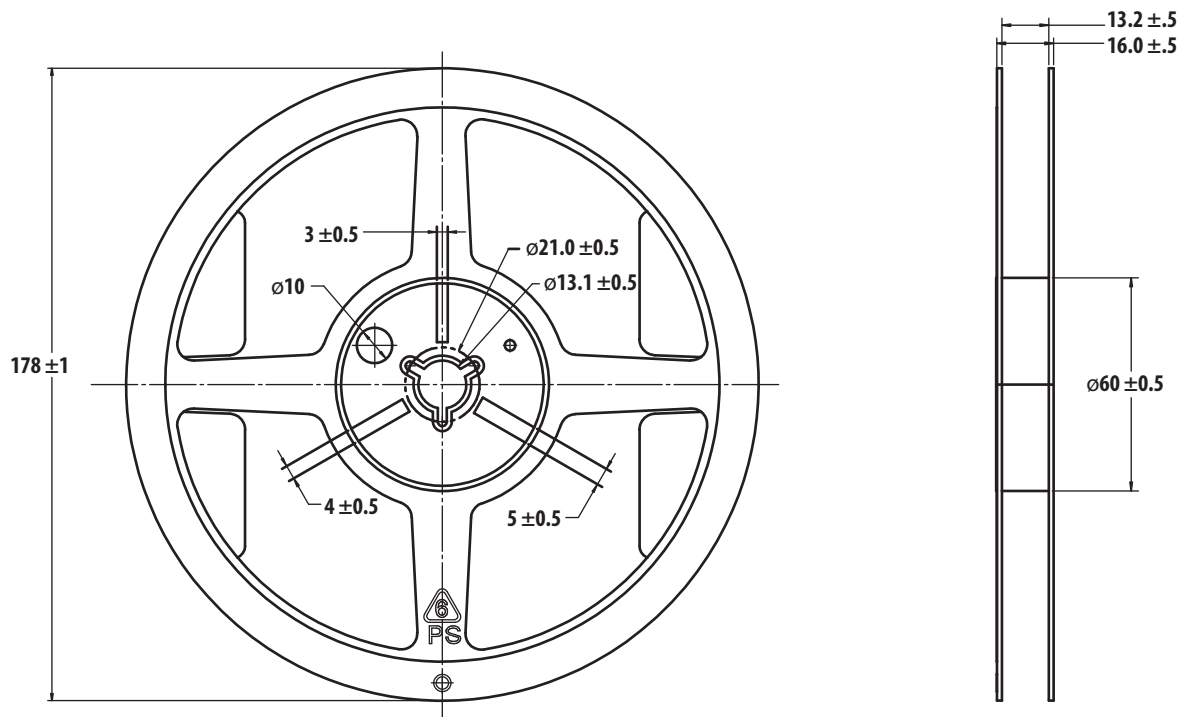

Figure 18. Carrier Tape Dimensions



Notes:

1. Empty component pockets sealed with top cover tape.
2. 250 or 500 pieces per reel.
3. Drawing not to scale.
4. All dimensions are in millimeters.

Figure 19. Reel dimensions

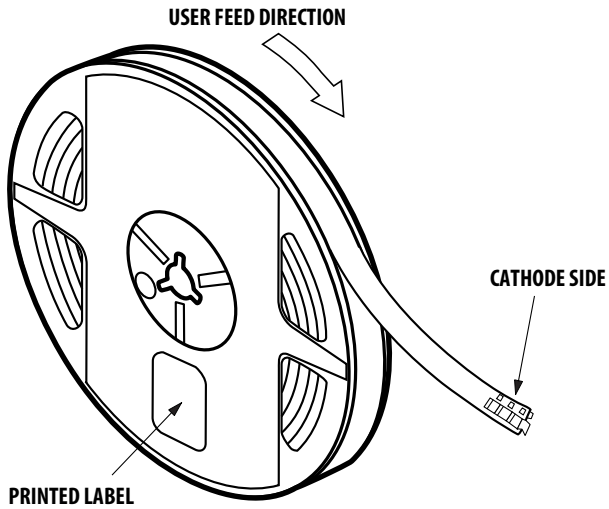

Figure 20. Reeling Orientation

DISCLAIMER: Avago's products and software are not specifically designed, manufactured or authorized for sale as parts, components or assemblies for the planning, construction, maintenance or direct operation of a nuclear facility or for use in medical devices or applications. Customer is solely responsible, and waives all rights to make claims against avago or its suppliers, for all loss, damage, expense or liability in connection with such use.

For product information and a complete list of distributors, please go to our web site: www.avagotech.com

Avago, Avago Technologies, and the A logo are trademarks of Avago Technologies in the United States and other countries. Data subject to change. Copyright © 2005-2014 Avago Technologies. All rights reserved.
AV02-2430EN - December 1, 2014

AVAGO
TECHNOLOGIES