



Features:

- 12 dB Gain
- 44 dBm and LSG ≥ 7.0 dB CW
- OIP3 ≥ 54 dBm at 38 dBm per tone
- PAE 32% at 44 dBm
- Matched Input and Output for Easy Cascade
- Surface Mount Package with RoHS Compliance
- Thermal Resistance is 2.0°C/W
- MTTF > 100 years @ 85°C ambient temperature

Applications:

- Point-To-Point Radio
- Wireless Connectivity

Description:

MwT's MGA-718544-HP3 is a 25W GaN power amplifier. Operating from 7.1 to 8.5 GHz, the amplifier's CW RF power output is 25W typical and PAE of 32%. The amplifier's RF input and output are matched to 50 Ω . External bias tees are required. The OIP3 is 54 dBm (38 dBm per tone).

The MGA-718544-HP3 packaged base is a solid copper offering superior thermal management. The overall Rth is 2.0°C/W.

Typical RF Performance: $V_{ds}=28V, V_{gs}=-2.27V, I_{dq}=300mA, T_a=+25^\circ C (2), Z_0=50\ ohm$

Parameter	Units	Typical Data
Frequency Range	MHz	7100-8500
Gain (Typ / Min)	dB	13.5 / 11
Gain Flatness (Typ / Max)	+/-dB	1.0 / 1.5
Input Return Loss	dB	4.5
Output Return Loss	dB	6.0
Output P3dB	dBm	44.0
OIP3(1)	dBm	54
Operating Current Range	A	2.4
Thermal Resistance	°C /W	2.0

(1) Output IP3 is measured with two tones at output power of 36 dBm/tone separated by 10 MHz.

Typical RF Performance: $V_{ds}=28.0V$, $I_{dq}=250mA$ $Z_0=50\ ohm$, $T_a=+25\ ^\circ C$

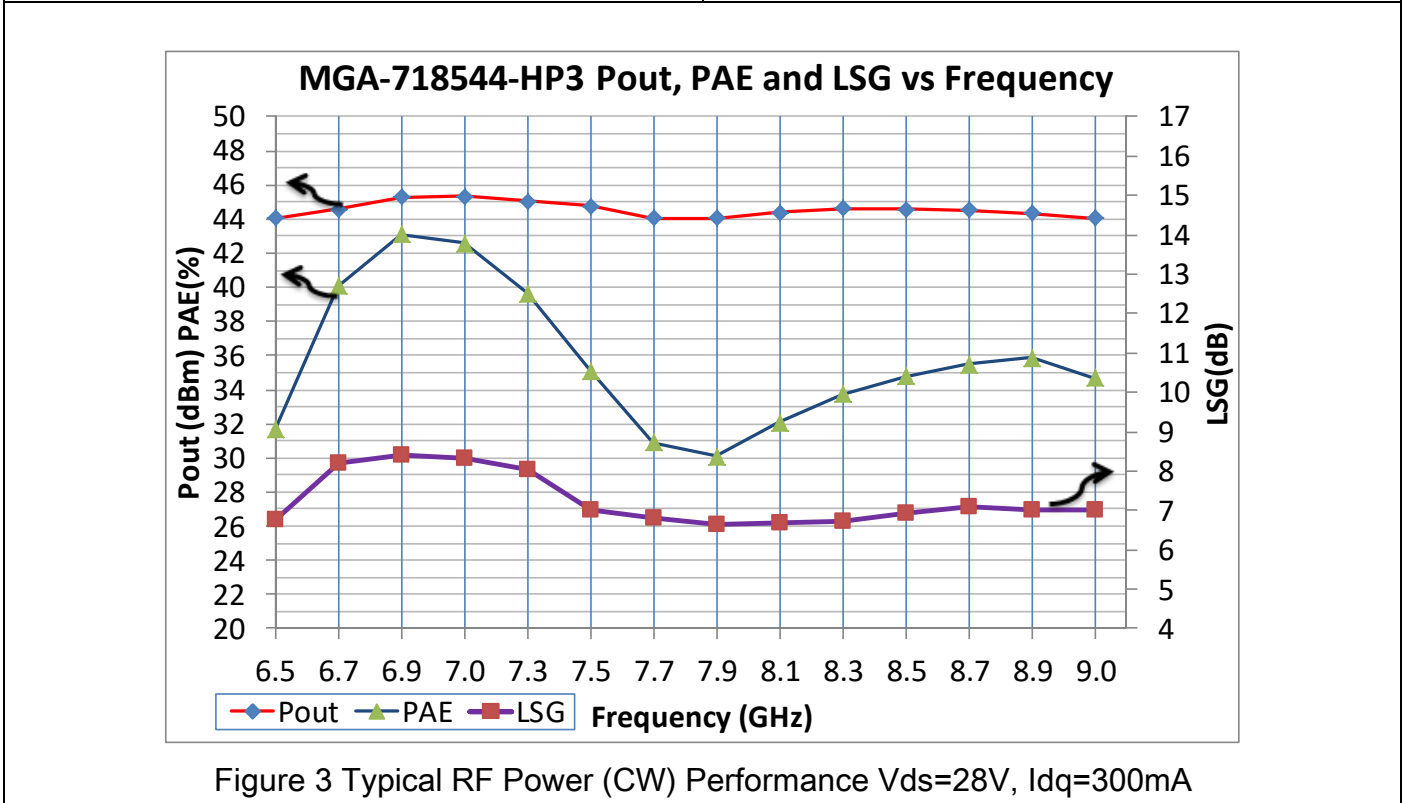
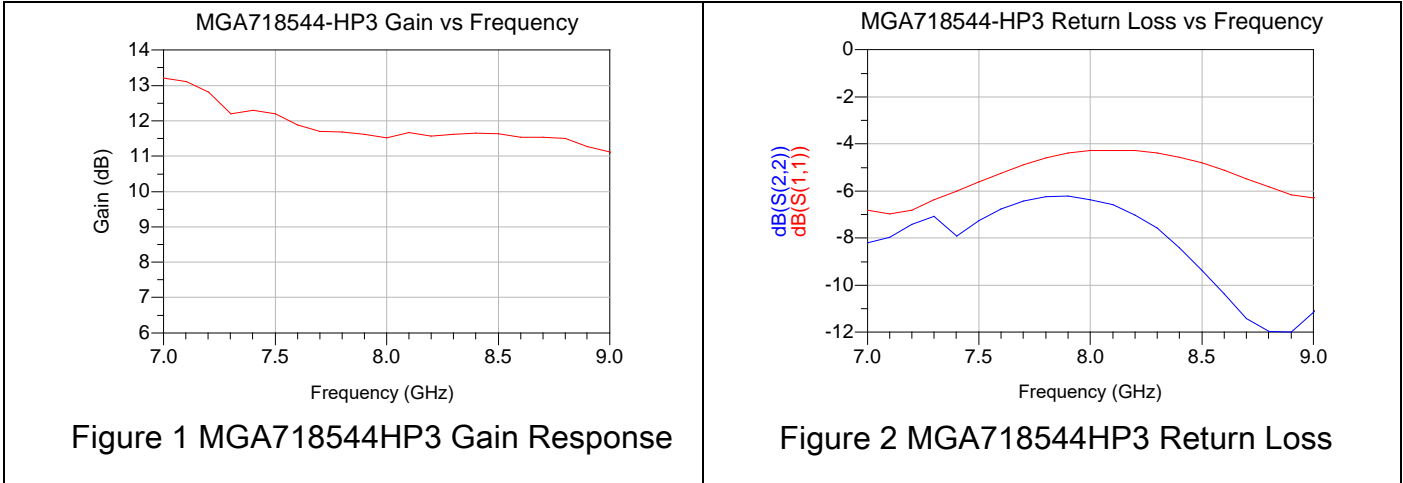
Figure 3 Typical RF Power (CW) Performance $V_{ds}=28V$, $I_{dq}=300mA$

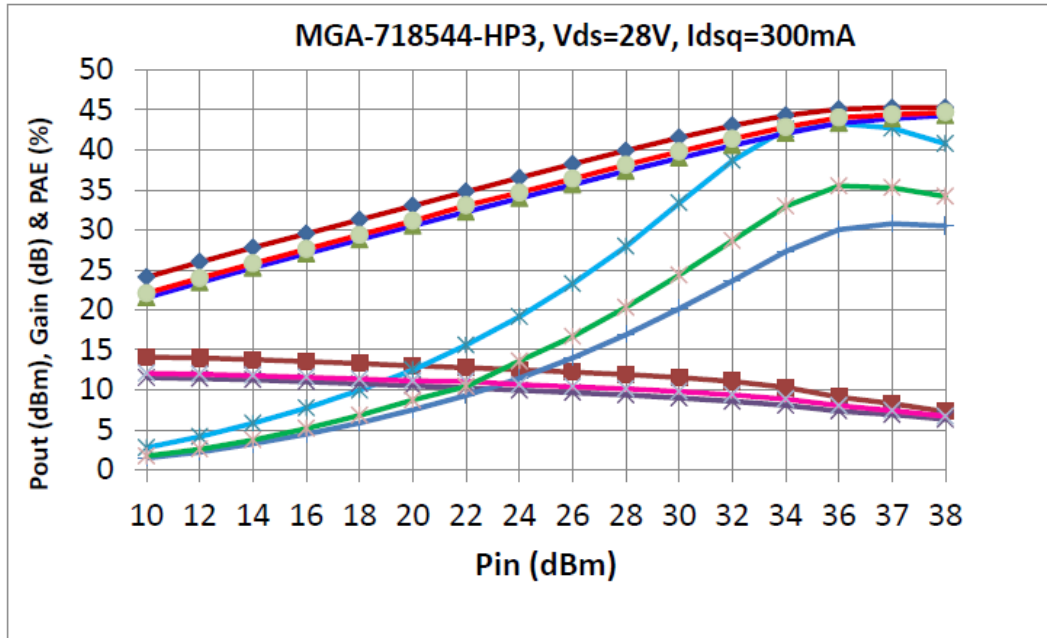

Figure 4 Pout, Gain, and PAE vs Pin

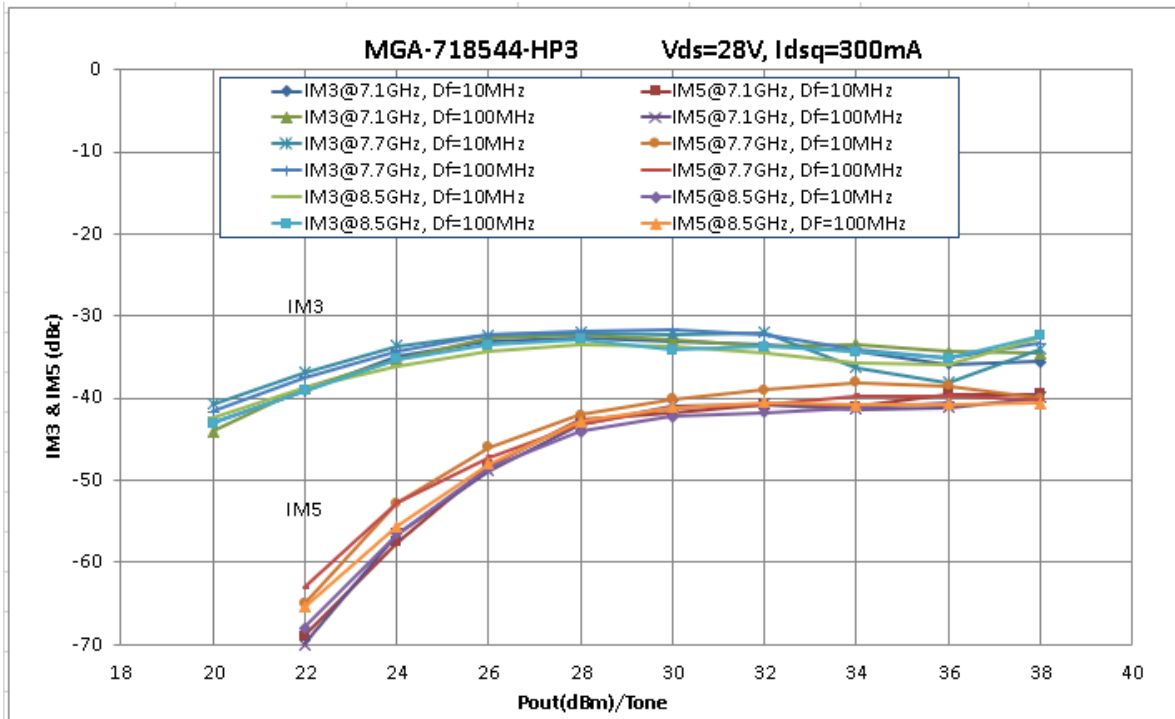
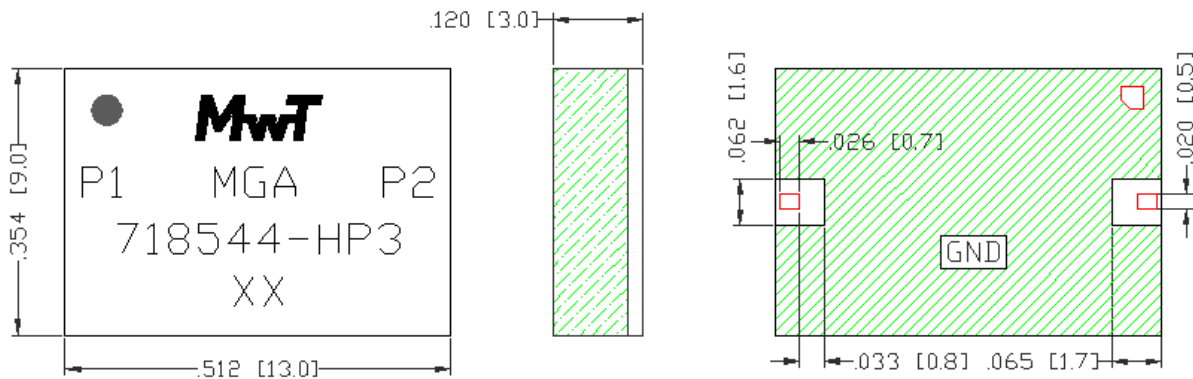

Figure 5 IMD3 and IMD5 vs Power per Tone Vdd=28V Idq=300mA



Mechanical Information: *This Package is RoHS compliant*



Pin	Functions
1	RF in, Vgs feed in
2	RF out, Vds feed in
GND	The GND area of the bottom should be thermally and electrically grounded

Absolute Maximum Ratings: ($T_a = 25\text{ }^\circ\text{C}$)*

SYMBOL	PARAMETERS	UNITS	ABSOLUTE MAXIMUM
Vds	Drain-Source Voltage	V	29
Id	Drain Current	mA	5500
Ig	Gate Current	mA	3.0
Pdiss	DC Power Dissipation	W	83
Pin max	RF Input Power	dBm	+38
Tch	Channel Temperature	°C	225
Tstg	Storage Temperature	°C	-55 to 125

*Operation of this device above any one of these parameters may cause permanent damage.

Application Circuit and Board Design

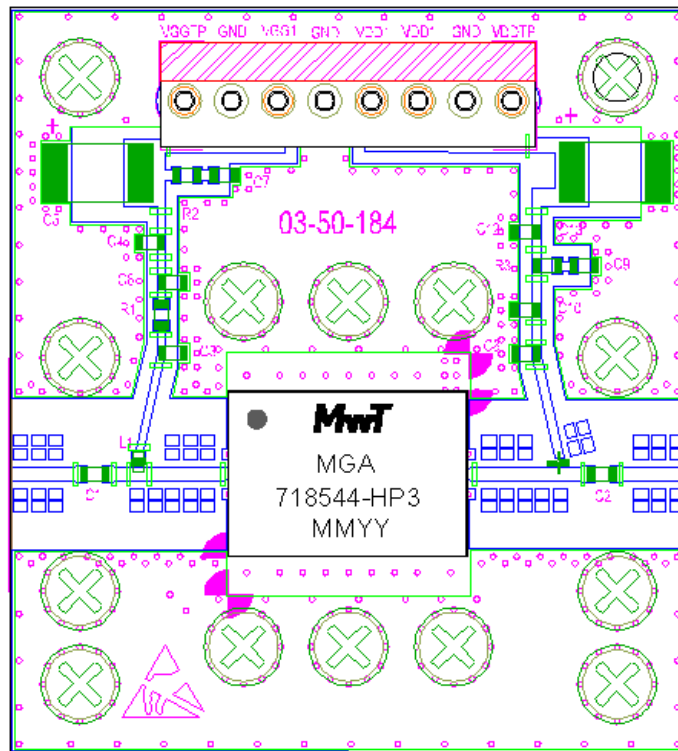
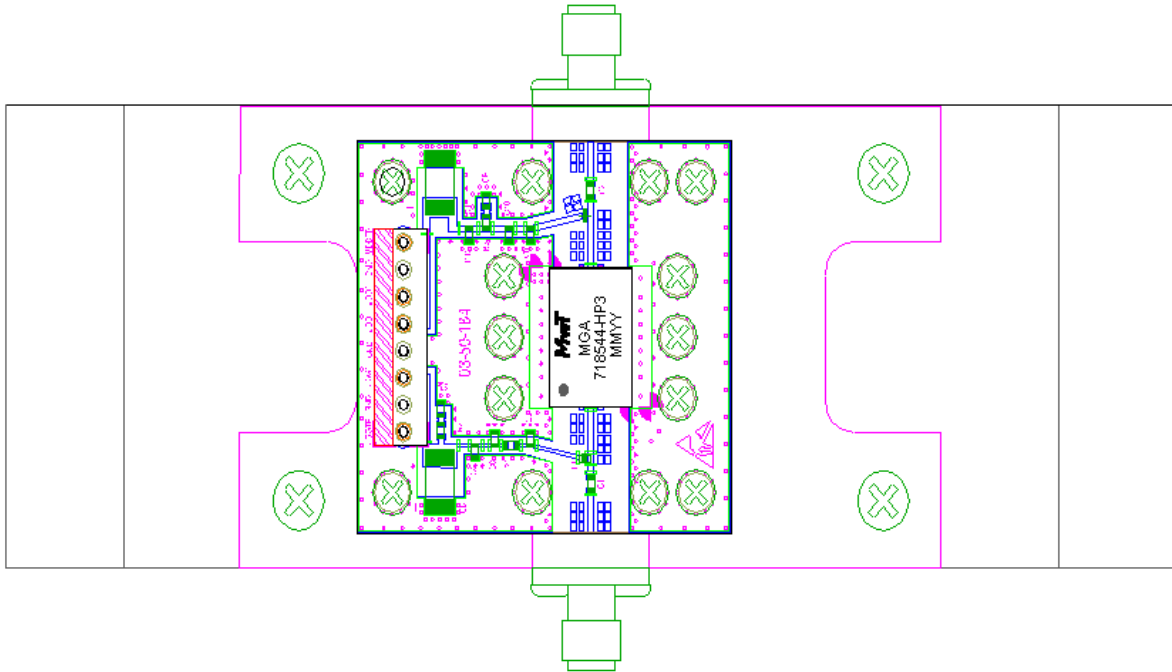

Item	Quantity	Description	Vendor P/N	MwT P/N	Ref No.
		HP3 25 Watt AMPLIFIER	MGA-718544-HP3		
1	1	MGA-718544-HP3		01-31-043	
2	1	CONNECTOR, 8 PIN	640456-8		P1
3	1	COVER		04-071037	
4	1	COIL 3 TURN	3-5038-A	03-02-307	L2
5	1	COIL 6.8nH	0402DC-6N8X-R	03-02-302	L1
6	4	CAPACITOR .1 uF	GRM155R61H104KE19D	03-02-306	C6,7,9,12
7	1	CAPACITOR 1000 pF	C0603C102K5RACTU	03-02-305	C4, 10
8	4	CAPACITOR 2 pF	ML03512R08AT2A	03-02-304	C1,2,3,8
9	2	CAPACITOR 1.0 uF	T491C105K050AT	03-02-004	C5,C13
10	2	RESISTOR 51 OHMS	ERJ-2GEJ510X	03-02-307	R1,2,3
11	1	PALLET MOUNT		04-20-415	
12	1	HEAT SINK		04-20-405	
13	4	SCREWS 4-40, PHD PHIL			
14	14	SCREWS 2-56, PHD PHIL			
15	A/R	SOLDER 60/40		06-08-001	

Electrical Schematics

