



# BSS138P

60 V, 360 mA N-channel Trench MOSFET

Rev. 1 — 2 November 2010

Product data sheet

## 1. Product profile

### 1.1 General description

N-channel enhancement mode Field-Effect Transistor (FET) in a small SOT23 (TO-236AB) Surface-Mounted Device (SMD) plastic package using Trench MOSFET technology.

### 1.2 Features and benefits

- Logic-level compatible
- Very fast switching
- Trench MOSFET technology
- AEC-Q101 qualified

### 1.3 Applications

- Relay driver
- High-speed line driver
- Low-side loadswitch
- Switching circuits

### 1.4 Quick reference data

Table 1. Quick reference data

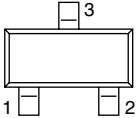
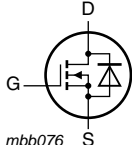
| Symbol       | Parameter                        | Conditions  | Min | Typ | Max      | Unit     |
|--------------|----------------------------------|---|-----|-----|----------|----------|
| $V_{DS}$     | drain-source voltage             | $T_{amb} = 25\text{ °C}$  | -   | -   | 60       | V        |
| $V_{GS}$     | gate-source voltage              | $T_{amb} = 25\text{ °C}$  | -   | -   | $\pm 20$ | V        |
| $I_D$        | drain current                    | $T_{amb} = 25\text{ °C};$<br>$V_{GS} = 10\text{ V}$                       | [1] | -   | 360      | mA       |
| $R_{DS(on)}$ | drain-source on-state resistance | $T_j = 25\text{ °C};$<br>$V_{GS} = 10\text{ V};$<br>$I_D = 300\text{ mA}$ | [2] | 0.9 | 1.6      | $\Omega$ |

[1] Device mounted on an FR4 Printed-Circuit Board (PCB), single-sided copper, tin-plated, mounting pad for drain 1 cm<sup>2</sup>.

[2] Pulse test:  $t_p \leq 300\text{ }\mu\text{s}$ ;  $\delta \leq 0.01$ .

## 2. Pinning information

Table 2. Pinning

| Pin | Symbol | Description | Simplified outline  | Graphic symbol  |
|-----|--------|-------------|---|---|
| 1   | G      | gate        |  | <br>mbb076 |
| 2   | S      | source      |   |   |
| 3   | D      | drain       |   |   |

## 3. Ordering information

Table 3. Ordering information

| Type number | Package  |  |         |
|-------------|----------|--|---------|
|             | Name     | Description                              | Version |
| BSS138P     | TO-236AB | plastic surface-mounted package; 3 leads | SOT23   |

## 4. Marking

Table 4. Marking codes

| Type number | Marking code <sup>[1]</sup> |
|-------------|-----------------------------|
| BSS138P     | AN*                         |

[1] \* = placeholder for manufacturing site code

## 5. Limiting values

Table 5. Limiting values

In accordance with the Absolute Maximum Rating System (IEC 60134).

| Symbol   | Parameter            | Conditions   | Min | Max | Unit |
|----------|----------------------|--|-----|-----|------|
| $V_{DS}$ | drain-source voltage | $T_{amb} = 25\text{ °C}$   | -   | 60  | V    |
| $V_{GS}$ | gate-source voltage  | $T_{amb} = 25\text{ °C}$   | -   | ±20 | V    |
| $I_D$    | drain current        | $V_{GS} = 10\text{ V}$   | [1] |     |      |
|          |                      | $T_{amb} = 25\text{ °C}$   | -   | 360 | mA   |
|          |                      | $T_{amb} = 100\text{ °C}$  | -   | 230 | mA   |
| $I_{DM}$ | peak drain current   | $T_{amb} = 25\text{ °C}$ ;<br>single pulse; $t_p \leq 10\text{ }\mu\text{s}$ | -   | 1.2 | A    |

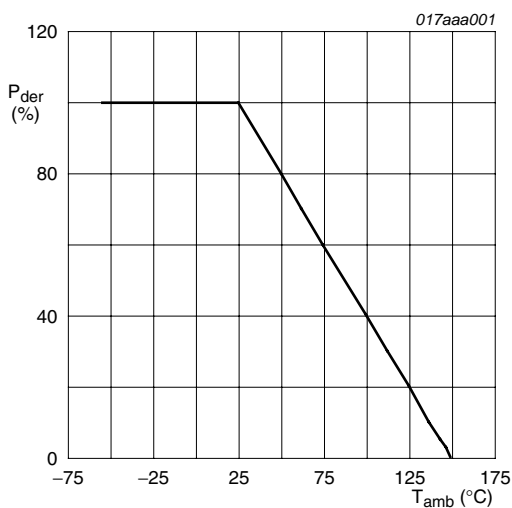
**Table 5. Limiting values ...continued**

In accordance with the Absolute Maximum Rating System (IEC 60134).

| Symbol                    | Parameter               | Conditions               | Min   | Max  | Unit |
|---------------------------|-------------------------|--------------------------|-------|------|------|
| P <sub>tot</sub>          | total power dissipation | T <sub>amb</sub> = 25 °C | [2] - | 350  | mW   |
|                           |                         |                          | [1] - | 420  | mW   |
|                           |                         | T <sub>sp</sub> = 25 °C  | -     | 1140 | mW   |
| T <sub>j</sub>            | junction temperature    |                          |       | 150  | °C   |
| T <sub>amb</sub>          | ambient temperature     |                          | -55   | +150 | °C   |
| T <sub>stg</sub>          | storage temperature     |                          | -65   | +150 | °C   |
| <b>Source-drain diode</b> |                         |                          |       |      |      |
| I <sub>S</sub>            | source current          | T <sub>amb</sub> = 25 °C | [1] - | 360  | mA   |

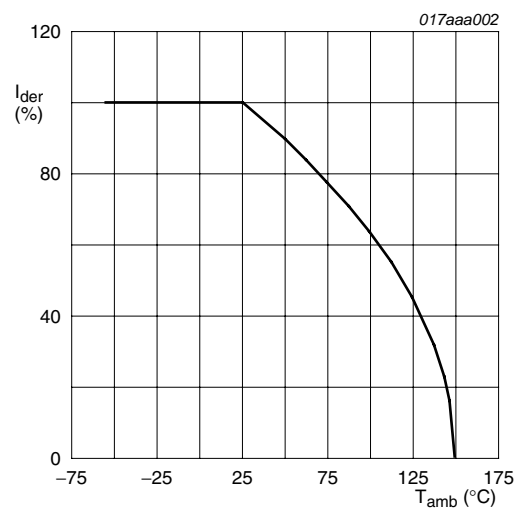
[1] Device mounted on an FR4 PCB, single-sided copper, tin-plated, mounting pad for drain 1 cm<sup>2</sup>.

[2] Device mounted on an FR4 PCB, single-sided copper, tin-plated and standard footprint.



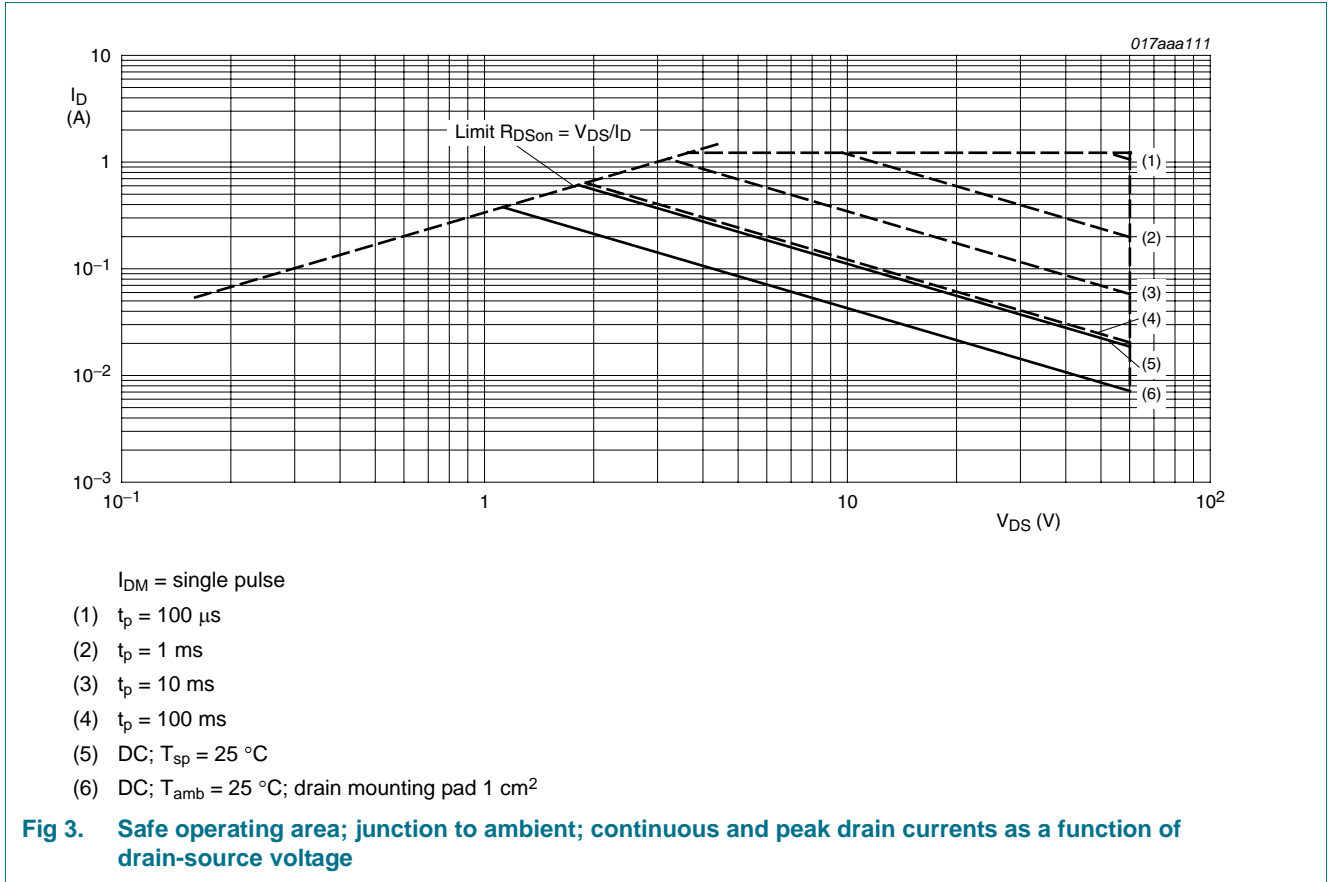
$$P_{der} = \frac{P_{tot}}{P_{tot(25^{\circ}C)}} \times 100\%$$

**Fig 1. Normalized total power dissipation as a function of ambient temperature**



$$I_{der} = \frac{I_D}{I_{D(25^{\circ}C)}} \times 100\%$$

**Fig 2. Normalized continuous drain current as a function of ambient temperature**



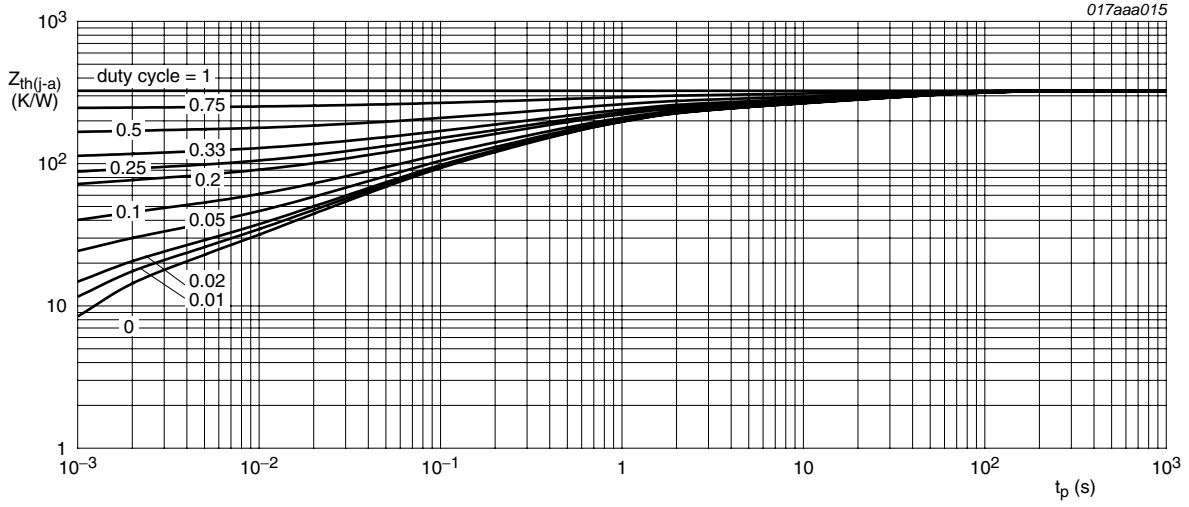
## 6. Thermal characteristics

**Table 6. Thermal characteristics**

| Symbol         | Parameter  | Conditions  | Min | Typ | Max | Unit |     |
|----------------|--|-------------|-----|-----|-----|------|-----|
| $R_{th(j-a)}$  | thermal resistance from junction to ambient      | in free air | [1] | -   | 310 | 370  | K/W |
|                |  |             | [2] | -   | 260 | 300  | K/W |
| $R_{th(j-sp)}$ | thermal resistance from junction to solder point |             | -   | -   | 115 | K/W  |     |

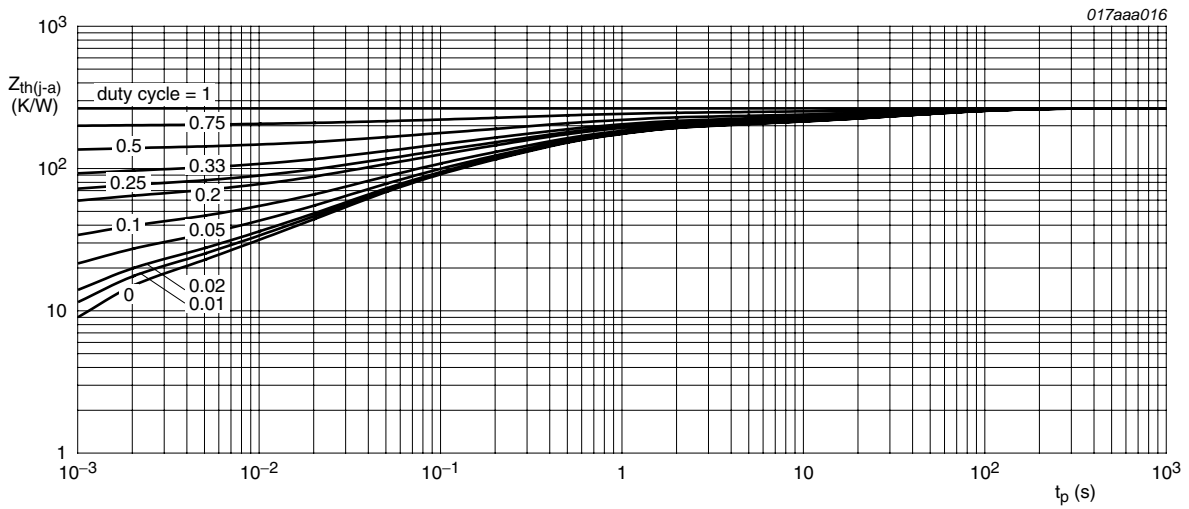
[1] Device mounted on an FR4 PCB, single-sided copper, tin-plated and standard footprint.

[2] Device mounted on an FR4 PCB, single-sided copper, tin-plated, mounting pad for drain  $1 \text{ cm}^2$ .



FR4 PCB, standard footprint

Fig 4. Transient thermal impedance from junction to ambient as a function of pulse duration; typical values



FR4 PCB, mounting pad for drain 1 cm<sup>2</sup>

Fig 5. Transient thermal impedance from junction to ambient as a function of pulse duration; typical values

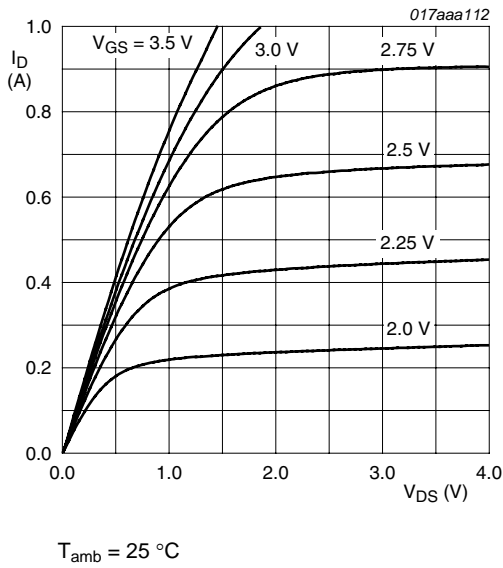
## 7. Characteristics

**Table 7. Characteristics**

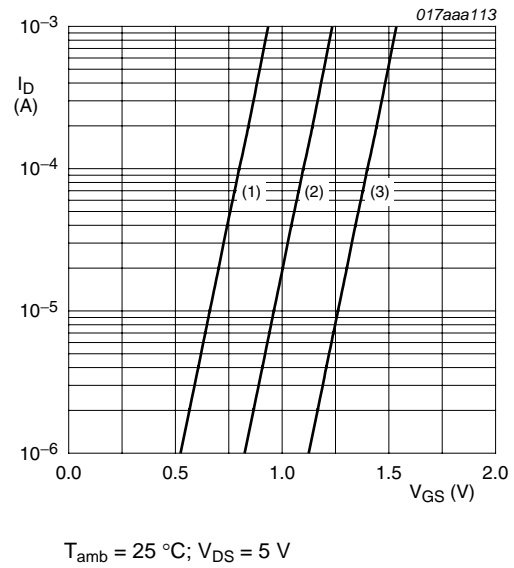
$T_j = 25\text{ °C}$  unless otherwise specified.

| Symbol                         | Parameter                        | Conditions  | Min  | Typ  | Max | Unit          |
|--------------------------------|----------------------------------|---|------|------|-----|---------------|
| <b>Static characteristics</b>  |                                  |   |      |      |     |               |
| $V_{(BR)DSS}$                  | drain-source breakdown voltage   | $I_D = 10\ \mu\text{A}; V_{GS} = 0\ \text{V}$   | 60   | -    | -   | V             |
| $V_{GS(th)}$                   | gate-source threshold voltage    | $I_D = 250\ \mu\text{A}; V_{DS} = V_{GS}$   | 0.9  | 1.2  | 1.5 | V             |
| $I_{DSS}$                      | drain leakage current            | $V_{DS} = 60\ \text{V}; V_{GS} = 0\ \text{V}$   |      |      |     |               |
|                                |                                  | $T_j = 25\text{ °C}$  | -    | -    | 1   | $\mu\text{A}$ |
|                                |                                  | $T_j = 150\text{ °C}$   | -    | -    | 10  | $\mu\text{A}$ |
| $I_{GSS}$                      | gate leakage current             | $V_{GS} = \pm 20\ \text{V}; V_{DS} = 0\ \text{V}$   | -    | -    | 100 | nA            |
| $R_{DS(on)}$                   | drain-source on-state resistance |   | [1]  |      |     |               |
|                                |                                  | $V_{GS} = 5\ \text{V}; I_D = 50\ \text{mA}$   | -    | 1    | 2   | $\Omega$      |
|                                |                                  | $V_{GS} = 10\ \text{V}; I_D = 300\ \text{mA}$   | -    | 0.9  | 1.6 | $\Omega$      |
| $g_{fs}$                       | forward transconductance         | $V_{DS} = 10\ \text{V}; I_D = 200\ \text{mA}$   | [1]  | -    | 700 | mS            |
| <b>Dynamic characteristics</b> |                                  |   |      |      |     |               |
| $Q_{G(tot)}$                   | total gate charge                | $I_D = 300\ \text{mA};$<br>$V_{DS} = 30\ \text{V};$<br>$V_{GS} = 4.5\ \text{V}$                   | -    | 0.72 | 0.8 | nC            |
| $Q_{GS}$                       | gate-source charge               |   | -    | 0.14 | -   | nC            |
| $Q_{GD}$                       | gate-drain charge                |   | -    | 0.24 | -   | nC            |
| $C_{iss}$                      | input capacitance                | $V_{GS} = 0\ \text{V}; V_{DS} = 10\ \text{V};$<br>$f = 1\ \text{MHz}$                             | -    | 38   | 50  | pF            |
| $C_{oss}$                      | output capacitance               |   | -    | 7    | -   | pF            |
| $C_{rss}$                      | reverse transfer capacitance     |   | -    | 4    | -   | pF            |
| $t_{d(on)}$                    | turn-on delay time               | $V_{DS} = 50\ \text{V};$<br>$R_L = 250\ \Omega;$<br>$V_{GS} = 10\ \text{V};$<br>$R_G = 6\ \Omega$ | -    | 2    | 6   | ns            |
| $t_r$                          | rise time                        |   | -    | 3    | -   | ns            |
| $t_{d(off)}$                   | turn-off delay time              |   | -    | 9    | 20  | ns            |
| $t_f$                          | fall time                        |   | -    | 4    | -   | ns            |
| <b>Source-drain diode</b>      |                                  |   |      |      |     |               |
| $V_{SD}$                       | source-drain voltage             | $I_S = 115\ \text{mA}; V_{GS} = 0\ \text{V}$  | 0.47 | 0.75 | 1.1 | V             |

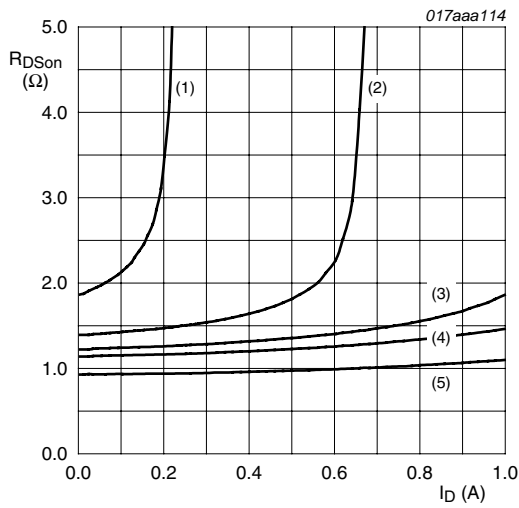
[1] Pulse test:  $t_p \leq 300\ \mu\text{s}; \delta \leq 0.01$ .



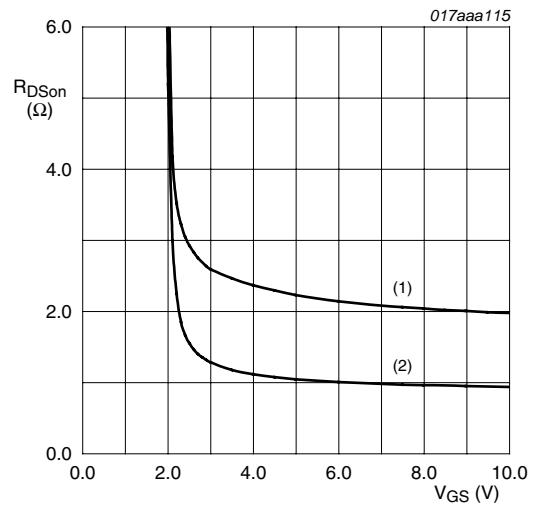
**Fig 6. Output characteristics: drain current as a function of drain-source voltage; typical values**



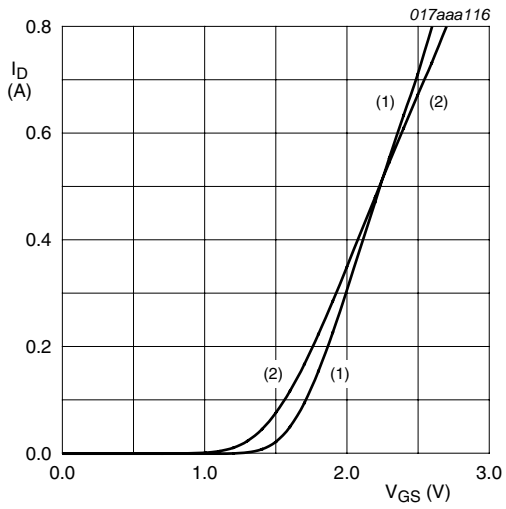
**Fig 7. Sub-threshold drain current as a function of gate-source voltage**



**Fig 8. Drain-source on-state resistance as a function of drain current; typical values**

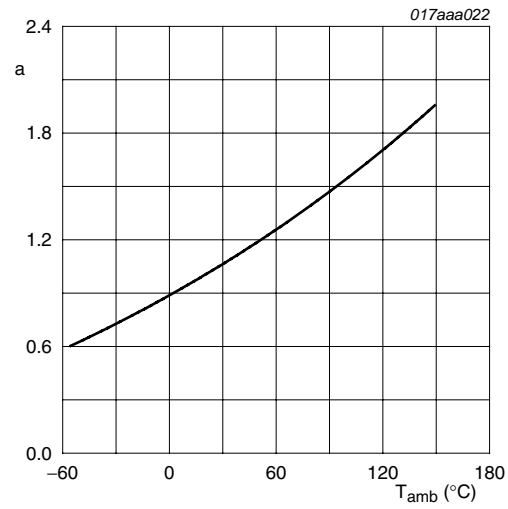


**Fig 9. Drain-source on-state resistance as a function of gate-source voltage; typical values**



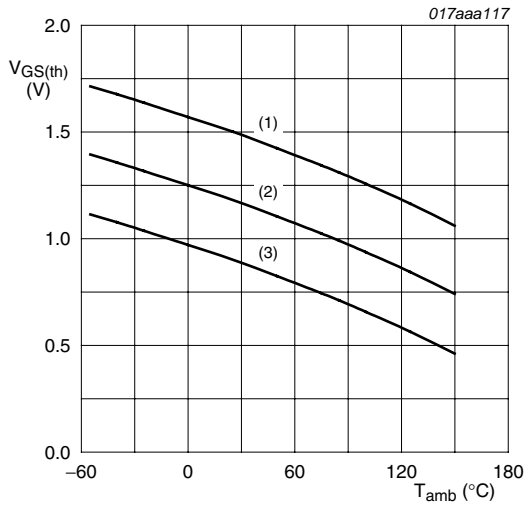
$V_{DS} > I_D \times R_{DSon}$   
 (1)  $T_{amb} = 25\text{ }^\circ\text{C}$   
 (2)  $T_{amb} = 150\text{ }^\circ\text{C}$

**Fig 10. Transfer characteristics: drain current as a function of gate-source voltage; typical values**



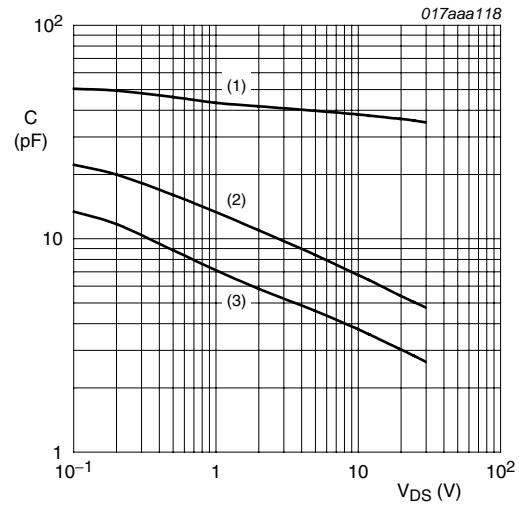
$$a = \frac{R_{DSon}}{R_{DSon(25^\circ\text{C})}}$$

**Fig 11. Normalized drain-source on-state resistance as a function of ambient temperature; typical values**



$I_D = 0.25\text{ mA}; V_{DS} = V_{GS}$   
 (1) maximum values  
 (2) typical values  
 (3) minimum values

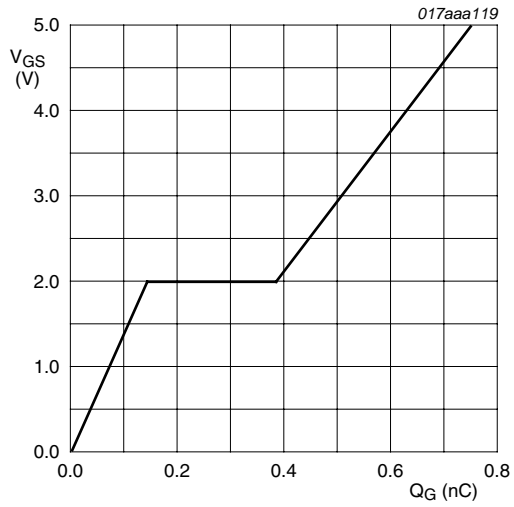
**Fig 12. Gate-source threshold voltage as a function of ambient temperature**



$f = 1\text{ MHz}; V_{GS} = 0\text{ V}$   
 (1)  $C_{iss}$   
 (2)  $C_{oss}$   
 (3)  $C_{rss}$

**Fig 13. Input, output and reverse transfer capacitances as a function of drain-source voltage; typical values**



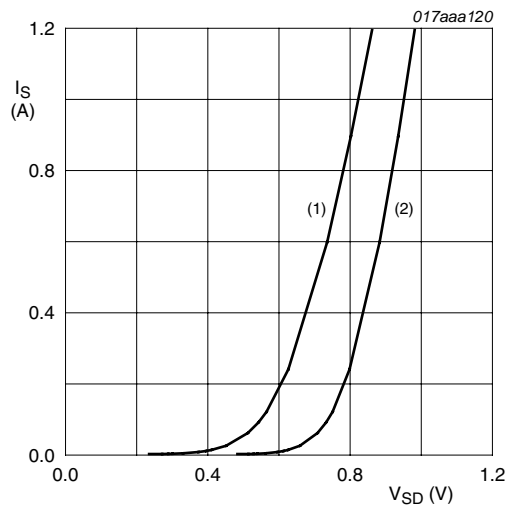


$I_D = 300 \text{ mA}$ ;  $V_{DS} = 30 \text{ V}$ ;  $T_{amb} = 25 \text{ }^\circ\text{C}$

**Fig 14. Gate-source voltage as a function of gate charge; typical values**



**Fig 15. Gate charge waveform definitions**

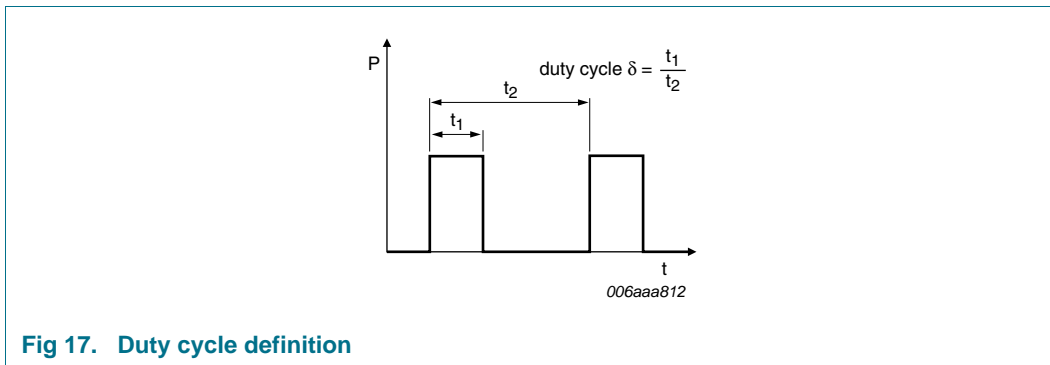


$V_{GS} = 0 \text{ V}$

- (1)  $T_{amb} = 150 \text{ }^\circ\text{C}$
- (2)  $T_{amb} = 25 \text{ }^\circ\text{C}$

**Fig 16. Source current as a function of source-drain voltage; typical values**

## 8. Test information



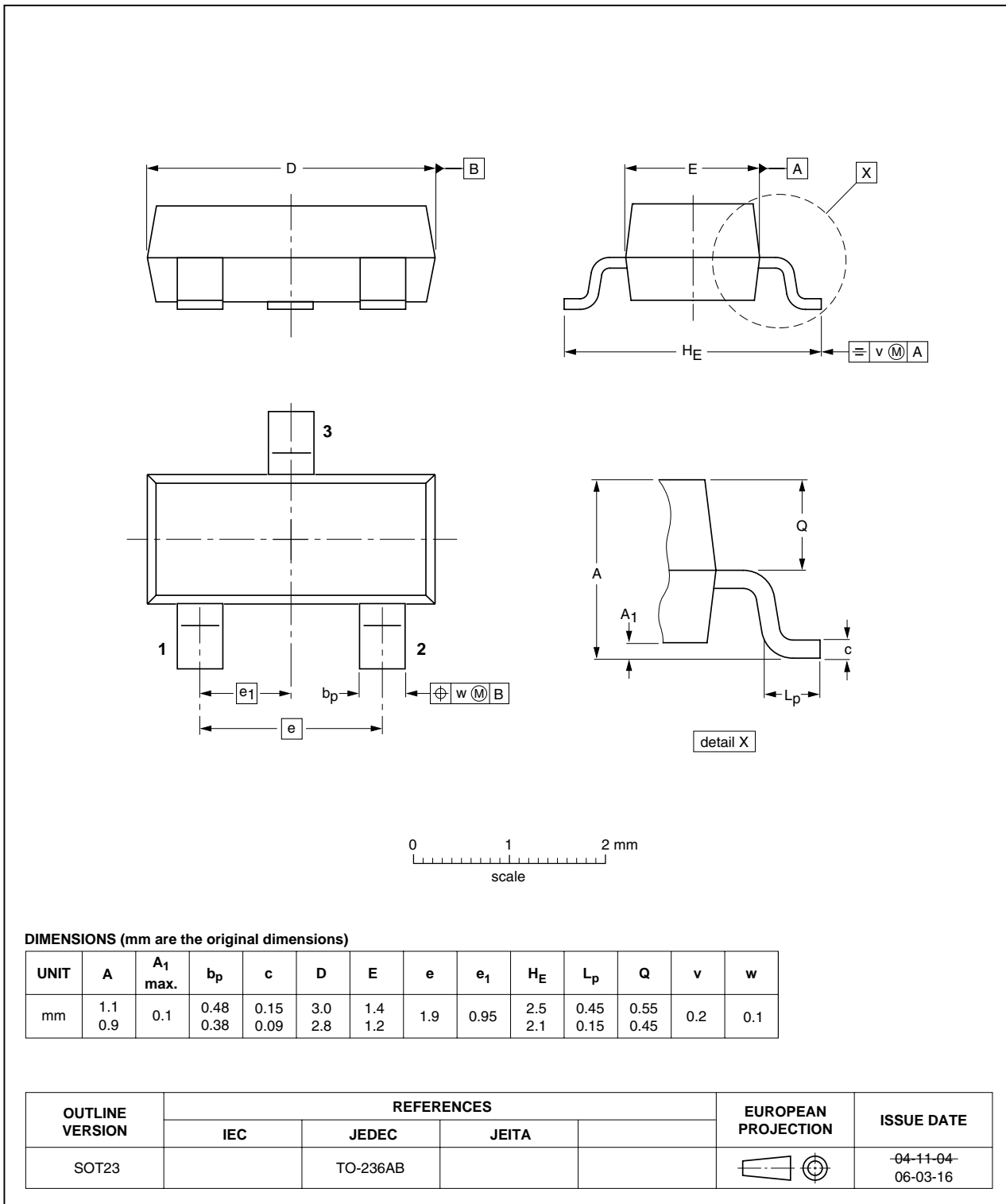
### 8.1 Quality information

This product has been qualified in accordance with the Automotive Electronics Council (AEC) standard Q101 - *Stress test qualification for discrete semiconductors*, and is suitable for use in automotive applications.

**9. Package outline**

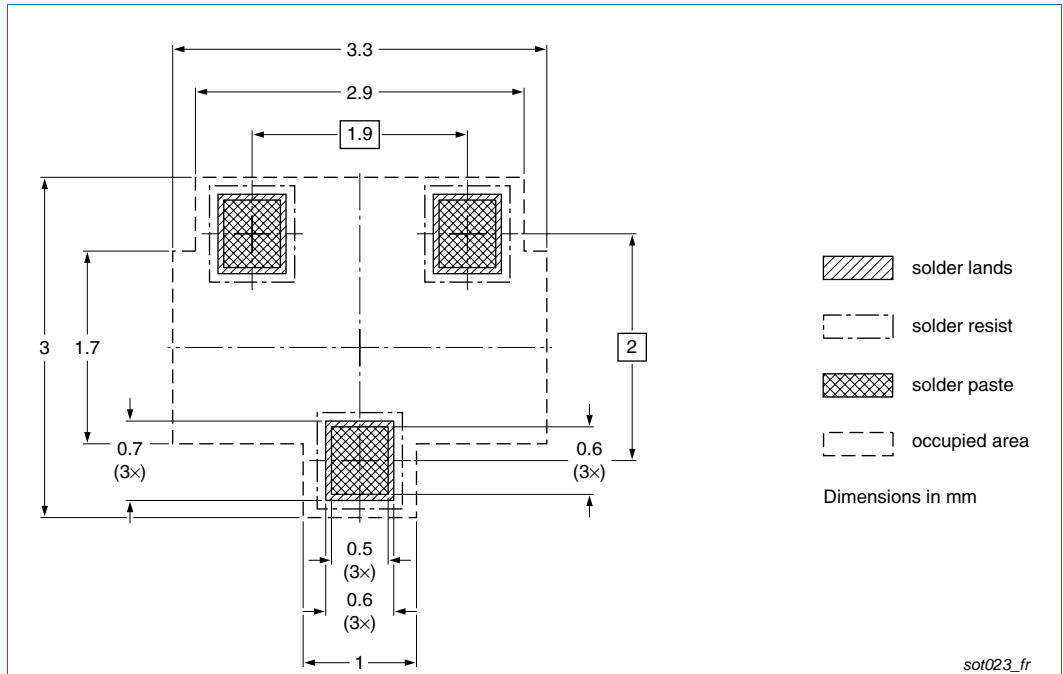
Plastic surface-mounted package; 3 leads

SOT23

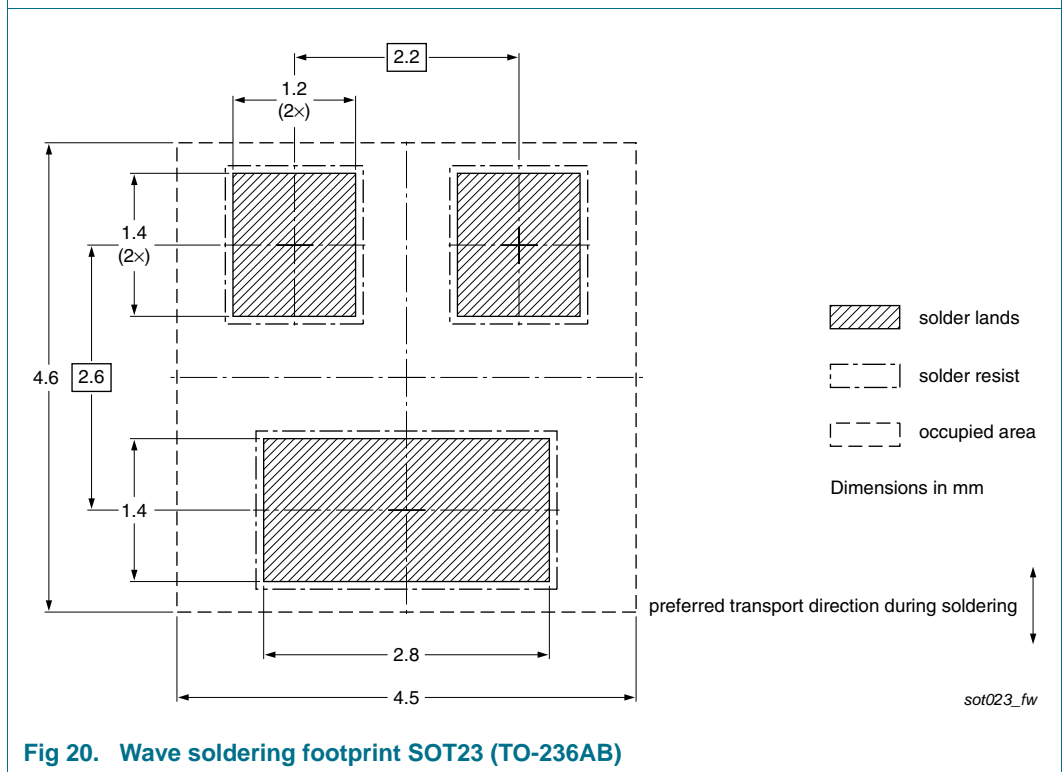


**Fig 18. Package outline SOT23 (TO-236AB)**

**10. Soldering**



**Fig 19. Reflow soldering footprint SOT23 (TO-236AB)**



**Fig 20. Wave soldering footprint SOT23 (TO-236AB)**

## 11. Revision history

Table 8. Revision history

| Document ID | Release date | Data sheet status  | Change notice | Supersedes |
|-------------|--------------|--------------------|---------------|------------|
| BSS138P v.1 | 20101102     | Product data sheet | -             | -          |

## 12. Legal information

### 12.1 Data sheet status

| Document status <sup>[1][2]</sup> | Product status <sup>[3]</sup> | Definition  |
|-----------------------------------|-------------------------------|---|
| Objective [short] data sheet      | Development                   | This document contains data from the objective specification for product development. |
| Preliminary [short] data sheet    | Qualification                 | This document contains data from the preliminary specification.                       |
| Product [short] data sheet        | Production                    | This document contains the product specification.                                     |

[1] Please consult the most recently issued document before initiating or completing a design.

[2] The term 'short data sheet' is explained in section "Definitions".

[3] The product status of device(s) described in this document may have changed since this document was published and may differ in case of multiple devices. The latest product status information is available on the Internet at URL <http://www.nexperia.com>.

### 12.2 Definitions

**Draft** — The document is a draft version only. The content is still under internal review and subject to formal approval, which may result in modifications or additions. Nexperia does not give any representations or warranties as to the accuracy or completeness of information included herein and shall have no liability for the consequences of use of such information.

**Short data sheet** — A short data sheet is an extract from a full data sheet with the same product type number(s) and title. A short data sheet is intended for quick reference only and should not be relied upon to contain detailed and full information. For detailed and full information see the relevant full data sheet, which is available on request via the local Nexperia sales office. In case of any inconsistency or conflict with the short data sheet, the full data sheet shall prevail.

**Product specification** — The information and data provided in a Product data sheet shall define the specification of the product as agreed between Nexperia and its customer, unless Nexperia and customer have explicitly agreed otherwise in writing. In no event however, shall an agreement be valid in which the Nexperia product is deemed to offer functions and qualities beyond those described in the Product data sheet.

### 12.3 Disclaimers

**Limited warranty and liability** — Information in this document is believed to be accurate and reliable. However, Nexperia does not give any representations or warranties, expressed or implied, as to the accuracy or completeness of such information and shall have no liability for the consequences of use of such information.

In no event shall Nexperia be liable for any indirect, incidental, punitive, special or consequential damages (including - without limitation - lost profits, lost savings, business interruption, costs related to the removal or replacement of any products or rework charges) whether or not such damages are based on tort (including negligence), warranty, breach of contract or any other legal theory.

Notwithstanding any damages that customer might incur for any reason whatsoever, Nexperia's aggregate and cumulative liability towards customer for the products described herein shall be limited in accordance with the *Terms and conditions of commercial sale* of Nexperia.

**Right to make changes** — Nexperia reserves the right to make changes to information published in this document, including without limitation specifications and product descriptions, at any time and without notice. This document supersedes and replaces all information supplied prior to the publication hereof.

**Suitability for use** — Nexperia products are not designed, authorized or warranted to be suitable for use in life support, life-critical or safety-critical systems or equipment, nor in applications where failure or

malfunction of a Nexperia product can reasonably be expected to result in personal injury, death or severe property or environmental damage. Nexperia accepts no liability for inclusion and/or use of Nexperia products in such equipment or applications and therefore such inclusion and/or use is at the customer's own risk.

**Applications** — Applications that are described herein for any of these products are for illustrative purposes only. Nexperia makes no representation or warranty that such applications will be suitable for the specified use without further testing or modification.

Customers are responsible for the design and operation of their applications and products using Nexperia products, and Nexperia accepts no liability for any assistance with applications or customer product design. It is customer's sole responsibility to determine whether the Nexperia product is suitable and fit for the customer's applications and products planned, as well as for the planned application and use of customer's third party customer(s). Customers should provide appropriate design and operating safeguards to minimize the risks associated with their applications and products.

Nexperia does not accept any liability related to any default, damage, costs or problem which is based on any weakness or default in the customer's applications or products, or the application or use by customer's third party customer(s). Customer is responsible for doing all necessary testing for the customer's applications and products using Nexperia products in order to avoid a default of the applications and the products or of the application or use by customer's third party customer(s). Nexperia does not accept any liability in this respect.

**Limiting values** — Stress above one or more limiting values (as defined in the Absolute Maximum Ratings System of IEC 60134) will cause permanent damage to the device. Limiting values are stress ratings only and (proper) operation of the device at these or any other conditions above those given in the Recommended operating conditions section (if present) or the Characteristics sections of this document is not warranted. Constant or repeated exposure to limiting values will permanently and irreversibly affect the quality and reliability of the device.

**Terms and conditions of commercial sale** — Nexperia products are sold subject to the general terms and conditions of commercial sale, as published at <http://www.nexperia.com/profile/terms>, unless otherwise agreed in a valid written individual agreement. In case an individual agreement is concluded only the terms and conditions of the respective agreement shall apply. Nexperia hereby expressly objects to applying the customer's general terms and conditions with regard to the purchase of Nexperia products by customer.

**No offer to sell or license** — Nothing in this document may be interpreted or construed as an offer to sell products that is open for acceptance or the grant, conveyance or implication of any license under any copyrights, patents or other industrial or intellectual property rights.

**Export control** — This document as well as the item(s) described herein may be subject to export control regulations. Export might require a prior authorization from national authorities.

**Quick reference data** — The Quick reference data is an extract of the product data given in the Limiting values and Characteristics sections of this document, and as such is not complete, exhaustive or legally binding.

## 12.4 Trademarks

Notice: All referenced brands, product names, service names and trademarks are the property of their respective owners.

## 13. Contact information

---

For more information, please visit: <http://www.nexperia.com>

For sales office addresses, please send an email to: [salesaddresses@nexperia.com](mailto:salesaddresses@nexperia.com)

## 14. Contents

---

|           |  |           |
|-----------|--|-----------|
| <b>1</b>  | <b>Product profile</b> . . . . .         | <b>1</b>  |
| 1.1       | General description . . . . .            | 1         |
| 1.2       | Features and benefits . . . . .          | 1         |
| 1.3       | Applications . . . . .                   | 1         |
| 1.4       | Quick reference data . . . . .           | 1         |
| <b>2</b>  | <b>Pinning information</b> . . . . .     | <b>2</b>  |
| <b>3</b>  | <b>Ordering information</b> . . . . .    | <b>2</b>  |
| <b>4</b>  | <b>Marking</b> . . . . .                 | <b>2</b>  |
| <b>5</b>  | <b>Limiting values</b> . . . . .         | <b>2</b>  |
| <b>6</b>  | <b>Thermal characteristics</b> . . . . . | <b>4</b>  |
| <b>7</b>  | <b>Characteristics</b> . . . . .         | <b>6</b>  |
| <b>8</b>  | <b>Test information</b> . . . . .        | <b>10</b> |
| 8.1       | Quality information . . . . .            | 10        |
| <b>9</b>  | <b>Package outline</b> . . . . .         | <b>11</b> |
| <b>10</b> | <b>Soldering</b> . . . . .               | <b>12</b> |
| <b>11</b> | <b>Revision history</b> . . . . .        | <b>13</b> |
| <b>12</b> | <b>Legal information</b> . . . . .       | <b>14</b> |
| 12.1      | Data sheet status . . . . .              | 14        |
| 12.2      | Definitions . . . . .                    | 14        |
| 12.3      | Disclaimers . . . . .                    | 14        |
| 12.4      | Trademarks . . . . .                     | 15        |
| <b>13</b> | <b>Contact information</b> . . . . .     | <b>15</b> |
| <b>14</b> | <b>Contents</b> . . . . .                | <b>16</b> |