

CAT3614

4-Channel 1-Wire LED Driver in 3 x 3 mm Package

Description

The CAT3614 is a high efficiency 1x/1.5x fractional charge pump with programmable dimming current in four LED channels. To ensure uniform brightness in LCD backlight applications, each LED channel delivers an accurate regulated current.

Low noise and input ripple is achieved by operating at a constant switching frequency of 1 MHz which allows the use of small external ceramic capacitors. The 1x/1.5x fractional charge pump supports a wide range of input voltages from 3 V to 5.5 V with efficiency up to 91%, and is ideal for Li-Ion battery powered devices.

The EN/DIM logic input provides a 1-wire EZDim™ interface for dimming control of the LEDs. When enabled, a series of clock pulses reduces the LED brightness in 1 mA steps on each negative going edge. Currents from 0 mA to 31 mA are supported.

The device is available in the tiny 12-pad TDFN 3 x 3 mm package with a max height of 0.8 mm.

Features

- Drives up to 4 LED Channels
- 1-wire EZDim™ Programmable LED Current
- Accurate 1 mA Dimming Level
- Power Efficiency up to 91%
- Fractional Pump 1x/1.5x
- Low Noise Input Ripple
- Fixed High Frequency Operation 1 MHz
- “Zero” Current Shutdown Mode
- Soft Start and Current Limiting
- Short Circuit Protection
- Thermal Shutdown Protection
- TDFN 12-pad 3 mm x 3 mm Package
- These Devices are Pb-Free, Halogen Free/BFR Free and are RoHS Compliant

Applications

- LCD Display Backlight
- Cellular Phones
- Digital Still Cameras
- Handheld Devices



ON Semiconductor®

<http://onsemi.com>



TDFN-12
HV2 SUFFIX
CASE 511AN

PIN CONNECTIONS

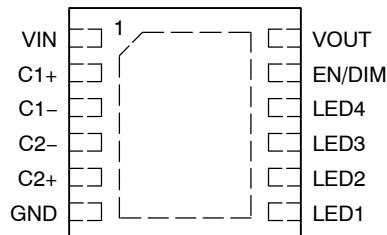

(Top View)

MARKING DIAGRAM



HAAA = CAT3614HV2-T2

HAAC = CAT3614HV2-GT2

A = Assembly Location

XXX = Last Three Digits of Assembly Lot Number

Y = Production Year (Last Digit)

WW = Production Week (Two Digit)

ORDERING INFORMATION

Device	Package	Shipping
CAT3614HV2-T2 (Note 1)	TDFN-12 (Pb-Free)	2,000/ Tape & Reel
CAT3614HV2-GT2 (Note 2)	TDFN-12 (Pb-Free)	2,000/ Tape & Reel

1. Matte-Tin Plated Finish (RoHS-compliant).
2. NiPdAu Plated Finish (RoHS-compliant).

CAT3614

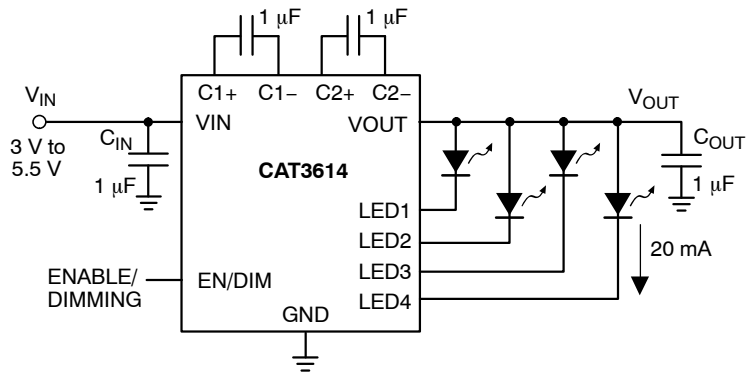

Figure 1. Typical Application Circuit

NOTE: Unused LED channels must be connected to VOUT.

Table 1. ABSOLUTE MAXIMUM RATINGS

Parameter	Rating	Unit
V _{IN} , LED _x voltage	6	V
V _{OUT} , C _{1±} , C _{2±} voltage	7	V
EN/DIM voltage	V _{IN} + 0.7 V	V
Storage Temperature Range	-65 to +160	°C
Junction Temperature Range	-40 to +150	°C
Lead Temperature	300	°C

Stresses exceeding Maximum Ratings may damage the device. Maximum Ratings are stress ratings only. Functional operation above the Recommended Operating Conditions is not implied. Extended exposure to stresses above the Recommended Operating Conditions may affect device reliability.

Table 2. RECOMMENDED OPERATING CONDITIONS

Parameter	Range	Unit
V _{IN}	3 to 5.5	V
Ambient Temperature Range	-40 to +85	°C
I _{LED} per LED pin	0 to 31	mA
Total Output Current	0 to 124	mA

NOTE: Typical application circuit with external components is shown above.

CAT3614

Table 3. ELECTRICAL OPERATING CHARACTERISTICS

$V_{IN} = 3.6\text{ V}$, EN = High, ambient temperature of 25°C (over recommended operating conditions unless specified otherwise).

Symbol	Parameter	Conditions	Min	Typ	Max	Unit
I_Q	Quiescent Current	1x mode, no load 1.5x mode, no load	0.3 1	0.5 3	1 8	mA
I_{QSHDN}	Shutdown Current	$V_{EN} = 0\text{ V}$			1	μA
$I_{LED-ACC}$	LED Current Accuracy	$1\text{ mA} \leq I_{LED} \leq 31\text{ mA}$		± 3	± 8	%
$I_{LED-DEV}$	LED Channel Matching	$(I_{LED} - I_{LEDAVG}) / I_{LEDAVG}$		± 3	± 7	%
R_{OUT}	Output Resistance (open loop)	1x mode, $I_{OUT} = 100\text{ mA}$ 1.5x mode, $I_{OUT} = 100\text{ mA}$		0.4 2.6	1 7	Ω
F_{OSC}	Charge Pump Frequency		0.8	1	1.3	MHz
I_{SC_MAX}	Output short circuit Current Limit	$V_{OUT} < 0.5\text{ V}$	30	60	100	mA
I_{IN_MAX}	Input Current Limit	1x mode, $V_{OUT} > 1\text{ V}$	200	300	600	mA
$I_{EN/DIM}$	EN/DIM Pin					
V_{HI}	- Input Leakage		-1		1	μA
V_{LO}	- Logic High Level		1.3			V
	- Logic Low Level				0.4	V
T_{SD}	Thermal Shutdown		145	165	175	$^{\circ}\text{C}$
T_{HYS}	Thermal Hysteresis		10	20	30	$^{\circ}\text{C}$
V_{UVLO}	Undervoltage lock out (UVLO) threshold		1.7	2	2.4	V

Table 4. RECOMMENDED EN/DIM TIMING (For $3\text{ V} \leq V_{IN} \leq 5.5\text{ V}$, over full ambient temperature range -40 to $+85^{\circ}\text{C}$.)

Symbol	Parameter	Conditions	Min	Typ	Max	Unit
T_{SETP}	EN/DIM setup from shutdown		10			μs
T_{LO}	EN/DIM program low time		0.3		200	μs
T_{HI}	EN/DIM program high time		0.3			μs
T_{OFF}	EN/DIM low time to shutdown		1.5			ms
T_D	LED current enable			40		μs
T_{DEC}	LED current decrement			0.1		μs

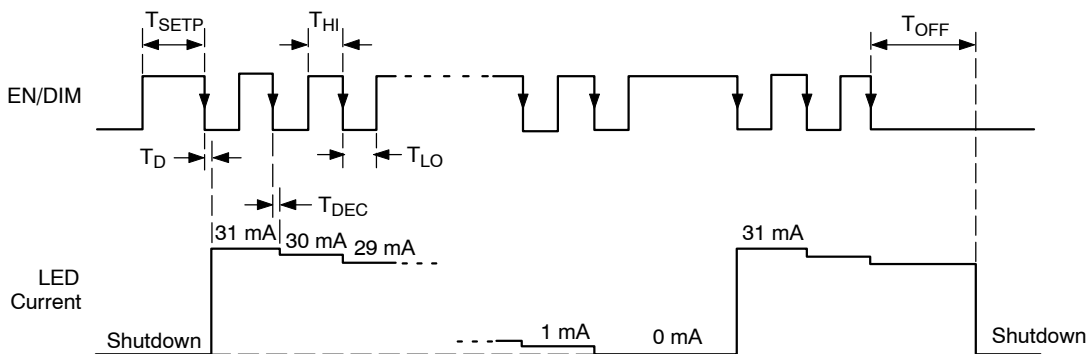

Figure 2. LED Dimming Timing Diagram

TYPICAL CHARACTERISTICS

($V_{IN} = 3.6\text{ V}$, $I_{OUT} = 80\text{ mA}$ (4 LEDs at 20 mA), $C_1 = C_2 = C_{IN} = C_{OUT} = 1\ \mu\text{F}$, $T_{AMB} = 25^\circ\text{C}$ unless otherwise specified.)

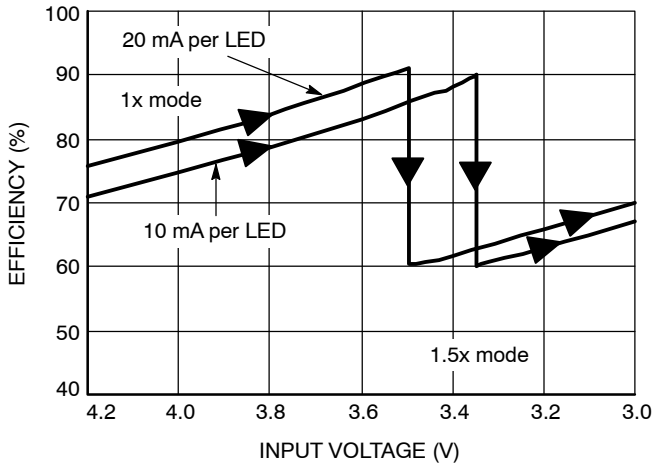

Figure 3. Efficiency vs. Input Voltage (4 LEDs)

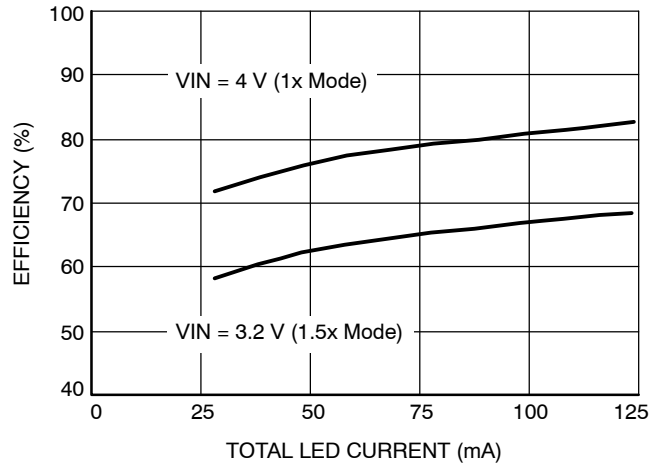

Figure 4. Efficiency vs. Total LED Current (4 LEDs)

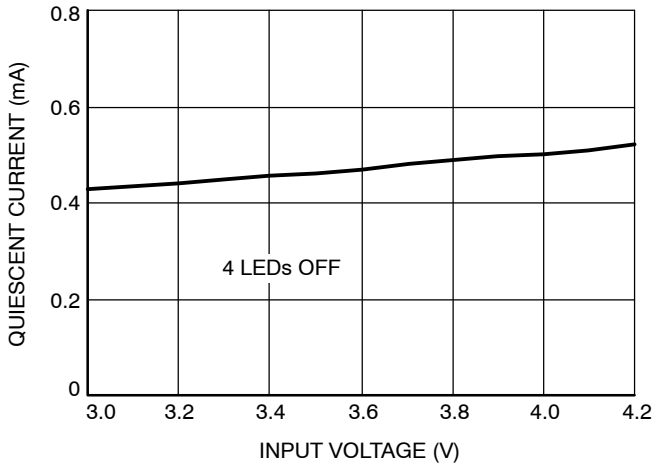

Figure 5. Quiescent Current vs. Input Voltage (1x Mode)

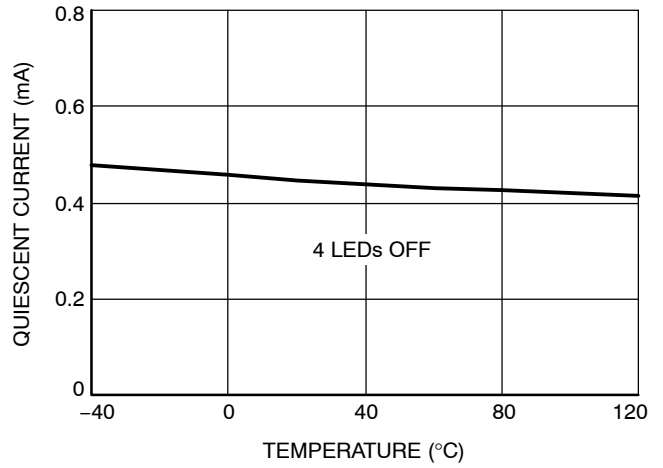

Figure 6. Quiescent Current vs. Temperature (1x Mode)

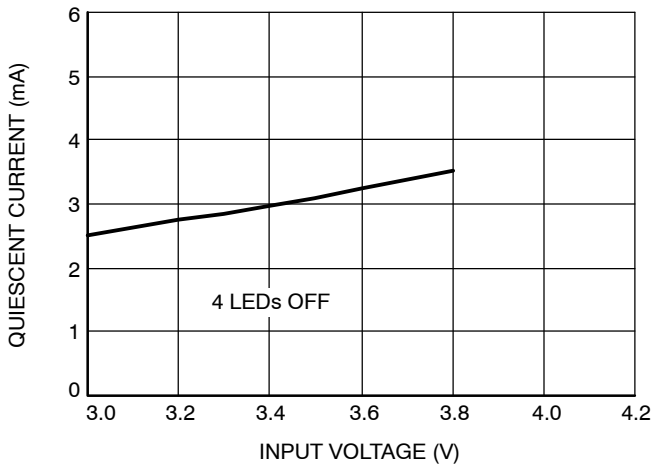

Figure 7. Quiescent Current vs. Input Voltage (1.5x Mode)

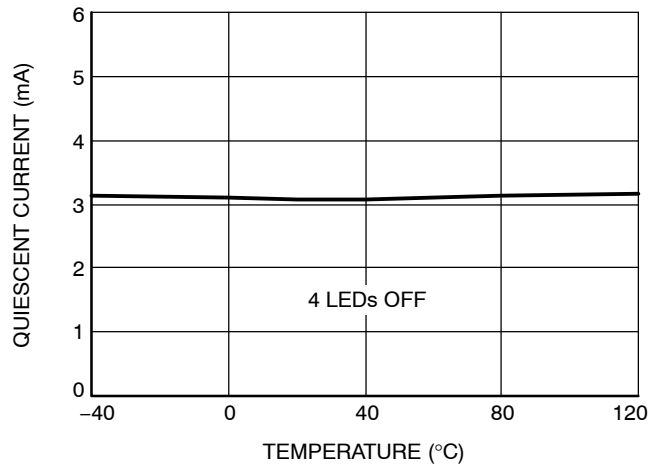

Figure 8. Quiescent Current vs. Temperature (1.5x Mode)

CAT3614

TYPICAL CHARACTERISTICS

($V_{IN} = 3.6\text{ V}$, $I_{OUT} = 80\text{ mA}$ (4 LEDs at 20 mA), $C_1 = C_2 = C_{IN} = C_{OUT} = 1\ \mu\text{F}$, $T_{AMB} = 25^\circ\text{C}$ unless otherwise specified.)

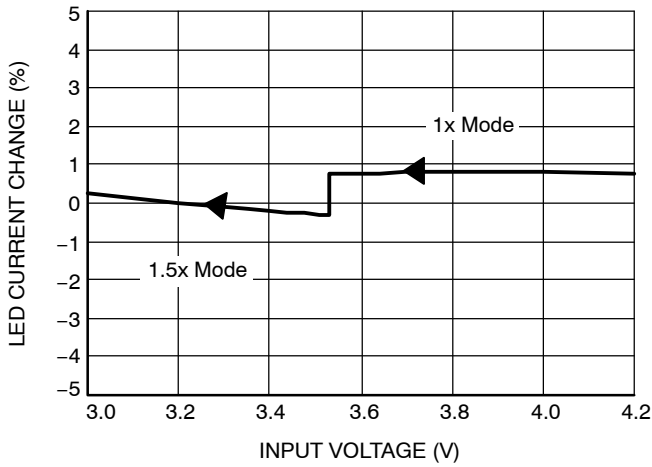

Figure 9. LED Current Change vs. Input Voltage

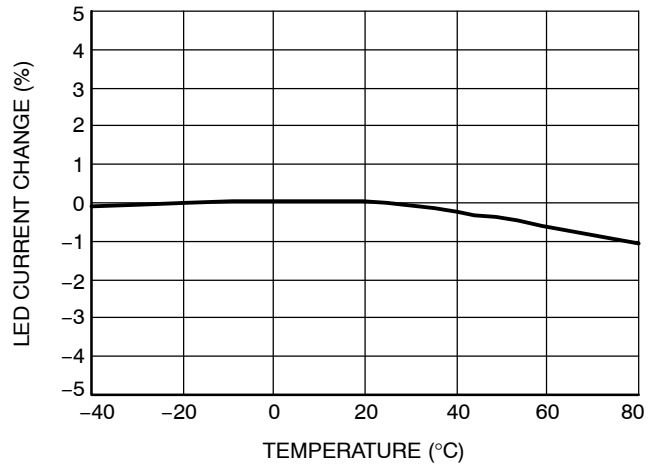

Figure 10. LED Current Change vs. Temperature

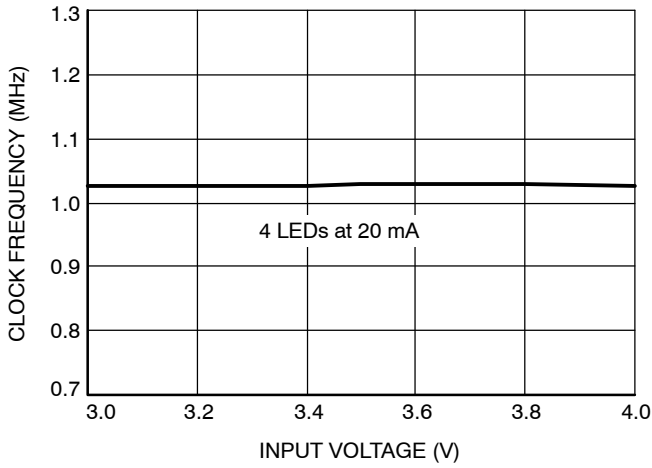

Figure 11. Oscillator Frequency vs. Input Voltage

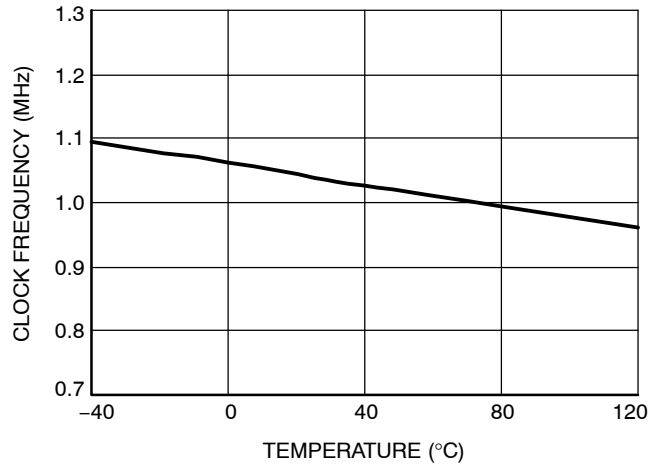

Figure 12. Oscillator Frequency vs. Temperature

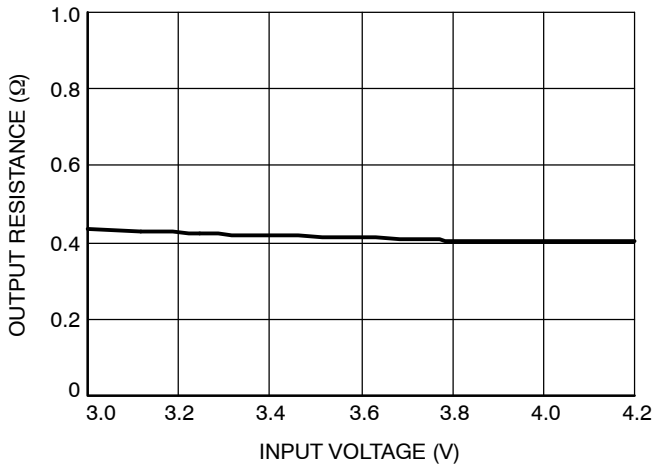

Figure 13. Output Resistance vs. Input Voltage (1x Mode)

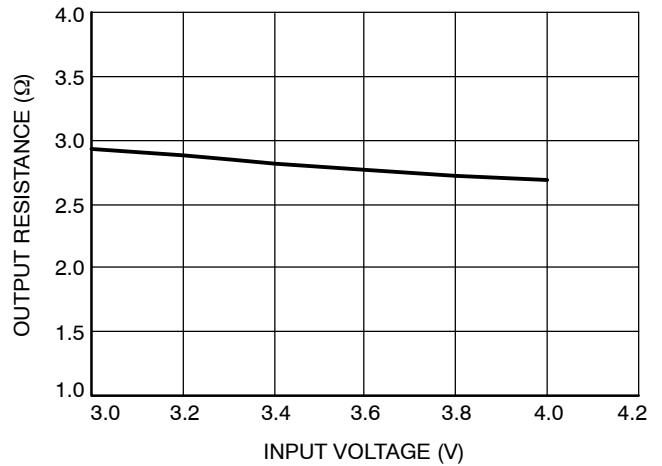

Figure 14. Output Resistance vs. Input Voltage (1.5x Mode)

CAT3614

TYPICAL CHARACTERISTICS

($V_{IN} = 3.6\text{ V}$, $I_{OUT} = 80\text{ mA}$ (4 LEDs at 20 mA), $C_1 = C_2 = C_{IN} = C_{OUT} = 1\text{ }\mu\text{F}$, $T_{AMB} = 25^\circ\text{C}$ unless otherwise specified.)

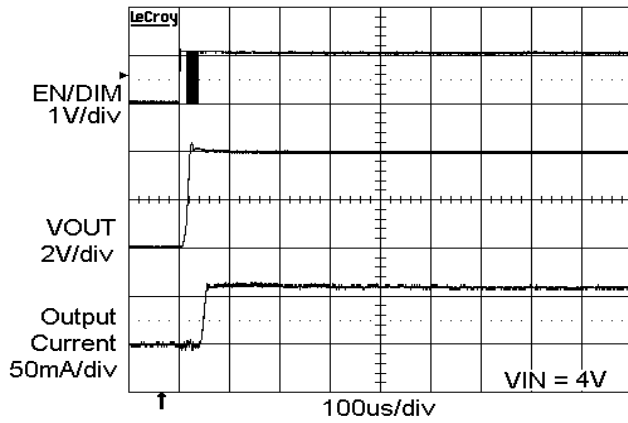

Figure 15. Power Up with 4 LEDs at 15 mA (1x Mode)

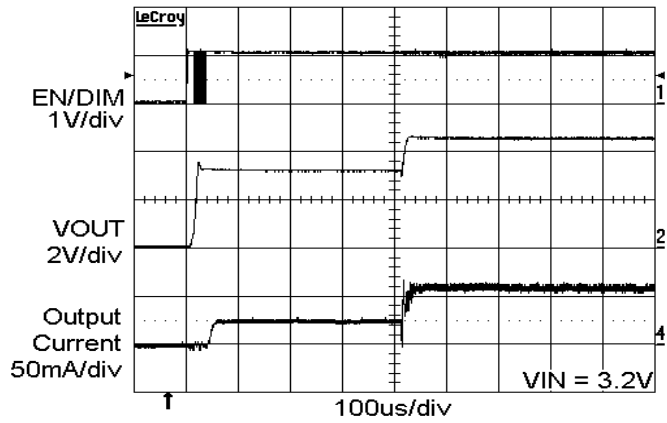

Figure 16. Power Up with 4 LEDs at 15 mA (1.5x Mode)

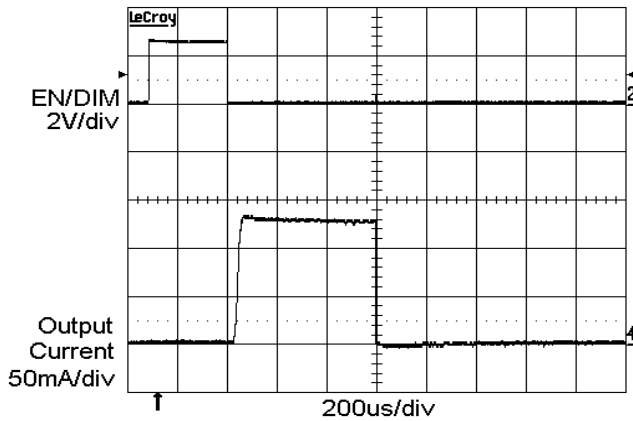

Figure 17. Enable Power Down Delay (1x Mode)

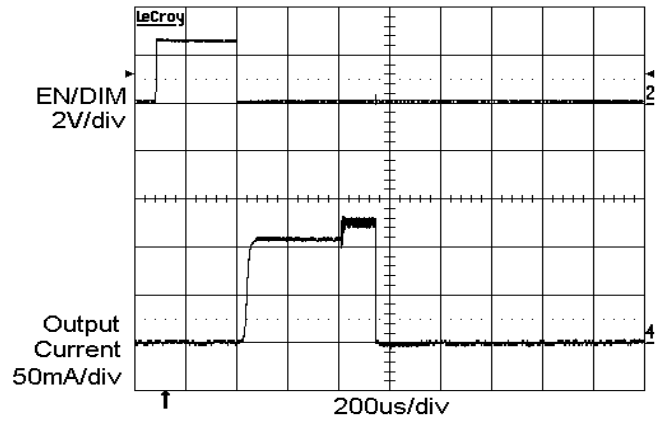

Figure 18. Enable Power Down Delay (1.5x Mode)

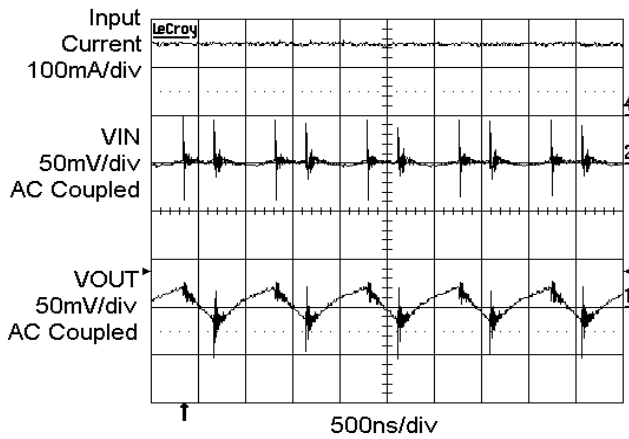

Figure 19. Switching Waveforms in 1.5x Mode

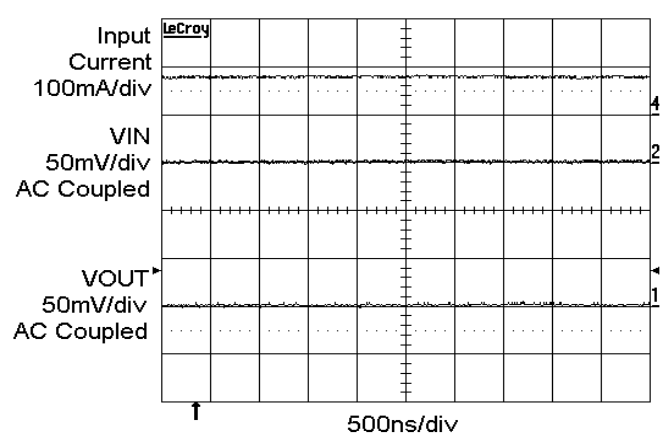

Figure 20. Operating Waveforms in 1x Mode

CAT3614

TYPICAL CHARACTERISTICS

($V_{IN} = 3.6\text{ V}$, $I_{OUT} = 80\text{ mA}$ (4 LEDs at 20 mA), $C_1 = C_2 = C_{IN} = C_{OUT} = 1\ \mu\text{F}$, $T_{AMB} = 25^\circ\text{C}$ unless otherwise specified.)

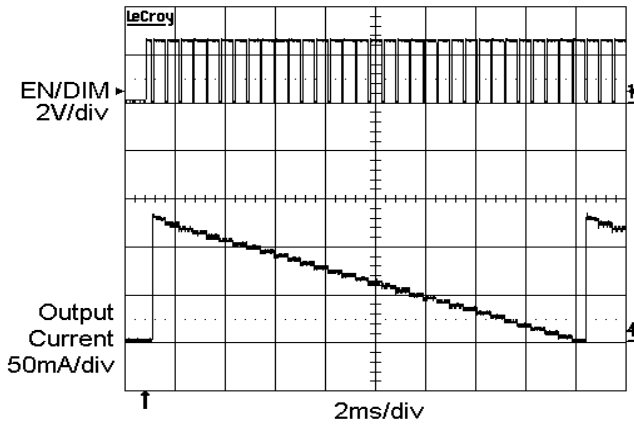

Figure 21. Enable and Output Current Dimming Waveforms

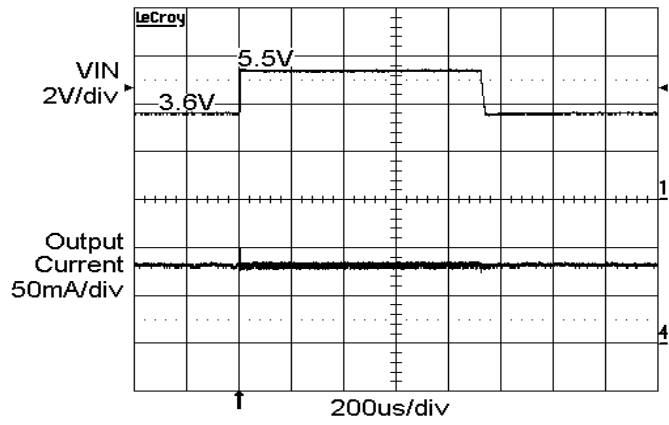

Figure 22. Line Transient Response (3.6 V to 5.5 V) 1x Mode

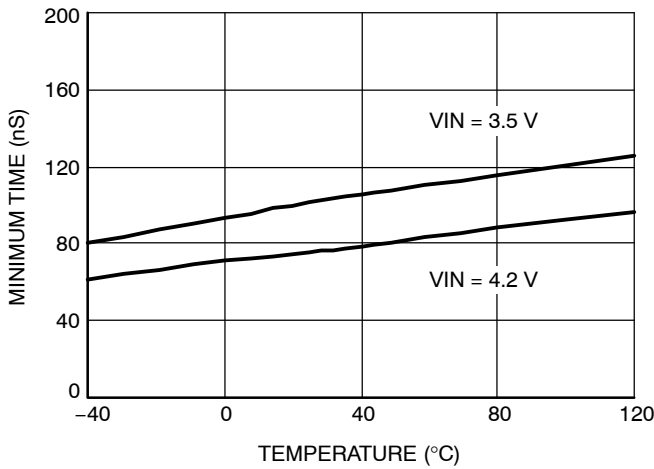

Figure 23. Enable High Minimum Program Time vs. Temperature

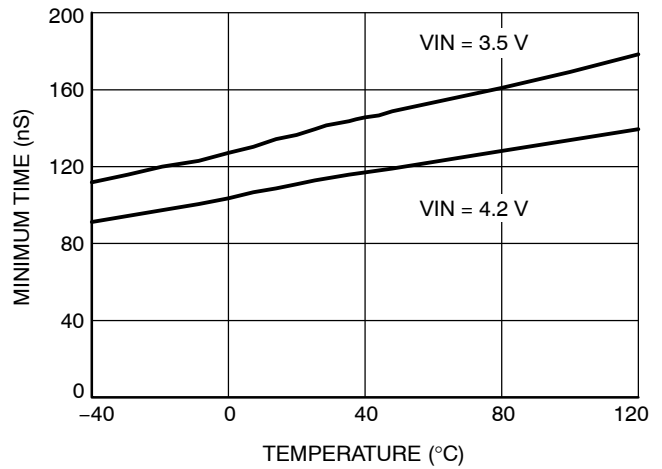

Figure 24. Enable Low Minimum Program Time vs. Temperature

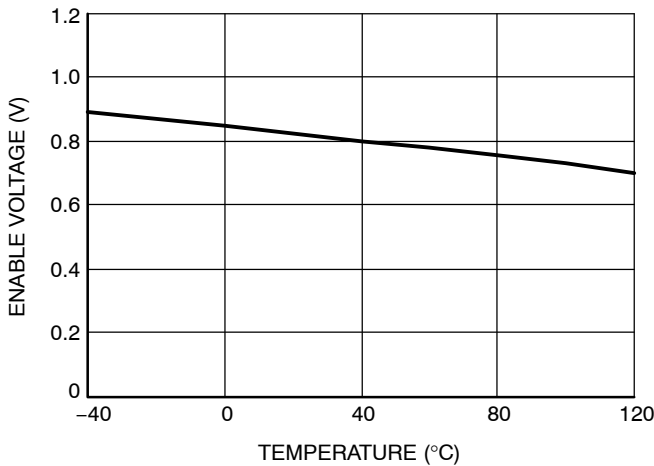

Figure 25. Enable Voltage Threshold vs. Temperature

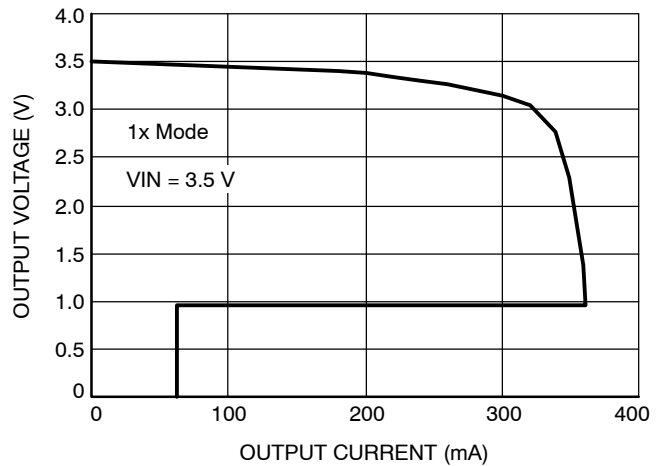

Figure 26. Foldback Current Limit

Table 5. PIN DESCRIPTIONS

Pin #	Name	Function
1	VIN	Supply voltage.
2	C1+	Bucket capacitor 1 terminal
3	C1-	Bucket capacitor 1 terminal
4	C2-	Bucket capacitor 2 terminal
5	C2+	Bucket capacitor 2 terminal
6	GND	Ground reference
7	LED1	LED1 cathode terminal (if not used, connect to VOUT) (Note 3)
8	LED2	LED2 cathode terminal (if not used, connect to VOUT) (Note 3)
9	LED3	LED3 cathode terminal (if not used, connect to VOUT) (Note 3)
10	LED4	LED4 cathode terminal (if not used, connect to VOUT) (Note 3)
11	EN/DIM	Device enable (active high) and dimming control input
12	VOUT	Charge pump output connected to the LED anodes
TAB	TAB	Connect to GND on the PCB

3. LED1, LED2, LED3, LED4 pins should not be left floating. They should be connected to the LED cathode, or tied to VOUT pin if not used.

Pin Function

VIN is the supply pin for the charge pump. A small 1 μ F ceramic bypass capacitor is required between the VIN pin and ground near the device. The operating input voltage range is from 2.2 V to 5.5 V. Whenever the input supply falls below the undervoltage threshold (2 V) all LEDs channels will be automatically disabled.

EN/DIM is the enable and dimming control logic input for all LED channels. Guaranteed levels of logic high and logic low are set at 1.3 V and 0.4 V respectively. When EN/DIM is initially taken high, the device becomes enabled and all LED currents remain at 0 mA. The falling edge of the first pulse applied to EN/DIM sets all LED currents to their full scale of 31 mA.

On each consecutive falling edge of the pulse applied to EN/DIM, the LED current is decreased by 1 mA step. On the 32nd pulse, the LED current is set to zero. The next pulse on EN/DIM resets the current back to their full scale of 31 mA.

To place the device into zero current shutdown mode, the EN/DIM pin must be held low for 1.5 ms or more.

VOUT is the charge pump output that is connected to the LED anodes. A small 1 μ F ceramic bypass capacitor is required between the VOUT pin and ground near the device.

GND is the ground reference for the charge pump. The pin must be connected to the ground plane on the PCB.

C1+, C1- are connected to each side of the 1 μ F ceramic bucket capacitor C1.

C2+, C2- are connected to each side of the 1 μ F ceramic bucket capacitor C2.

LED1 to LED4 provide the internal regulated current for each of the LED cathodes. These pins enter a high impedance zero current state whenever the device is placed in shutdown mode. In applications using less than four LEDs, all unused channels should be wired directly to VOUT. This ensures the channel is automatically disabled dissipating less than 200 μ A.

TAB is the exposed pad underneath the package. For best thermal performance, the tab should be soldered to the PCB and connected to the ground plane.

CAT3614

Block Diagram

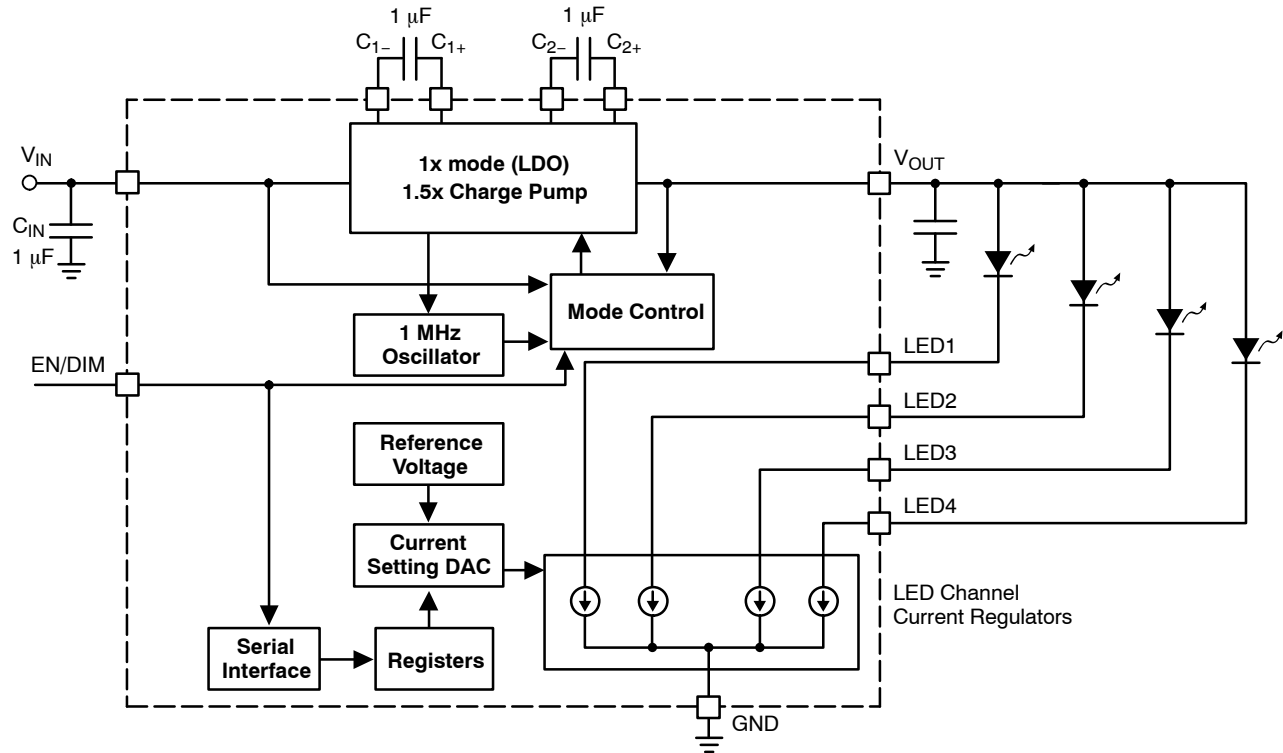

Figure 27. CAT3614 Functional Block Diagram

Basic Operation

At power-up, the CAT3614 starts operating in 1x mode where the output will be approximately equal to the input supply voltage (less any internal voltage losses). If the output voltage is sufficient to regulate all LED currents the device remains in 1x operating mode.

If the input voltage is insufficient or falls to a level where the regulated currents cannot be maintained, the device automatically switches (after a fixed delay of 400 μ s) into 1.5x mode.

In 1.5x mode, the output is approximately equal to 1.5 times the input supply voltage (less any internal voltage losses).

The above sequence is repeated each and every time the chip is powered-up or is taken out of shutdown mode (via EN/DIM pin).

LED Current Setting

Figure 2 shows the timing diagram necessary at the EN/DIM input for setting the LED currents.

The EN/DIM set up time requires the signal to be held high for 10 μ s or longer to ensure the initialization of the driver at power-up. Each subsequent pulse on the EN/DIM (300 ns to 200 μ s pulse duration) steps down the LED current from full scale of 31 mA to zero with a 1 mA resolution. Consecutive pulses should be separated by 300 ns or longer. Pulsing beyond the 0 mA level restores the current level back to full scale and the cycle repeats. Pulsing frequencies from 5 kHz up to 1 MHz can be supported during dimming operations. When the EN/DIM is held low for 1.5 ms or more, the CAT3614 enters the shutdown mode and draws “zero” current.

For applications with three LEDs or less, any unused LED pins should be tied to VOUT, as shown on Figure 28.

Protection Mode

If an LED becomes open-circuit, the output voltage VOUT is internally limited to about 5.5 V. This is to prevent the output pin from exceeding its absolute maximum rating.

The driver enters a thermal shutdown mode as soon as the die temperature exceeds about +165°C. When the device

temperature drops down by about 20°C, the device resumes normal operation.

External Components

The driver requires a total of four external 1 μ F ceramic capacitors: two for decoupling input and output, and two for the charge pump. Both capacitor types X5R and X7R are recommended for the LED driver application. In the 1.5x charge pump mode, the input current ripple is kept very low by design, and an input bypass capacitor of 1 μ F is sufficient. In 1x mode, the device operating in linear mode does not introduce switching noise back onto the supply.

Recommended Layout

In 1.5x charge pump mode, the driver switches internally at a high frequency of 1 MHz. It is recommended to minimize trace length to all four capacitors. A ground plane should cover the area under the driver IC as well as the bypass capacitors. Short connection to ground on capacitors Cin and Cout can be implemented with the use of multiple vias. A copper area matching the TDFN exposed pad (GND) must be connected to the ground plane underneath. The use of multiple vias improves the package heat dissipation.

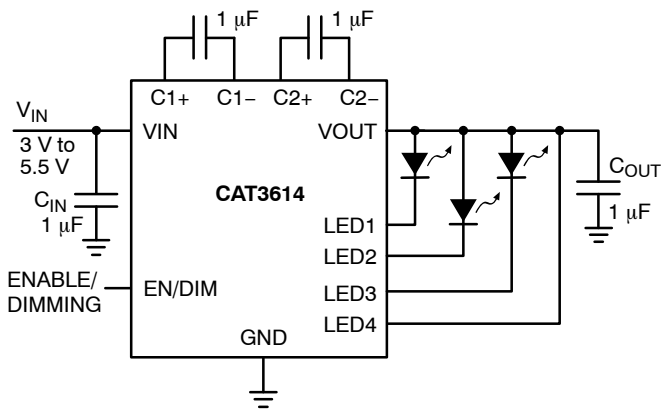

Figure 28. Three LED Application

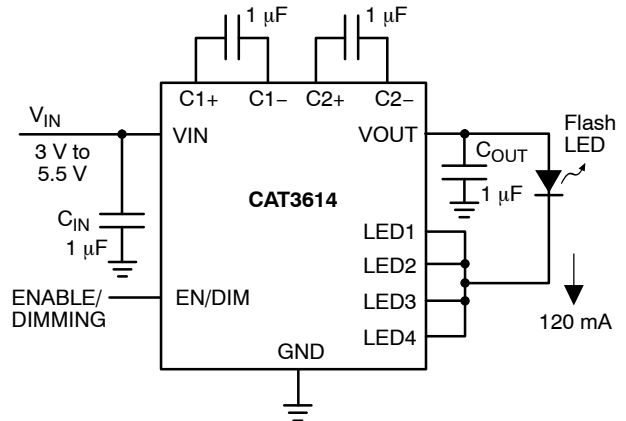
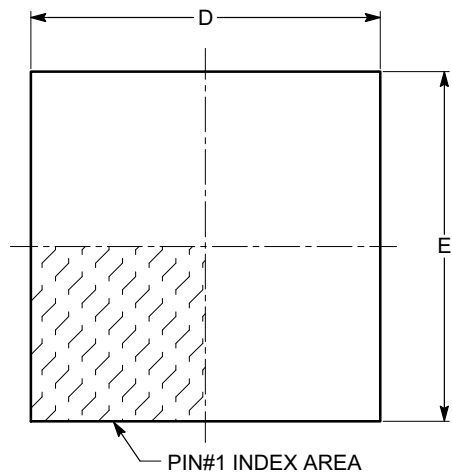

Figure 29. Single Flash LED Application

TDFN12, 3x3
CASE 511AN-01
ISSUE A

DATE 18 MAR 2009



TOP VIEW

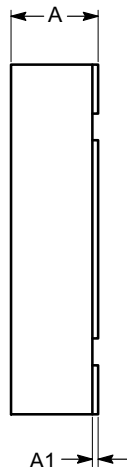

SIDE VIEW

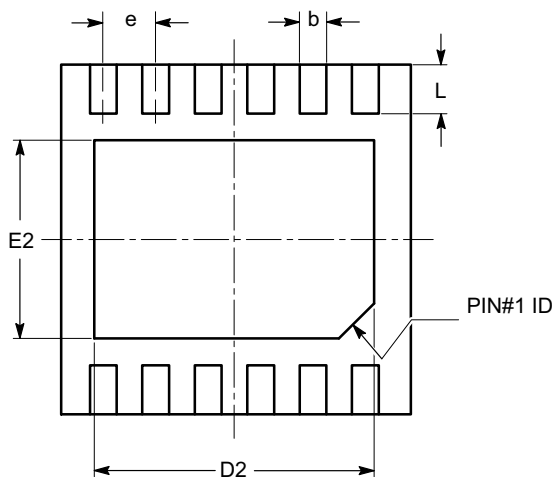

BOTTOM VIEW

SYMBOL	MIN	NOM	MAX
A	0.70	0.75	0.80
A1	0.00	0.02	0.05
A3	0.178	0.203	0.228
b	0.18	0.23	0.30
D	2.90	3.00	3.10
D2	2.30	2.40	2.50
E	2.90	3.00	3.10
E2	1.55	1.70	1.75
e	0.45 BSC		
L	0.30	0.40	0.50
M	0.25	0.30	0.35
N	0.60	0.70	0.80
P	2.70	3.00	3.10
R	2.25 TYP		

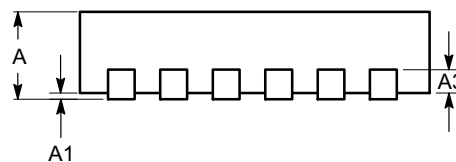

FRONT VIEW

RECOMMENDED LAND PATTERN

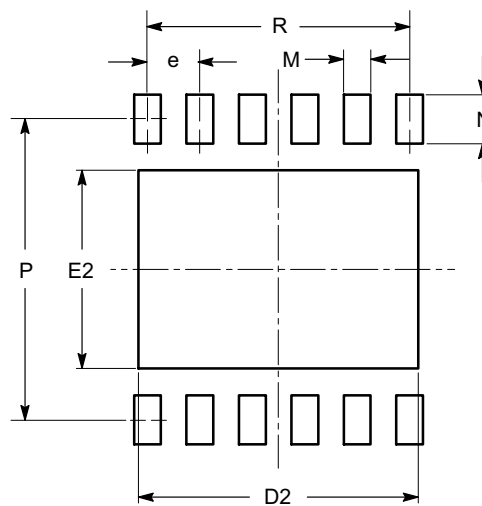

Notes:

- (1) All dimensions are in millimeters.
- (2) Complies with JEDEC MO-229.

DOCUMENT NUMBER:	98AON34357E	Electronic versions are uncontrolled except when accessed directly from the Document Repository. Printed versions are uncontrolled except when stamped "CONTROLLED COPY" in red.
DESCRIPTION:	TDFN12, 3X3	PAGE 1 OF 1

ON Semiconductor and are trademarks of Semiconductor Components Industries, LLC dba ON Semiconductor or its subsidiaries in the United States and/or other countries. ON Semiconductor reserves the right to make changes without further notice to any products herein. ON Semiconductor makes no warranty, representation or guarantee regarding the suitability of its products for any particular purpose, nor does ON Semiconductor assume any liability arising out of the application or use of any product or circuit, and specifically disclaims any and all liability, including without limitation special, consequential or incidental damages. ON Semiconductor does not convey any license under its patent rights nor the rights of others.

onsemi, **Onsemi**, and other names, marks, and brands are registered and/or common law trademarks of Semiconductor Components Industries, LLC dba "**onsemi**" or its affiliates and/or subsidiaries in the United States and/or other countries. **onsemi** owns the rights to a number of patents, trademarks, copyrights, trade secrets, and other intellectual property. A listing of **onsemi**'s product/patent coverage may be accessed at www.onsemi.com/site/pdf/Patent-Marking.pdf. **onsemi** reserves the right to make changes at any time to any products or information herein, without notice. The information herein is provided "as-is" and **onsemi** makes no warranty, representation or guarantee regarding the accuracy of the information, product features, availability, functionality, or suitability of its products for any particular purpose, nor does **onsemi** assume any liability arising out of the application or use of any product or circuit, and specifically disclaims any and all liability, including without limitation special, consequential or incidental damages. Buyer is responsible for its products and applications using **onsemi** products, including compliance with all laws, regulations and safety requirements or standards, regardless of any support or applications information provided by **onsemi**. "Typical" parameters which may be provided in **onsemi** data sheets and/or specifications can and do vary in different applications and actual performance may vary over time. All operating parameters, including "Typicals" must be validated for each customer application by customer's technical experts. **onsemi** does not convey any license under any of its intellectual property rights nor the rights of others. **onsemi** products are not designed, intended, or authorized for use as a critical component in life support systems or any FDA Class 3 medical devices or medical devices with a same or similar classification in a foreign jurisdiction or any devices intended for implantation in the human body. Should Buyer purchase or use **onsemi** products for any such unintended or unauthorized application, Buyer shall indemnify and hold **onsemi** and its officers, employees, subsidiaries, affiliates, and distributors harmless against all claims, costs, damages, and expenses, and reasonable attorney fees arising out of, directly or indirectly, any claim of personal injury or death associated with such unintended or unauthorized use, even if such claim alleges that **onsemi** was negligent regarding the design or manufacture of the part. **onsemi** is an Equal Opportunity/Affirmative Action Employer. This literature is subject to all applicable copyright laws and is not for resale in any manner.

PUBLICATION ORDERING INFORMATION

LITERATURE FULFILLMENT:

Email Requests to: orderlit@onsemi.com

onsemi Website: www.onsemi.com

TECHNICAL SUPPORT

North American Technical Support:

Voice Mail: 1 800-282-9855 Toll Free USA/Canada

Phone: 011 421 33 790 2910

Europe, Middle East and Africa Technical Support:

Phone: 00421 33 790 2910

For additional information, please contact your local Sales Representative