



**CY7C1380D, CY7C1382D  
CY7C1380F, CY7C1382F**

## 18-Mbit (512K x 36/1M x 18) Pipelined SRAM

### Features

- Supports bus operation up to 250 MHz
- Available speed grades are 250, 200, and 167 MHz
- Registered inputs and outputs for pipelined operation
- 3.3V core power supply
- 2.5V or 3.3V I/O power supply
- Fast clock-to-output times
  - 2.6 ns (for 250 MHz device)
- Provides high performance 3-1-1 access rate
- User selectable burst counter supporting Intel Pentium® interleaved or linear burst sequences
- Separate processor and controller address strobes
- Synchronous self-timed write
- Asynchronous output enable
- Single cycle chip deselect
- CY7C1380D/CY7C1382D is available in JEDEC-standard Pb-free 100-pin TQFP, Pb-free and non Pb-free 165-ball FBGA package; CY7C1380F/CY7C1382F is available in JEDEC-standard Pb-free 100-pin TQFP, Pb-free and non Pb-free 119-ball BGA and 165-ball FBGA package
- IEEE 1149.1 JTAG-Compatible Boundary Scan
- ZZ sleep mode option

### Selection Guide

Description	250 MHz	200 MHz	167 MHz	Unit
Maximum Access Time	2.6	3.0	3.4	ns
Maximum Operating Current	350	300	275	mA
Maximum CMOS Standby Current	70	70	70	mA

### Functional Description

The CY7C1380D/CY7C1382D/CY7C1380F/CY7C1382F<sup>[1]</sup> SRAM integrates 524,288 x 36 and 1,048,576 x 18 SRAM cells with advanced synchronous peripheral circuitry and a two-bit counter for internal burst operation. All synchronous inputs are gated by registers controlled by a positive edge triggered clock input (CLK). The synchronous inputs include all addresses, all data inputs, address-pipelining chip enable ( $\overline{CE}_1$ ), depth-expansion chip enables ( $CE_2$  and  $\overline{CE}_3$  <sup>[2]</sup>), burst control inputs (ADSC, ADSP, and ADV), write enables ( $BW_X$  and  $BWE$ ), and global write (GW). Asynchronous inputs include the output enable ( $\overline{OE}$ ) and the ZZ pin.

Addresses and chip enables are registered at rising edge of clock when address strobe processor (ADSP) or address strobe controller (ADSC) are active. Subsequent burst addresses can be internally generated as they are controlled by the advance pin (ADV).

Address, data inputs, and write controls are registered on-chip to initiate a self-timed write cycle. This part supports byte write operations (see Table 1 on page 6 and "Truth Table" on page 10 for further details). Write cycles can be one to two or four bytes wide as controlled by the byte write control inputs.  $\overline{GW}$  when active LOW causes all bytes to be written.

The CY7C1380D/CY7C1382D/CY7C1380F/CY7C1382F operates from a +3.3V core power supply while all outputs operate with a +2.5 or +3.3V power supply. All inputs and outputs are JEDEC-standard and JESD8-5-compatible.

#### Notes

1. For best practices or recommendations, please refer to the Cypress application note AN1064, *SRAM System Design Guidelines* on [www.cypress.com](http://www.cypress.com).
2.  $\overline{CE}_3$ ,  $CE_2$  are for TQFP and 165 FBGA packages only. 119 BGA is offered only in 1 chip enable.

**Logic Block Diagram – CY7C1380D/CY7C1380F [3] (512K x 36)**

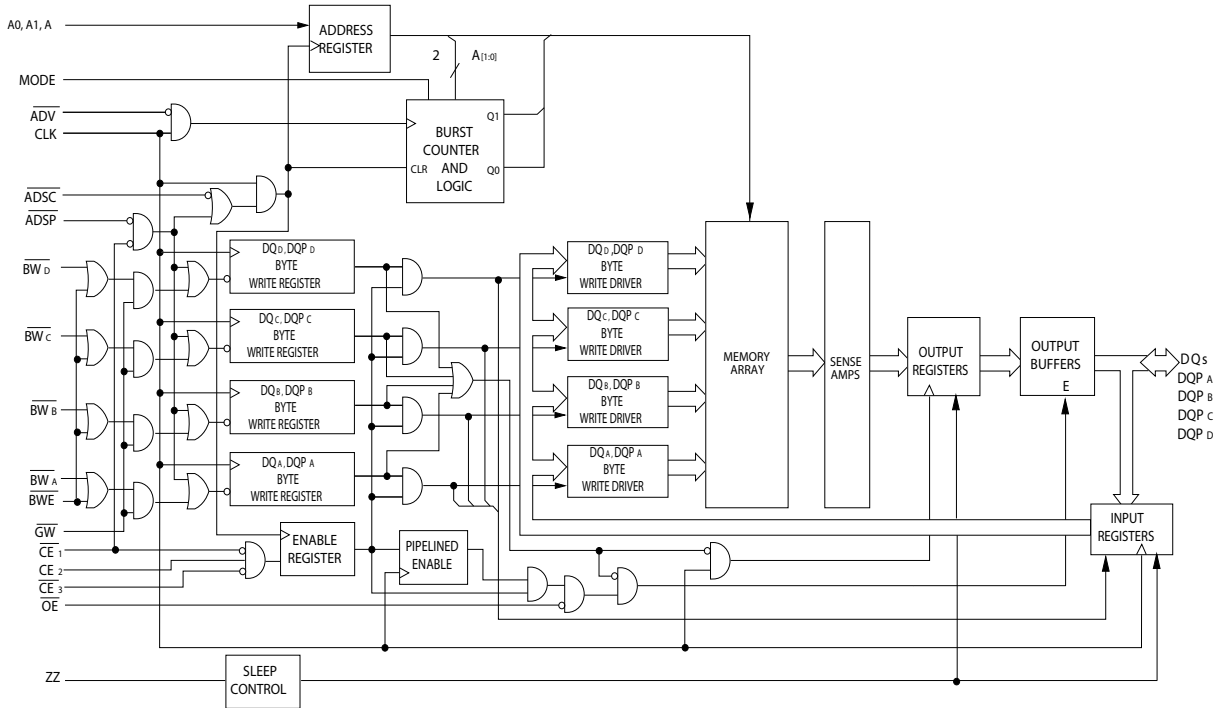

**Logic Block Diagram – CY7C1382D/CY7C1382F [3] (1M x 18)**

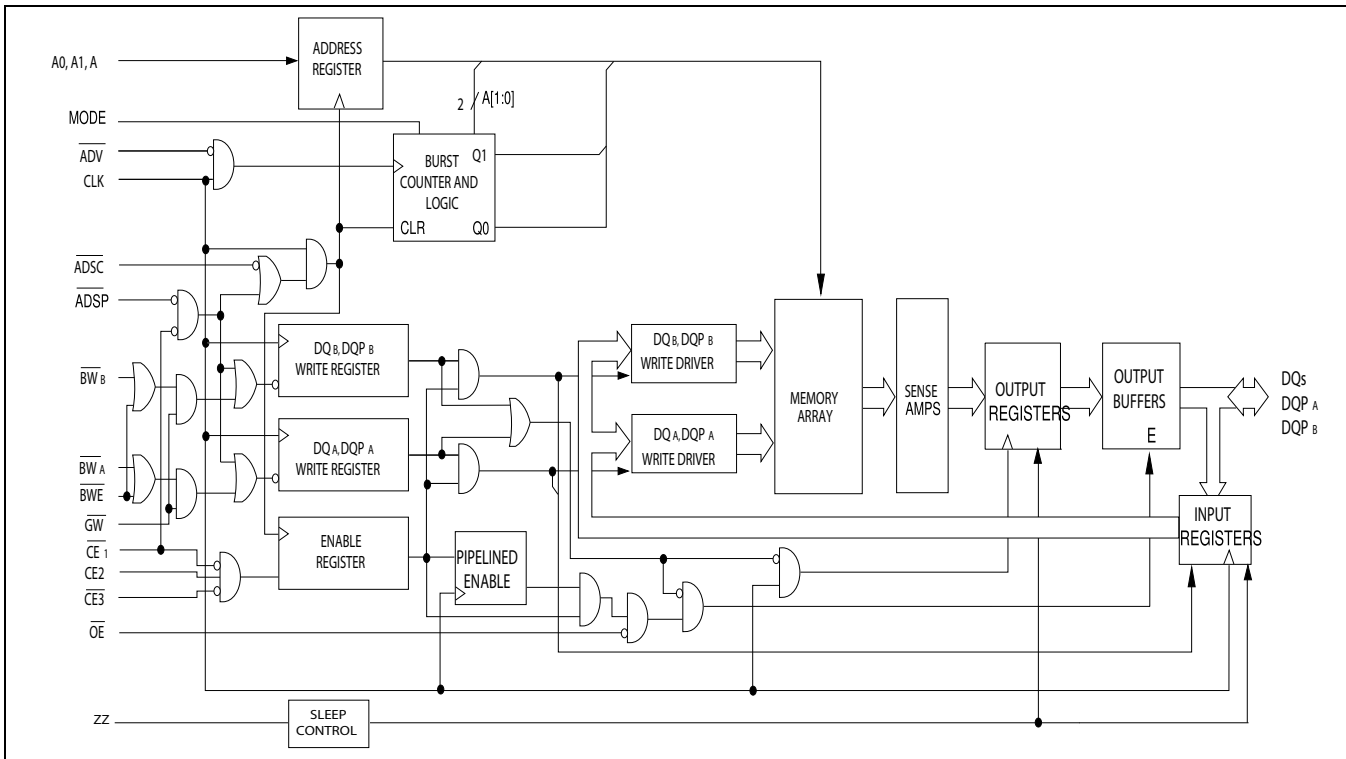

**Note**  
3. CY7C1380F and CY7C1382F in 119-ball BGA package have only 1 chip enable ( $\overline{CE}_1$ ).

## Pin Configurations

### 100-Pin TQFP Pinout (3-Chip Enable)

Figure 1. CY7C1380D, CY7C1380F(512K X 36)

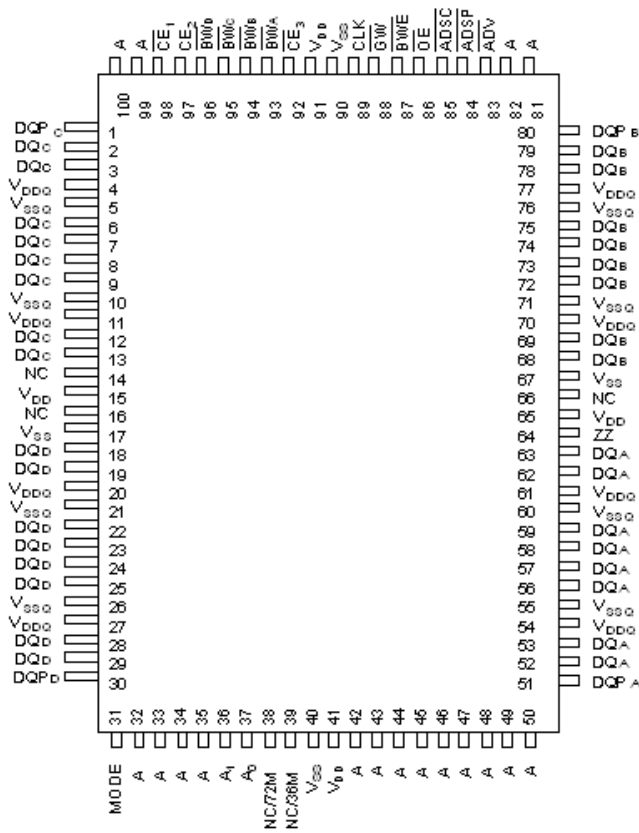
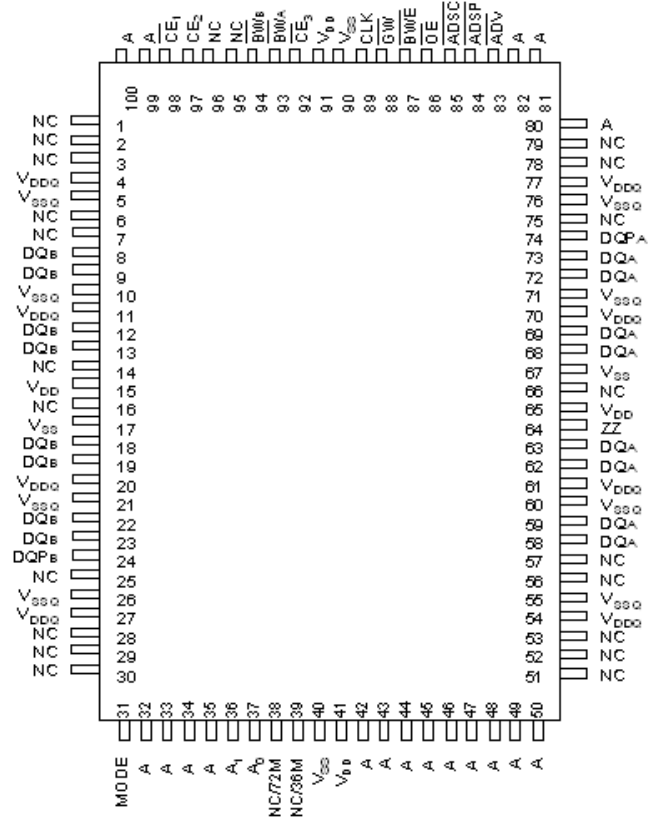

Figure 2. CY7C1382D, CY7C1382F (1M X 18)



**119-Ball BGA Pinout**

**Figure 3. CY7C1380F (512K X 36)**

	1	2	3	4	5	6	7
<b>A</b>	V <sub>DDQ</sub>	A	A	$\overline{\text{ADSP}}$	A	A	V <sub>DDQ</sub>
<b>B</b>	NC/288M	A	A	$\overline{\text{ADSC}}$	A	A	NC/576M
<b>C</b>	NC/144M	A	A	V <sub>DD</sub>	A	A	NC/1G
<b>D</b>	DQ <sub>C</sub>	DQP <sub>C</sub>	V <sub>SS</sub>	NC	V <sub>SS</sub>	DQP <sub>B</sub>	DQ <sub>B</sub>
<b>E</b>	DQ <sub>C</sub>	DQ <sub>C</sub>	V <sub>SS</sub>	$\overline{\text{CE}}_1$	V <sub>SS</sub>	DQ <sub>B</sub>	DQ <sub>B</sub>
<b>F</b>	V <sub>DDQ</sub>	DQ <sub>C</sub>	V <sub>SS</sub>	$\overline{\text{OE}}$	V <sub>SS</sub>	DQ <sub>B</sub>	V <sub>DDQ</sub>
<b>G</b>	DQ <sub>C</sub>	DQ <sub>C</sub>	$\overline{\text{BW}}_C$	$\overline{\text{ADV}}$	$\overline{\text{BW}}_B$	DQ <sub>B</sub>	DQ <sub>B</sub>
<b>H</b>	DQ <sub>C</sub>	DQ <sub>C</sub>	V <sub>SS</sub>	$\overline{\text{GW}}$	V <sub>SS</sub>	DQ <sub>B</sub>	DQ <sub>B</sub>
<b>J</b>	V <sub>DDQ</sub>	V <sub>DD</sub>	NC	V <sub>DD</sub>	NC	V <sub>DD</sub>	V <sub>DDQ</sub>
<b>K</b>	DQ <sub>D</sub>	DQ <sub>D</sub>	V <sub>SS</sub>	CLK	V <sub>SS</sub>	DQ <sub>A</sub>	DQ <sub>A</sub>
<b>L</b>	DQ <sub>D</sub>	DQ <sub>D</sub>	$\overline{\text{BW}}_D$	NC	$\overline{\text{BW}}_A$	DQ <sub>A</sub>	DQ <sub>A</sub>
<b>M</b>	V <sub>DDQ</sub>	DQ <sub>D</sub>	V <sub>SS</sub>	$\overline{\text{BWE}}$	V <sub>SS</sub>	DQ <sub>A</sub>	V <sub>DDQ</sub>
<b>N</b>	DQ <sub>D</sub>	DQ <sub>D</sub>	V <sub>SS</sub>	A1	V <sub>SS</sub>	DQ <sub>A</sub>	DQ <sub>A</sub>
<b>P</b>	DQ <sub>D</sub>	DQP <sub>D</sub>	V <sub>SS</sub>	A0	V <sub>SS</sub>	DQP <sub>A</sub>	DQ <sub>A</sub>
<b>R</b>	NC	A	MODE	V <sub>DD</sub>	NC	A	NC
<b>T</b>	NC	NC/72M	A	A	A	NC/36M	ZZ
<b>U</b>	V <sub>DDQ</sub>	TMS	TDI	TCK	TDO	NC	V <sub>DDQ</sub>

**Figure 4. CY7C1382F (1M X 18)**

	1	2	3	4	5	6	7
<b>A</b>	V <sub>DDQ</sub>	A	A	$\overline{\text{ADSP}}$	A	A	V <sub>DDQ</sub>
<b>B</b>	NC/288M	A	A	$\overline{\text{ADSC}}$	A	A	NC/576M
<b>C</b>	NC/144M	A	A	V <sub>DD</sub>	A	A	NC/1G
<b>D</b>	DQ <sub>B</sub>	NC	V <sub>SS</sub>	NC	V <sub>SS</sub>	DQP <sub>A</sub>	NC
<b>E</b>	NC	DQ <sub>B</sub>	V <sub>SS</sub>	$\overline{\text{CE}}_1$	V <sub>SS</sub>	NC	DQ <sub>A</sub>
<b>F</b>	V <sub>DDQ</sub>	NC	V <sub>SS</sub>	$\overline{\text{OE}}$	V <sub>SS</sub>	DQ <sub>A</sub>	V <sub>DDQ</sub>
<b>G</b>	NC	DQ <sub>B</sub>	$\overline{\text{BW}}_B$	$\overline{\text{ADV}}$	NC	NC	DQ <sub>A</sub>
<b>H</b>	DQ <sub>B</sub>	NC	V <sub>SS</sub>	$\overline{\text{GW}}$	V <sub>SS</sub>	DQ <sub>A</sub>	NC
<b>J</b>	V <sub>DDQ</sub>	V <sub>DD</sub>	NC	V <sub>DD</sub>	NC	V <sub>DD</sub>	V <sub>DDQ</sub>
<b>K</b>	NC	DQ <sub>B</sub>	V <sub>SS</sub>	CLK	V <sub>SS</sub>	NC	DQ <sub>A</sub>
<b>L</b>	DQ <sub>B</sub>	NC	NC	NC	$\overline{\text{BW}}_A$	DQ <sub>A</sub>	NC
<b>M</b>	V <sub>DDQ</sub>	DQ <sub>B</sub>	V <sub>SS</sub>	$\overline{\text{BWE}}$	V <sub>SS</sub>	NC	V <sub>DDQ</sub>
<b>N</b>	DQ <sub>B</sub>	NC	V <sub>SS</sub>	A1	V <sub>SS</sub>	DQ <sub>A</sub>	NC
<b>P</b>	NC	DQP <sub>B</sub>	V <sub>SS</sub>	A0	V <sub>SS</sub>	NC	DQ <sub>A</sub>
<b>R</b>	NC	A	MODE	V <sub>DD</sub>	NC	A	NC
<b>T</b>	NC/72M	A	A	NC/36M	A	A	ZZ
<b>U</b>	V <sub>DDQ</sub>	TMS	TDI	TCK	TDO	NC	V <sub>DDQ</sub>

**165-Ball FBGA Pinout (3-Chip Enable)**

**Figure 5. CY7C1380D/CY7C1380F (512K x 36)**

	1	2	3	4	5	6	7	8	9	10	11
<b>A</b>	NC/288M	A	$\overline{CE}_1$	$\overline{BW}_C$	$\overline{BW}_B$	$\overline{CE}_3$	$\overline{BWE}$	$\overline{ADSC}$	$\overline{ADV}$	A	NC
<b>B</b>	NC/144M	A	CE2	$\overline{BW}_D$	$\overline{BW}_A$	CLK	$\overline{GW}$	$\overline{OE}$	$\overline{ADSP}$	A	NC/576M
<b>C</b>	DQP <sub>C</sub>	NC	V <sub>DDQ</sub>	V <sub>SS</sub>	V <sub>SS</sub>	V <sub>SS</sub>	V <sub>SS</sub>	V <sub>SS</sub>	V <sub>DDQ</sub>	NC/1G	DQP <sub>B</sub>
<b>D</b>	DQ <sub>C</sub>	DQ <sub>C</sub>	V <sub>DDQ</sub>	V <sub>DD</sub>	V <sub>SS</sub>	V <sub>SS</sub>	V <sub>SS</sub>	V <sub>DD</sub>	V <sub>DDQ</sub>	DQ <sub>B</sub>	DQ <sub>B</sub>
<b>E</b>	DQ <sub>C</sub>	DQ <sub>C</sub>	V <sub>DDQ</sub>	V <sub>DD</sub>	V <sub>SS</sub>	V <sub>SS</sub>	V <sub>SS</sub>	V <sub>DD</sub>	V <sub>DDQ</sub>	DQ <sub>B</sub>	DQ <sub>B</sub>
<b>F</b>	DQ <sub>C</sub>	DQ <sub>C</sub>	V <sub>DDQ</sub>	V <sub>DD</sub>	V <sub>SS</sub>	V <sub>SS</sub>	V <sub>SS</sub>	V <sub>DD</sub>	V <sub>DDQ</sub>	DQ <sub>B</sub>	DQ <sub>B</sub>
<b>G</b>	DQ <sub>C</sub>	DQ <sub>C</sub>	V <sub>DDQ</sub>	V <sub>DD</sub>	V <sub>SS</sub>	V <sub>SS</sub>	V <sub>SS</sub>	V <sub>DD</sub>	V <sub>DDQ</sub>	DQ <sub>B</sub>	DQ <sub>B</sub>
<b>H</b>	NC	NC	NC	V <sub>DD</sub>	V <sub>SS</sub>	V <sub>SS</sub>	V <sub>SS</sub>	V <sub>DD</sub>	NC	NC	ZZ
<b>J</b>	DQ <sub>D</sub>	DQ <sub>D</sub>	V <sub>DDQ</sub>	V <sub>DD</sub>	V <sub>SS</sub>	V <sub>SS</sub>	V <sub>SS</sub>	V <sub>DD</sub>	V <sub>DDQ</sub>	DQ <sub>A</sub>	DQ <sub>A</sub>
<b>K</b>	DQ <sub>D</sub>	DQ <sub>D</sub>	V <sub>DDQ</sub>	V <sub>DD</sub>	V <sub>SS</sub>	V <sub>SS</sub>	V <sub>SS</sub>	V <sub>DD</sub>	V <sub>DDQ</sub>	DQ <sub>A</sub>	DQ <sub>A</sub>
<b>L</b>	DQ <sub>D</sub>	DQ <sub>D</sub>	V <sub>DDQ</sub>	V <sub>DD</sub>	V <sub>SS</sub>	V <sub>SS</sub>	V <sub>SS</sub>	V <sub>DD</sub>	V <sub>DDQ</sub>	DQ <sub>A</sub>	DQ <sub>A</sub>
<b>M</b>	DQ <sub>D</sub>	DQ <sub>D</sub>	V <sub>DDQ</sub>	V <sub>DD</sub>	V <sub>SS</sub>	V <sub>SS</sub>	V <sub>SS</sub>	V <sub>DD</sub>	V <sub>DDQ</sub>	DQ <sub>A</sub>	DQ <sub>A</sub>
<b>N</b>	DQP <sub>D</sub>	NC	V <sub>DDQ</sub>	V <sub>SS</sub>	NC	A	NC	V <sub>SS</sub>	V <sub>DDQ</sub>	NC	DQP <sub>A</sub>
<b>P</b>	NC	NC/72M	A	A	TDI	A1	TDO	A	A	A	A
<b>R</b>	MODE	NC/36M	A	A	TMS	A0	TCK	A	A	A	A

**Figure 6. CY7C1382D/CY7C1382F (1M x 18)**

	1	2	3	4	5	6	7	8	9	10	11
<b>A</b>	NC/288M	A	$\overline{CE}_1$	$\overline{BW}_B$	NC	$\overline{CE}_3$	$\overline{BWE}$	$\overline{ADSC}$	$\overline{ADV}$	A	A
<b>B</b>	NC/144M	A	CE2	NC	$\overline{BW}_A$	CLK	$\overline{GW}$	$\overline{OE}$	$\overline{ADSP}$	A	NC/576M
<b>C</b>	NC	NC	V <sub>DDQ</sub>	V <sub>SS</sub>	V <sub>SS</sub>	V <sub>SS</sub>	V <sub>SS</sub>	V <sub>SS</sub>	V <sub>DDQ</sub>	NC/1G	DQP <sub>A</sub>
<b>D</b>	NC	DQ <sub>B</sub>	V <sub>DDQ</sub>	V <sub>DD</sub>	V <sub>SS</sub>	V <sub>SS</sub>	V <sub>SS</sub>	V <sub>DD</sub>	V <sub>DDQ</sub>	NC	DQ <sub>A</sub>
<b>E</b>	NC	DQ <sub>B</sub>	V <sub>DDQ</sub>	V <sub>DD</sub>	V <sub>SS</sub>	V <sub>SS</sub>	V <sub>SS</sub>	V <sub>DD</sub>	V <sub>DDQ</sub>	NC	DQ <sub>A</sub>
<b>F</b>	NC	DQ <sub>B</sub>	V <sub>DDQ</sub>	V <sub>DD</sub>	V <sub>SS</sub>	V <sub>SS</sub>	V <sub>SS</sub>	V <sub>DD</sub>	V <sub>DDQ</sub>	NC	DQ <sub>A</sub>
<b>G</b>	NC	DQ <sub>B</sub>	V <sub>DDQ</sub>	V <sub>DD</sub>	V <sub>SS</sub>	V <sub>SS</sub>	V <sub>SS</sub>	V <sub>DD</sub>	V <sub>DDQ</sub>	NC	DQ <sub>A</sub>
<b>H</b>	NC	NC	NC	V <sub>DD</sub>	V <sub>SS</sub>	V <sub>SS</sub>	V <sub>SS</sub>	V <sub>DD</sub>	NC	NC	ZZ
<b>J</b>	DQ <sub>B</sub>	NC	V <sub>DDQ</sub>	V <sub>DD</sub>	V <sub>SS</sub>	V <sub>SS</sub>	V <sub>SS</sub>	V <sub>DD</sub>	V <sub>DDQ</sub>	DQ <sub>A</sub>	NC
<b>K</b>	DQ <sub>B</sub>	NC	V <sub>DDQ</sub>	V <sub>DD</sub>	V <sub>SS</sub>	V <sub>SS</sub>	V <sub>SS</sub>	V <sub>DD</sub>	V <sub>DDQ</sub>	DQ <sub>A</sub>	NC
<b>L</b>	DQ <sub>B</sub>	NC	V <sub>DDQ</sub>	V <sub>DD</sub>	V <sub>SS</sub>	V <sub>SS</sub>	V <sub>SS</sub>	V <sub>DD</sub>	V <sub>DDQ</sub>	DQ <sub>A</sub>	NC
<b>M</b>	DQ <sub>B</sub>	NC	V <sub>DDQ</sub>	V <sub>DD</sub>	V <sub>SS</sub>	V <sub>SS</sub>	V <sub>SS</sub>	V <sub>DD</sub>	V <sub>DDQ</sub>	DQ <sub>A</sub>	NC
<b>N</b>	DQP <sub>B</sub>	NC	V <sub>DDQ</sub>	V <sub>SS</sub>	NC	A	NC	V <sub>SS</sub>	V <sub>DDQ</sub>	NC	NC
<b>P</b>	NC	NC/72M	A	A	TDI	A1	TDO	A	A	A	A
<b>R</b>	MODE	NC/36M	A	A	TMS	A0	TCK	A	A	A	A

**Table 1. Pin Definitions**

Name	I/O	Description
A <sub>0</sub> , A <sub>1</sub> , A	Input-Synchronous	<b>Address inputs used to select one of the address locations.</b> Sampled at the rising edge of the CLK if ADSP or ADSC is active LOW, and CE <sub>1</sub> , CE <sub>2</sub> , and CE <sub>3</sub> <sup>[2]</sup> are sampled active. A1: A0 are fed to the two-bit counter.
$\overline{BW}_A$ , $\overline{BW}_B$ $\overline{BW}_C$ , $\overline{BW}_D$	Input-Synchronous	<b>Byte write select inputs, active LOW.</b> Qualified with $\overline{BWE}$ to conduct byte writes to the SRAM. Sampled on the rising edge of CLK.
$\overline{GW}$	Input-Synchronous	<b>Global write enable input, active LOW.</b> When asserted LOW on the rising edge of CLK, a global write is conducted (all bytes are written, regardless of the values on BW <sub>x</sub> and BWE).
$\overline{BWE}$	Input-Synchronous	<b>Byte write enable input, active LOW.</b> Sampled on the rising edge of CLK. This signal must be asserted LOW to conduct a byte write.
CLK	Input-Clock	<b>Clock input.</b> Used to capture all synchronous inputs to the device. Also used to increment the burst counter when ADV is asserted LOW, during a burst operation.
$\overline{CE}_1$	Input-Synchronous	<b>Chip enable 1 input, active LOW.</b> Sampled on the rising edge of CLK. Used in conjunction with CE <sub>2</sub> and CE <sub>3</sub> to select or deselect the device. ADSP is ignored if CE <sub>1</sub> is HIGH. CE <sub>1</sub> is sampled only when a new external address is loaded.
CE <sub>2</sub> <sup>[2]</sup>	Input-Synchronous	<b>Chip enable 2 input, active HIGH.</b> Sampled on the rising edge of CLK. Used in conjunction with CE <sub>1</sub> and CE <sub>3</sub> to select or deselect the device. CE <sub>2</sub> is sampled only when a new external address is loaded.
$\overline{CE}_3$ <sup>[2]</sup>	Input-Synchronous	<b>Chip enable 3 input, active LOW.</b> Sampled on the rising edge of CLK. Used in conjunction with CE <sub>1</sub> and CE <sub>2</sub> to select or deselect the device. CE <sub>3</sub> is sampled only when a new external address is loaded.
$\overline{OE}$	Input-Asynchronous	<b>Output enable, asynchronous input, active LOW.</b> Controls the direction of the I/O pins. When LOW, the I/O pins behave as outputs. When deasserted HIGH, I/O pins are tri-stated, and act as input data pins. $\overline{OE}$ is masked during the first clock of a read cycle when emerging from a deselected state.
$\overline{ADV}$	Input-Synchronous	<b>Advance input signal, sampled on the rising edge of CLK, active LOW.</b> When asserted, it automatically increments the address in a burst cycle.
$\overline{ADSP}$	Input-Synchronous	<b>Address strobe from processor, sampled on the rising edge of CLK, active LOW.</b> When asserted LOW, addresses presented to the device are captured in the address registers. A1: A0 are also loaded into the burst counter. When ADSP and ADSC are both asserted, only ADSP is recognized. ADSP is ignored when CE <sub>1</sub> is deasserted HIGH.
$\overline{ADSC}$	Input-Synchronous	<b>Address strobe from controller, sampled on the rising edge of CLK, active LOW.</b> When asserted LOW, addresses presented to the device are captured in the address registers. A1: A0 are also loaded into the burst counter. When ADSP and ADSC are both asserted, only ADSP is recognized.
ZZ	Input-Asynchronous	<b>ZZ sleep input.</b> This active HIGH input places the device in a non-time critical sleep condition with data integrity preserved. For normal operation, this pin has to be LOW or left floating. ZZ pin has an internal pull down.
DQs, DQP <sub>x</sub>	I/O-Synchronous	<b>Bidirectional data I/O lines.</b> As inputs, they feed into an on-chip data register that is triggered by the rising edge of CLK. As outputs, they deliver the data contained in the memory location specified by the addresses presented during the previous clock rise of the read cycle. The direction of the pins is controlled by OE. When OE is asserted LOW, the pins behave as outputs. When HIGH, DQs and DQP <sub>x</sub> are placed in a tri-state condition.
V <sub>DD</sub>	Power Supply	<b>Power supply inputs to the core of the device.</b>
V <sub>SS</sub>	Ground	<b>Ground for the core of the device.</b>
V <sub>SSQ</sub>	I/O Ground	<b>Ground for the I/O circuitry.</b>
V <sub>DDQ</sub>	I/O Power Supply	<b>Power supply for the I/O circuitry.</b>

**Table 1. Pin Definitions** (continued)

MODE	Input-Static	<b>Selects burst order.</b> When tied to GND selects linear burst sequence. When tied to $V_{DD}$ or left floating selects interleaved burst sequence. This is a strap pin and must remain static during device operation. Mode pin has an internal pull up.
TDO	JTAG serial output Synchronous	<b>Serial data-out to the JTAG circuit.</b> Delivers data on the negative edge of TCK. If the JTAG feature is not being utilized, this pin must be disconnected. This pin is not available on TQFP packages.
TDI	JTAG serial input Synchronous	<b>Serial data-in to the JTAG circuit.</b> Sampled on the rising edge of TCK. If the JTAG feature is not being utilized, this pin can be disconnected or connected to $V_{DD}$ . This pin is not available on TQFP packages.
TMS	JTAG serial input Synchronous	<b>Serial data-in to the JTAG circuit.</b> Sampled on the rising edge of TCK. If the JTAG feature is not being utilized, this pin can be disconnected or connected to $V_{DD}$ . This pin is not available on TQFP packages.
TCK	JTAG-Clock	<b>Clock input to the JTAG circuitry.</b> If the JTAG feature is not being utilized, this pin must be connected to $V_{SS}$ . This pin is not available on TQFP packages.
NC	–	<b>No Connects.</b> 36M, 72M, 144M, 288M, 576M, and 1G are address expansion pins and are not internally connected to the die.



## Functional Overview

All synchronous inputs pass through input registers controlled by the rising edge of the clock. All data outputs pass through output registers controlled by the rising edge of the clock. Maximum access delay from the clock rise ( $t_{CO}$ ) is 2.6 ns (250 MHz device). The CY7C1380D/CY7C1382D/CY7C1380F/CY7C1382F supports secondary cache in systems using a linear or interleaved burst sequence. The interleaved burst order supports Pentium and i486™ processors. The linear burst sequence suits processors that use a linear burst sequence. The burst order is user selectable, and is determined by sampling the MODE input. Accesses can be initiated with either the processor address strobe (ADSP) or the controller address strobe (ADSC). Address advancement through the burst sequence is controlled by the ADV input. A two-bit on-chip wraparound burst counter captures the first address in a burst sequence and automatically increments the address for the rest of the burst access.

Byte write operations are qualified with the byte write enable (BWE) and byte write select (BW<sub>X</sub>) inputs. A global write enable (GW) overrides all byte write inputs and writes data to all four bytes. All writes are simplified with on-chip synchronous self-timed write circuitry.

Three synchronous chip selects ( $\overline{CE}_1$ , CE<sub>2</sub>,  $\overline{CE}_3$ ) and an asynchronous output enable (OE) provide for easy bank selection and output tri-state control. ADSP is ignored if  $\overline{CE}_1$  is HIGH.

### Single Read Accesses

This access is initiated when the following conditions are satisfied at clock rise: (1) ADSP or ADSC is asserted LOW, (2)  $\overline{CE}_1$ , CE<sub>2</sub>,  $\overline{CE}_3$  are all asserted active, and (3) the write signals (GW, BWE) are all deserted HIGH. ADSP is ignored if  $\overline{CE}_1$  is HIGH. The address presented to the address inputs (A) is stored into the address advancement logic and the address register while being presented to the memory array. The corresponding data is enabled to propagate to the input of the output registers. At the rising edge of the next clock, the data is enabled to propagate through the output register and onto the data bus within 2.6 ns (250 MHz device) if OE is active LOW. The only exception occurs when the SRAM is emerging from a deselected state to a selected state; its outputs are always tri-stated during the first cycle of the access. After the first cycle of the access, the outputs are controlled by the OE signal. Consecutive single read cycles are supported. Once the SRAM is deselected at clock rise by the chip select and either ADSP or ADSC signals, its output tri-states immediately.

### Single Write Accesses Initiated by ADSP

This access is initiated when both the following conditions are satisfied at clock rise: (1) ADSP is asserted LOW and (2)  $\overline{CE}_1$ , CE<sub>2</sub>, and  $\overline{CE}_3$  are all asserted active. The address presented to A is loaded into the address register and the address advancement logic while being delivered to the memory array. The write signals (GW, BWE, and BW<sub>X</sub>) and ADV inputs are ignored during this first cycle.

ADSP triggered write accesses require two clock cycles to complete. If GW is asserted LOW on the second clock rise, the data presented to the DQs inputs is written into the corresponding address location in the memory array. If GW is HIGH, then the write operation is controlled by BWE and BW<sub>X</sub> signals.

The CY7C1380D/CY7C1382D/CY7C1380F/CY7C1382F provides byte write capability that is described in the write cycle descriptions table. Asserting the byte write enable input (BWE) with the selected byte write (BW<sub>X</sub>) input, selectively writes to only the desired bytes. Bytes not selected during a byte write operation remain unaltered. A synchronous self-timed write mechanism has been provided to simplify the write operations.

The CY7C1380D/CY7C1382D/CY7C1380F/CY7C1382F is a common I/O device, the output enable ( $\overline{OE}$ ) must be deserted HIGH before presenting data to the DQs inputs. Doing so tri-states the output drivers. As a safety precaution, DQs are automatically tri-stated whenever a write cycle is detected, regardless of the state of  $\overline{OE}$ .

### Single Write Accesses Initiated by ADSC

ADSC write accesses are initiated when the following conditions are satisfied: (1) ADSC is asserted LOW, (2) ADSP is deserted HIGH, (3)  $\overline{CE}_1$ , CE<sub>2</sub>, and  $\overline{CE}_3$  are all asserted active, and (4) the appropriate combination of the write inputs (GW, BWE, and BW<sub>X</sub>) are asserted active to conduct a write to the desired byte(s). ADSC-triggered Write accesses require a single clock cycle to complete. The address presented to A is loaded into the address register and the address advancement logic while being delivered to the memory array. The ADV input is ignored during this cycle. If a global write is conducted, the data presented to the DQs is written into the corresponding address location in the memory core. If a byte write is conducted, only the selected bytes are written. Bytes not selected during a byte write operation remain unaltered. A synchronous self-timed write mechanism has been provided to simplify the write operations.

The CY7C1380D/CY7C1382D/CY7C1380F/CY7C1382F is a common I/O device, the output enable (OE) must be deserted HIGH before presenting data to the DQs inputs. Doing so tri-states the output drivers. As a safety precaution, DQs are automatically tri-stated whenever a write cycle is detected, regardless of the state of OE.



### Burst Sequences

The CY7C1380D/CY7C1382D/CY7C1380F/CY7C1382F provides a two-bit wraparound counter, fed by A1: A0, that implements an interleaved or a linear burst sequence. The interleaved burst sequence is designed specifically to support Intel Pentium applications. The linear burst sequence is designed to support processors that follow a linear burst sequence. The burst sequence is user selectable through the MODE input.

Asserting  $\overline{ADV}$  LOW at clock rise automatically increments the burst counter to the next address in the burst sequence. Both read and write burst operations are supported.

### Sleep Mode

The ZZ input pin is an asynchronous input. Asserting ZZ places the SRAM in a power conservation sleep mode. Two clock cycles are required to enter into or exit from this sleep mode. While in this mode, data integrity is guaranteed. Accesses pending when entering the sleep mode are not considered valid nor is the completion of the operation guaranteed. The device must be deselected prior to entering the sleep mode.  $\overline{CE}_1$ ,  $\overline{CE}_2$ ,  $\overline{CE}_3$ , ADSP, and ADSC must remain inactive for the duration of  $t_{ZZREC}$  after the ZZ input returns LOW.

**Table 2. Interleaved Burst Address Table (MODE = Floating or VDD)**

First Address A1: A0	Second Address A1: A0	Third Address A1: A0	Fourth Address A1: A0
00	01	10	11
01	00	11	10
10	11	00	01
11	10	01	00

**Table 3. Linear Burst Address Table (MODE = GND)**

First Address A1: A0	Second Address A1: A0	Third Address A1: A0	Fourth Address A1: A0
00	01	10	11
01	10	11	00
10	11	00	01
11	00	01	10

**Table 4. ZZ Mode Electrical Characteristics**

Parameter	Description	Test Conditions	Min	Max	Unit
$I_{DDZZ}$	Sleep mode standby current	$ZZ \geq V_{DD} - 0.2V$		80	mA
$t_{ZZS}$	Device operation to ZZ	$ZZ \geq V_{DD} - 0.2V$		$2t_{CYC}$	ns
$t_{ZZREC}$	ZZ recovery time	$ZZ \leq 0.2V$	$2t_{CYC}$		ns
$t_{ZZI}$	ZZ Active to sleep current	This parameter is sampled		$2t_{CYC}$	ns
$t_{RZZI}$	ZZ Inactive to exit sleep current	This parameter is sampled	0		ns

## Truth Table

The Truth Table for this data sheet follows.<sup>[4, 5, 6, 7, 8]</sup>

Operation	Add. Used	$\overline{CE}_1$	$CE_2$	$\overline{CE}_3$	ZZ	$\overline{ADSP}$	$\overline{ADSC}$	$\overline{ADV}$	$\overline{WRITE}$	$\overline{OE}$	CLK	DQ
Deselect Cycle, Power Down	None	H	X	X	L	X	L	X	X	X	L-H	Tri-State
Deselect Cycle, Power Down	None	L	L	X	L	L	X	X	X	X	L-H	Tri-State
Deselect Cycle, Power Down	None	L	X	H	L	L	X	X	X	X	L-H	Tri-State
Deselect Cycle, Power Down	None	L	L	X	L	H	L	X	X	X	L-H	Tri-State
Deselect Cycle, Power Down	None	L	X	H	L	H	L	X	X	X	L-H	Tri-State
Sleep Mode, Power Down	None	X	X	X	H	X	X	X	X	X	X	Tri-State
READ Cycle, Begin Burst	External	L	H	L	L	L	X	X	X	L	L-H	Q
READ Cycle, Begin Burst	External	L	H	L	L	L	X	X	X	H	L-H	Tri-State
WRITE Cycle, Begin Burst	External	L	H	L	L	H	L	X	L	X	L-H	D
READ Cycle, Begin Burst	External	L	H	L	L	H	L	X	H	L	L-H	Q
READ Cycle, Begin Burst	External	L	H	L	L	H	L	X	H	H	L-H	Tri-State
READ Cycle, Continue Burst	Next	X	X	X	L	H	H	L	H	L	L-H	Q
READ Cycle, Continue Burst	Next	X	X	X	L	H	H	L	H	H	L-H	Tri-State
READ Cycle, Continue Burst	Next	H	X	X	L	X	H	L	H	L	L-H	Q
READ Cycle, Continue Burst	Next	H	X	X	L	X	H	L	H	H	L-H	Tri-State
WRITE Cycle, Continue Burst	Next	X	X	X	L	H	H	L	L	X	L-H	D
WRITE Cycle, Continue Burst	Next	H	X	X	L	X	H	L	L	X	L-H	D
READ Cycle, Suspend Burst	Current	X	X	X	L	H	H	H	H	L	L-H	Q
READ Cycle, Suspend Burst	Current	X	X	X	L	H	H	H	H	H	L-H	Tri-State
READ Cycle, Suspend Burst	Current	H	X	X	L	X	H	H	H	L	L-H	Q
READ Cycle, Suspend Burst	Current	H	X	X	L	X	H	H	H	H	L-H	Tri-State
WRITE Cycle, Suspend Burst	Current	X	X	X	L	H	H	H	L	X	L-H	D
WRITE Cycle, Suspend Burst	Current	H	X	X	L	X	H	H	L	X	L-H	D

### Notes

- X = Don't Care, H = Logic HIGH, L = Logic LOW.
- $\overline{WRITE} = L$  when any one or more byte write enable signals, and  $\overline{BWE} = L$  or  $\overline{GW} = L$ .  $\overline{WRITE} = H$  when all byte write enable signals,  $\overline{BWE}$ ,  $\overline{GW} = H$ .
- The DQ pins are controlled by the current cycle and the  $\overline{OE}$  signal.  $\overline{OE}$  is asynchronous and is not sampled with the clock.
- The SRAM always initiates a read cycle when  $\overline{ADSP}$  is asserted, regardless of the state of  $\overline{GW}$ ,  $\overline{BWE}$ , or  $\overline{BW}_x$ . Writes may occur only on subsequent clocks after the  $\overline{ADSP}$  or with the assertion of  $\overline{ADSC}$ . As a result,  $\overline{OE}$  must be driven HIGH prior to the start of the write cycle to allow the outputs to tri-state.  $\overline{OE}$  is a don't care for the remainder of the write cycle.
- $\overline{OE}$  is asynchronous and is not sampled with the clock rise. It is masked internally during write cycles. During a read cycle all data bits are tri-state when  $\overline{OE}$  is inactive or when the device is deselected, and all data bits behave as output when  $\overline{OE}$  is active (LOW).

**Truth Table for Read/Write** [4, 9]

Function (CY7C1380D/CY7C1380F)	$\overline{GW}$	$\overline{BWE}$	$\overline{BW}_D$	$\overline{BW}_C$	$\overline{BW}_B$	$\overline{BW}_A$
Read	H	H	X	X	X	X
Read	H	L	H	H	H	H
Write Byte A – (DQ <sub>A</sub> and DQP <sub>A</sub> )	H	L	H	H	H	L
Write Byte B – (DQ <sub>B</sub> and DQP <sub>B</sub> )	H	L	H	H	L	H
Write Bytes B, A	H	L	H	H	L	L
Write Byte C – (DQ <sub>C</sub> and DQP <sub>C</sub> )	H	L	H	L	H	H
Write Bytes C, A	H	L	H	L	H	L
Write Bytes C, B	H	L	H	L	L	H
Write Bytes C, B, A	H	L	H	L	L	L
Write Byte D – (DQ <sub>D</sub> and DQP <sub>D</sub> )	H	L	L	H	H	H
Write Bytes D, A	H	L	L	H	H	L
Write Bytes D, B	H	L	L	H	L	H
Write Bytes D, B, A	H	L	L	H	L	L
Write Bytes D, C	H	L	L	L	H	H
Write Bytes D, C, A	H	L	L	L	H	L
Write Bytes D, C, B	H	L	L	L	L	H
Write All Bytes	H	L	L	L	L	L
Write All Bytes	L	X	X	X	X	X

**Truth Table for Read/Write** [4, 9]

Function (CY7C1382D/CY7C1382F)	$\overline{GW}$	$\overline{BWE}$	$\overline{BW}_B$	$\overline{BW}_A$
Read	H	H	X	X
Read	H	L	H	H
Write Byte A – (DQ <sub>A</sub> and DQP <sub>A</sub> )	H	L	H	L
Write Byte B – (DQ <sub>B</sub> and DQP <sub>B</sub> )	H	L	L	H
Write Bytes B, A	H	L	L	L
Write All Bytes	H	L	L	L
Write All Bytes	L	X	X	X

**Note**

9. Table only lists a partial listing of the byte write combinations. Any combination of  $\overline{BW}_x$  is valid. Appropriate write is done based on which byte write is active.

## IEEE 1149.1 Serial Boundary Scan (JTAG)

The CY7C1380D/CY7C1382D incorporates a serial boundary scan test access port (TAP). This part is fully compliant with 1149.1. The TAP operates using JEDEC-standard 3.3V or 2.5V I/O logic levels.

The CY7C1380D/CY7C1382D contains a TAP controller, instruction register, boundary scan register, bypass register, and ID register.

### Disabling the JTAG Feature

It is possible to operate the SRAM without using the JTAG feature. To disable the TAP controller, TCK must be tied LOW ( $V_{SS}$ ) to prevent clocking of the device. TDI and TMS are internally pulled up and may be unconnected. They may alternately be connected to  $V_{DD}$  through a pull up resistor. TDO must be left unconnected. Upon power up, the device comes up in a reset state which does not interfere with the operation of the device.

### TAP Controller State Diagram

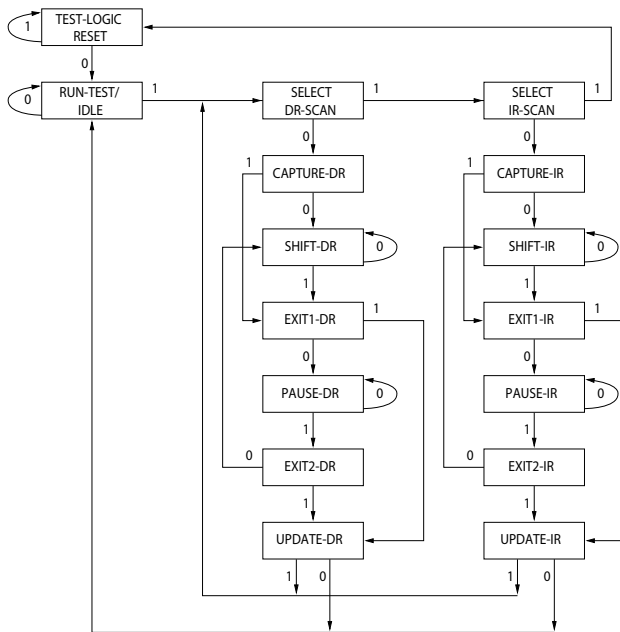

The 0 or 1 next to each state represents the value of TMS at the rising edge of TCK.

### Test Access Port (TAP)

#### Test Clock (TCK)

The test clock is used only with the TAP controller. All inputs are captured on the rising edge of TCK. All outputs are driven from the falling edge of TCK.

#### Test MODE SELECT (TMS)

The TMS input is used to give commands to the TAP controller and is sampled on the rising edge of TCK. This pin may be left unconnected if the TAP is not used. The ball is pulled up internally, resulting in a logic HIGH level.

#### Test Data-In (TDI)

The TDI ball is used to serially input information into the registers and can be connected to the input of any of the registers. The register between TDI and TDO is chosen by the instruction that is loaded into the TAP instruction register. TDI is internally pulled up and can be unconnected if the TAP is unused in an application. TDI is connected to the most significant bit (MSB) of any register. (See [TAP Controller Block Diagram](#).)

#### Test Data-Out (TDO)

The TDO output ball is used to serially clock data-out from the registers. The output is active depending upon the current state of the TAP state machine. The output changes on the falling edge of TCK. TDO is connected to the least significant bit (LSB) of any register. (See [TAP Controller State Diagram](#).)

### TAP Controller Block Diagram

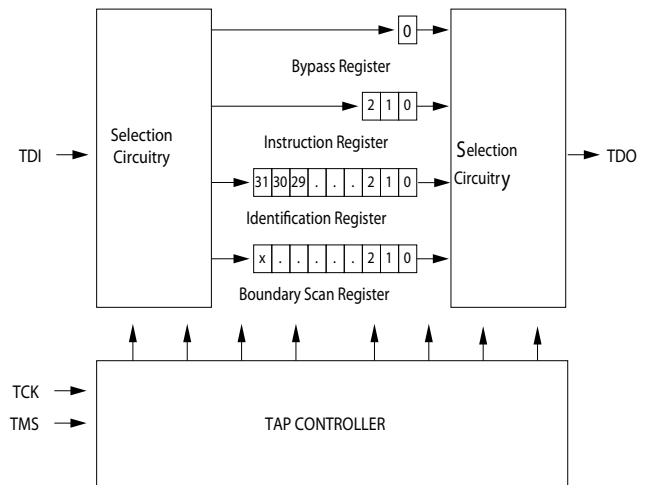

### Performing a TAP Reset

A Reset is performed by forcing TMS HIGH ( $V_{DD}$ ) for five rising edges of TCK. This Reset does not affect the operation of the SRAM and may be performed while the SRAM is operating.

At power up, the TAP is reset internally to ensure that TDO comes up in a High-Z state.

### TAP Registers

Registers are connected between the TDI and TDO balls and enable data to be scanned in and out of the SRAM test circuitry. Only one register can be selected at a time through the instruction register. Data is serially loaded into the TDI ball on the rising edge of TCK. Data is output on the TDO ball on the falling edge of TCK.

#### Instruction Register

Three-bit instructions can be serially loaded into the instruction register. This register is loaded when it is placed between the TDI and TDO balls as shown in the [TAP Controller Block Diagram](#). Upon power up, the instruction register is loaded with the IDCODE instruction. It is also loaded with the IDCODE instruction if the controller is placed in a reset state as described in the previous section.

When the TAP controller is in the Capture-IR state, the two least significant bits are loaded with a binary '01' pattern to enable fault isolation of the board-level serial test data path.

#### *Bypass Register*

To save time when serially shifting data through registers, it is sometimes advantageous to skip certain chips. The bypass register is a single-bit register that can be placed between the TDI and TDO balls. This enables data to be shifted through the SRAM with minimal delay. The bypass register is set LOW ( $V_{SS}$ ) when the BYPASS instruction is executed.

#### *Boundary Scan Register*

The boundary scan register is connected to all the input and bidirectional balls on the SRAM.

The boundary scan register is loaded with the contents of the RAM input and output ring when the TAP controller is in the Capture-DR state and is then placed between the TDI and TDO balls when the controller is moved to the Shift-DR state. The EXTEST, SAMPLE/PRELOAD, and SAMPLE Z instructions can be used to capture the contents of the input and output ring.

The boundary scan order tables show the order in which the bits are connected. Each bit corresponds to one of the bumps on the SRAM package. The MSB of the register is connected to TDI, and the LSB is connected to TDO.

#### *Identification (ID) Register*

The ID register is loaded with a vendor-specific 32-bit code during the Capture-DR state when the IDCODE command is loaded in the instruction register. The IDCODE is hardwired into the SRAM and can be shifted out when the TAP controller is in the Shift-DR state. The ID register has a vendor code and other information described in the ["Identification Register Definitions"](#) on page 16.

### **TAP Instruction Set**

#### *Overview*

Eight different instructions are possible with the three bit instruction register. All combinations are listed in ["Identification Codes"](#) on page 16. Three of these instructions are listed as RESERVED and must not be used. The other five instructions are described in detail in this section.

Instructions are loaded into the TAP controller during the Shift-IR state when the instruction register is placed between TDI and TDO. During this state, instructions are shifted through the instruction register through the TDI and TDO balls. To execute the instruction once it is shifted in, the TAP controller must be moved into the Update-IR state.

#### *EXTEST*

The EXTEST instruction enables the preloaded data to be driven out through the system output pins. This instruction also selects the boundary scan register to be connected for serial access between the TDI and TDO in the Shift-DR controller state.

#### *IDCODE*

The IDCODE instruction causes a vendor-specific 32-bit code to be loaded into the instruction register. It also places the instruction register between the TDI and TDO balls and enables

the IDCODE to be shifted out of the device when the TAP controller enters the Shift-DR state.

The IDCODE instruction is loaded into the instruction register upon power up or whenever the TAP controller is given a test logic reset state.

#### *SAMPLE Z*

The SAMPLE Z instruction causes the boundary scan register to be connected between the TDI and TDO balls when the TAP controller is in a Shift-DR state. The SAMPLE Z command places all SRAM outputs into a High-Z state.

#### *SAMPLE/PRELOAD*

SAMPLE/PRELOAD is a 1149.1 mandatory instruction. When the SAMPLE/PRELOAD instructions are loaded into the instruction register and the TAP controller is in the Capture-DR state, a snapshot of data on the input and output pins is captured in the boundary scan register.

The TAP controller clock can only operate at a frequency up to 20 MHz, while the SRAM clock operates more than an order of magnitude faster. As there is a large difference in the clock frequencies, it is possible that during the Capture-DR state, an input or output undergoes a transition. The TAP may then try to capture a signal while in transition (metastable state). This does not harm the device, but there is no guarantee as to the value that is captured. Repeatable results may not be possible.

To guarantee that the boundary scan register captures the correct value of a signal, the SRAM signal must be stabilized long enough to meet the TAP controller's capture setup plus hold times ( $t_{CS}$  and  $t_{CH}$ ). The SRAM clock input might not be captured correctly if there is no way in a design to stop (or slow) the clock during a SAMPLE/PRELOAD instruction. If this is an issue, it is still possible to capture all other signals and simply ignore the value of the CK and CK# captured in the boundary scan register.

Once the data is captured, it is possible to shift out the data by putting the TAP into the Shift-DR state. This places the boundary scan register between the TDI and TDO pins.

PRELOAD enables an initial data pattern to be placed at the latched parallel outputs of the boundary scan register cells prior to the selection of another boundary scan test operation.

The shifting of data for the SAMPLE and PRELOAD phases can occur concurrently when required; that is, while data captured is shifted out, the preloaded data is shifted in.

#### *BYPASS*

When the BYPASS instruction is loaded in the instruction register and the TAP is placed in a Shift-DR state, the bypass register is placed between the TDI and TDO balls. The advantage of the BYPASS instruction is that it shortens the boundary scan path when multiple devices are connected together on a board.

#### *EXTEST Output Bus Tri-State*

IEEE Standard 1149.1 mandates that the TAP controller be able to put the output bus into a tri-state mode.

The boundary scan register has a special bit located at Bit #85 (for 119-BGA package) or Bit #89 (for 165-fBGA package). When this scan cell, called the "extest output bus tri-state," is latched into the preload register during the Update-DR state in the TAP controller, it directly controls the state of the output (Q-bus) pins,

when the EXTEST is entered as the current instruction. When HIGH, it enables the output buffers to drive the output bus. When LOW, this bit places the output bus into a High-Z condition.

This bit can be set by entering the SAMPLE/PRELOAD or EXTEST command, and then shifting the desired bit into that cell, during the Shift-DR state. During Update-DR, the value loaded into that shift-register cell latches into the preload register. When the EXTEST instruction is entered, this bit directly controls the

output Q-bus pins. Note that this bit is preset HIGH to enable the output when the device is powered up, and also when the TAP controller is in the Test-Logic-Reset state.

**Reserved**

These instructions are not implemented but are reserved for future use. Do not use these instructions.

**TAP Timing**

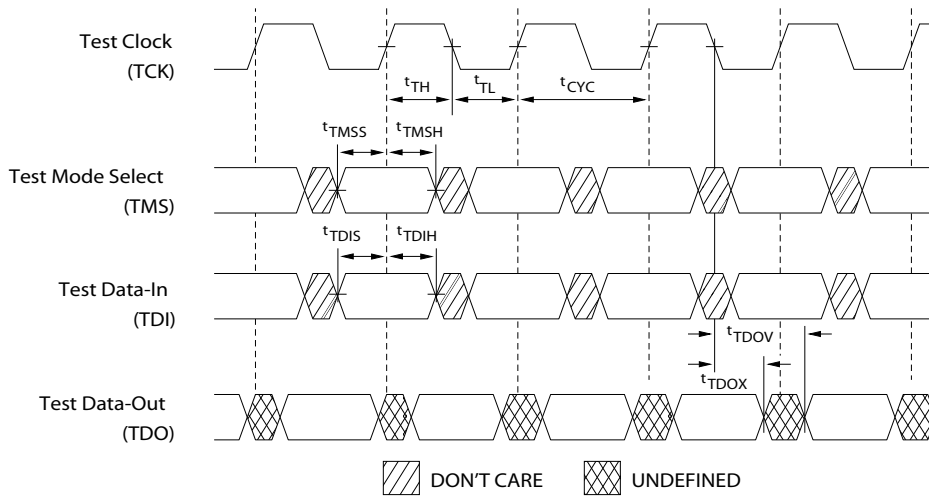

**TAP AC Switching Characteristics** Over the Operating Range [10, 11]

Parameter	Description	Min	Max	Unit
<b>Clock</b>				
t <sub>TCYC</sub>	TCK Clock Cycle Time	50		ns
t <sub>TF</sub>	TCK Clock Frequency		20	MHz
t <sub>TH</sub>	TCK Clock HIGH time	20		ns
t <sub>TL</sub>	TCK Clock LOW time	20		ns
<b>Output Times</b>				
t <sub>TDOV</sub>	TCK Clock LOW to TDO Valid		10	ns
t <sub>TDOX</sub>	TCK Clock LOW to TDO Invalid	0		ns
<b>Setup Times</b>				
t <sub>TMSS</sub>	TMS Setup to TCK Clock Rise	5		ns
t <sub>TDIS</sub>	TDI Setup to TCK Clock Rise	5		ns
t <sub>CS</sub>	Capture Setup to TCK Rise	5		ns
<b>Hold Times</b>				
t <sub>TMSH</sub>	TMS Hold after TCK Clock Rise	5		ns
t <sub>TDIH</sub>	TDI Hold after Clock Rise	5		ns
t <sub>CH</sub>	Capture Hold after Clock Rise	5		ns

**Notes**

- 10. t<sub>CS</sub> and t<sub>CH</sub> refer to the setup and hold time requirements of latching data from the boundary scan register.
- 11. Test conditions are specified using the load in TAP AC test conditions. t<sub>R</sub>/t<sub>F</sub> = 1ns.

### 3.3V TAP AC Test Conditions

Input pulse levels .....  $V_{SS}$  to 3.3V  
 Input rise and fall times ..... 1 ns  
 Input timing reference levels ..... 1.5V  
 Output reference levels ..... 1.5V  
 Test load termination supply voltage ..... 1.5V

**Figure 7. 3.3V TAP AC Output Load Equivalent**

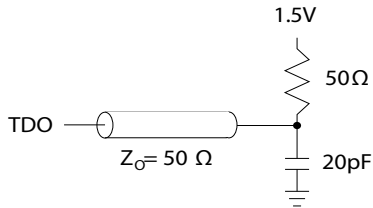

### 2.5V TAP AC Test Conditions

Input pulse levels .....  $V_{SS}$  to 2.5V  
 Input rise and fall time ..... 1 ns  
 Input timing reference levels ..... 1.25V  
 Output reference levels ..... 1.25V  
 Test load termination supply voltage ..... 1.25V

**Figure 8. 2.5V TAP AC Output Load Equivalent**

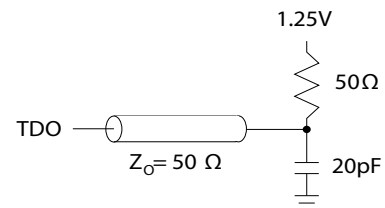

### TAP DC Electrical Characteristics And Operating Conditions

( $0^{\circ}\text{C} < T_A < +70^{\circ}\text{C}$ ;  $V_{DD} = 3.3\text{V} \pm 0.165\text{V}$  unless otherwise noted) <sup>[12]</sup>

Parameter	Description	Test Conditions	Min	Max	Unit
$V_{OH1}$	Output HIGH Voltage	$I_{OH} = -4.0\text{ mA}$ , $V_{DDQ} = 3.3\text{V}$	2.4		V
		$I_{OH} = -1.0\text{ mA}$ , $V_{DDQ} = 2.5\text{V}$	2.0		V
$V_{OH2}$	Output HIGH Voltage	$I_{OH} = -100\text{ }\mu\text{A}$	$V_{DDQ} = 3.3\text{V}$	2.9	V
			$V_{DDQ} = 2.5\text{V}$	2.1	V
$V_{OL1}$	Output LOW Voltage	$I_{OL} = 8.0\text{ mA}$	$V_{DDQ} = 3.3\text{V}$	0.4	V
			$V_{DDQ} = 2.5\text{V}$	0.4	V
$V_{OL2}$	Output LOW Voltage	$I_{OL} = 100\text{ }\mu\text{A}$	$V_{DDQ} = 3.3\text{V}$	0.2	V
			$V_{DDQ} = 2.5\text{V}$	0.2	V
$V_{IH}$	Input HIGH Voltage		$V_{DDQ} = 3.3\text{V}$	2.0	$V_{DD} + 0.3$
			$V_{DDQ} = 2.5\text{V}$	1.7	$V_{DD} + 0.3$
$V_{IL}$	Input LOW Voltage		$V_{DDQ} = 3.3\text{V}$	-0.3	0.8
			$V_{DDQ} = 2.5\text{V}$	-0.3	0.7
$I_X$	Input Load Current	$\text{GND} \leq V_{IN} \leq V_{DDQ}$	-5	5	$\mu\text{A}$

**Note**  
 12. All voltages referenced to  $V_{SS}$  (GND).



## Identification Register Definitions

Instruction Field	CY7C1380D/CY7C1380F (512K x 36)	CY7C1382D/CY7C1382F (1 Mbit x 18)	Description
Revision Number (31:29)	000	000	Describes the version number.
Device Depth (28:24) <sup>[13]</sup>	01011	01011	Reserved for internal use.
Device Width (23:18) 119-BGA	101000	101000	Defines the memory type and architecture.
Device Width (23:18) 165-FBGA	000000	000000	Defines the memory type and architecture.
Cypress Device ID (17:12)	100101	010101	Defines the width and density.
Cypress JEDEC ID Code (11:1)	00000110100	00000110100	Allows unique identification of SRAM vendor.
ID Register Presence Indicator (0)	1	1	Indicates the presence of an ID register.

## Scan Register Sizes

Register Name	Bit Size (x36)	Bit Size (x18)
Instruction	3	3
Bypass	1	1
ID	32	32
Boundary Scan Order (119-ball BGA package)	85	85
Boundary Scan Order (165-ball FBGA package)	89	89

## Identification Codes

Instruction	Code	Description
EXTEST	000	Captures I/O ring contents. Places the boundary scan register between TDI and TDO. Forces all SRAM outputs to High-Z state.
IDCODE	001	Loads the ID register with the vendor ID code and places the register between TDI and TDO. This operation does not affect SRAM operations.
SAMPLE Z	010	Captures I/O ring contents. Places the boundary scan register between TDI and TDO. Forces all SRAM output drivers to a High-Z state.
RESERVED	011	Do Not Use. This instruction is reserved for future use.
SAMPLE/PRELOAD	100	Captures I/O ring contents. Places the boundary scan register between TDI and TDO. Does not affect SRAM operation.
RESERVED	101	Do Not Use. This instruction is reserved for future use.
RESERVED	110	Do Not Use. This instruction is reserved for future use.
BYPASS	111	Places the bypass register between TDI and TDO. This operation does not affect SRAM operations.

**Note**

13. Bit #24 is 1 in the register definitions for both 2.5v and 3.3v versions of this device.

**119-Ball BGA Boundary Scan Order** <sup>[14, 15]</sup>

Bit #	Ball ID	Bit #	Ball ID	Bit #	Ball ID	Bit #	Ball ID
1	H4	23	F6	45	G4	67	L1
2	T4	24	E7	46	A4	68	M2
3	T5	25	D7	47	G3	69	N1
4	T6	26	H7	48	C3	70	P1
5	R5	27	G6	49	B2	71	K1
6	L5	28	E6	50	B3	72	L2
7	R6	29	D6	51	A3	73	N2
8	U6	30	C7	52	C2	74	P2
9	R7	31	B7	53	A2	75	R3
10	T7	32	C6	54	B1	76	T1
11	P6	33	A6	55	C1	77	R1
12	N7	34	C5	56	D2	78	T2
13	M6	35	B5	57	E1	79	L3
14	L7	36	G5	58	F2	80	R2
15	K6	37	B6	59	G1	81	T3
16	P7	38	D4	60	H2	82	L4
17	N6	39	B4	61	D1	83	N4
18	L6	40	F4	62	E2	84	P4
19	K7	41	M4	63	G2	85	Internal
20	J5	42	A5	64	H1		
21	H6	43	K4	65	J3		
22	G7	44	E4	66	2K		

**Notes**

- 14. Balls which are NC (No Connect) are pre-set LOW.
- 15. Bit# 85 is pre-set HIGH.

**165-Ball BGA Boundary Scan Order** <sup>[14, 16]</sup>

Bit #	Ball ID
1	N6
2	N7
3	N10
4	P11
5	P8
6	R8
7	R9
8	P9
9	P10
10	R10
11	R11
12	H11
13	N11
14	M11
15	L11
16	K11
17	J11
18	M10
19	L10
20	K10
21	J10
22	H9
23	H10
24	G11
25	F11
26	E11
27	D11
28	G10
29	F10
30	E10

Bit #	Ball ID
31	D10
32	C11
33	A11
34	B11
35	A10
36	B10
37	A9
38	B9
39	C10
40	A8
41	B8
42	A7
43	B7
44	B6
45	A6
46	B5
47	A5
48	A4
49	B4
50	B3
51	A3
52	A2
53	B2
54	C2
55	B1
56	A1
57	C1
58	D1
59	E1
60	F1

Bit #	Ball ID
61	G1
62	D2
63	E2
64	F2
65	G2
66	H1
67	H3
68	J1
69	K1
70	L1
71	M1
72	J2
73	K2
74	L2
75	M2
76	N1
77	N2
78	P1
79	R1
80	R2
81	P3
82	R3
83	P2
84	R4
85	P4
86	N5
87	P6
88	R6
89	Internal

**Note**  
16. Bit# 89 is pre-set HIGH.

## Maximum Ratings

Exceeding the maximum ratings may impair the useful life of the device. For user guidelines, not tested.

Storage Temperature .....	-65°C to +150°C
Ambient Temperature with Power Applied .....	-55°C to +125°C
Supply Voltage on V <sub>DD</sub> Relative to GND .....	-0.3V to +4.6V
Supply Voltage on V <sub>DDQ</sub> Relative to GND .....	-0.3V to +V <sub>DD</sub>
DC Voltage Applied to Outputs in Tri-State .....	-0.5V to V <sub>DDQ</sub> + 0.5V

DC Input Voltage .....	-0.5V to V <sub>DD</sub> + 0.5V
Current into Outputs (LOW).....	20 mA
Static Discharge Voltage.....	>2001V (per MIL-STD-883, Method 3015)
Latch-up Current.....	>200 mA

## Operating Range

Range	Ambient Temperature	V <sub>DD</sub>	V <sub>DDQ</sub>
Commercial	0°C to +70°C	3.3V -5%/+10%	2.5V - 5% to V <sub>DD</sub>
Industrial	-40°C to +85°C		

## Electrical Characteristics Over the Operating Range <sup>[17, 18]</sup>

Parameter	Description	Test Conditions	Min	Max	Unit
V <sub>DD</sub>	Power Supply Voltage		3.135	3.6	V
V <sub>DDQ</sub>	I/O Supply Voltage	for 3.3V I/O	3.135	V <sub>DD</sub>	V
		for 2.5V I/O	2.375	2.625	V
V <sub>OH</sub>	Output HIGH Voltage	for 3.3V I/O, I <sub>OH</sub> = -4.0 mA	2.4		V
		for 2.5V I/O, I <sub>OH</sub> = -1.0 mA	2.0		V
V <sub>OL</sub>	Output LOW Voltage	for 3.3V I/O, I <sub>OL</sub> = 8.0 mA		0.4	V
		for 2.5V I/O, I <sub>OL</sub> = 1.0 mA		0.4	V
V <sub>IH</sub>	Input HIGH Voltage <sup>[17]</sup>	for 3.3V I/O	2.0	V <sub>DD</sub> + 0.3V	V
		for 2.5V I/O	1.7	V <sub>DD</sub> + 0.3V	V
V <sub>IL</sub>	Input LOW Voltage <sup>[17]</sup>	for 3.3V I/O	-0.3	0.8	V
		for 2.5V I/O	-0.3	0.7	V
I <sub>X</sub>	Input Leakage Current except ZZ and MODE	GND ≤ V <sub>I</sub> ≤ V <sub>DDQ</sub>	-5	5	μA
	Input Current of MODE	Input = V <sub>SS</sub>	-30		μA
		Input = V <sub>DD</sub>		5	μA
	Input Current of ZZ	Input = V <sub>SS</sub>	-5		μA
Input = V <sub>DD</sub>			30	μA	
I <sub>OZ</sub>	Output Leakage Current	GND ≤ V <sub>I</sub> ≤ V <sub>DDQ</sub> , Output Disabled	-5	5	μA
I <sub>DD</sub>	V <sub>DD</sub> Operating Supply Current	V <sub>DD</sub> = Max., I <sub>OUT</sub> = 0 mA, f = f <sub>MAX</sub> = 1/t <sub>CYC</sub>	4.0-ns cycle, 250 MHz	350	mA
			5.0-ns cycle, 200 MHz	300	mA
			6.0-ns cycle, 167 MHz	275	mA
I <sub>SB1</sub>	Automatic CE Power Down Current—TTL Inputs	V <sub>DD</sub> = Max, Device Deselected, V <sub>IN</sub> ≥ V <sub>IH</sub> or V <sub>IN</sub> ≤ V <sub>IL</sub> , f = f <sub>MAX</sub> = 1/t <sub>CYC</sub>	4.0-ns cycle, 250 MHz	160	mA
			5.0-ns cycle, 200 MHz	150	mA
			6.0-ns cycle, 167 MHz	140	mA
I <sub>SB2</sub>	Automatic CE Power Down Current—CMOS Inputs	V <sub>DD</sub> = Max, Device Deselected, V <sub>IN</sub> ≤ 0.3V or V <sub>IN</sub> ≥ V <sub>DDQ</sub> - 0.3V, f = 0	All speeds	70	mA
I <sub>SB3</sub>	Automatic CE Power Down Current—CMOS Inputs	V <sub>DD</sub> = Max, Device Deselected, or V <sub>IN</sub> ≤ 0.3V or V <sub>IN</sub> ≥ V <sub>DDQ</sub> - 0.3V, f = f <sub>MAX</sub> = 1/t <sub>CYC</sub>	4.0-ns cycle, 250 MHz	135	mA
			5.0-ns cycle, 200 MHz	130	mA
			6.0-ns cycle, 167 MHz	125	mA
I <sub>SB4</sub>	Automatic CE Power Down Current—TTL Inputs	V <sub>DD</sub> = Max, Device Deselected, V <sub>IN</sub> ≥ V <sub>IH</sub> or V <sub>IN</sub> ≤ V <sub>IL</sub> , f = 0	All speeds	80	mA

### Notes

17. Overshoot: V<sub>IH</sub>(AC) < V<sub>DD</sub> + 1.5V (pulse width less than t<sub>CYC</sub>/2), undershoot: V<sub>IL</sub>(AC) > -2V (pulse width less than t<sub>CYC</sub>/2).  
 18. TPower up: Assumes a linear ramp from 0v to V<sub>DD</sub>(min.) within 200 ms. During this time V<sub>IH</sub> < V<sub>DD</sub> and V<sub>DDQ</sub> ≤ V<sub>DD</sub>.

**Capacitance** <sup>[19]</sup>

Parameter	Description	Test Conditions	100 TQFP Package	119 BGA Package	165 FBGA Package	Unit
C <sub>IN</sub>	Input Capacitance	T <sub>A</sub> = 25°C, f = 1 MHz, V <sub>DD</sub> = 3.3V, V <sub>DDQ</sub> = 2.5V	5	8	9	pF
C <sub>CLK</sub>	Clock Input Capacitance		5	8	9	pF
C <sub>IO</sub>	Input/Output Capacitance		5	8	9	pF

**Thermal Resistance** <sup>[19]</sup>

Parameter	Description	Test Conditions	100 TQFP Package	119 BGA Package	165 FBGA Package	Unit
θ <sub>JA</sub>	Thermal Resistance (Junction to Ambient)	Test conditions follow standard test methods and procedures for measuring thermal impedance, in accordance with EIA/JESD51.	28.66	23.8	20.7	°C/W
θ <sub>JC</sub>	Thermal Resistance (Junction to Case)		4.08	6.2	4.0	°C/W

**Figure 9. AC Test Loads and Waveforms**

**3.3V I/O Test Load**

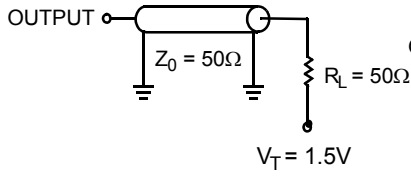

(a)

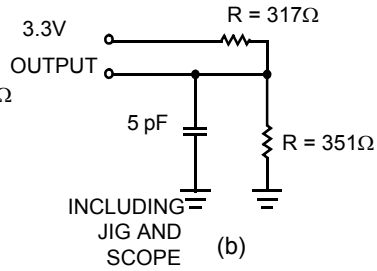

(b)

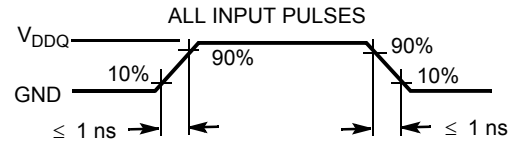

(c)

**2.5V I/O Test Load**

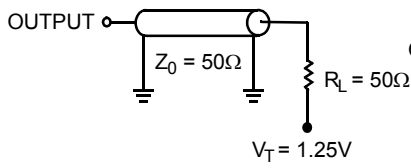

(a)

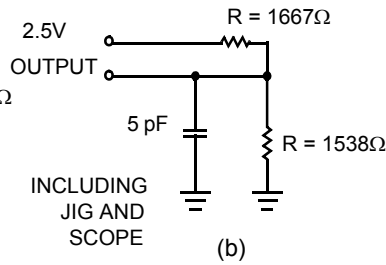

(b)

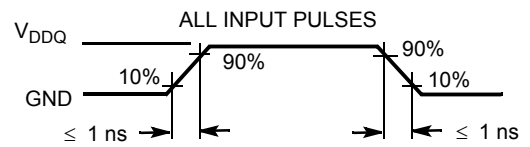

(c)

**Note**

19. Tested initially and after any design or process change that may affect these parameters.

**Switching Characteristics** Over the Operating Range [20, 21]

Parameter	Description	250 MHz		200 MHz		167 MHz		Unit
		Min	Max	Min	Max	Min	Max	
t <sub>POWER</sub>	V <sub>DD</sub> (Typical) to the first Access [22]	1		1		1		ms
<b>Clock</b>								
t <sub>CYC</sub>	Clock Cycle Time	4.0		5		6		ns
t <sub>CH</sub>	Clock HIGH	1.7		2.0		2.2		ns
t <sub>CL</sub>	Clock LOW	1.7		2.0		2.2		ns
<b>Output Times</b>								
t <sub>CO</sub>	Data Output Valid After CLK Rise		2.6		3.0		3.4	ns
t <sub>DOH</sub>	Data Output Hold After CLK Rise	1.0		1.3		1.3		ns
t <sub>CLZ</sub>	Clock to Low-Z [23, 24, 25]	1.0		1.3		1.3		ns
t <sub>CHZ</sub>	Clock to High-Z [23, 24, 25]		2.6		3.0		3.4	ns
t <sub>OEV</sub>	OE LOW to Output Valid		2.6		3.0		3.4	ns
t <sub>OELZ</sub>	OE LOW to Output Low-Z [23, 24, 25]	0		0		0		ns
t <sub>OEHZ</sub>	OE HIGH to Output High-Z [23, 24, 25]		2.6		3.0		3.4	ns
<b>Setup Times</b>								
t <sub>AS</sub>	Address Setup Before CLK Rise	1.2		1.4		1.5		ns
t <sub>ADS</sub>	ADSC, ADSP Setup Before CLK Rise	1.2		1.4		1.5		ns
t <sub>ADVS</sub>	ADV Setup Before CLK Rise	1.2		1.4		1.5		ns
t <sub>WES</sub>	GW, BWE, BW <sub>X</sub> Setup Before CLK Rise	1.2		1.4		1.5		ns
t <sub>DS</sub>	Data Input Setup Before CLK Rise	1.2		1.4		1.5		ns
t <sub>CES</sub>	Chip Enable SetUp Before CLK Rise	1.2		1.4		1.5		ns
<b>Hold Times</b>								
t <sub>AH</sub>	Address Hold After CLK Rise	0.3		0.4		0.5		ns
t <sub>ADH</sub>	ADSP, ADSC Hold After CLK Rise	0.3		0.4		0.5		ns
t <sub>ADVH</sub>	ADV Hold After CLK Rise	0.3		0.4		0.5		ns
t <sub>WEH</sub>	GW, BWE, BW <sub>X</sub> Hold After CLK Rise	0.3		0.4		0.5		ns
t <sub>DH</sub>	Data Input Hold After CLK Rise	0.3		0.4		0.5		ns
t <sub>CEH</sub>	Chip Enable Hold After CLK Rise	0.3		0.4		0.5		ns

**Notes**

20. Timing reference level is 1.5V when V<sub>DDQ</sub> = 3.3V and is 1.25V when V<sub>DDQ</sub> = 2.5V.

21. Test conditions shown in (a) of AC Test Loads unless otherwise noted.

22. This part has a voltage regulator internally; t<sub>POWER</sub> is the time that the power needs to be supplied above V<sub>DD</sub>(minimum) initially before a read or write operation can be initiated.

23. t<sub>CHZ</sub>, t<sub>CLZ</sub>, t<sub>OELZ</sub>, and t<sub>OEHZ</sub> are specified with AC test conditions shown in part (b) of "AC Test Loads and Waveforms" on page 21. Transition is measured ± 200 mV from steady-state voltage.

24. At any given voltage and temperature, t<sub>OEHZ</sub> is less than t<sub>OELZ</sub> and t<sub>CHZ</sub> is less than t<sub>CLZ</sub> to eliminate bus contention between SRAMs when sharing the same data bus. These specifications do not imply a bus contention condition, but reflect parameters guaranteed over worst case user conditions. Device is designed to achieve High-Z prior to Low-Z under the same system conditions.

25. This parameter is sampled and not 100% tested.



## Switching Waveforms

Figure 10. Read Cycle Timing [26]

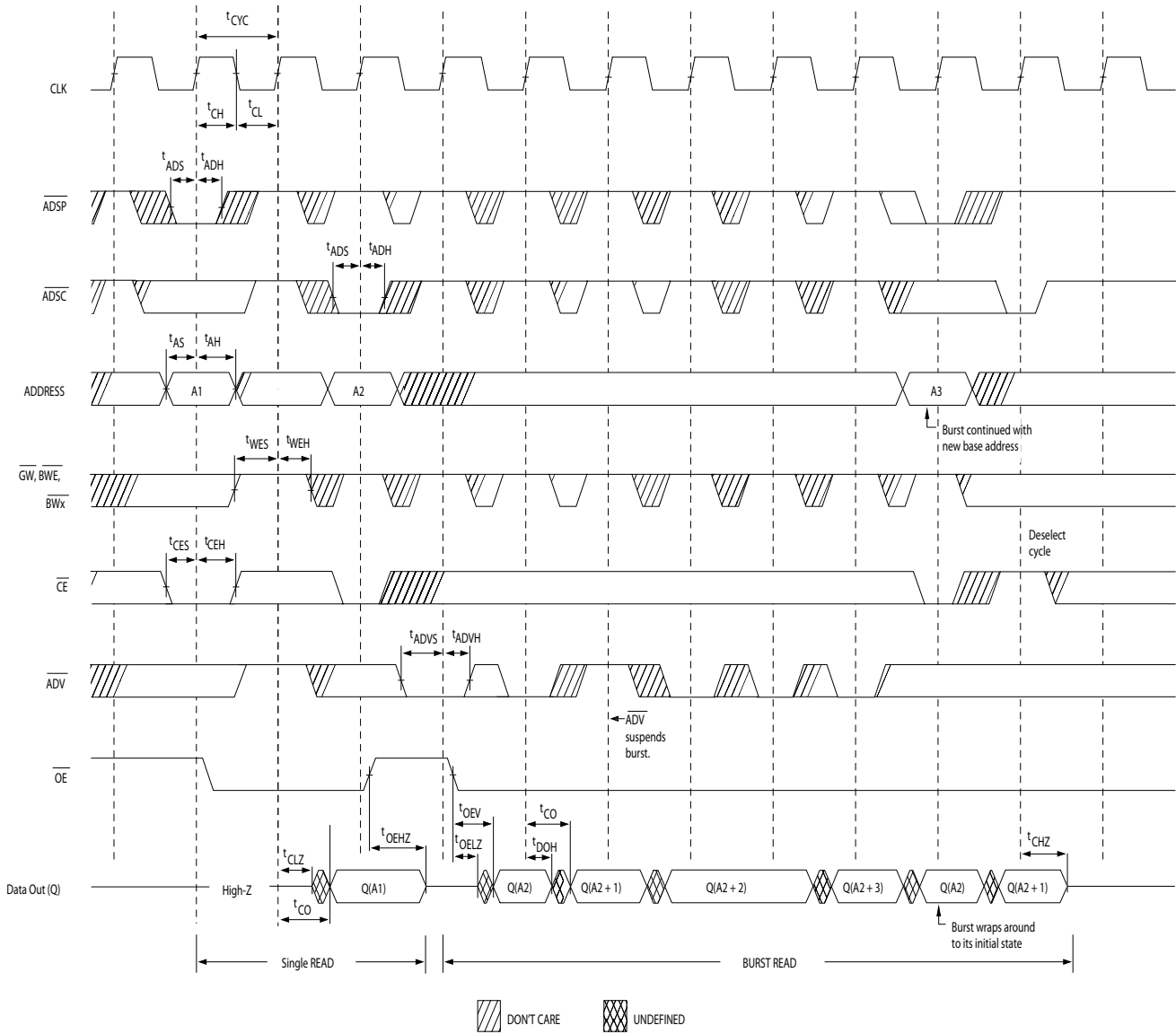

**Note**

26. On this diagram, when  $\overline{CE}$  is LOW:  $\overline{CE}_1$  is LOW,  $CE_2$  is HIGH and  $\overline{CE}_3$  is LOW. When  $\overline{CE}$  is HIGH:  $\overline{CE}_1$  is HIGH or  $CE_2$  is LOW or  $\overline{CE}_3$  is HIGH.

Switching Waveforms (continued)

Figure 11. Write Cycle Timing [26, 27]

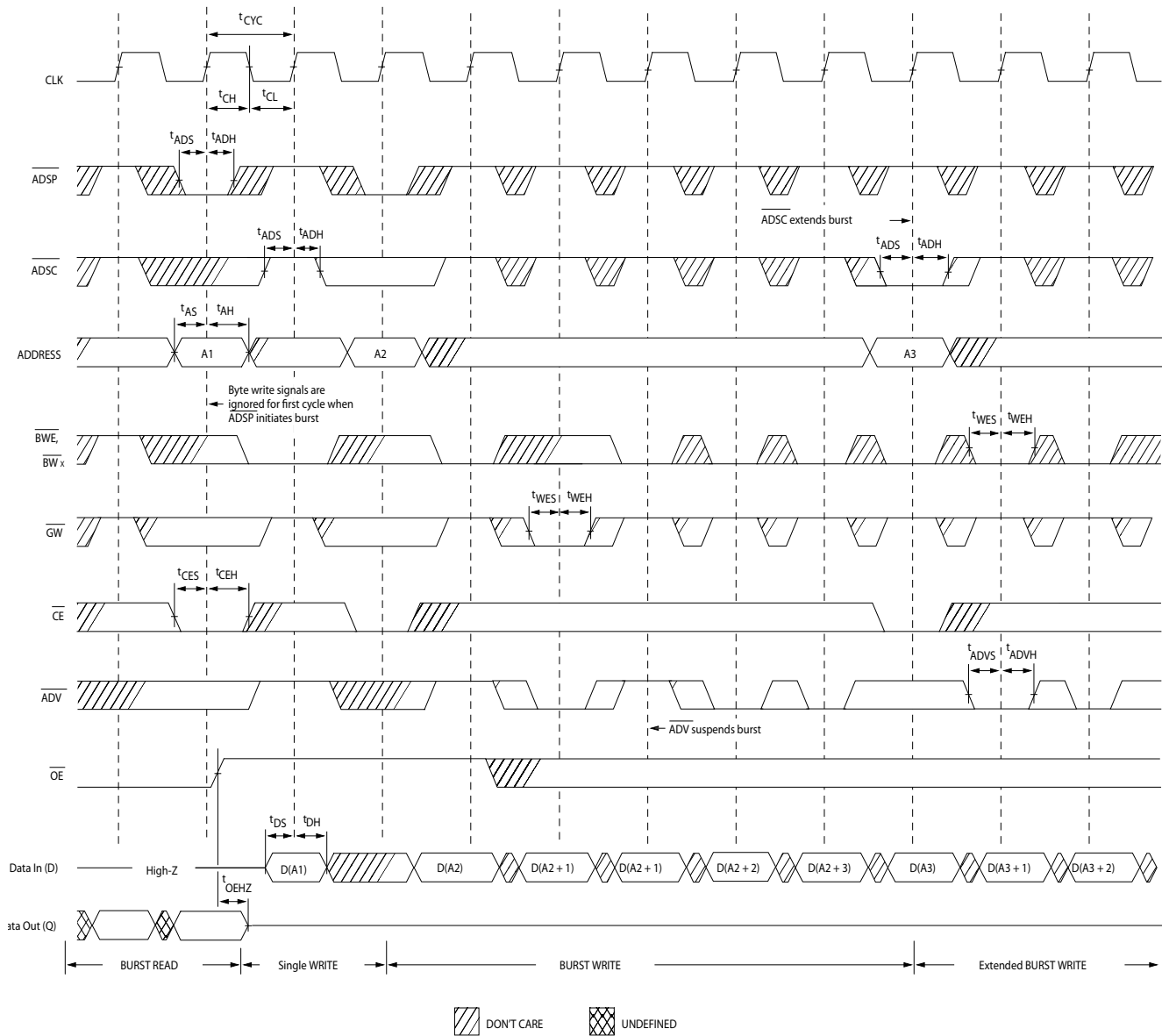

Note

27. Full width write can be initiated by either  $\overline{GW}$  LOW; or by  $\overline{GW}$  HIGH,  $\overline{BWE}$  LOW and  $\overline{BW}_x$  LOW.

**Switching Waveforms** (continued)

**Figure 12. Read/Write Cycle Timing** [26, 28, 29]

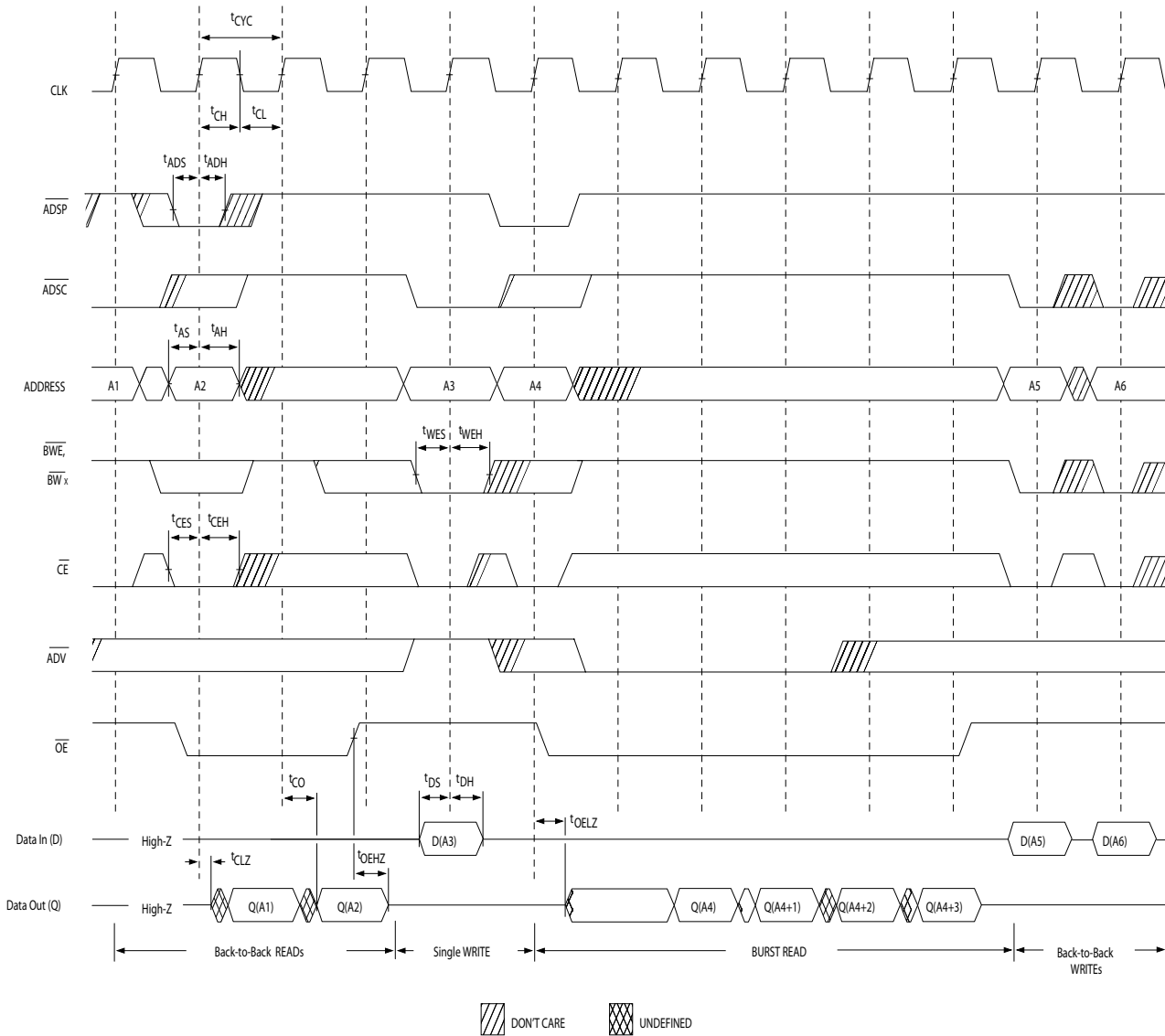

**Notes**

- 28. The data bus (Q) remains in high-Z following a WRITE cycle, unless a new read access is initiated by  $\overline{ADSP}$  or  $\overline{ADSC}$ .
- 29. GW is HIGH.

Switching Waveforms (continued)

Figure 13. ZZ Mode Timing [30, 31]

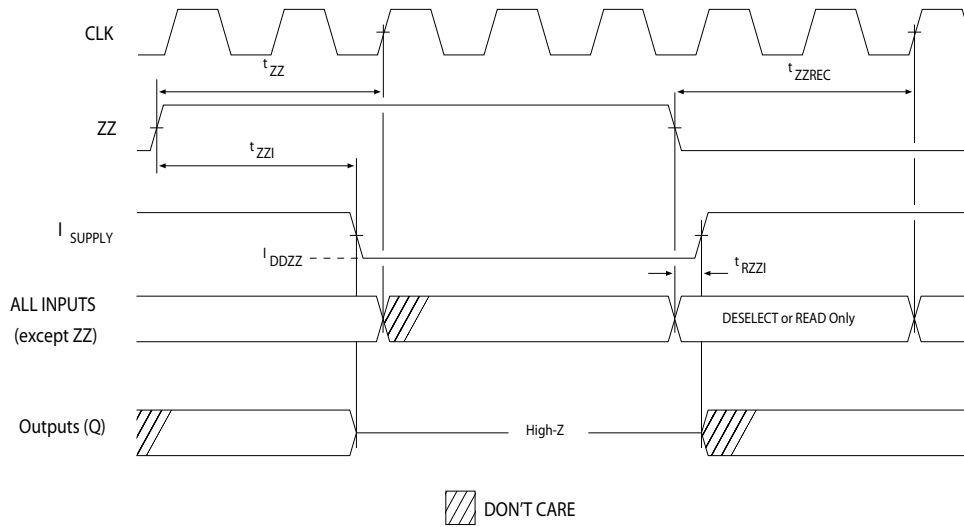

Notes

- 30. Device must be deselected when entering ZZ mode. See "Truth Table" on page 10 for all possible signal conditions to deselect the device.
- 31. DQs are in high-Z when exiting ZZ sleep mode.

## Ordering Information

The following table lists all speed, package and temperature range options. Please note that some options listed below may not be available for order entry. To verify the availability of a specific option, visit the Cypress website at [www.cypress.com](http://www.cypress.com) and refer to the product summary page at <http://www.cypress.com/products>, or contact your local sales representative for the status of availability of parts.

Cypress maintains a worldwide network of offices, solution centers, manufacturer's representatives and distributors. To find the office closest to you, visit us at <http://app.cypress.com/portal/server.pt?space=CommunityPage&control=SetCommunity&CommunityID=201&PageID=230>.

Speed (MHz)	Ordering Code	Package Diagram	Part and Package Type	Operating Range	
250	CY7C1380D-250AXC	51-85050	100-pin Thin Quad Flat Pack (14 x 20 x 1.4 mm) Pb-Free	Commercial	
	CY7C1382D-250AXC				
	CY7C1380F-250AXC				
	CY7C1382F-250AXC				
	CY7C1380F-250BGC	51-85115	119-ball Ball Grid Array (14 x 22 x 2.4 mm)		
	CY7C1382F-250BGC				
	CY7C1380F-250BGXC	51-85115	119-ball Ball Grid Array (14 x 22 x 2.4 mm) Pb-Free		
	CY7C1382F-250BGXC				
	CY7C1380D-250BZC	51-85180	165-ball Fine-Pitch Ball Grid Array (13 x 15 x 1.4 mm)		
	CY7C1382D-250BZC				
	CY7C1380F-250BZC				
	CY7C1382F-250BZC				
	CY7C1380D-250BZXC	51-85180	165-ball Fine-Pitch Ball Grid Array (13 x 15 x 1.4 mm) Pb-Free		
	CY7C1382D-250BZXC				
	CY7C1380F-250BZXC				
	CY7C1382F-250BZXC				
	CY7C1380D-250AXI	51-85050	100-pin Thin Quad Flat Pack (14 x 20 x 1.4 mm) Pb-Free		Industrial
	CY7C1382D-250AXI				
	CY7C1380F-250AXI				
	CY7C1382F-250AXI				
CY7C1380F-250BGI	51-85115	119-ball Ball Grid Array (14 x 22 x 2.4 mm)			
CY7C1382F-250BGI					
CY7C1380F-250BGXI	51-85115	119-ball Ball Grid Array (14 x 22 x 2.4 mm) Pb-Free			
CY7C1382F-250BGXI					
CY7C1380D-250BZI	51-85180	165-ball Fine-Pitch Ball Grid Array (13 x 15 x 1.4 mm)			
CY7C1382D-250BZI					
CY7C1380F-250BZI					
CY7C1382F-250BZI					
CY7C1380D-250BZXI	51-85180	165-ball Fine-Pitch Ball Grid Array (13 x 15 x 1.4 mm) Pb-Free			
CY7C1382D-250BZXI					
CY7C1380F-250BZXI					
CY7C1382F-250BZXI					

Speed (MHz)	Ordering Code	Package Diagram	Part and Package Type	Operating Range
200	CY7C1380D-200AXC	51-85050	100-pin Thin Quad Flat Pack (14 x 20 x 1.4 mm) Pb-Free	Commercial
	CY7C1382D-200AXC			
	CY7C1380F-200AXC			
	CY7C1382F-200AXC			
	CY7C1380F-200BGC	51-85115	119-ball Ball Grid Array (14 x 22 x 2.4 mm)	
	CY7C1382F-200BGC			
	CY7C1380F-200BGXC	51-85115	119-ball Ball Grid Array (14 x 22 x 2.4 mm) Pb-Free	
	CY7C1382F-200BGXC			
	CY7C1380D-200BZC	51-85180	165-ball Fine-Pitch Ball Grid Array (13 x 15 x 1.4 mm)	
	CY7C1382D-200BZC			
	CY7C1380F-200BZC			
	CY7C1382F-200BZC			
	CY7C1380D-200BZXC	51-85180	165-ball Fine-Pitch Ball Grid Array (13 x 15 x 1.4 mm) Pb-Free	
	CY7C1382D-200BZXC			
	CY7C1380F-200BZXC			
	CY7C1382F-200BZXC			
CY7C1380D-200AXI	51-85050	100-pin Thin Quad Flat Pack (14 x 20 x 1.4 mm) Pb-Free	Industrial	
CY7C1382D-200AXI				
CY7C1380F-200AXI				
CY7C1382F-200AXI				
CY7C1380F-200BGI	51-85115	119-ball Ball Grid Array (14 x 22 x 2.4 mm)		
CY7C1382F-200BGI				
CY7C1380F-200BGXI	51-85115	119-ball Ball Grid Array (14 x 22 x 2.4 mm) Pb-Free		
CY7C1382F-200BGXI				
CY7C1380D-200BZI	51-85180	165-ball Fine-Pitch Ball Grid Array (13 x 15 x 1.4 mm)		
CY7C1382D-200BZI				
CY7C1380F-200BZI				
CY7C1382F-200BZI				
CY7C1380D-200BZXI	51-85180	165-ball Fine-Pitch Ball Grid Array (13 x 15 x 1.4 mm) Pb-Free		
CY7C1382D-200BZXI				
CY7C1380F-200BZXI				
CY7C1382F-200BZXI				

Speed (MHz)	Ordering Code	Package Diagram	Part and Package Type	Operating Range
167	CY7C1380D-167AXC	51-85050	100-pin Thin Quad Flat Pack (14 x 20 x 1.4 mm) Pb-Free	Commercial
	CY7C1382D-167AXC			
	CY7C1380F-167AXC			
	CY7C1382F-167AXC			
	CY7C1380F-167BGC	51-85115	119-ball Ball Grid Array (14 x 22 x 2.4 mm)	
	CY7C1382F-167BGC			
	CY7C1380F-167BGXC	51-85115	119-ball Ball Grid Array (14 x 22 x 2.4 mm) Pb-Free	
	CY7C1382F-167BGXC			
	CY7C1380D-167BZC	51-85180	165-ball Fine-Pitch Ball Grid Array (13 x 15 x 1.4 mm)	
	CY7C1382D-167BZC			
	CY7C1380F-167BZC			
	CY7C1382F-167BZC			
	CY7C1380D-167BZXC	51-85180	165-ball Fine-Pitch Ball Grid Array (13 x 15 x 1.4 mm) Pb-Free	
	CY7C1382D-167BZXC			
	CY7C1380F-167BZXC			
	CY7C1382F-167BZXC			
CY7C1380D-167AXI	51-85050	100-pin Thin Quad Flat Pack (14 x 20 x 1.4 mm) Pb-Free	Industrial	
CY7C1382D-167AXI				
CY7C1380F-167AXI				
CY7C1382F-167AXI				
CY7C1380F-167BGI	51-85115	119-ball Ball Grid Array (14 x 22 x 2.4 mm)		
CY7C1382F-167BGI				
CY7C1380F-167BGXI	51-85115	119-ball Ball Grid Array (14 x 22 x 2.4 mm) Pb-Free		
CY7C1382F-167BGXI				
CY7C1380D-167BZI	51-85180	165-ball Fine-Pitch Ball Grid Array (13 x 15 x 1.4 mm)		
CY7C1382D-167BZI				
CY7C1380F-167BZI				
CY7C1382F-167BZI				
CY7C1380D-167BZXI	51-85180	165-ball Fine-Pitch Ball Grid Array (13 x 15 x 1.4 mm) Pb-Free		
CY7C1382D-167BZXI				
CY7C1380F-167BZXI				
CY7C1382F-167BZXI				



**Package Diagrams**

**Figure 14. 100-Pin Thin Plastic Quad Flat Pack (14 x 20 x 1.4 mm) (51-85050)**

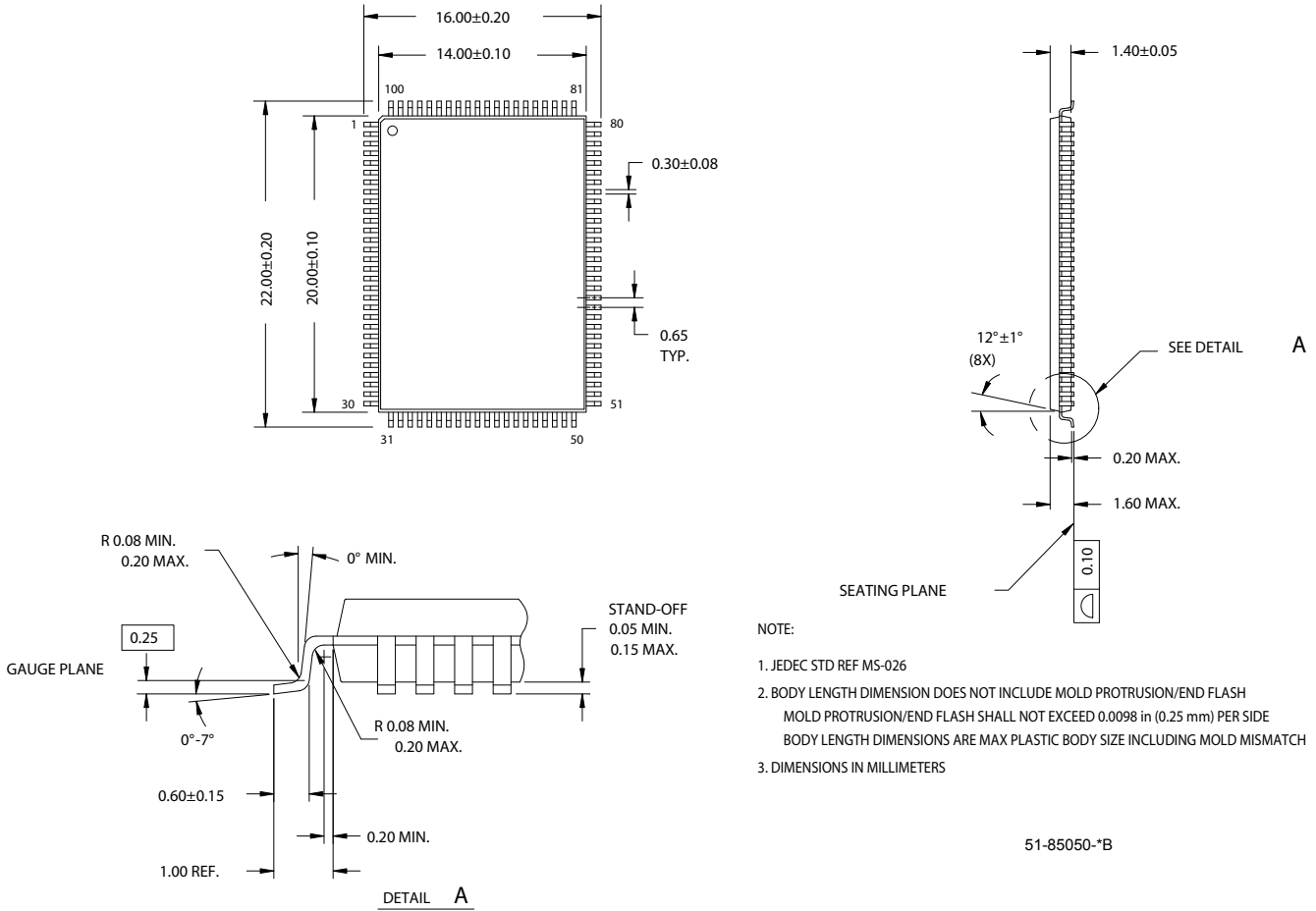

**Package Diagrams** (continued)

**Figure 15. 119-Ball BGA (14 x 22 x 2.4 mm) (51-85115)**

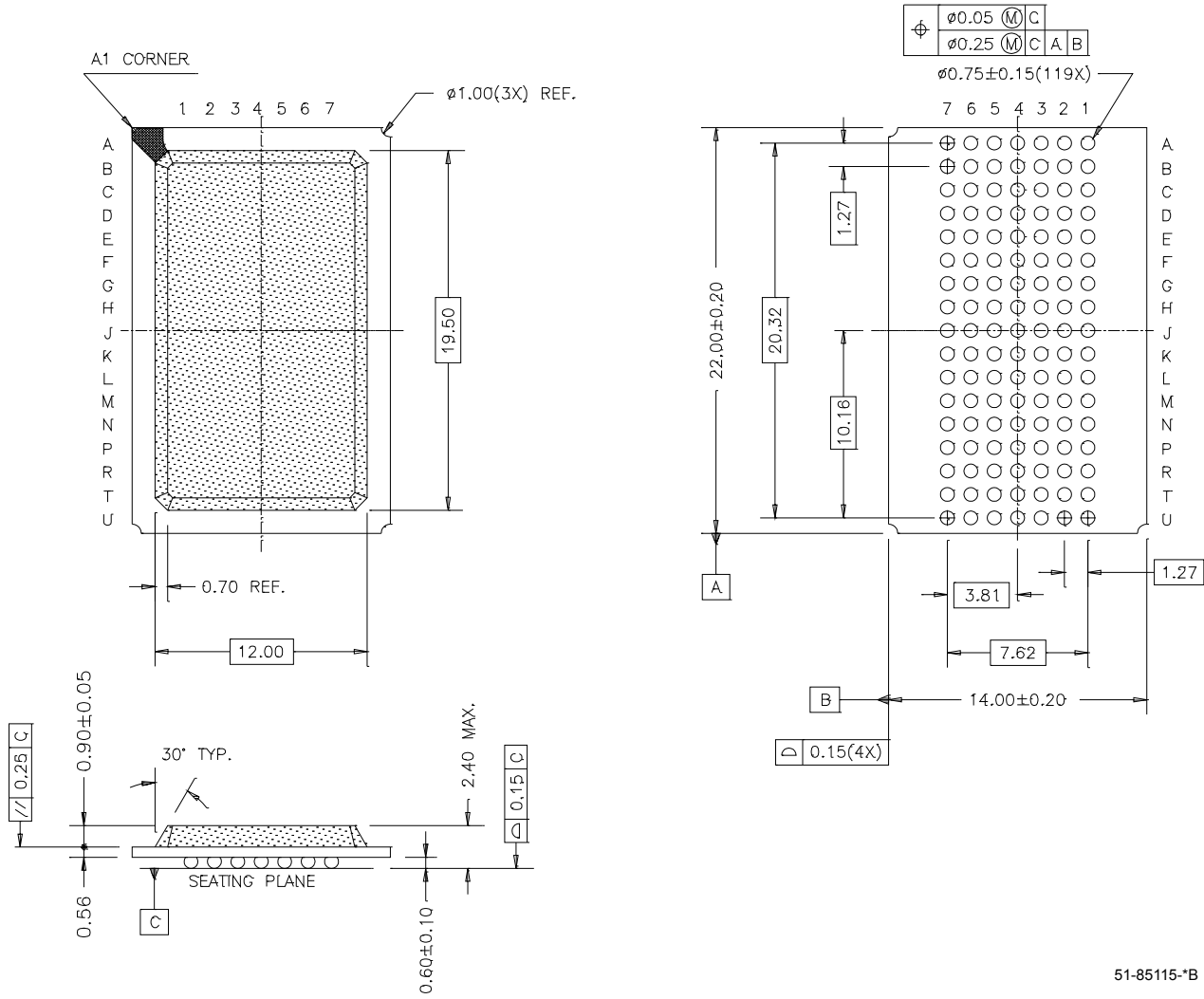

51-85115-\*B

**Package Diagrams** (continued)

**Figure 16. 165-Ball FBGA (13 x 15 x 1.4 mm) (51-85180)**

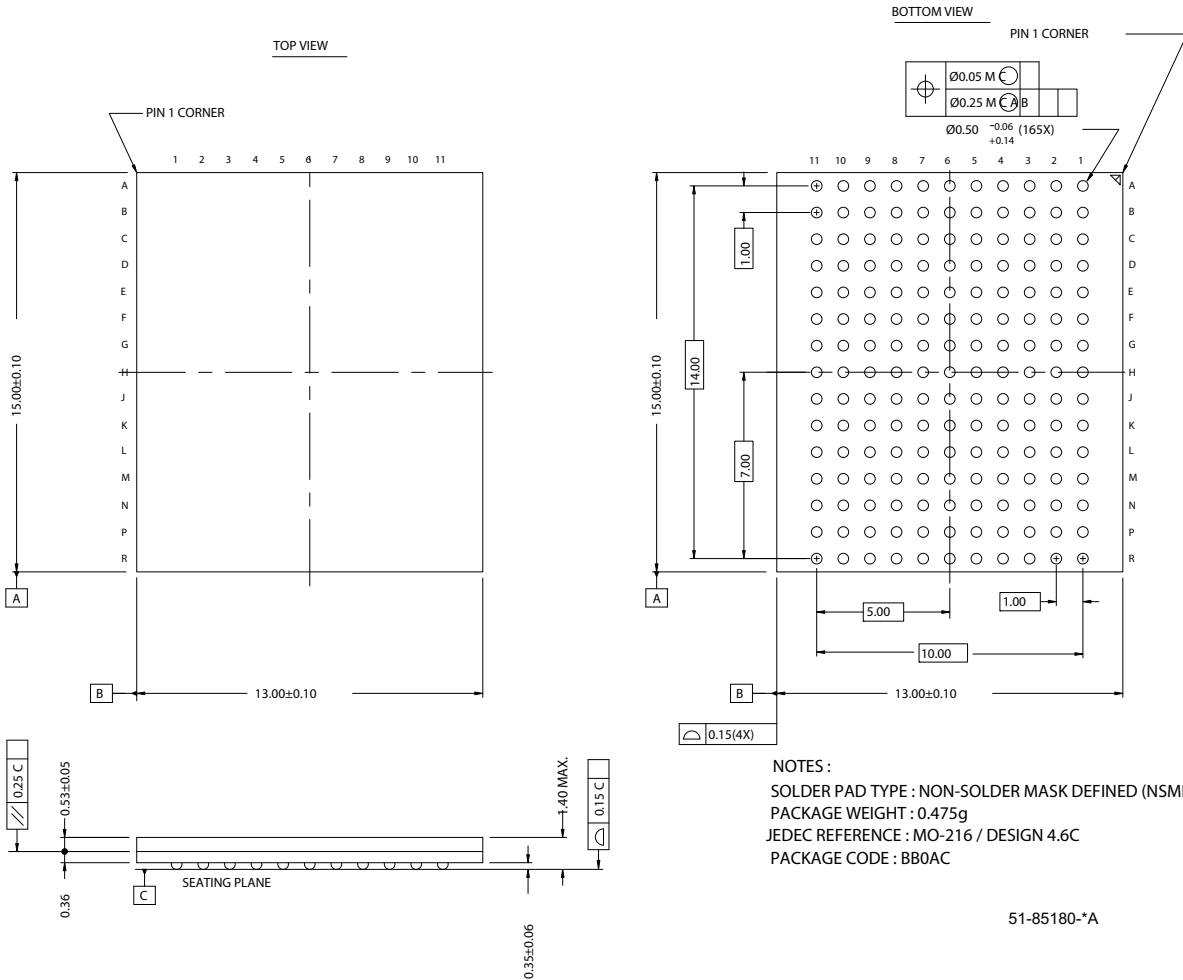

## Document History Page

Document Title: CY7C1380D/CY7C1382D/CY7C1380F/CY7C1382F, 18-Mbit (512K x 36/1M x 18) Pipelined SRAM Document Number: 38-05543				
REV.	ECN NO.	Submission Date	Orig. of Change	Description of Change
**	254515	See ECN	RKF	New data sheet
*A	288531	See ECN	SYT	Edited description under "IEEE 1149.1 Serial Boundary Scan (JTAG)" for non-compliance with 1149.1 Removed 225MHz and 133 MHz Speed Bins Added Pb-free information for 100-Pin TQFP, 119 BGA and 165 FBGA Packages Added comment of 'Pb-free BG packages availability' below the Ordering Information
*B	326078	See ECN	PCI	Address expansion pins/balls in the pinouts for all packages are modified as per JEDEC standard Added description on EXTEST Output Bus Tri-State Changed description on the Tap Instruction Set Overview and Extest Changed Device Width (23:18) for 119-BGA from 000000 to 101000 Added separate row for 165 -FBGA Device Width (23:18) Changed $\Theta_{JA}$ and $\Theta_{JC}$ for TQFP Package from 31 and 6 °C/W to 28.66 and 4.08 °C/W respectively Changed $\Theta_{JA}$ and $\Theta_{JC}$ for BGA Package from 45 and 7 °C/W to 23.8 and 6.2 °C/W respectively Changed $\Theta_{JA}$ and $\Theta_{JC}$ for FBGA Package from 46 and 3 °C/W to 20.7 and 4.0 °C/W respectively Modified $V_{OL}$ , $V_{OH}$ test conditions Removed comment of 'Pb-free BG packages availability' below the Ordering Information Updated Ordering Information Table
*C	416321	See ECN	NXR	Converted from Preliminary to Final Changed address of Cypress Semiconductor Corporation on Page# 1 from "3901 North First Street" to "198 Champion Court" Changed the description of $I_X$ from Input Load Current to Input Leakage Current on page# 18 Changed the $I_X$ current values of MODE on page # 18 from -5 $\mu$ A and 30 $\mu$ A to -30 $\mu$ A and 5 $\mu$ A Changed the $I_X$ current values of ZZ on page # 18 from -30 $\mu$ A and 5 $\mu$ A to -5 $\mu$ A and 30 $\mu$ A Changed $V_{IH} \leq V_{DD}$ to $V_{IH} < V_{DD}$ on page # 18 Replaced Package Name column with Package Diagram in the Ordering Information table Updated Ordering Information Table
*D	475009	See ECN	VKN	Added the Maximum Rating for Supply Voltage on $V_{DDQ}$ Relative to GND Changed $t_{TH}$ , $t_{TL}$ from 25 ns to 20 ns and $t_{TDOV}$ from 5 ns to 10 ns in TAP AC Switching Characteristics table. Updated the Ordering Information table.
*E	776456	See ECN	VKN	Added Part numbers CY7C1380F and CY7C1382F and its related information Added footnote# 3 regarding Chip Enable Updated Ordering Information table
*F	2648065	01/27/09	VKN/PYRS	Modified note on top of the Ordering information table Updated Ordering Information table to include CY7C1380F/CY7C1382F in 100-Pin TSOP and 165 BGA package

## Sales, Solutions, and Legal Information

### Worldwide Sales and Design Support

Cypress maintains a worldwide network of offices, solution centers, manufacturer’s representatives, and distributors. To find the office closest to you, visit us at [cypress.com/sales](http://cypress.com/sales).

#### Products

PSoC	<a href="http://psoc.cypress.com">psoc.cypress.com</a>
Clocks & Buffers	<a href="http://clocks.cypress.com">clocks.cypress.com</a>
Wireless	<a href="http://wireless.cypress.com">wireless.cypress.com</a>
Memories	<a href="http://memory.cypress.com">memory.cypress.com</a>
Image Sensors	<a href="http://image.cypress.com">image.cypress.com</a>

#### PSoC Solutions

General	<a href="http://psoc.cypress.com/solutions">psoc.cypress.com/solutions</a>
Low Power/Low Voltage	<a href="http://psoc.cypress.com/low-power">psoc.cypress.com/low-power</a>
Precision Analog	<a href="http://psoc.cypress.com/precision-analog">psoc.cypress.com/precision-analog</a>
LCD Drive	<a href="http://psoc.cypress.com/lcd-drive">psoc.cypress.com/lcd-drive</a>
CAN 2.0b	<a href="http://psoc.cypress.com/can">psoc.cypress.com/can</a>
USB	<a href="http://psoc.cypress.com/usb">psoc.cypress.com/usb</a>

© Cypress Semiconductor Corporation, 2006-2009. The information contained herein is subject to change without notice. Cypress Semiconductor Corporation assumes no responsibility for the use of any circuitry other than circuitry embodied in a Cypress product. Nor does it convey or imply any license under patent or other rights. Cypress products are not warranted nor intended to be used for medical, life support, life saving, critical control or safety applications, unless pursuant to an express written agreement with Cypress. Furthermore, Cypress does not authorize its products for use as critical components in life-support systems where a malfunction or failure may reasonably be expected to result in significant injury to the user. The inclusion of Cypress products in life-support systems application implies that the manufacturer assumes all risk of such use and in doing so indemnifies Cypress against all charges.

Any Source Code (software and/or firmware) is owned by Cypress Semiconductor Corporation (Cypress) and is protected by and subject to worldwide patent protection (United States and foreign), United States copyright laws and international treaty provisions. Cypress hereby grants to licensee a personal, non-exclusive, non-transferable license to copy, use, modify, create derivative works of, and compile the Cypress Source Code and derivative works for the sole purpose of creating custom software and or firmware in support of licensee product to be used only in conjunction with a Cypress integrated circuit as specified in the applicable agreement. Any reproduction, modification, translation, compilation, or representation of this Source Code except as specified above is prohibited without the express written permission of Cypress.

Disclaimer: CYPRESS MAKES NO WARRANTY OF ANY KIND, EXPRESS OR IMPLIED, WITH REGARD TO THIS MATERIAL, INCLUDING, BUT NOT LIMITED TO, THE IMPLIED WARRANTIES OF MERCHANTABILITY AND FITNESS FOR A PARTICULAR PURPOSE. Cypress reserves the right to make changes without further notice to the materials described herein. Cypress does not assume any liability arising out of the application or use of any product or circuit described herein. Cypress does not authorize its products for use as critical components in life-support systems where a malfunction or failure may reasonably be expected to result in significant injury to the user. The inclusion of Cypress’ product in a life-support systems application implies that the manufacturer assumes all risk of such use and in doing so indemnifies Cypress against all charges.

Use may be limited by and subject to the applicable Cypress software license agreement.