

DIN-Signal C096FP-4,5C1-2



Image is for illustration purposes only. Please refer to product description.

Part number	09 03 296 6850
Specification	DIN-Signal C096FP-4,5C1-2
HARTING eCatalogue	https://b2b.harting.com/09032966850

Identification

Category	Connectors
Series	DIN 41612
Identification	Type C
Element	Female connector
Description of the contact	Straight
Features	lead-free

Version

Termination method	Press-in termination
Connection type	Motherboard to daughtercard Mezzanine
Number of contacts	96
Contact configuration	Rows a, b and c, positions 1, 2, ... , 31, 32
Termination length	4.5 mm
Coding	Coding with loss of contacts
PCB fixing	With fixing flange

Technical characteristics

Contact rows	3
Contact spacing (termination side)	2.54 mm
Contact spacing (mating side)	2.54 mm
Rated current	2 A
Rated current	Rated current measured at 20 °C, see derating curve for details



Pushing Performance
Since 1945

Technical characteristics

Clearance distance	≥1.2 mm
Creepage distance	≥1.2 mm
Insulation resistance	>10 ¹² Ω
Contact resistance	≤20 mΩ
Limiting temperature	-40 ... +105 °C upper limiting temperature limited by the pcb
Insertion and withdrawal force	≤90 N
Performance level	2 acc. to IEC 60603-2
Mating cycles	≥400
Test voltage U _{r.m.s.}	1 kV
Isolation group	IIIa (175 ≤ CTI < 400)
PCB thickness	≥1.6 mm
Hot plugging	No

Material properties

Material (insert)	Thermoplastic resin, glass-fibre filled
Colour (insert)	RAL 7032 (pebble grey)
Material (contacts)	Copper alloy
Surface (contacts)	Noble metal over Ni Mating side Ni Termination side
Material flammability class acc. to UL 94	V-0
RoHS	compliant
ELV status	compliant
China RoHS	e
REACH Annex XVII substances	Not contained
REACH ANNEX XIV substances	Not contained
REACH SVHC substances	Not contained
California Proposition 65 substances	Yes
California Proposition 65 substances	Antimony trioxide Nickel
Requirement set with Hazard Levels	R26

Specifications and approvals

Specifications	IEC 60603-2
----------------	-------------

Recommended configuration of plated through holes

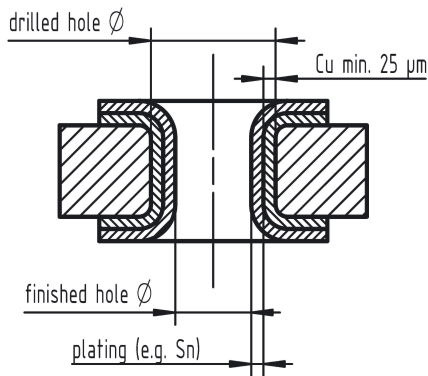

Tin plated PCB (HAL) acc. to EN 60352-5	Drilled hole \varnothing	$1,15 \pm 0,025 \text{ mm}$
	Sn	max. $15 \mu\text{m}$
	plated hole \varnothing	$0,94 - 1,09 \text{ mm}$
Chemical tin plated PCB	Drilled hole \varnothing	$1,15 \pm 0,025 \text{ mm}$
	Sn	min. $0,8 \mu\text{m}$
Gold /Nickel plated PCB	Drilled hole \varnothing	$1,15 \pm 0,025 \text{ mm}$
	Ni	$3 - 7 \mu\text{m}$
	Au	$0,05 - 0,12 \mu\text{m}$
Silver plated PCB	Drilled hole \varnothing	$1,15 \pm 0,025 \text{ mm}$
	Ag	$0,1 - 0,3 \mu\text{m}$
Copper plated PCB (OSP)	Drilled hole \varnothing	$1,15 \pm 0,025 \text{ mm}$
	plated hole \varnothing	$1,00 - 1,10 \text{ mm}$

In addition to the hot-air-level (HAL) other pcb surfaces are getting more important. Due to their different properties, such as mechanical strength and coefficient of friction we recommend the above mentioned configuration of pcb through holes.

Assembly instructions

It is highly recommended to use HARTING press-in tools to ensure a reliable press-in process. Please refer to the catalogue for tools, machines and further information for the press-in process.

Mating conditions



To ensure reliable connections and prevent unnecessary damage, please refer to the application data diagrams. These recommendations are set out in IEC 60603-2. The connectors should not be coupled and decoupled under electrical load.