

FDZ203N

N-Channel 2.5V Specified PowerTrench® BGA MOSFET

General Description

Combining Fairchild's advanced 2.5V specified PowerTrench process with state of the art BGA packaging, the FDZ203N minimizes both PCB space and $R_{DS(ON)}$. This BGA MOSFET embodies a breakthrough in packaging technology which enables the device to combine excellent thermal transfer characteristics, high current handling capability, ultra-low profile packaging, low gate charge, and low $R_{DS(ON)}$.

Applications

- Battery management
- Load switch
- Battery protection



Features

- 7.5 A, 20 V. $R_{DS(ON)} = 18\text{ m}\Omega @ V_{GS} = 4.5$
 $R_{DS(ON)} = 30\text{ m}\Omega @ V_{GS} = 2.5\text{ V}$
- Occupies only 4 mm² of PCB area. Less than 40% of the area of a SSOT-6
- Ultra-thin package: less than 0.80 mm height when mounted to PCB
- Ultra-low $Q_g \times R_{DS(ON)}$ figure-of-merit.
- High power and current handling capability.
- RoHS Compliant

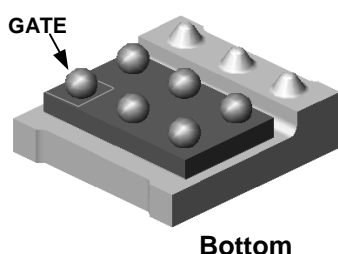

Bottom

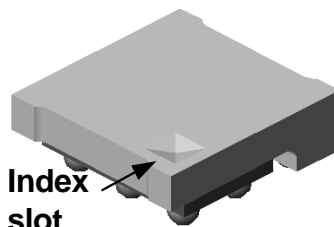

Index slot

Top

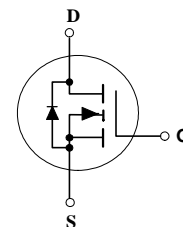

Absolute Maximum Ratings T_A=25°C unless otherwise noted

Symbol	Parameter	Rated	Units
V _{DSS}	Drain-Source Voltage	20	V
V _{GSS}	Gate-Source Voltage	±12	V
I _D	Drain Current – Continuous (Note 1a)	7.5	A
		20	
P _D	Power Dissipation (Steady State) (Note 1a)	1.6	W
T _J , T _{STG}	Operating and Storage Junction Temperature Range	-55 to +150	°C

Thermal Characteristics

R _{θJA}	Thermal Resistance, Junction-to-Ambient (Note 1a)	67	°C/W
R _{θJB}	Thermal Resistance, Junction-to-Ball (Note 1)	11	
R _{θJC}	Thermal Resistance, Junction-to-Case (Note 1)	1	

Package Marking and Ordering Information

Device Marking	Device	Reel Size	Tape width	Quantity
203N	FDZ203N	7"	8mm	3000 units

Electrical Characteristics

$T_A = 25^\circ\text{C}$ unless otherwise noted

Symbol	Parameter	Test Conditions	Min	Typ	Max	Units
--------	-----------	-----------------	-----	-----	-----	-------

Off Characteristics

BV_{DSS}	Drain-Source Breakdown Voltage	$V_{GS} = 0\text{ V}, I_D = 250\ \mu\text{A}$	20			V
$\frac{\Delta BV_{DSS}}{\Delta T_J}$	Breakdown Voltage Temperature Coefficient	$I_D = 250\ \mu\text{A}$, Referenced to 25°C		14		mV/ $^\circ\text{C}$
I_{DSS}	Zero Gate Voltage Drain Current	$V_{DS} = 16\text{ V}, V_{GS} = 0\text{ V}$			1	μA
I_{GSSF}	Gate-Body Leakage, Forward	$V_{GS} = 12\text{ V}, V_{DS} = 0\text{ V}$			100	nA
I_{GSSR}	Gate-Body Leakage, Reverse	$V_{GS} = -12\text{ V}, V_{DS} = 0\text{ V}$			-100	nA

On Characteristics (Note 2)

$V_{GS(th)}$	Gate Threshold Voltage	$V_{DS} = V_{GS}, I_D = 250\ \mu\text{A}$	0.6	0.8	1.5	V
$\frac{\Delta V_{GS(th)}}{\Delta T_J}$	Gate Threshold Voltage Temperature Coefficient	$I_D = 250\ \mu\text{A}$, Referenced to 25°C		-3		mV/ $^\circ\text{C}$
$R_{DS(on)}$	Static Drain-Source On-Resistance	$V_{GS} = 4.5\text{ V}, I_D = 7.5\text{ A}$ $V_{GS} = 2.5\text{ V}, I_D = 5.5\text{ A}$ $V_{GS} = 4.5\text{ V}, I_D = 7.5\text{ A}, T_J = 125^\circ\text{C}$		14 20	18 30	m Ω
$I_{D(on)}$	On-State Drain Current	$V_{GS} = 4.5\text{ V}, V_{DS} = 5\text{ V}$	20			A
g_{FS}	Forward Transconductance	$V_{DS} = 10\text{ V}, I_D = 7.5\text{ A}$		33		S

Dynamic Characteristics

C_{iss}	Input Capacitance	$V_{DS} = 10\text{ V}, V_{GS} = 0\text{ V}$		1127		pF
C_{oss}	Output Capacitance	$f = 1.0\text{ MHz}$		268		pF
C_{riss}	Reverse Transfer Capacitance			134		pF

Switching Characteristics (Note 2)

$t_{d(on)}$	Turn-On Delay Time	$V_{DD} = 10\text{ V}, I_D = 1\text{ A}$		8	16	ns
t_r	Turn-On Rise Time	$V_{GS} = 4.5\text{ V}, R_{GEN} = 6\ \Omega$		11	20	ns
$t_{d(off)}$	Turn-Off Delay Time			26	42	ns
t_f	Turn-Off Fall Time			8	16	ns
Q_g	Total Gate Charge	$V_{DS} = 10\text{ V}, I_D = 7.5\text{ A}$		11	15	nC
Q_{gs}	Gate-Source Charge	$V_{GS} = 4.5\text{ V}$		2		nC
Q_{gd}	Gate-Drain Charge			3		nC

Drain-Source Diode Characteristics and Maximum Ratings

I_S	Maximum Continuous Drain-Source Diode Forward Current				1.3	A
V_{SD}	Drain-Source Diode Forward Voltage	$V_{GS} = 0\text{ V}, I_S = 1.3\text{ A}$ (Note 2)		0.7	1.2	V
t_{rr}	Diode Reverse Recovery Time	$I_F = 9\text{ A}$		20		nS
Q_{rr}	Diode Reverse Recovery Charge	$dI_F/dt = 100\text{ A}/\mu\text{s}$		14		nC

Notes:

- $R_{\theta JA}$ is determined with the device mounted on a 1 in² 2 oz. copper pad on a 1.5 x 1.5 in. board of FR-4 material. The thermal resistance from the junction to the circuit board side of the solder ball, $R_{\theta JB}$, is defined for reference. For $R_{\theta JC}$, the thermal reference point for the case is defined as the top surface of the copper chip carrier. $R_{\theta JC}$ and $R_{\theta JB}$ are guaranteed by design while $R_{\theta JA}$ is determined by the user's board design.

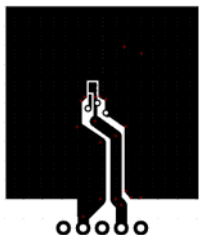

- a) 67 $^\circ\text{C}/\text{W}$ when mounted on a 1 in² pad of 2 oz copper, 1.5" x 1.5" x 0.062" thick PCB



- b) 155 $^\circ\text{C}/\text{W}$ when mounted on a minimum pad of 2 oz copper

Scale 1 : 1 on letter size paper

- Pulse Test: Pulse Width < 300 μs , Duty Cycle < 2.0%

Dimensional Outline and Pad Layout

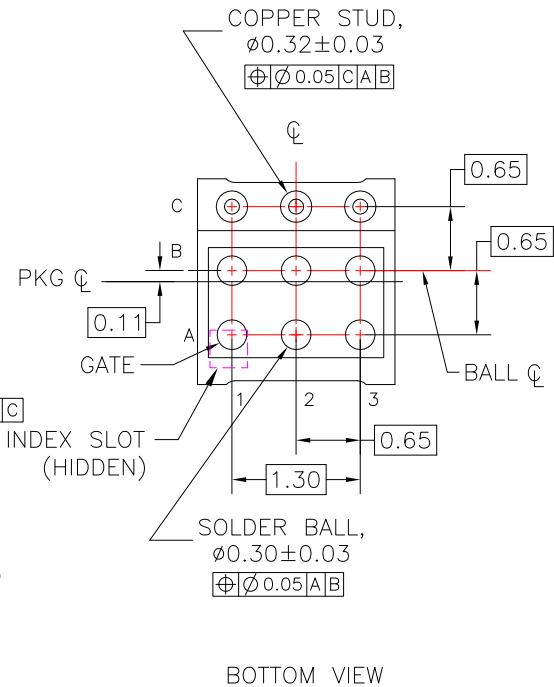
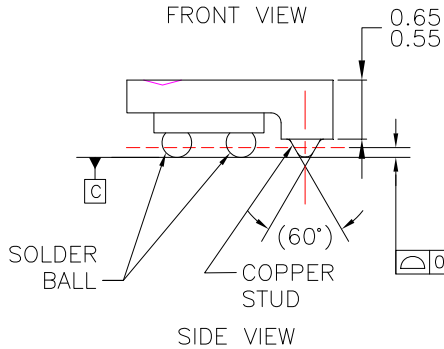
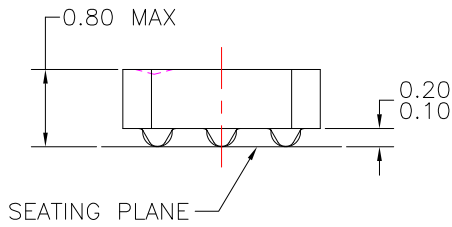
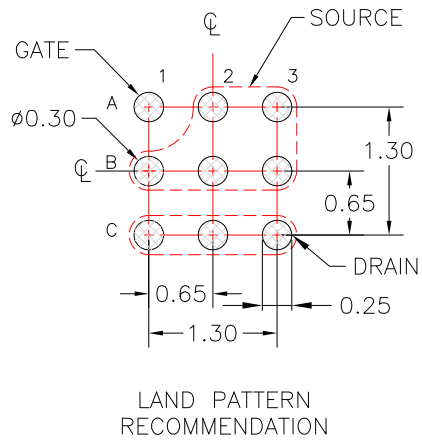
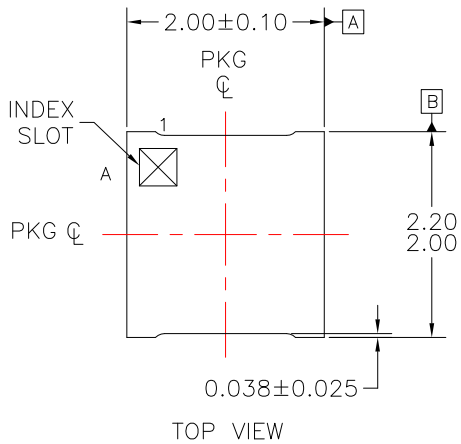

NOTES: UNLESS OTHERWISE SPECIFIED

- A) THIS PKG IS NOT PRESENTLY REGISTERED WITH ANY STANDARDS COMMITTEE.
- B) ALL DIMENSIONS ARE IN MILLIMETERS.
- C) DRAWING CONFORMS TO ASME Y14.5M-1994.
- D) LAND PATTERN NAME: BGA9C65P3X3_200X200X80
- E) TERMINAL CONFIGURATION TABLE.

POSITION	DESIGNATION	TYPE
C1,C2,C3	DRAIN	COPPER STUD
A1	GATE	SOLDER BALL
A2,A3,B1,B2,B3	SOURCE	SOLDER BALL

F) DRAWING FILENAME: MKT-BGA06Brev6

Typical Characteristics

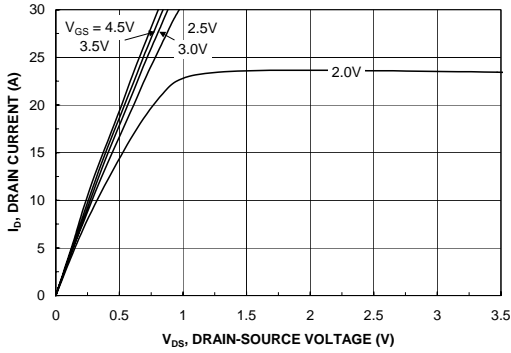

Figure 1. On-Region Characteristics.

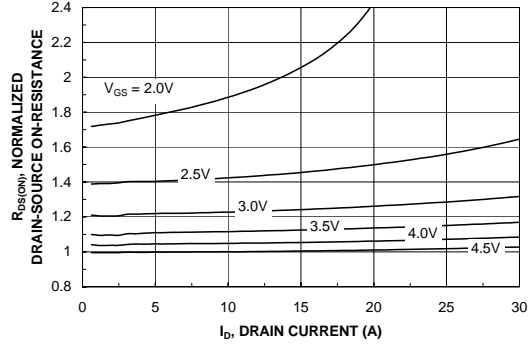

Figure 2. On-Resistance Variation with Drain Current and Gate Voltage.

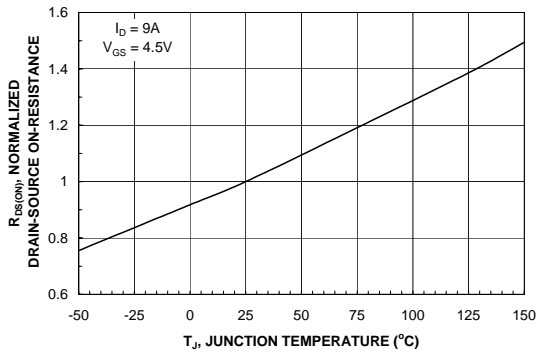

Figure 3. On-Resistance Variation with Temperature.

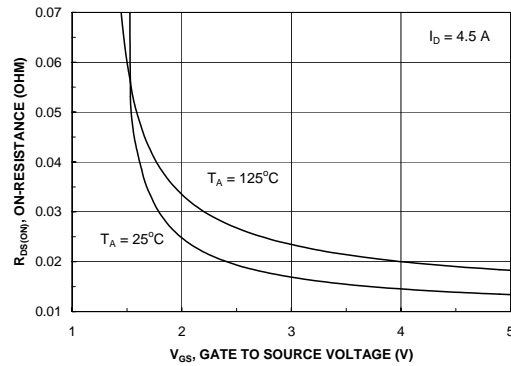

Figure 4. On-Resistance Variation with Gate-to-Source Voltage.

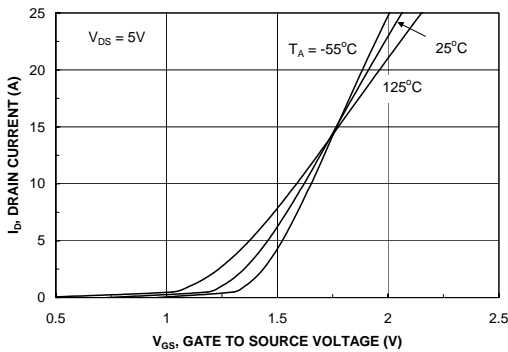

Figure 5. Transfer Characteristics.

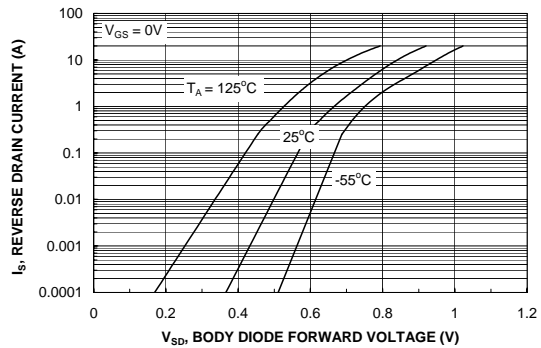

Figure 6. Body Diode Forward Voltage Variation with Source Current and Temperature.

Typical Characteristics

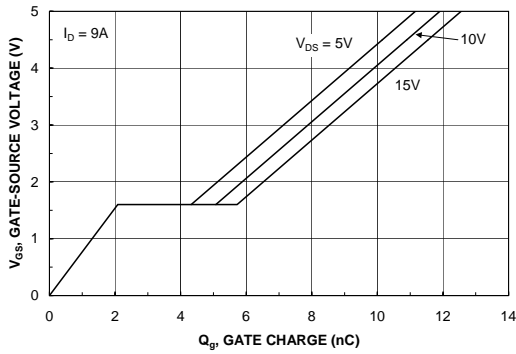

Figure 7. Gate Charge Characteristics.

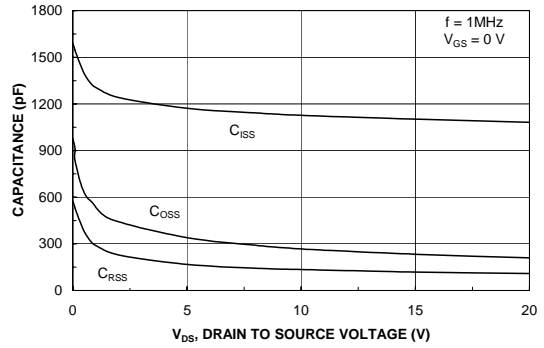

Figure 8. Capacitance Characteristics.

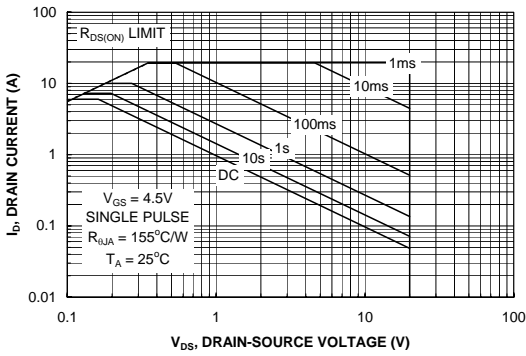

Figure 9. Maximum Safe Operating Area.

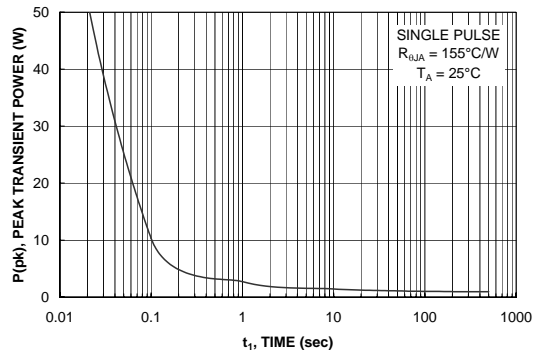

Figure 10. Single Pulse Maximum Power Dissipation.

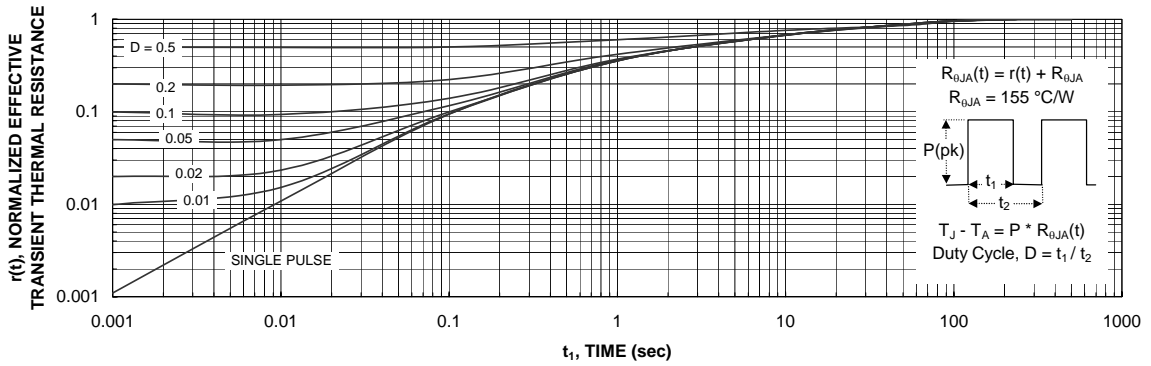



Figure 11. Transient Thermal Response Curve.

Thermal characterization performed using the conditions described in Note 1b. Transient thermal response will change depending on the circuit board design.



TRADEMARKS

The following includes registered and unregistered trademarks and service marks, owned by Fairchild Semiconductor and/or its global subsidiaries, and is not intended to be an exhaustive list of all such trademarks.

- | | | | |
|---|---|---|---|
| ACE ^x ® | FPS™ | PDP-SPM™ | The Power Franchise® |
| Build it Now™ | F-PFS™ | Power-SPM™ | power
the franchise |
| CorePLUS™ | FRFET® | PowerTrench® | TinyBoost™ |
| CorePOWER™ | Global Power Resource SM | Programmable Active Droop™ | TinyBuck™ |
| CROSSVOLT™ | Green FPS™ | QFET® | TinyLogic® |
| CTL™ | Green FPS™ e-Series™ | QS™ | TINYOPTO™ |
| Current Transfer Logic™ | GTO™ | Quiet Series™ | TinyPower™ |
| EcoSPARK® | IntelliMAX™ | RapidConfigure™ | TinyPWM™ |
| EfficientMax™ | ISOPLANAR™ | Saving our world 1mW at a time™ | TinyWire™ |
| EZSWITCH™ * | MegaBuck™ | SmartMax™ | µSerDes™ |
|  | MICROCOUPLER™ | SMART START™ |  |
|  | MicroFET™ | SPM® | UHC® |
| Fairchild® | MicroPak™ | STEALTH™ | Ultra FRFET™ |
| Fairchild Semiconductor® | MillerDrive™ | SuperFET™ | UniFET™ |
| FACT Quiet Series™ | MotionMax™ | SuperSOT™-3 | VCX™ |
| FACT® | Motion-SPM™ | SuperSOT™-6 | VisualMax™ |
| FAST® | OPTOLOGIC® | SuperSOT™-8 | |
| FastvCore™ | OPTOPLANAR® | SuperMOS™ | |
| FlashWriter® * |  |  | |

* EZSWITCH™ and FlashWriter® are trademarks of System General Corporation, used under license by Fairchild Semiconductor.

DISCLAIMER

FAIRCHILD SEMICONDUCTOR RESERVES THE RIGHT TO MAKE CHANGES WITHOUT FURTHER NOTICE TO ANY PRODUCTS HEREIN TO IMPROVE RELIABILITY, FUNCTION, OR DESIGN. FAIRCHILD DOES NOT ASSUME ANY LIABILITY ARISING OUT OF THE APPLICATION OR USE OF ANY PRODUCT OR CIRCUIT DESCRIBED HEREIN; NEITHER DOES IT CONVEY ANY LICENSE UNDER ITS PATENT RIGHTS, NOR THE RIGHTS OF OTHERS. THESE SPECIFICATIONS DO NOT EXPAND THE TERMS OF FAIRCHILD'S WORLDWIDE TERMS AND CONDITIONS, SPECIFICALLY THE WARRANTY THEREIN, WHICH COVERS THESE PRODUCTS.

LIFE SUPPORT POLICY

FAIRCHILD'S PRODUCTS ARE NOT AUTHORIZED FOR USE AS CRITICAL COMPONENTS IN LIFE SUPPORT DEVICES OR SYSTEMS WITHOUT THE EXPRESS WRITTEN APPROVAL OF FAIRCHILD SEMICONDUCTOR CORPORATION.

As used herein:

- Life support devices or systems are devices or systems which, (a) are intended for surgical implant into the body or (b) support or sustain life, and (c) whose failure to perform when properly used in accordance with instructions for use provided in the labeling, can be reasonably expected to result in a significant injury of the user.
- A critical component in any component of a life support, device, or system whose failure to perform can be reasonably expected to cause the failure of the life support device or system, or to affect its safety or effectiveness.

PRODUCT STATUS DEFINITIONS

Definition of Terms

Datasheet Identification	Product Status	Definition
Advance Information	Formative or In Design	This datasheet contains the design specifications for product development. Specifications may change in any manner without notice.
Preliminary	First Production	This datasheet contains preliminary data; supplementary data will be published at a later date. Fairchild Semiconductor reserves the right to make changes at any time without notice to improve design.
No Identification Needed	Full Production	This datasheet contains final specifications. Fairchild Semiconductor reserves the right to make changes at any time without notice to improve the design.
Obsolete	Not In Production	This datasheet contains specifications on a product that is discontinued by Fairchild Semiconductor. The datasheet is for reference information only.