



50MHz to 1000MHz, 75dB Logarithmic Detector/Controller

MAX2014

General Description

Features

The MAX2014 complete multistage logarithmic amplifier is designed to accurately convert radio-frequency (RF) signal power in the 50MHz to 1000MHz frequency range to an equivalent DC voltage. The outstanding dynamic range and precision over temperature of this log amplifier make it particularly useful for a variety of base-station and other wireless applications, including automatic gain control (AGC), transmitter power measurements, and received-signal-strength indication (RSSI) for terminal devices.

The MAX2014 can also be operated in a controller mode where it measures, compares, and controls the output power of a variable-gain amplifier as part of a fully integrated AGC loop.

This logarithmic amplifier provides much wider measurement range and superior accuracy compared to controllers based on diode detectors, while achieving excellent temperature stability over the full -40°C to +85°C operating range.

- ◆ Complete RF Detector/Controller
- ◆ 50MHz to 1000MHz Frequency Range
- ◆ Exceptional Accuracy Over Temperature
- ◆ High Dynamic Range
- ◆ 2.7V to 5.25V Supply Voltage Range*
- ◆ Scaling Stable Over Supply and Temperature Variations
- ◆ Controller Mode with Error Output
- ◆ Shutdown Mode with Typically 1µA of Supply Current
- ◆ Available in 8-Pin TDFN and 8-pin µMAX® Package

Applications

- AGC Measurement and Control
- RF Transmitter Power Measurement
- RSSI Measurements
- Cellular Base-Station, WLAN, Microwave Link, Radar, and other Military Applications
- Optical Networks

*See the Power-Supply Connections section.

Ordering Information appears at end of data sheet.

µMAX is a registered trademark of Maxim Integrated Products, Inc.

Functional Diagram

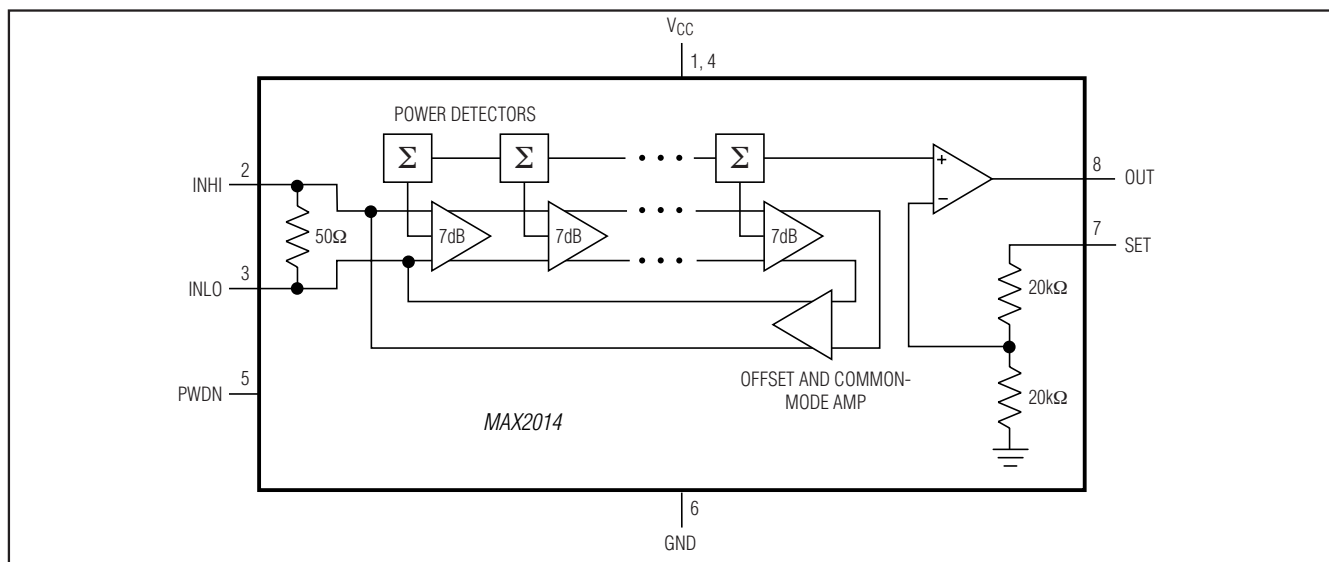

Pin Configuration appears at end of data sheet.



For pricing, delivery, and ordering information, please contact Maxim Direct at 1-888-629-4642, or visit Maxim's website at www.maxim-ic.com.

50MHz to 1000MHz, 75dB Logarithmic Detector/Controller

ABSOLUTE MAXIMUM RATINGS

V _{CC} (Pins 1, 4) to GND	-0.3V to +5.25V
SET, PWDN to GND	-0.3V to (V _{CC} + 0.3V)
Input Power Differential (INHI, INLO)	+23dBm
Input Power Single Ended (INHI or INLO grounded)	+19dBm
Continuous Power Dissipation (T _A = +70°C)	
TDFN (derate 18.5mW/°C above +70°C)	1480mW
μMAX (derate 4.5mW/°C above +70°C)	362mW

Operating Temperature Range	-40°C to +85°C
Junction Temperature	+150°C
Storage Temperature Range	-65°C to +150°C
Lead Temperature (soldering, 10s)	+300°C
Soldering Temperature (reflow)	+260°C

Stresses beyond those listed under "Absolute Maximum Ratings" may cause permanent damage to the device. These are stress ratings only, and functional operation of the device at these or any other conditions beyond those indicated in the operational sections of the specifications is not implied. Exposure to absolute maximum rating conditions for extended periods may affect device reliability.

PACKAGE THERMAL CHARACTERISTICS (Note 1)

TDFN:

Junction-to-Ambient Thermal Resistance (θ _{JA})	54°C/W
Junction-to-Case Thermal Resistance (θ _{JC})	8°C/W

μMAX:

Junction-to-Ambient Thermal Resistance (θ _{JA})	221°C/W
Junction-to-Case Thermal Resistance (θ _{JC})	42°C/W

Note 1: Package thermal resistances were obtained using the method described in JEDEC specification JESD51-7. For detailed information on package thermal considerations, refer to www.maxim-ic.com/thermal-tutorial.

DC ELECTRICAL CHARACTERISTICS

(Typical Application Circuit (Figure 1), V_S = +3.3V, f_{RF} = 50MHz to 1000MHz, R₁ = 0Ω, R₄ = 0Ω, R_L = 10kΩ, T_A = -40°C to +85°C, unless otherwise noted. Typical values are at T_A = +25°C, unless otherwise noted.) (Note 2)

PARAMETER	SYMBOL	CONDITIONS	MIN	TYP	MAX	UNITS
POWER SUPPLY						
Supply Voltage	V _S	R ₄ = 75Ω ±1%, PWDN must be connected to GND	4.75		5.25	V
		R ₄ = 0Ω	2.7		3.6	
Supply Current	I _{CC}	T _A = +25°C, V _S = 5.25V, R ₄ = 75Ω		17.3		mA
		T _A = +25°C		17.3	20.5	
Supply Current Variation with Temp	I _{CC}	T _A = -40°C to +85°C		0.05		mA/°C
Shutdown Current	I _{CC}	V _{PWDN} = V _{CC}		1		μA
CONTROLLER REFERENCE (SET)						
SET Input Voltage Range				0.5 to 1.8		V
SET Input Impedance				40		kΩ
DETECTOR OUTPUT (OUT)						
Source Current				4		mA
Sink Current				450		μA
Minimum Output Voltage	V _{OUT(MIN)}			0.5		V
Maximum Output Voltage	V _{OUT(MAX)}			1.8		V

50MHz to 1000MHz, 75dB Logarithmic Detector/Controller

MAX2014

AC ELECTRICAL CHARACTERISTICS

(Typical Application Circuit (Figure 1), $V_S = +3.3V$, $f_{RF} = 50MHz$ to $1000MHz$, $R_1 = 0\Omega$, $R_4 = 0\Omega$, $R_L = 10k\Omega$, $T_A = -40^\circ C$ to $+85^\circ C$, unless otherwise noted. Typical values are at $T_A = +25^\circ C$, unless otherwise noted.) (Note 2)

PARAMETER	SYMBOL	CONDITIONS	MIN	TYP	MAX	UNITS
RF Input Frequency Range	f_{RF}			50 to 1000		MHz
Return Loss	S_{11}			-15		dB
Large-Signal Response Time		$P_{IN} =$ no signal to $0dBm$, $\pm 0.5dB$ settling accuracy		150		ns
RSSI MODE—50MHz						
RF Input Power Range		(Note 3)		-65 to +5		dBm
$\pm 3dB$ Dynamic Range		$T_A = -40^\circ C$ to $+85^\circ C$ (Note 4)		70		dB
Range Center				-30		dBm
Temp Sensitivity when $T_A > +25^\circ C$		$T_A = +25^\circ C$ to $+85^\circ C$, $P_{IN} = -25dBm$		+0.0083		dB/ $^\circ C$
Temp Sensitivity when $T_A < +25^\circ C$		$T_A = -40^\circ C$ to $+25^\circ C$, $P_{IN} = -25dBm$		-0.0154		dB/ $^\circ C$
Slope		(Note 5)		19		mV/dB
Typical Slope Variation		$T_A = -40^\circ C$ to $+85^\circ C$		-4		$\mu V/^\circ C$
Intercept		(Note 6)		-100		dBm
Typical Intercept Variation		$T_A = -40^\circ C$ to $+85^\circ C$		0.03		dBm/ $^\circ C$
RSSI MODE—100MHz						
RF Input Power Range		(Note 3)		-65 to +5		dBm
$\pm 3dB$ Dynamic Range		$T_A = -40^\circ C$ to $+85^\circ C$ (Note 4)		70		dB
Range Center				-30		dBm
Temp Sensitivity when $T_A > +25^\circ C$		$T_A = +25^\circ C$ to $+85^\circ C$, $P_{IN} = -25dBm$		+0.0083		dB/ $^\circ C$
Temp Sensitivity when $T_A < +25^\circ C$		$T_A = -40^\circ C$ to $+25^\circ C$, $P_{IN} = -25dBm$		-0.0154		dB/ $^\circ C$
Slope		(Note 5)		19		mV/dB
Typical Slope Variation		$T_A = -40^\circ C$ to $+85^\circ C$		-4		$\mu V/^\circ C$
Intercept		(Note 6)		-100		dBm
Typical Intercept Variation		$T_A = -40^\circ C$ to $+85^\circ C$		0.03		dBm/ $^\circ C$
RSSI MODE—900MHz						
RF Input Power Range		(Note 3)		-65 to +5		dBm
$\pm 3dB$ Dynamic Range		$T_A = -40^\circ C$ to $+85^\circ C$ (Note 4)		70		dB
Range Center				-30		dBm
Temp Sensitivity when $T_A > +25^\circ C$		$T_A = +25^\circ C$ to $+85^\circ C$, $P_{IN} = -25dBm$		± 0.0083		dB/ $^\circ C$

50MHz to 1000MHz, 75dB Logarithmic Detector/Controller

AC ELECTRICAL CHARACTERISTICS (continued)

(Typical Application Circuit (Figure 1), $V_S = +3.3V$, $f_{RF} = 50MHz$ to $1000MHz$, $R_1 = 0\Omega$, $R_4 = 0\Omega$, $R_L = 10k\Omega$, $T_A = -40^\circ C$ to $+85^\circ C$, unless otherwise noted. Typical values are at $T_A = +25^\circ C$, unless otherwise noted.) (Note 2)

PARAMETER	SYMBOL	CONDITIONS	MIN	TYP	MAX	UNITS
Temp Sensitivity when $T_A < +25^\circ C$		$T_A = -40^\circ C$ to $+25^\circ C$, $P_{IN} = -25dBm$		-0.0154		dB/ $^\circ C$
Slope		(Note 5)		18.1		mV/dB
Typical Slope Variation		$T_A = -40^\circ C$ to $+85^\circ C$		-4		$\mu V/^\circ C$
Intercept		(Note 6)		-97		dBm
Typical Intercept Variation		$T_A = -40^\circ C$ to $+85^\circ C$		0.02		dBm/ $^\circ C$

Note 2: The MAX2014 is guaranteed by design for $T_A = -40^\circ C$ to $+85^\circ C$, as specified.

Note 3: Typical minimum and maximum range of the detector at the stated frequency.

Note 4: Dynamic range refers to the range over which the error remains within the stated bounds. The error is calculated at $T_A = -40^\circ C$ and $+85^\circ C$, relative to the curve at $T_A = +25^\circ C$.

Note 5: The slope is the variation of the output voltage per change in input power. It is calculated by fitting a root-mean-square (RMS) straight line to the data indicated by RF input power range.

Note 6: The intercept is an extrapolated value that corresponds to the output voltage for which the output voltage is zero. It is calculated by fitting an RMS straight line to the data.

Typical Operating Characteristics

(Typical Application Circuit (Figure 1), $V_S = V_{CC} = 3.3V$, $P_{IN} = -10dBm$, $f_{IN} = 100MHz$, $R_1 = 0\Omega$, $R_4 = 0\Omega$, $R_L = 10k\Omega$, $V_{PWRN} = 0V$, $T_A = +25^\circ C$, unless otherwise noted.)

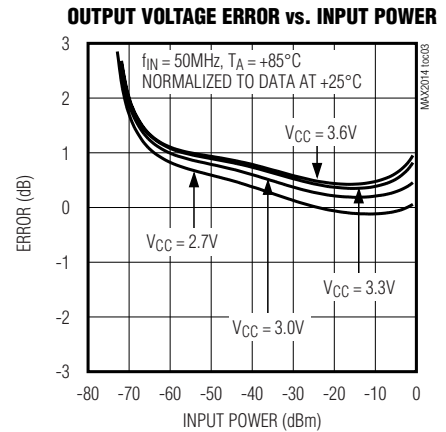
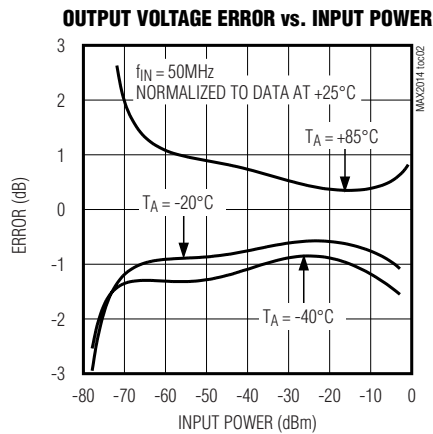
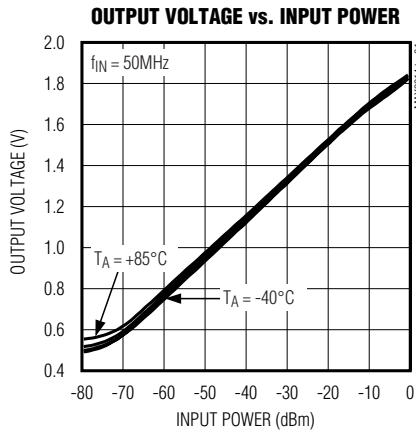

50MHz to 1000MHz, 75dB Logarithmic Detector/Controller

MAX2014

Typical Operating Characteristics (continued)

(Typical Application Circuit (Figure 1), $V_S = V_{CC} = 3.3V$, $P_{IN} = -10dBm$, $f_{IN} = 100MHz$, $R_1 = 0\Omega$, $R_4 = 0\Omega$, $R_L = 10k\Omega$, $V_{PWDN} = 0V$, $T_A = +25^\circ C$, unless otherwise noted.)

OUTPUT VOLTAGE ERROR vs. INPUT POWER

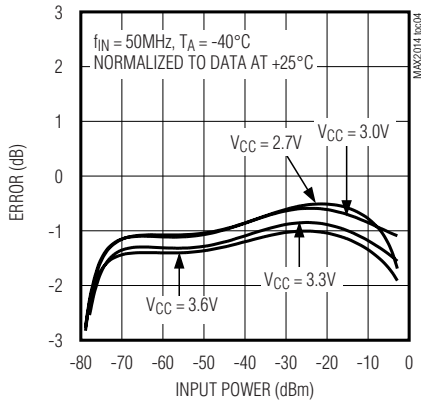

OUTPUT VOLTAGE vs. INPUT POWER

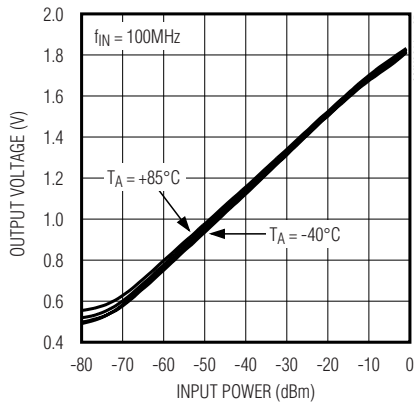

OUTPUT VOLTAGE ERROR vs. INPUT POWER

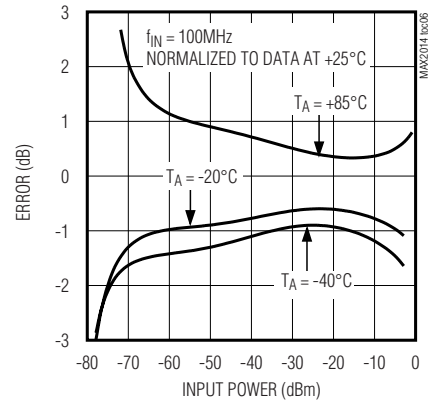

OUTPUT VOLTAGE ERROR vs. INPUT POWER

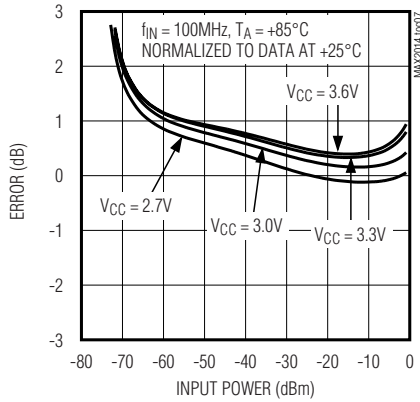

OUTPUT VOLTAGE ERROR vs. INPUT POWER

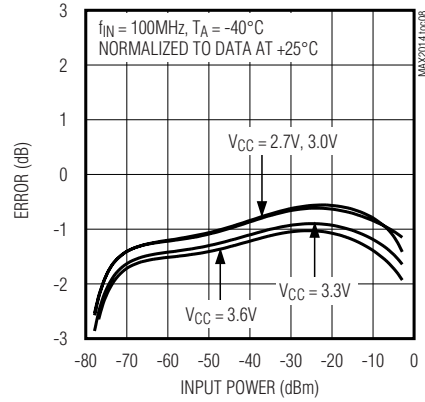

50MHz to 1000MHz, 75dB Logarithmic Detector/Controller

Typical Operating Characteristics (continued)

(Typical Application Circuit (Figure 1), $V_S = V_{CC} = 3.3V$, $P_{IN} = -10dBm$, $f_{IN} = 100MHz$, $R_1 = 0\Omega$, $R_4 = 0\Omega$, $R_L = 10k\Omega$, $V_{P_WDN} = 0V$, $T_A = +25^\circ C$, unless otherwise noted.)

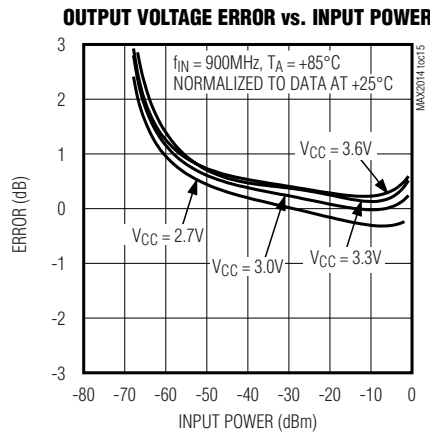
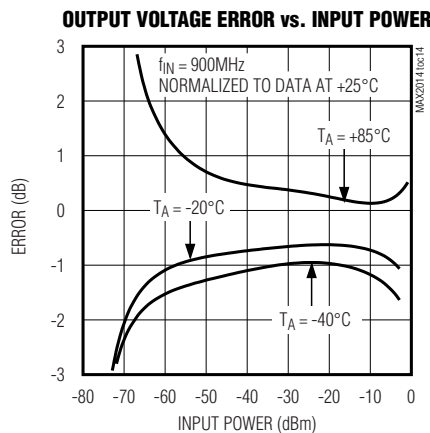
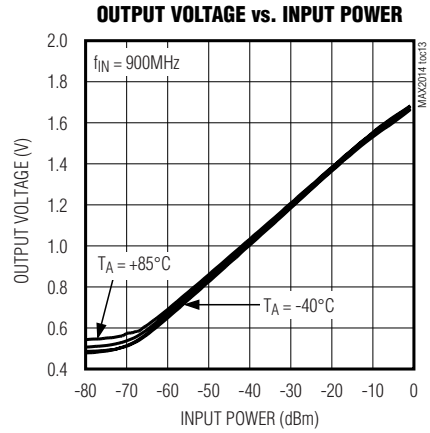
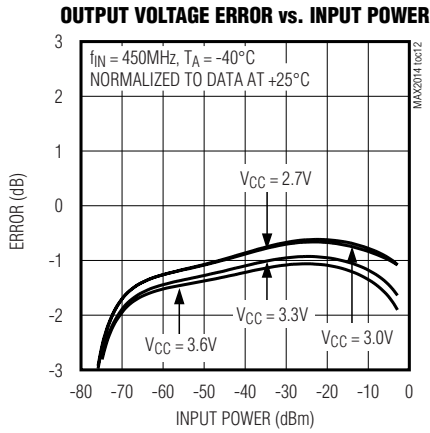
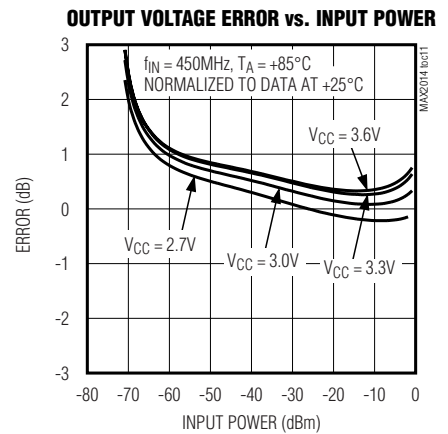
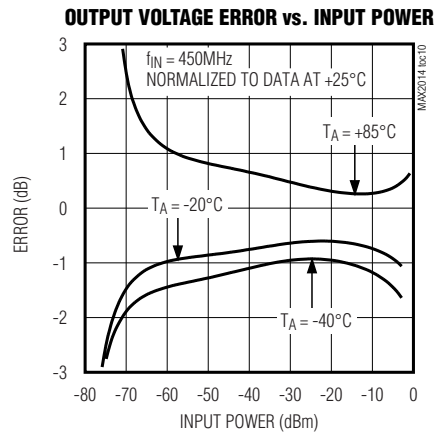
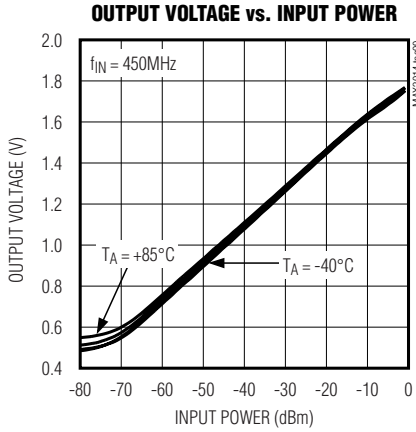

50MHz to 1000MHz, 75dB Logarithmic Detector/Controller

MAX2014

Typical Operating Characteristics (continued)

(Typical Application Circuit (Figure 1), $V_S = V_{CC} = 3.3V$, $P_{IN} = -10dBm$, $f_{IN} = 100MHz$, $R_1 = 0\Omega$, $R_4 = 0\Omega$, $R_L = 10k\Omega$, $V_{PWRN} = 0V$, $T_A = +25^\circ C$, unless otherwise noted.)

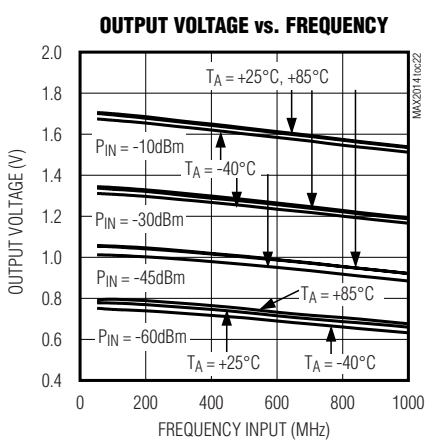
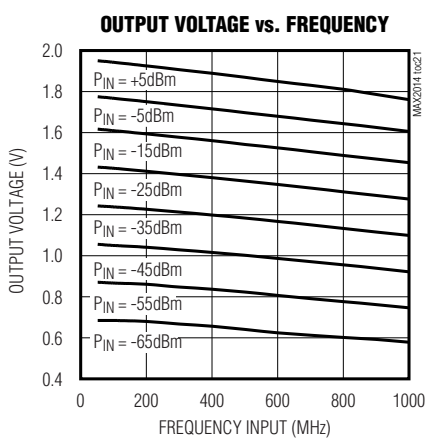
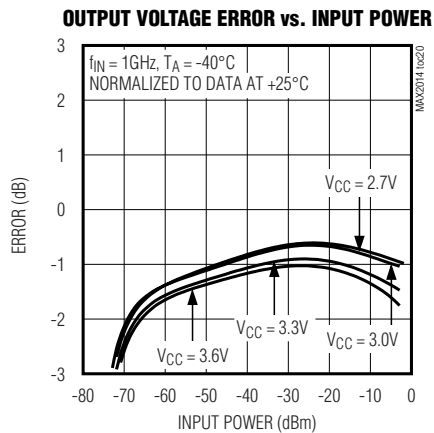
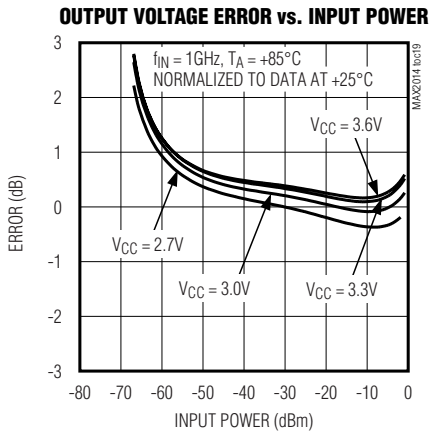
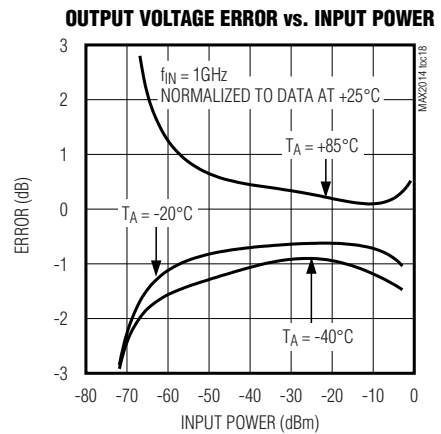
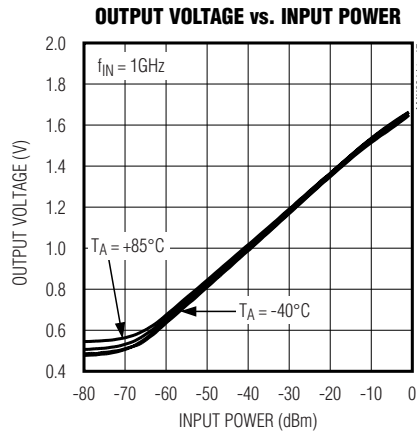
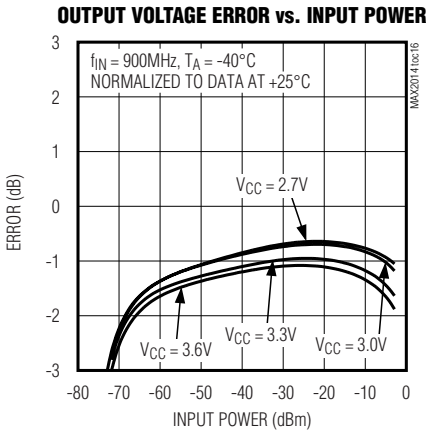

50MHz to 1000MHz, 75dB Logarithmic Detector/Controller

Typical Operating Characteristics (continued)

(Typical Application Circuit (Figure 1), $V_S = V_{CC} = 3.3V$, $P_{IN} = -10dBm$, $f_{IN} = 100MHz$, $R_1 = 0\Omega$, $R_4 = 0\Omega$, $R_L = 10k\Omega$, $V_{PWDN} = 0V$, $T_A = +25^\circ C$, unless otherwise noted.)

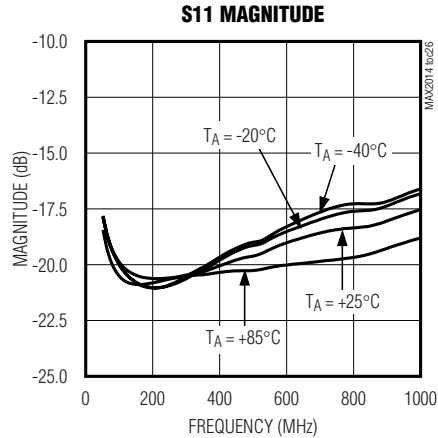
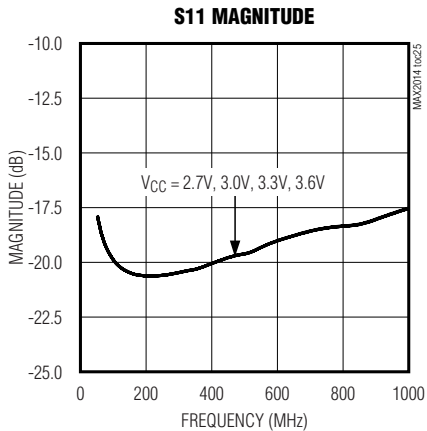
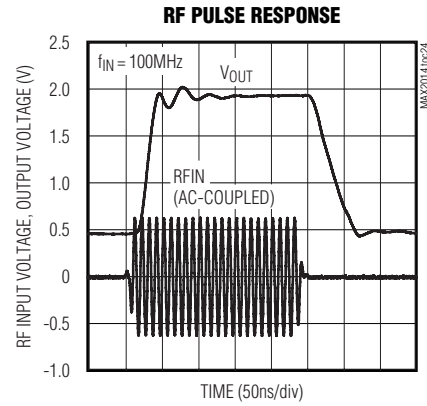
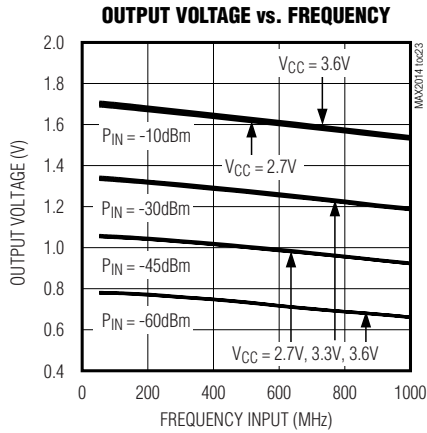

Pin Description

PIN	NAME	DESCRIPTION
1, 4	V_{CC}	Supply Voltage. Bypass with capacitors as specified in the typical application circuits. Place capacitors as close to the pin as possible (see the <i>Power-Supply Connections</i> section).
2, 3	INH1, INLO	Differential RF Inputs
5	PWDN	Power-Down Input. Drive PWDN with a logic-high to power down the IC. PWDN must be connected to GND for V_S between 4.75V and 5.25V with $R_4 = 75\Omega$.
6	GND	Ground. Connect to the printed circuit (PC) board ground plane.
7	SET	Set-Point Input. To operate in detector mode, connect SET to OUT. To operate in controller mode, connect a precision voltage source to control the power level of a power amplifier.
8	OUT	Detector Output. In detector mode, this output provides a voltage proportional to the log of the input power. In controller mode, this output is connected to a power-control input on a power amplifier (PA).
—	EP	Exposed Pad (TDFN Package Only). Connect EP to GND using multiple vias, or the EP can also be left unconnected.

50MHz to 1000MHz, 75dB Logarithmic Detector/Controller

Detailed Description

The MAX2014 is a successive detection logarithmic amplifier designed for use in RF power measurement and AGC applications with a 50MHz to 1000MHz frequency range from a single 2.7V to 3.6V power supply. It is pin compatible with other leading logarithmic amplifiers.

The MAX2014 provides for improved performance with a high 75dB dynamic range at 100MHz, and exceptional accuracy over the extended temperature range and supply voltage range.

RF Input

The MAX2014 differential RF input (INHI, INLO) allows for broadband signals between 50MHz and 1000MHz. For single-ended signals, AC-couple INLO to ground. The RF inputs are internally biased and need to be AC-coupled using 680pF capacitors as shown in Figures 1 and 2. An internal 50Ω resistor between INHI and INLO provides a good 50MHz to 1000MHz match.

SET Input

The SET input is used for loop control when in controller mode or to set the slope of the output signal (mV/dB) when in detector mode. The internal input structure of SET is two series 20kΩ resistors connected to ground. The center node of the resistors is fed to the negative input of the internal output op amp.

Power-Supply Connections

The MAX2014 requires power-supply bypass capacitors connected close to each VCC pin. At each VCC pin, connect a 0.1μF capacitor (C4, C6) and a 100pF capacitor (C3, C5), with the 100pF capacitor being closest to the pin.

For power-supply voltages (V_S) between 2.7V and 3.6V, set R4 = 0Ω (see the typical application circuits, Figures 1 and 2).

For power-supply voltages (V_S) between 4.75V and 5.25V, set R4 = 75Ω ±1% (100ppm/°C max) and PWDN must be connected to GND.

Power-Down Mode

The MAX2014 can be powered down by driving PWDN with logic-high (logic-high = V_{CC}). In power-down mode, the supply current is reduced to a typical value of 1μA. For normal operation, drive PWDN with a logic-low. It is recommended when using power-down that an RF signal not be applied before the power-down signal is low.

Applications Information

Detector (RSSI) Mode

In detector mode, the MAX2014 acts like an RSSI, which provides an output voltage proportional to the input power. This is accomplished by providing a feedback path from OUT to SET (R1 = 0Ω; see Figure 1).

By connecting SET directly to OUT, the op amp gain is set to 2V/V due to two internal 20kΩ feedback resistors.

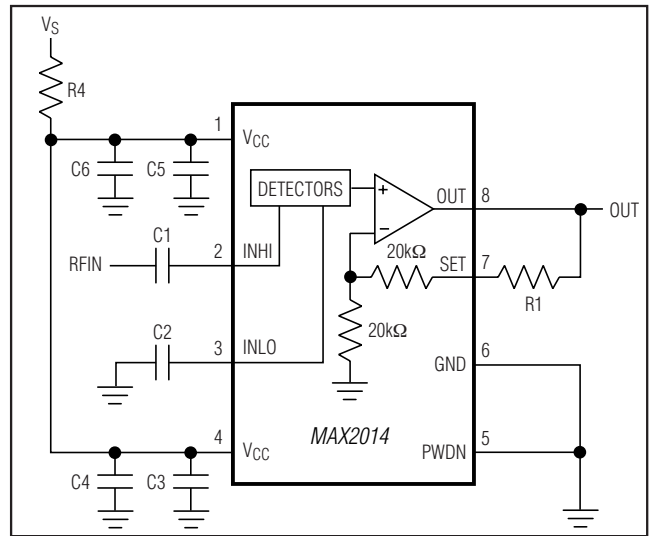

Figure 1. Detector-Mode (RSSI) Typical Application Circuit

Table 1. Suggested Components of Typical Application Circuits

DESIGNATION	VALUE	TYPE
C1, C2	680pF	0603 ceramic capacitors
C3, C5	100pF	0603 ceramic capacitors
C4, C6	0.1μF	0603 ceramic capacitors
R1*	0Ω	0603 resistor
R4**	0Ω	0603 resistor

*RSSI mode only.

**V_S = 2.7V to 3.6V.

This provides a detector slope of approximately 18mV/dB with a 0.5V to 1.8V output range.

Controller Mode

The MAX2014 can also be used as a detector/controller within an AGC loop. Figure 3 depicts one scenario where the MAX2014 is employed as the controller for a

50MHz to 1000MHz, 75dB Logarithmic Detector/Controller

variable-gain PA. As shown in the figure, the MAX2014 monitors the output of the PA through a directional coupler. An internal integrator (Figure 2) compares the detected signal with a reference voltage determined by V_{SET} . The integrator, acting like a comparator, increases or decreases the voltage at OUT, according to how closely the detected signal level matches the V_{SET} reference. The MAX2014 adjusts the power of the PA to a level determined by the voltage applied to SET. With $R1 = 0\Omega$, the controller mode slope is approximately 19mV/dB (RF = 100MHz).

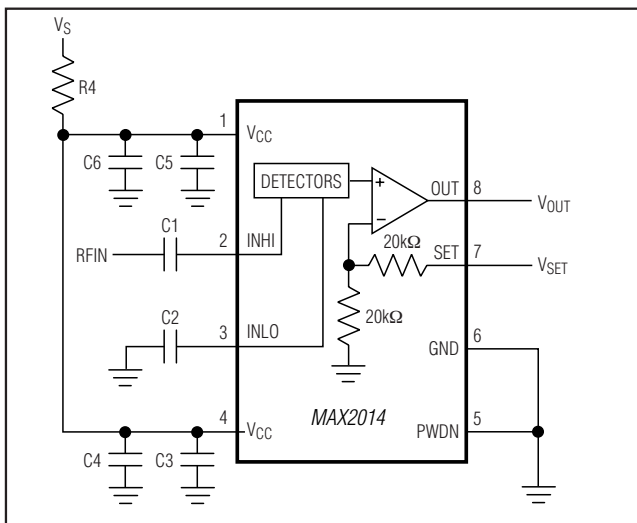

Figure 2. Controller-Mode Typical Application Circuit

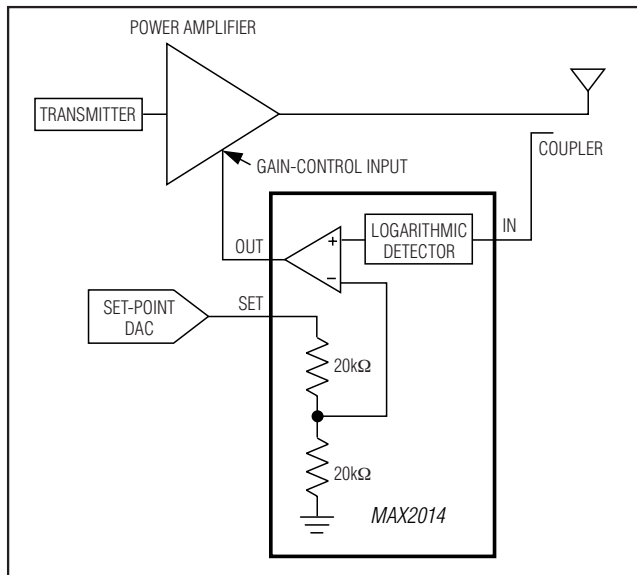
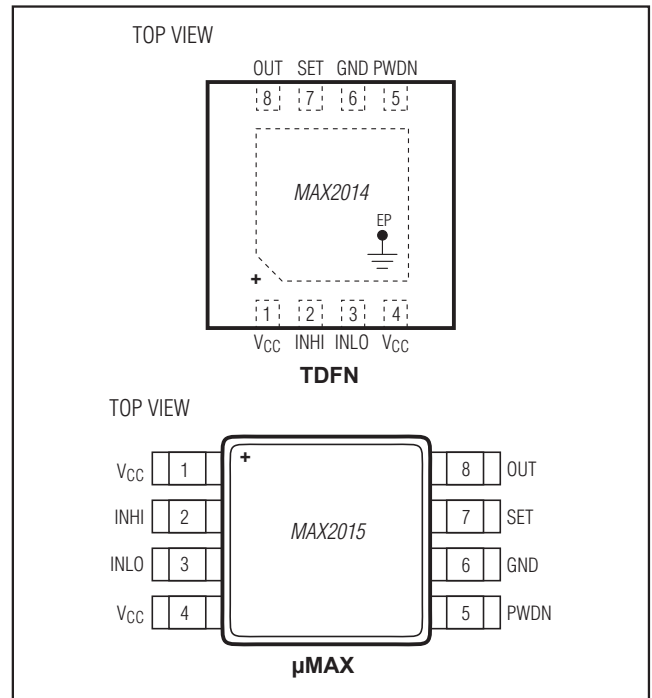

Figure 3. System Diagram for Automatic Gain-Control Loop

Layout Considerations

As with any RF circuit, the layout of the MAX2014 circuit affects the device's performance. Use an abundant number of ground vias to minimize RF coupling. Place the input capacitors (C1, C2) and the bypass capacitors (C3–C6) as close to the IC as possible. Connect the bypass capacitors to the ground plane with multiple vias.

Pin Configurations



50MHz to 1000MHz, 75dB Logarithmic Detector/Controller

MAX2014

Package Information

For the latest package outline information and land patterns (footprints), go to www.maxim-ic.com/packages. Note that a "+", "#", or "-" in the package code indicates RoHS status only. Package drawings may show a different suffix character, but the drawing pertains to the package regardless of RoHS status.

PACKAGE TYPE	PACKAGE CODE	OUTLINE NO.	LAND PATTERN NO.
8 TDFN-EP	T833+2	21-0137	90-0059
8 μ MAX	U8+1	21-0036	90-0092

Ordering Information

PART	TEMP RANGE	PIN-PACKAGE
MAX2014ETA+	-40°C to +85°C	8 TDFN-EP*
MAX2014ETA+T	-40°C to +85°C	8 TDFN-EP*
MAX2014EUA+	-40°C to +85°C	8 μ MAX
MAX2014EUA+T	-40°C to +85°C	8 μ MAX

+Denotes a lead(Pb)-free/RoHS-compliant package.

*EP = Exposed pad.

T = Tape and reel.

Chip Information

PROCESS: BiCMOS

50MHz to 1000MHz, 75dB Logarithmic Detector/Controller

Revision History

REVISION NUMBER	REVISION DATE	DESCRIPTION	PAGES CHANGED
0	6/06	Initial release	—
1	2/12	Added μ MAX package and updated style	1-7, 9, 10

Maxim cannot assume responsibility for use of any circuitry other than circuitry entirely embodied in a Maxim product. No circuit patent licenses are implied. Maxim reserves the right to change the circuitry and specifications without notice at any time. The parametric values (min and max limits) shown in the Electrical Characteristics table are guaranteed. Other parametric values quoted in this data sheet are provided for guidance.

12 **Maxim Integrated Products, 160 Rio Robles, San Jose, CA 95134 408-601-1000**