

ClockIt

Kit Information & Instructions



ClockIt is a clock with an alarm - short and sweet. For a beginner, expect to spend 20-30 minutes assembling the kit.

Based on the ATmega microcontroller, the code that runs ClockIt is available online. You can even reprogram ClockIt to be a count-down timer (for those bomb diffusing movie moments), a lovely egg timer, or any other device that requires a display, buzzer, and buttons (external programmer required).

Kit includes:

- 3/4" Female Standoff (quantity: 2)
- 22pF Cap (quantity: 2)
- 4 Digit Display
- ATmega microcontroller
- 5V Wall Wart
- Push Button (quantity: 3)
- 10 μ F Cap
- Resistor 10K Ohm
- Cap 0.1 μ F
- 1/4" Phillips Screw (quantity: 2)
- Mini Power Switch
- Buzzer
- Barrel Jack
- Crystal 16MHz

! SOLDERING TIPS

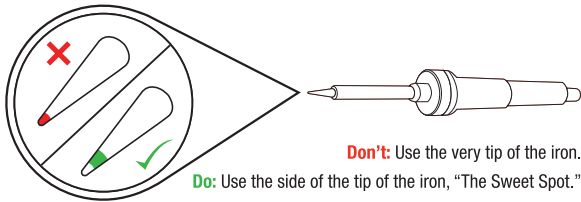

Don't: Use the very tip of the iron.

Do: Use the side of the tip of the iron, "The Sweet Spot."



Do: Touch the iron to the component leg and metal ring at the same time.



Do: While continuing to hold the iron in contact with the leg and metal ring, feed solder into the joint.

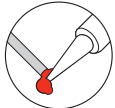

Don't: Glob the solder straight onto the iron and try to apply the solder with the iron.



Do: Use a sponge to clean your iron whenever black oxidization builds up on the tip.

! SOLDERING TIPS



A Solder flows around the leg and fills the hole - forming a volcano-shaped mound of solder.



B **Error:** Solder balls up on the leg, not connecting the leg to the metal ring.
Solution: Add flux, then touch up with iron.



C **Error:** Bad Connection (i.e. it doesn't look like a volcano)
Solution: Flux then add solder.



D **Error:** Bad Connection...and ugly...oh so ugly.
Solution: Flux then add solder.



E **Error:** Too much solder connecting adjacent legs (aka a solder jumper).
Solution: Wick off excess solder.

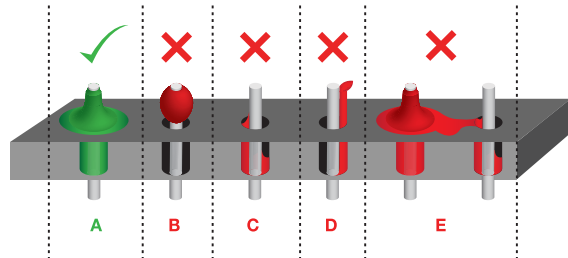

QUICKSTART - YOUR FIRST COMPONENT

[STEPS 1 TO 11]

- ① Locate the **10K Resistor**.



- ② Bend the legs downward.



- ③ Locate the **10K Resistor** position on the board.

TOP

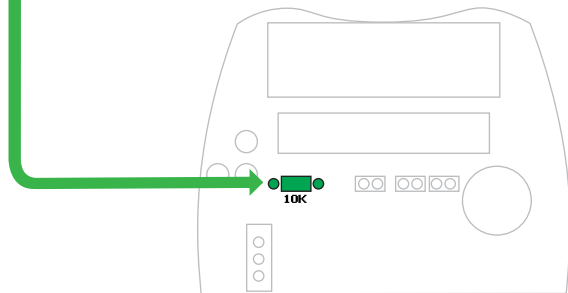

- ④ Insert the resistor into the PCB.

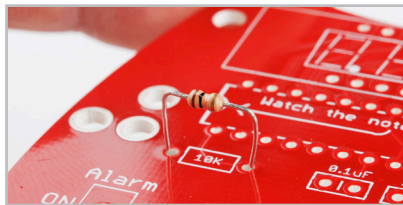

- ⑤ Push the resistor in so it is nearly flush with the board.

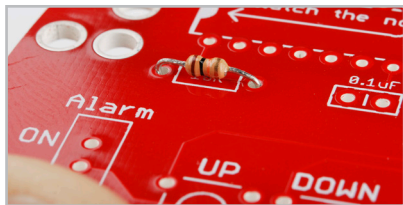

- ⑥ Flip board over and slightly bend the legs outward to hold it in place.

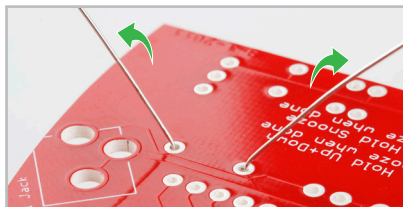

QUICKSTART - YOUR FIRST COMPONENT

[STEPS 1 TO 11]

- ⑦ Flip the board over. Hold the soldering iron's "Sweet Spot" so it touches both the leg and the metal ring. Hold for 2 seconds.



- ⑧ Feed solder into the joint.

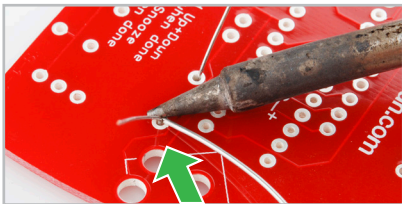

- ⑨ Pull solder away first.



- ⑩ Your solder joints should look like this - a tiny volcano.



- ⑪ Clip off any excess on the legs.

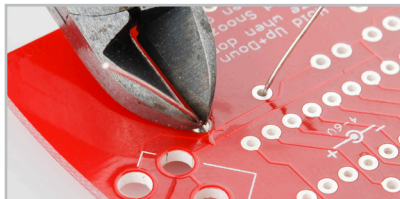



Now that you've successfully soldered in a resistor, use the same method to place and solder the rest of the components.

! EACH STEP HAS TWO PARTS

↑ START BY PLACING THE COMPONENT THROUGH THE **TOP SIDE OF THE BOARD.**

↓ TURN THE BOARD OVER TO SOLDER ON THE **BOTTOM SIDE OF THE BOARD.**



Steps highlighted with a yellow warning triangle represent a polarized component. Pay special attention to the component's markings indicating how to place it on the board.



12 0.1µF Cap

0.1µF Cap (decoupling cap): Marked "104." Make sure you solder the one 0.1µF Cap. Do not confuse it with the 22pF caps!



13 22pF Caps

22pF Caps (crystal caps): Marked "220."

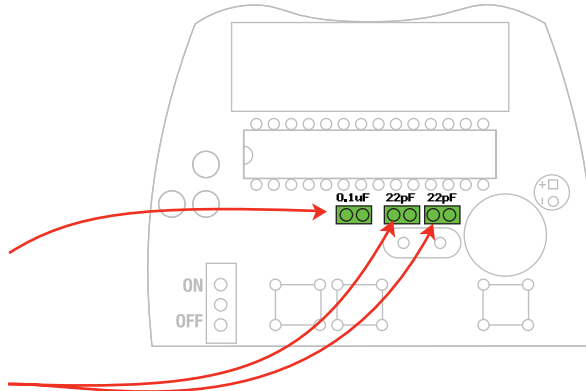



14 ATmega ⚠️

ATmega (microcontroller): Make sure the notch on the chip aligns with the notch on the board.



15 16MHz Crystal

16MHz Crystal (timing source)



16 Buttons x 3

Buttons (time input) - Push into place and solder.



17 10µF Cap ⚠️

10µF Cap (decoupling cap): Typically the cap has a gold negative sign '-' on the side. This aligns with the black '-' on the board. The short lead is the ground.

TOP OF BOARD

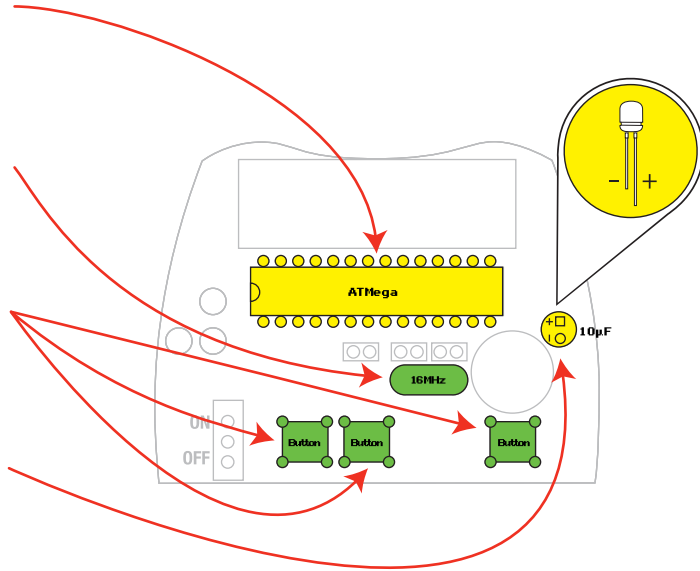

Remember highlighted components are polarized.



18 Display 

Display Match the dots on the display with the dots on the board. There is a decimal at the bottom of the board after each number.



19 Slide Switch

Slide Switch (alarm control): Keep iron tip away from top of switch! Plastic melts easily!



20 Buzzer

Buzzer (alarm): Remove the sticker that might be covering the buzzer.

TOP OF BOARD

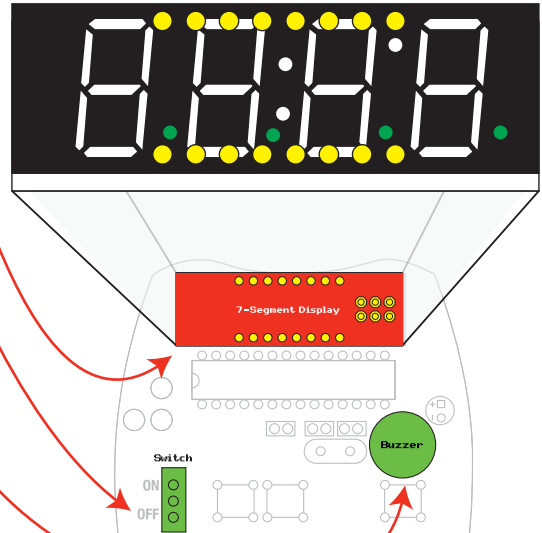

Remember highlighted components are polarized.

! WORK ON THE BOTTOM SIDE FOR THIS STEP ONLY



21 Power Jack

Power Jack (power): Solder this part through the **bottom** of the board. Follow steps A to C for further details.

BOTTOM

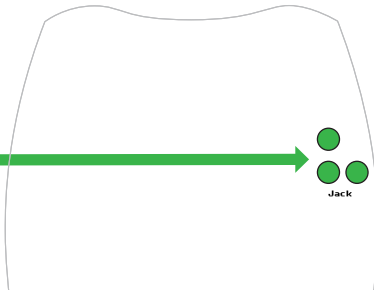

A Take your board and flip it over to the bottom side.

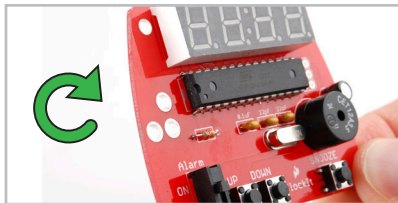

B This is the bottom side. Place PowerJack in flush to board.

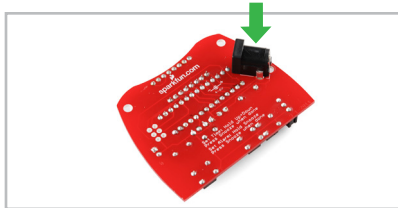

C Flip back to the top side of the board. Solder the Jack into place.



❗ TROUBLESHOOTING JUMPERS

Did you accidentally solder a jumper between two legs? Don't fret! Here is a simple process using solder wick to remove the excess solder.



I Locate a piece of solder wick.



II Place solder wick on top of solder.



III Place iron on top of solder wick. Hold for 3-4 seconds.

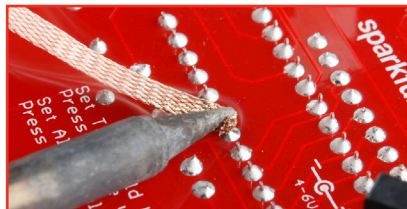

IV Once the solder begins to flow into the wick, pull the wick and iron away at the same time.



FINAL ASSEMBLY



No screwdriver necessary.
Please only hand-tighten the screws and standoffs.



Standoff & Phillips Screw (mechanical): Attach 2 corner standoffs with 2 screws. Hold the screw in place and twist standoff onto screw.

22 Standoffs & Screws



Plug in power and check to see if your blue display lights up.

23 Power Up!

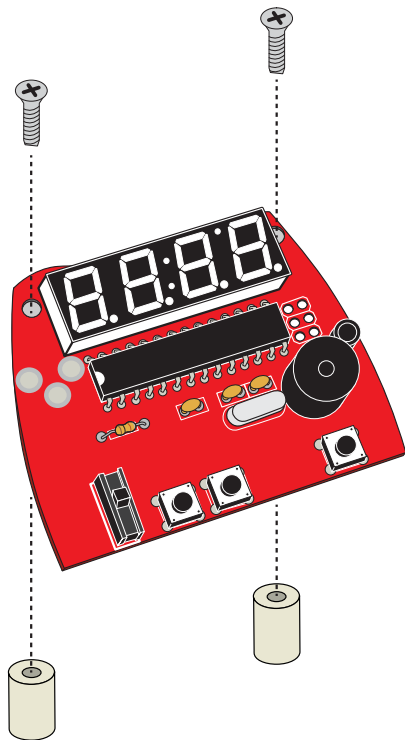

22

SETTING THE TIME

- 1 Hold Up and Down at the same time.

- 2 Use the Up and Down buttons to adjust the time.

- 3 Press Snooze when done.

SETTING THE ALARM

- 1 Hold Snooze.

- 2 Use the Up and Down buttons to adjust the time.

- 3 Press Snooze when done.