

# CGH40006P

6 W, RF Power GaN HEMT

## Description

WolfSpeed's CGH40006P is an unmatched, gallium nitride (GaN) high electron mobility transistor (HEMT). The CGH40006P, operating from a 28 volt rail, offers a general purpose, broadband solution to a variety of RF and microwave applications. GaN HEMTs offer high efficiency, high gain and wide bandwidth capabilities making the CGH40006P ideal for linear and compressed amplifier circuits. The transistor is available in a solder-down, pill package.



Package Type: 440109  
PN: CGH40006P

## Features

- Up to 6 GHz Operation
- 13 dB Small Signal Gain at 2.0 GHz
- 11 dB Small Signal Gain at 6.0 GHz
- 8 W typical at  $P_{IN} = 32$  dBm
- 28 V Operation

## Applications

- 2-Way Private Radio
- Broadband Amplifiers
- Cellular Infrastructure
- Test Instrumentation
- Class A, AB, amplifiers suitable for OFDM, W-CDMA, EDGE, CDMA waveforms



Large Signal Models Available for ADS and MWO





## Absolute Maximum Ratings (not simultaneous) at 25°C Case Temperature

Parameter	Symbol	Rating	Units	Conditions
Drain-Source Voltage	$V_{DSS}$	120	V	25°C
Gate-to-Source Voltage	$V_{GS}$	-10, +2		
Storage Temperature	$T_{STG}$	-65, +150	°C	
Operating Junction Temperature	$T_J$	225		
Maximum Forward Gate Current	$I_{GMAX}$	2.1	mA	25°C
Maximum Drain Current <sup>1</sup>	$I_{DMAX}$	0.75		
Soldering Temperature <sup>2</sup>	$T_S$	245	°C	
Thermal Resistance, Junction to Case <sup>3</sup>	$R_{\theta JC}$	9.5	°C/W	85°C
Case Operating Temperature <sup>3</sup>	$T_C$	-40, +150	°C	

Notes:

<sup>1</sup> Current limit for long term, reliable operation

<sup>2</sup> Refer to the Application Note on soldering at [wolfspeed.com/rf/document-library](http://wolfspeed.com/rf/document-library)

<sup>3</sup> Measured for the CGH40006P at  $P_{DISS} = 8$  W.

## Electrical Characteristics ( $T_C = 25^\circ\text{C}$ )

Characteristics	Symbol	Min.	Typ.	Max.	Units	Conditions
<b>DC Characteristics<sup>1</sup></b>						
Gate Threshold Voltage	$V_{GS(th)}$	-3.8	-3.0	-2.3	$V_{DC}$	$V_{DS} = 10$ V, $I_D = 2.1$ mA
Gate Quiescent Voltage	$V_{GS(Q)}$	—	-2.7	—		$V_{DS} = 28$ V, $I_D = 100$ mA
Saturated Drain Current	$I_{DS}$	1.5	2.1	—	A	$V_{DS} = 6.0$ V, $V_{GS} = 2.0$ V
Drain-Source Breakdown Voltage	$V_{BR}$	84	—	—	$V_{DC}$	$V_{GS} = -8$ V, $I_D = 2.1$ mA
<b>RF Characteristics<sup>2</sup> (<math>T_C = 25^\circ\text{C}</math>, <math>F_0 = 2.0</math> GHz unless otherwise noted)</b>						
Small Signal Gain	$G_{SS}$	11.5	13	—	dB	$V_{DD} = 28$ V, $I_{DQ} = 100$ mA
Power Output at $P_{IN} = 32$ dBm	$P_{OUT}$	7.0	9	—	W	
Drain Efficiency <sup>3</sup>	$\eta$	53	65	—	%	$V_{DD} = 28$ V, $I_{DQ} = 100$ mA, $P_{IN} = 32$ dBm
Output Mismatch Stress	VSWR	—	—	10:1	$\Psi$	No damage at all phase angles, $V_{DD} = 28$ V, $I_{DQ} = 100$ mA, $P_{IN} = 32$ dBm
<b>Dynamic Characteristics</b>						
Input Capacitance	$C_{GS}$	—	3.0	—	pF	$V_{DS} = 28$ V, $V_{GS} = -8$ V, $f = 1$ MHz
Output Capacitance	$C_{DS}$	—	1.1	—		
Feedback Capacitance	$C_{GD}$	—	0.1	—		

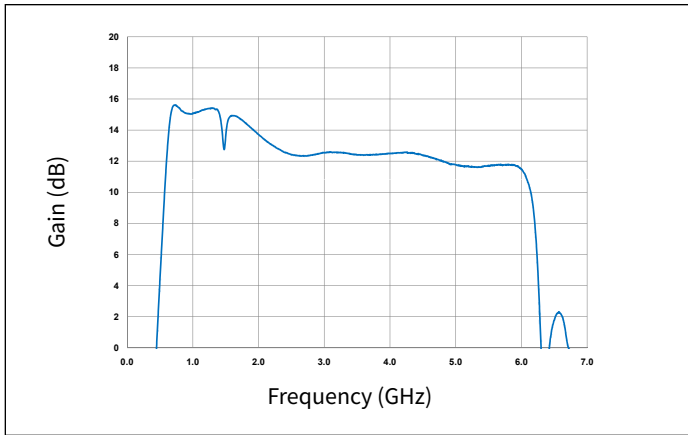
Notes:

<sup>1</sup> Measured on wafer prior to packaging.

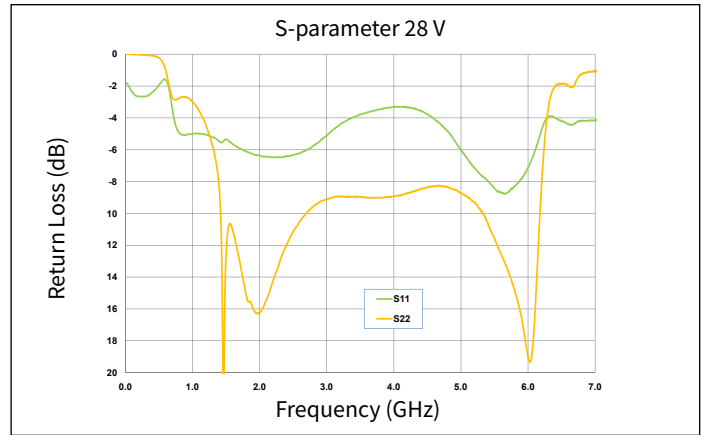
<sup>2</sup> Measured in the CGH40006P-AMP

<sup>3</sup> Drain Efficiency =  $P_{OUT} / P_{DC}$

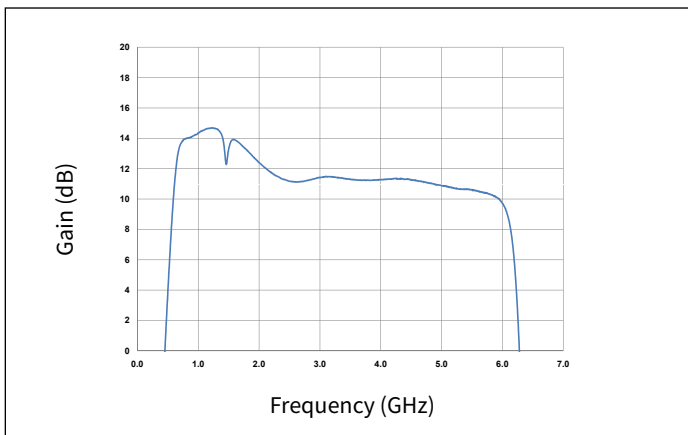
## Typical Performance



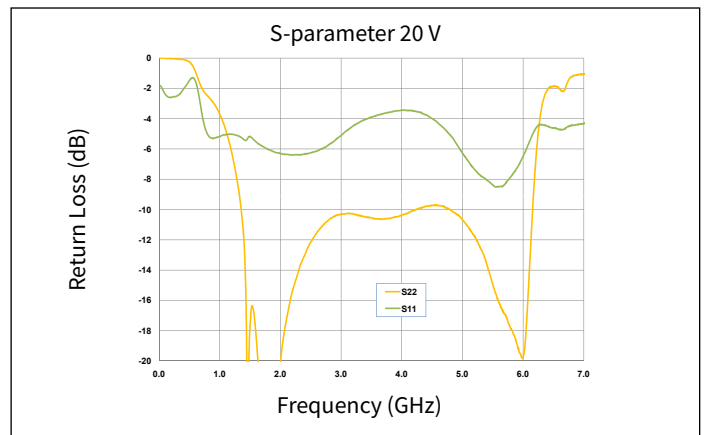
**Figure 1.** Small Signal Gain vs Frequency at 28 V of the CGH40006P in the CGH40006P-AMP



**Figure 2.** Input & Output Return Losses vs Frequency at 28 V of the CGH40006P in the CGH40006P-AMP



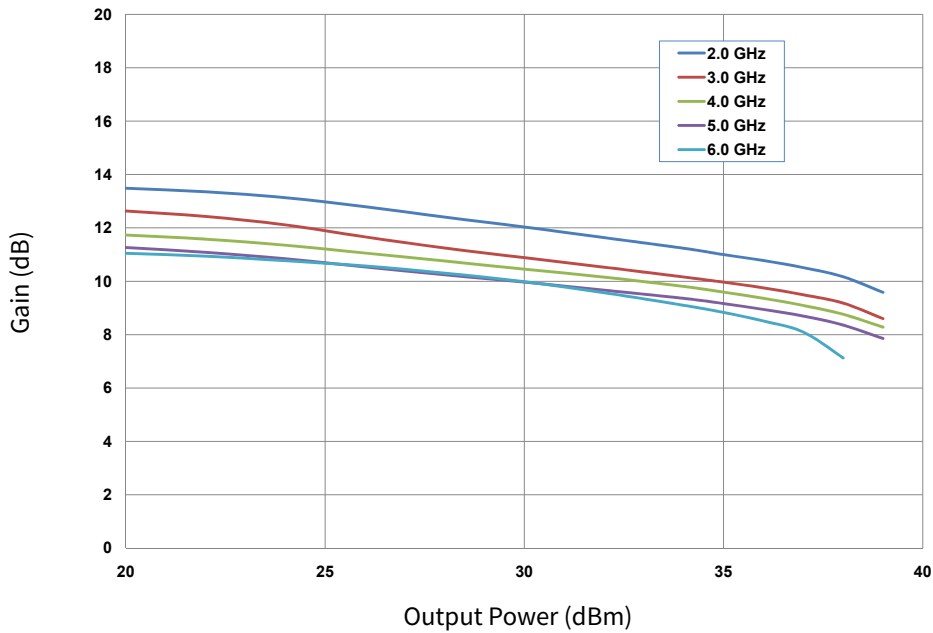
**Figure 3.** Small Signal Gain vs Frequency at 20 V of the CGH40006P in the CGH40006P-AMP



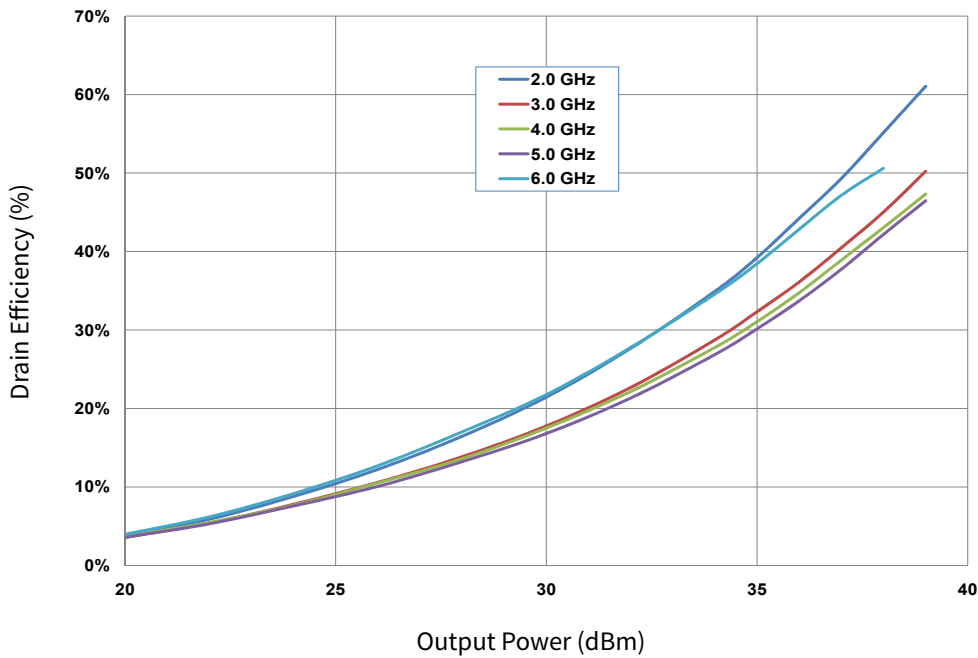
**Figure 4.** Input & Output Return Losses vs Frequency at 20 V of the CGH40006P in the CGH40006P-AMP



Typical Performance



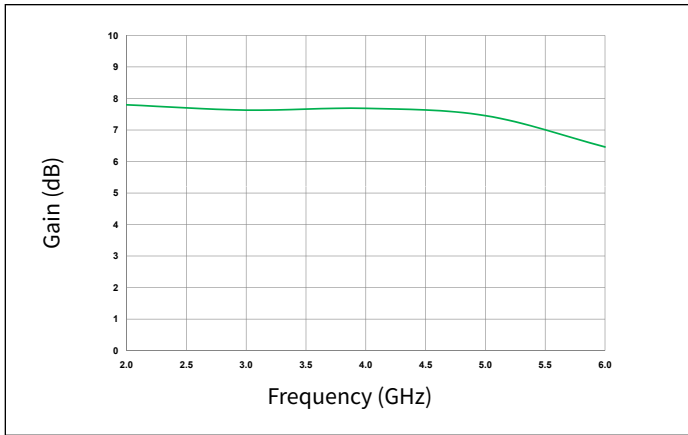
**Figure 5.** Power Gain vs Output Power as a Function of Frequency of the CGH40006P in the CGH40006P-AMP  
 $V_{DD} = 28\text{ V}$ ,  $I_{DQ} = 100\text{ mA}$



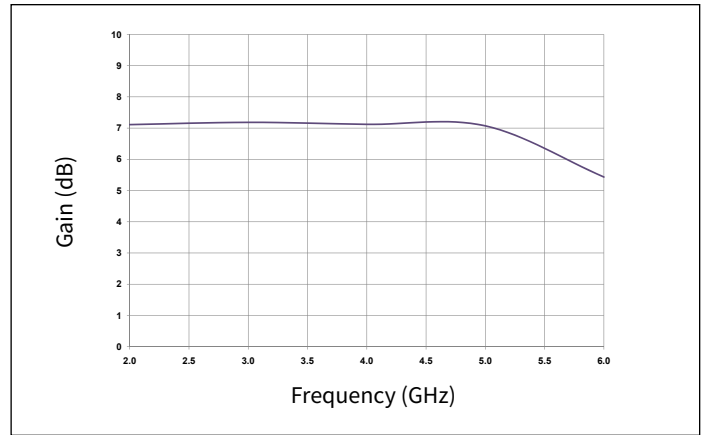
**Figure 6.** Drain Efficiency vs Output Power as a Function of Frequency of the CGH40006P in the CGH40006P-AMP  
 $V_{DD} = 28\text{ V}$ ,  $I_{DQ} = 100\text{ mA}$



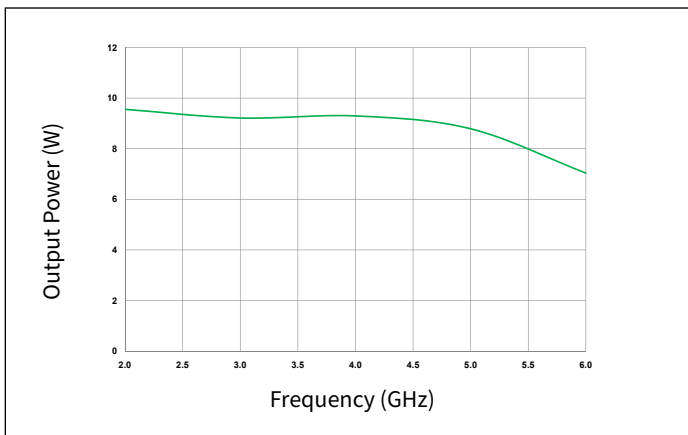
Typical Performance



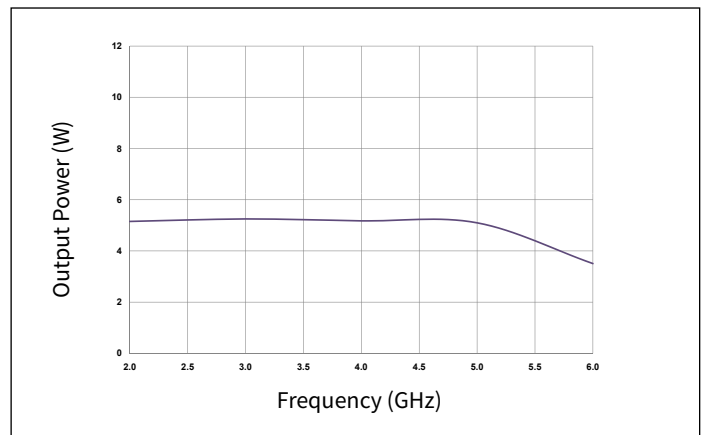
**Figure 7.** Small Signal Gain vs Frequency at 28 V in the CGH40006P-AMP  
 $P_{IN} = 32 \text{ dBm}$ ,  $V_{DD} = 28 \text{ V}$



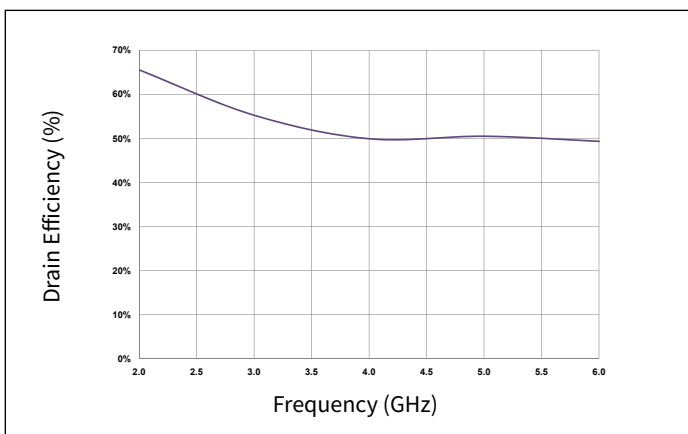
**Figure 8.** Power Gain vs Frequency of the CGH40006P in the CGH40006P-AMP  
 $P_{IN} = 30 \text{ dBm}$ ,  $V_{DD} = 20 \text{ V}$



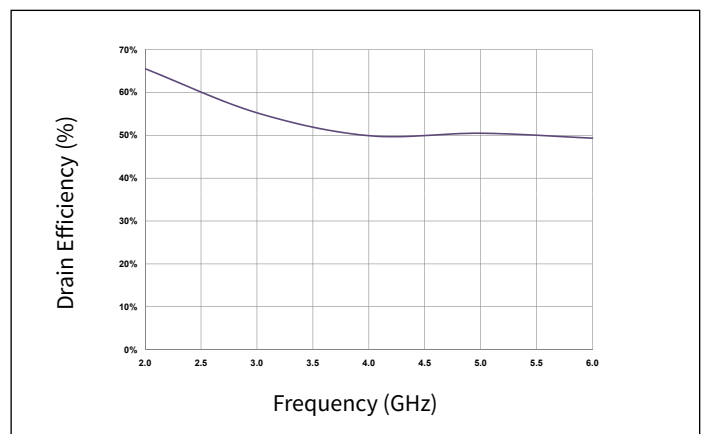
**Figure 9.** Output Power vs Frequency of the CGH40006P in the CGH40006P-AMP  
 $P_{IN} = 32 \text{ dBm}$ ,  $V_{DD} = 28 \text{ V}$



**Figure 10.** Output Power vs Frequency of the CGH40006P in the CGH40006P-AMP  
 $P_{IN} = 30 \text{ dBm}$ ,  $V_{DD} = 20 \text{ V}$



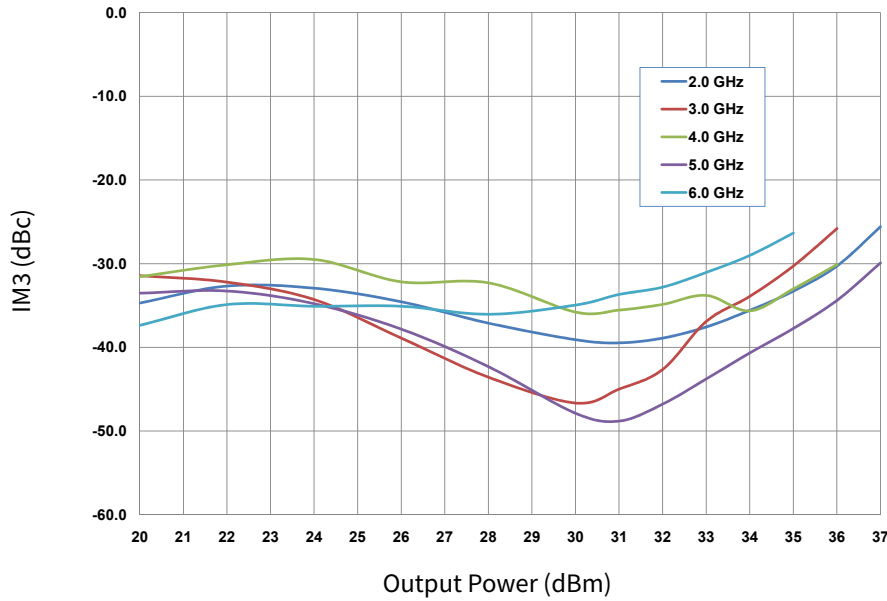
**Figure 11.** Drain Efficiency vs Frequency of the CGH40006P in the CGH40006P-AMP  
 $P_{IN} = 32 \text{ dBm}$ ,  $V_{DD} = 28 \text{ V}$



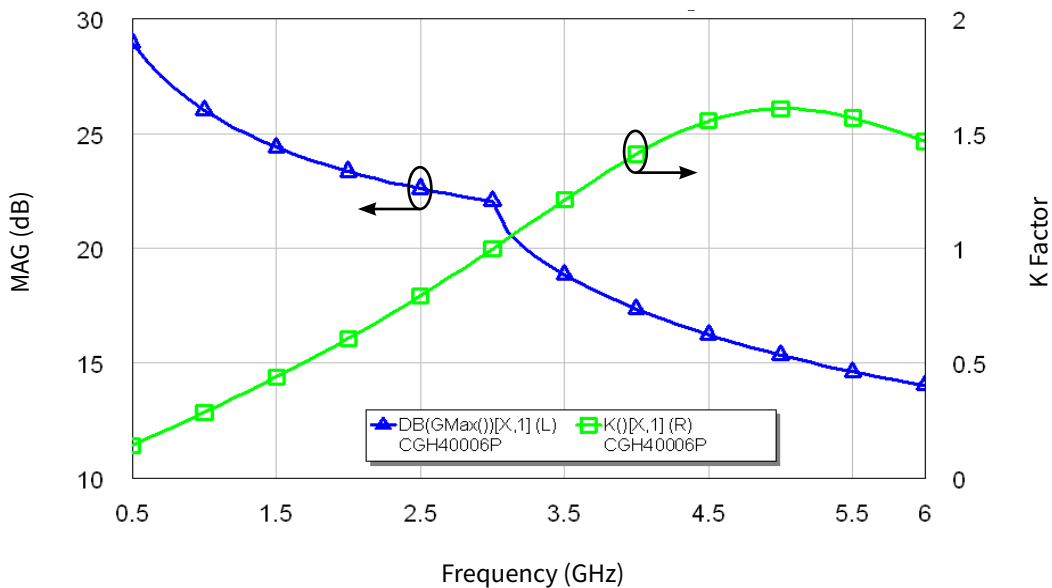
**Figure 12.** Drain Efficiency vs Frequency of the CGH40006P in the CGH40006P-AMP  
 $P_{IN} = 30 \text{ dBm}$ ,  $V_{DD} = 20 \text{ V}$



Typical Performance

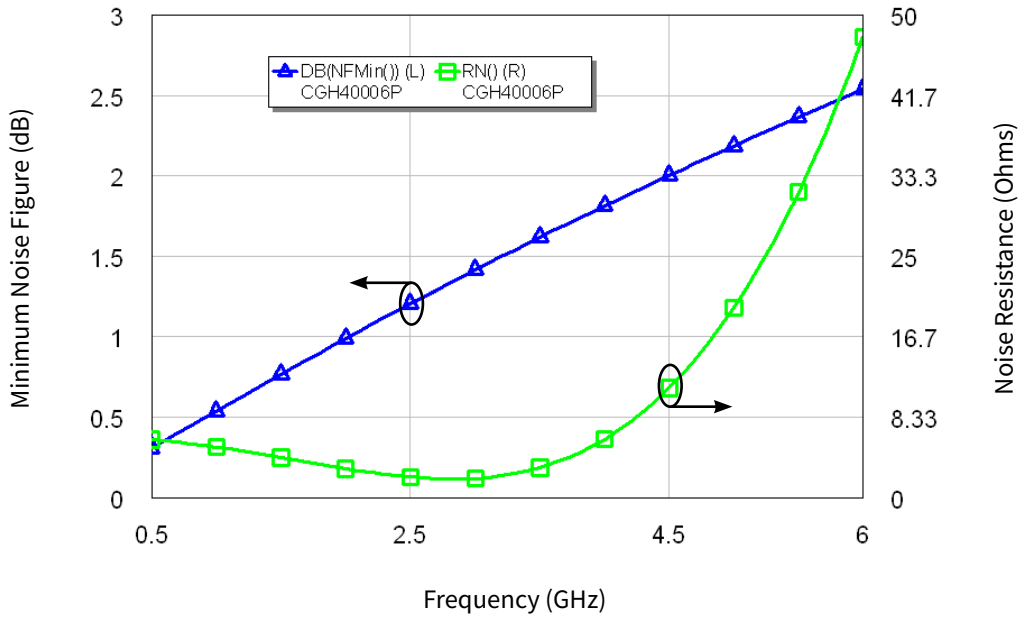


**Figure 13.** Third Order Intermodulation Distortion vs Average Output Power as a Function of Frequency of the CGH40006P in the CGH40006P-AMP  
 $V_{DD} = 28\text{ V}$ ,  $I_{DQ} = 60\text{ mA}$



**Figure 14.** Simulated Maximum Available Gain and K Factor of the CGH40006P  
 $V_{DD} = 28\text{ V}$ ,  $I_{DQ} = 100\text{ mA}$

### Typical Noise Performance



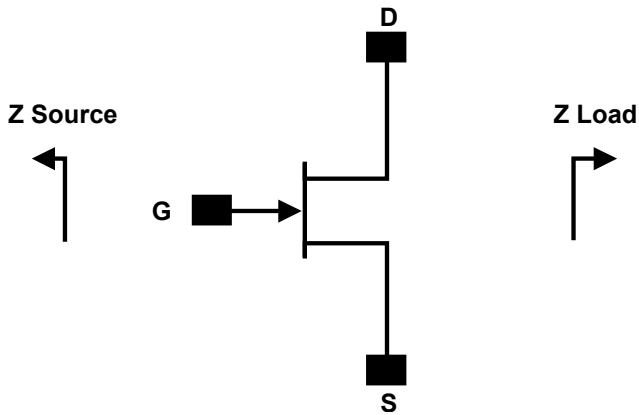
**Figure 15.** Simulated Minimum Noise Figure and Noise Resistance vs Frequency of the CGH40006P  
 $V_{DD} = 28\text{ V}$ ,  $I_{DQ} = 100\text{ mA}$

### Electrostatic Discharge (ESD) Classifications

Parameter	Symbol	Class	Classification Level	Test Methodology
Human Body Model	HBM	1B	ANSI/ESDA/JEDEC JS-001 Table 3	JEDEC JESD22 A114-D
Charge Device Model	CDM	C3	ANSI/ESDA/JEDEC JS-001 Table 3	JEDEC JESD22 C101-C



### Source and Load Impedances



Frequency (MHz)	Z Source	Z Load
1000	13.78 + j6.9	61.5 + j47.4
2000	4.78 + j1.78	19.4 + j39.9
3000	2.57 - j6.94	12.57 + j23.1
4000	3.54 - j14.86	9.44 + j11.68
5000	4.42 - j25.8	9.78 + j4.85
6000	7.1 - j42.7	9.96 - j4.38

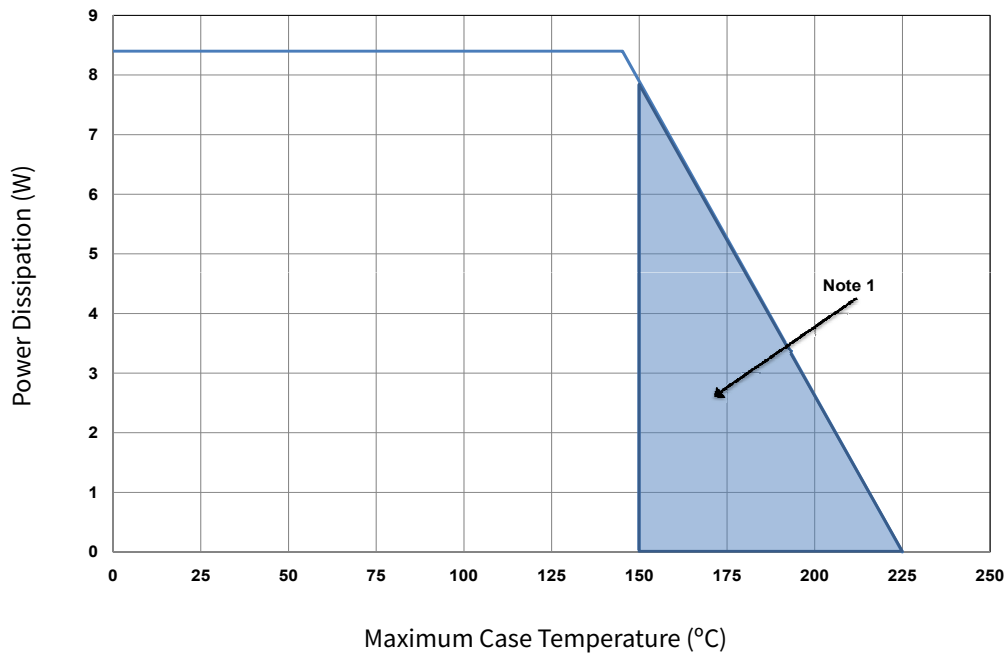
Notes:

<sup>1</sup>  $V_{DD} = 28V, I_{DQ} = 100mA$  in the 440109 package

<sup>2</sup> Optimized for power gain,  $P_{SAT}$  and PAE

<sup>3</sup> When using this device at low frequency, series resistors should be used to maintain amplifier stability

### CGH40006P Power Dissipation De-rating Curve



Note:

<sup>1</sup> Area exceeds Maximum Case Operating Temperature (See Page 2).

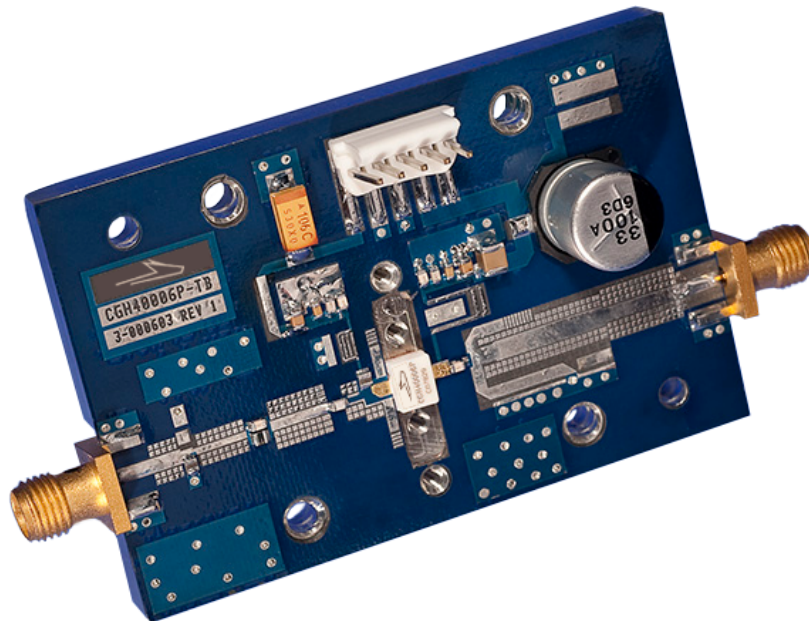




## CGH40006P-AMP Demonstration Amplifier Circuit Bill of Materials

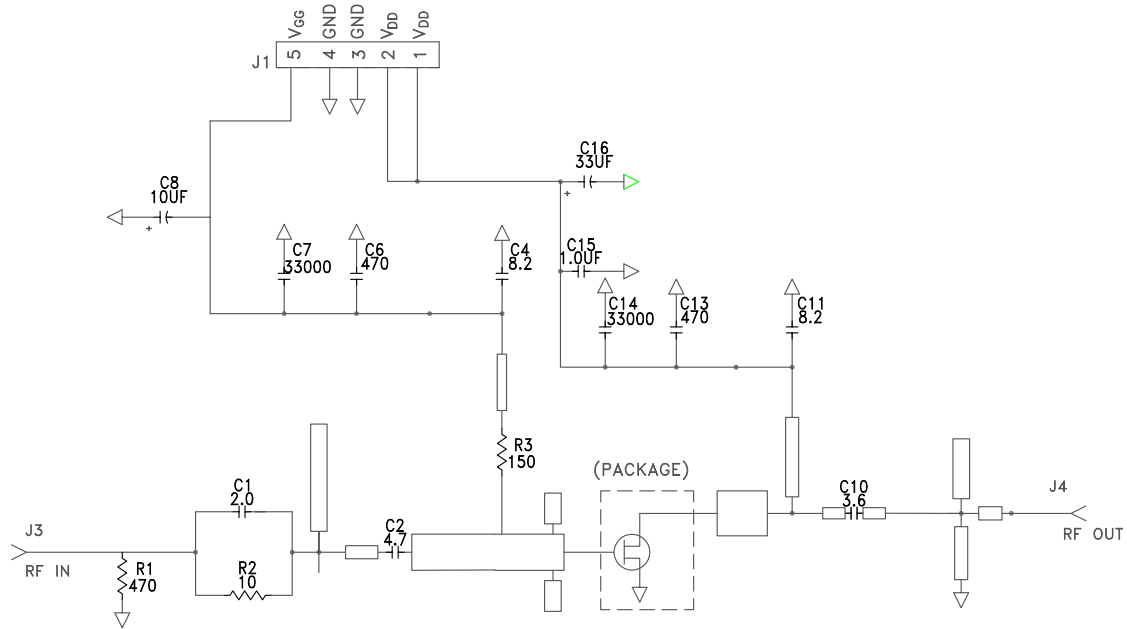
Designator	Description	Qty
R1	RES, AIN, 0505, 470 Ohms ( $\leq 5\%$ tolerance)	1
R2	RES, AIN, 0505, 10 Ohms ( $\leq 5\%$ tolerance)	1
R3	RES, AIN, 0505, 150 Ohms ( $\leq 5\%$ tolerance)	1
C1	CAP, 2.0pF +/-0.1pF, 0603, ATC 600S	1
C2	CAP, 4.7pF +/-0.1pF, 0603, ATC 600S	1
C10	CAP, 3.6pF +/-0.1pF, 0603, ATC 600S	1
C4, C11	CAP, 8.2pF +/-0.25, 0603, ATC 600S	2
C6, C13	CAP, 470pF +/-5%, 0603, 100 V	2
C7, C14	CAP, 33000pF, CER, 100V, X7R, 0805	2
C8	CAP, 10 $\mu$ F, 16V, SMT, TANTALUM	1
C15	CAP, 1.0 $\mu$ F +/-10%, CER, 100V, X7R, 1210	1
C16	CAP, 33 $\mu$ F, 100V, ELECT, FK, SMD	1
J3, J4	CONN, SMA, STR, PANEL, JACK, RECP	2
J1	HEADER RT>PLZ .1CEN LK 5POS	1
-	PCB, RO5880, 20 MIL	1
Q1	CGH40006P	1

## CGH40006P-AMP Demonstration Amplifier Circuit

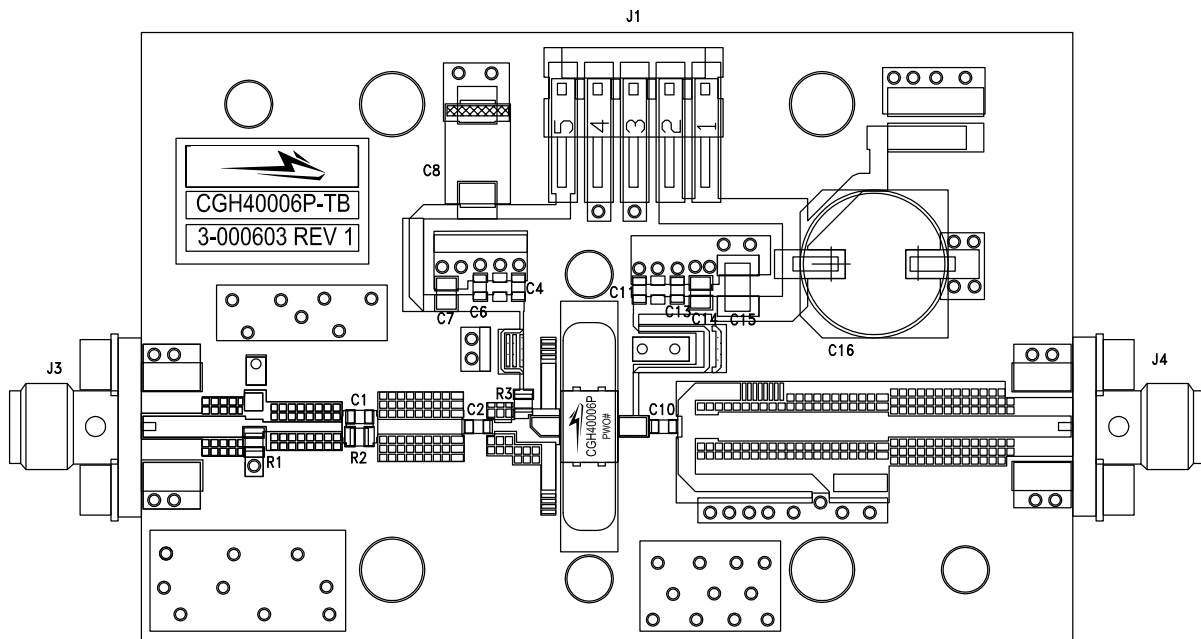




**CGH40006P-AMP Demonstration Amplifier Circuit Schematic**



**CGH40006P-AMP Demonstration Amplifier Circuit Outline**





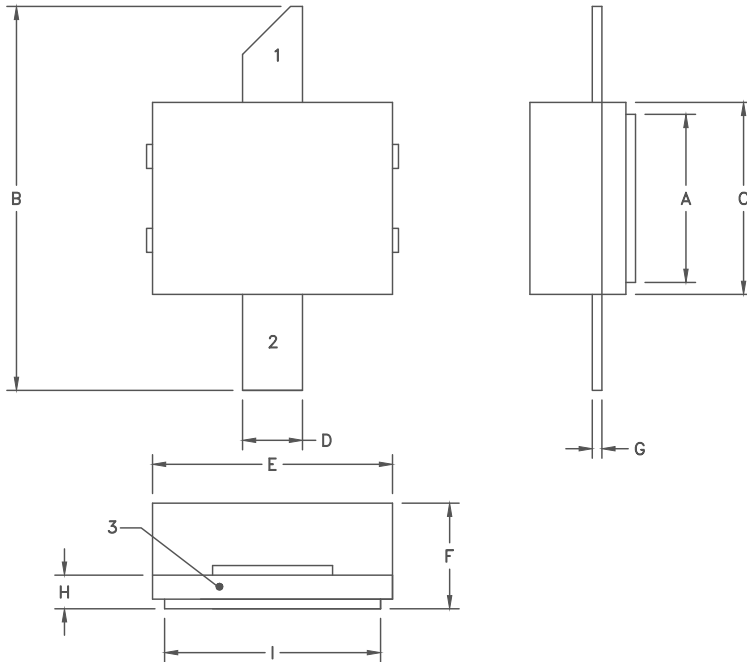
### Typical Package S-Parameters for CGH40006P (Small Signal, $V_{DS} = 28\text{ V}$ , $I_{DQ} = 100\text{ mA}$ , angle in degrees)

Frequency	Mag S11	Ang S11	Mag S21	Ang S21	Mag S12	Ang S12	Mag S22	Ang S22
500 MHz	0.905	-96.56	18.30	120.62	0.023	35.87	0.456	-52.76
600 MHz	0.889	-107.98	16.39	113.31	0.025	29.63	0.429	-58.98
700 MHz	0.877	-117.55	14.76	106.99	0.026	24.39	0.408	-64.31
800 MHz	0.867	-125.66	13.37	101.43	0.027	19.92	0.393	-68.96
900 MHz	0.860	-132.61	12.19	96.46	0.028	16.05	0.381	-73.11
1.0 GHz	0.854	-138.66	11.18	91.94	0.028	12.66	0.374	-76.87
1.1 GHz	0.849	-143.98	10.31	87.79	0.028	9.64	0.368	-80.34
1.2 GHz	0.845	-148.73	9.56	83.92	0.028	6.92	0.366	-83.57
1.3 GHz	0.842	-153.01	8.90	80.29	0.028	4.46	0.365	-86.61
1.4 GHz	0.839	-156.90	8.33	76.84	0.028	2.22	0.365	-89.49
1.5 GHz	0.837	-160.49	7.82	73.56	0.028	0.15	0.367	-92.24
1.6 GHz	0.835	-163.81	7.37	70.40	0.028	-1.75	0.369	-94.88
1.7 GHz	0.833	-166.92	6.96	67.36	0.028	-3.51	0.373	-97.43
1.8 GHz	0.832	-169.85	6.60	64.41	0.028	-5.15	0.376	-99.88
1.9 GHz	0.830	-172.62	6.27	61.54	0.028	-6.67	0.381	-102.27
2.0 GHz	0.829	-175.27	5.98	58.74	0.028	-8.08	0.386	-104.58
2.1 GHz	0.828	-177.81	5.71	56.00	0.028	-9.40	0.391	-106.84
2.2 GHz	0.827	179.75	5.46	53.32	0.027	-10.61	0.396	-109.04
2.3 GHz	0.826	177.38	5.24	50.68	0.027	-11.73	0.401	-111.19
2.4 GHz	0.825	175.07	5.03	48.09	0.027	-12.77	0.407	-113.29
2.5 GHz	0.824	172.82	4.84	45.53	0.027	-13.71	0.412	-115.36
2.6 GHz	0.823	170.61	4.67	43.00	0.026	-14.57	0.418	-117.38
2.7 GHz	0.821	168.44	4.51	40.50	0.026	-15.34	0.423	-119.36
2.8 GHz	0.820	166.30	4.36	38.02	0.026	-16.02	0.428	-121.32
2.9 GHz	0.819	164.18	4.22	35.57	0.026	-16.62	0.434	-123.24
3.0 GHz	0.818	162.08	4.09	33.13	0.026	-17.13	0.439	-125.13
3.2 GHz	0.816	157.91	3.85	28.31	0.025	-17.89	0.449	-128.84
3.4 GHz	0.813	153.76	3.65	23.53	0.025	-18.30	0.458	-132.46
3.6 GHz	0.810	149.58	3.47	18.78	0.025	-18.38	0.467	-136.00
3.8 GHz	0.807	145.35	3.31	14.05	0.024	-18.13	0.474	-139.48
4.0 GHz	0.804	141.05	3.18	9.32	0.024	-17.60	0.481	-142.91
4.2 GHz	0.801	136.66	3.05	4.57	0.024	-16.82	0.488	-146.30
4.4 GHz	0.797	132.15	2.94	-0.20	0.025	-15.89	0.493	-149.67
4.6 GHz	0.793	127.50	2.85	-5.01	0.025	-14.87	0.497	-153.02
4.8 GHz	0.789	122.70	2.76	-9.86	0.026	-13.89	0.500	-156.37
5.0 GHz	0.785	117.72	2.68	-14.79	0.027	-13.04	0.503	-159.74
5.2 GHz	0.780	112.55	2.62	-19.78	0.029	-12.42	0.504	-163.14
5.4 GHz	0.776	107.17	2.55	-24.86	0.030	-12.13	0.505	-166.59
5.6 GHz	0.772	101.58	2.50	-30.03	0.032	-12.22	0.504	-170.10
5.8 GHz	0.768	95.76	2.44	-35.30	0.035	-12.75	0.503	-173.70
6.0 GHz	0.764	89.70	2.40	-40.69	0.037	-13.73	0.501	-177.41

To download the s-parameters in s2p format, go to the [CGH40006P Product Page](#) and click on the documentation tab.



**Product Dimensions CGH40006P (Package Type — 440109)**



NOTES: (UNLESS OTHERWISE SPECIFIED)

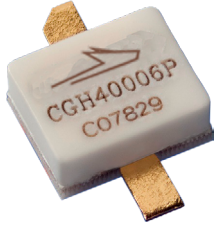
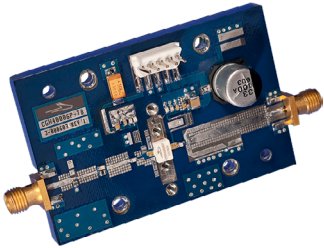
1. INTERPRET DRAWING IN ACCORDANCE WITH ANSI Y14.5M-1982 DIMENSIONING AND TOLERANCING.
2. CONTROLLING DIMENSION: INCH.
3. ALL PLATED SURFACES ARE Ni/Au

DIM	INCHES		MILLIMETERS	
	MIN	MAX	MIN	MAX
A	.135	.145	3.43	3.68
B	.315	.325	8.00	8.26
C	.155	.165	3.94	4.19
D	.045	.055	1.14	1.40
E	.195	.205	4.95	5.21
F	.085	.104	2.15	2.65
G	.007	.009	.178	0.23
H	.026	.030	.660	.762
I	.175	.185	4.45	4.70

- PIN 1. GATE
- PIN 2. DRAIN
- PIN 3. SOURCE



**Product Ordering Information**

Order Number	Description	Unit of Measure	Image
CGH40006P	GaN HEMT	Each	 A small, white, rectangular GaN HEMT component with two gold-colored leads extending from the top and bottom. The component is marked with the Wolfstreak logo and the text 'CGH40006P' and 'C07829'.
CGH40006P-AMP	Test board with GaN HEMT installed	Each	 A blue printed circuit board (PCB) test board with various electronic components, including a GaN HEMT component, capacitors, and connectors. It features two SMA connectors on the right side.

**For more information, please contact:**

4600 Silicon Drive  
Durham, NC 27703 USA  
Tel: +1.919.313.5300  
[www.wolfspeed.com/RF](http://www.wolfspeed.com/RF)

Sales Contact  
[RFSales@wolfspeed.com](mailto:RFSales@wolfspeed.com)

RF Product Marketing Contact  
[RFMarketing@wolfspeed.com](mailto:RFMarketing@wolfspeed.com)

## Notes & Disclaimer

---

Specifications are subject to change without notice. “Typical” parameters are the average values expected by Wolfspeed in large quantities and are provided for information purposes only. Wolfspeed products are not warranted or authorized for use as critical components in medical, life-saving, or life-sustaining applications, or other applications where a failure would reasonably be expected to cause severe personal injury or death. No responsibility is assumed by Wolfspeed for any infringement of patents or other rights of third parties which may result from use of the information contained herein. No license is granted by implication or otherwise under any patent or patent rights of Wolfspeed.

©2009-2022 Wolfspeed, Inc. All rights reserved. Wolfspeed® and the Wolfstreak logo are registered trademarks and the Wolfspeed logo is a trademark of Wolfspeed, Inc.  
PATENT: <https://www.wolfspeed.com/legal/patents>

*The information in this document is subject to change without notice.*