

FEATURES

- 2-axis light angle measurement**
- Linear response to the angle of incident light**
- Integrated visible light blocking optical filter**
- No external lens required**
- Low diode capacitance: 15.4 pF per channel at $V_R = 0.25\text{ V}$**
- Low reverse dark current: 786 fA per channel at $V_R = 0.25\text{ V}$, $T_A = 25^\circ\text{C}$**
- 8-lead, 2 mm × 3 mm, 0.65 mm height LFCSP**
- AEC-Q100 qualified for automotive applications**

APPLICATIONS

- Gesture for user interface control**
- Light angle sensing**
- Proximity sensing**

GENERAL DESCRIPTION

The ADPD2140W is an optical sensor that detects and measures the angle of incident infrared light within a wide field of view and can be used in conjunction with an infrared light emitting diode (LED) to detect user hand movements or gestures.

The ADPD2140W has an illuminated, radiant sensitive area of 0.363 mm^2 . The low diode capacitance and low dark current of the ADPD2140W allows optimal integration with the [ADPD1080](#)

FUNCTIONAL BLOCK DIAGRAM

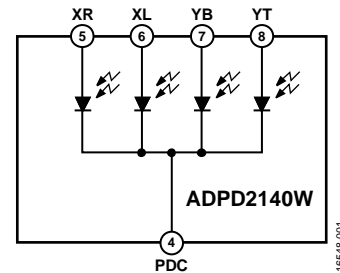

Figure 1.

photometric front end. The ADPD2140W requires four photodiode channels. Therefore it is recommended to use the [ADPD1080BCPZ](#) with the ADPD2140W.

Packaged in a small, clear mold, 2 mm × 3 mm, 8-lead LFCSP, the ADPD2140W is specified over the -40°C to $+105^\circ\text{C}$ operating temperature range.

TABLE OF CONTENTS

Features	1	Typical Performance Characteristics	6
Applications	1	Theory of Operation	7
Functional Block Diagram	1	Angular Response	7
General Description	1	Typical Connection Diagram	7
Revision History	2	Applications Information	8
Specifications	3	Gesture Recognition	8
Absolute Maximum Ratings	4	Outline Dimensions	9
Thermal Resistance	4	Ordering Guide	10
Soldering Profile	4	Automotive Products	10
ESD Caution	4		
Pin Configuration and Function Descriptions	5		

REVISION HISTORY

12/2018—Revision 0: Initial Version

SPECIFICATIONS

All specifications listed for the sum of all four photodiode channels, unless otherwise noted.

Table 1.

Parameter	Symbol	Test Conditions/Comments	Min	Typ	Max	Unit
OPTICAL/ELECTRICAL CHARACTERISTICS						
Infrared Light Responsivity	S_{880}	$\lambda = 880 \text{ nm}$, illuminated area (A) = 0.363 mm ² , incident angle (θ) = 0°		0.40		A/W
Visible Light Responsivity	S_{940}	$\lambda = 940 \text{ nm}$, A = 0.363 mm ² , $\theta = 0^\circ$		0.30		A/W
	S_{660}	$\lambda = 660 \text{ nm}$, A = 0.363 mm ² , $\theta = 0^\circ$		0.025		A/W
Temperature Coefficient of Infrared Light Responsivity	K_{880}	$\lambda = 880 \text{ nm}$, $-40^\circ\text{C} < T_A < +105^\circ\text{C}$		0.178		%/K
Reverse Dark Current per Channel ¹	I_D	Reverse voltage (V_R) = 0.25 V, $T_A = 25^\circ\text{C}$		786		fA
Diode Capacitance per Channel	C_D	$V_R = 0.25 \text{ V}$, frequency = 100 kHz, test voltage (V_{TEST}) = 50 mV		15.4		pF
Rise Time (20% to 80%)	t_R	$V_R = 0.25 \text{ V}$, $\lambda = 880 \text{ nm}$, $T_A = 25^\circ\text{C}$		258		ns
Fall Time (20% to 80%)	t_F	$V_R = 0.25 \text{ V}$, $\lambda = 880 \text{ nm}$, $T_A = 25^\circ\text{C}$		260		ns
Forward Voltage	V_F	Forward current (I_F) = 2 μA		0.525		V
OPERATING SPECIFICATIONS						
Bias Voltage (Any Channel)	V_B		-1		+0.1	V
Operating Temperature			-40		+105	°C

¹ See the Typical Connection Diagram section for a description of the reverse voltage on the ADPD2140W.

ABSOLUTE MAXIMUM RATINGS

Table 2.

Parameter	Rating
Voltage (Any Channel)	
Forward	0.1 V
Reverse	8 V
Power Dissipation	8 mW
Storage Temperature	125°C
Junction Temperature	110°C
Solder Reflow Temperature (<10 sec)	260°C
Electrostatic Discharge (ESD)	
Human Body Model (HBM)	2000 V
Charged Device Model (CDM)	1250 V

Stresses at or above those listed under Absolute Maximum Ratings may cause permanent damage to the product. This is a stress rating only; functional operation of the product at these or any other conditions above those indicated in the operational section of this specification is not implied. Operation beyond the maximum operating conditions for extended periods may affect product reliability.

THERMAL RESISTANCE

Thermal performance is directly linked to printed circuit board (PCB) design and operating environment. Careful attention to PCB thermal design is required.

θ_{JA} is the natural convection junction to ambient thermal resistance measured in a one cubic foot sealed enclosure. θ_{JC} is the junction to case thermal resistance.

Table 3. Thermal Resistance¹

Package Type	θ_{JA}	θ_{JC}	Unit
CP-8-17	64.70	8.80	°C/W

¹ Test condition: the thermal impedance simulated values are based on a JEDEC 2S2P thermal test board with four thermal vias. See JEDEC JESD-51.

SOLDERING PROFILE

Figure 2 and Table 4 provide details about the recommended soldering profile.

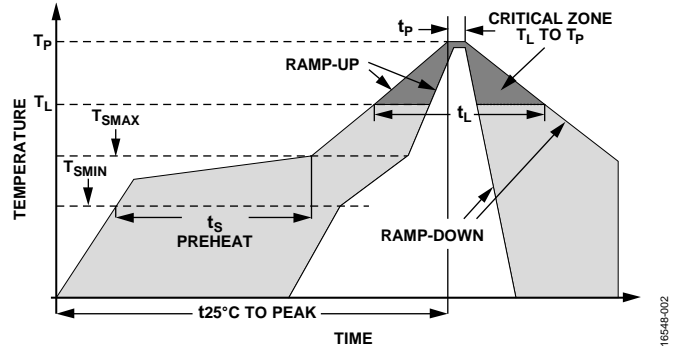

Figure 2. Recommended Soldering Profile

Table 4. Recommended Soldering Profile Limits¹

Profile Feature	Condition (Pb Free)
Average Ramp Rate (T_L to T_P)	2°C/sec maximum
Preheat	
Minimum Temperature (T_{SMIN})	150°C
Maximum Temperature (T_{SMAX})	200°C
Time (T_{SMIN} to T_{SMAX}) (t_s)	60 sec to 120 sec
T_{SMAX} to T_L Ramp-Up Rate	2°C/sec maximum
Liquidus Temperature (T_L)	217°C
Time Maintained Above T_L (t_L)	60 sec to 150 sec
Peak Temperature (T_P)	260°C + (0°C/-5°C)
Time Within 5°C of Actual Peak Temperature (t_p)	20 sec to 30 sec
Ramp Down Rate	3°C/sec maximum
Time from 25°C to Peak Temperature ($t_{25°C TO PEAK}$)	8 minutes maximum

¹ Based on JEDEC Standard J-STD-020D.1.

ESD CAUTION



ESD (electrostatic discharge) sensitive device. Charged devices and circuit boards can discharge without detection. Although this product features patented or proprietary protection circuitry, damage may occur on devices subjected to high energy ESD. Therefore, proper ESD precautions should be taken to avoid performance degradation or loss of functionality.

PIN CONFIGURATION AND FUNCTION DESCRIPTIONS

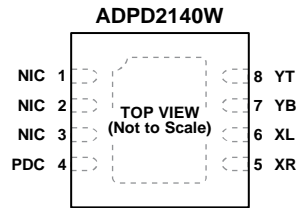

NOTES
 1. NIC = NOT INTERNALLY CONNECTED.
 2. EXPOSED PAD. ALWAYS CONNECT THE EXPOSED PAD TO PDC. DO NOT CONNECT THE EXPOSED PAD TO GROUND UNLESS PDC IS ALSO CONNECTED TO GROUND.

18548-003

Figure 3. Pin Configuration

Table 5. Pin Function Descriptions

Pin No.	Mnemonic	Type	Description
1	NIC	Not internally connected	Not Internally Connected. Leave this pin floating.
2	NIC	Not internally connected	Not Internally Connected. Leave this pin floating.
3	NIC	Not internally connected	Not Internally Connected. Leave this pin floating.
4	PDC	Analog input	Photodiode Common Cathode.
5	XR	Analog output	Photodiode Anode for X-Axis, Right Channel.
6	XL	Analog output	Photodiode Anode for X-Axis, Left Channel.
7	YB	Analog output	Photodiode Anode for Y-Axis, Bottom Channel.
8	YT	Analog output	Photodiode Anode for Y-Axis, Top Channel.
	EPAD	Not applicable	Exposed Pad. Always connect the exposed pad to PDC. Do not connect the exposed pad to ground unless PDC is also connected to ground.

TYPICAL PERFORMANCE CHARACTERISTICS

All performance characteristics listed for the sum of all four photodiode channels, unless otherwise noted.

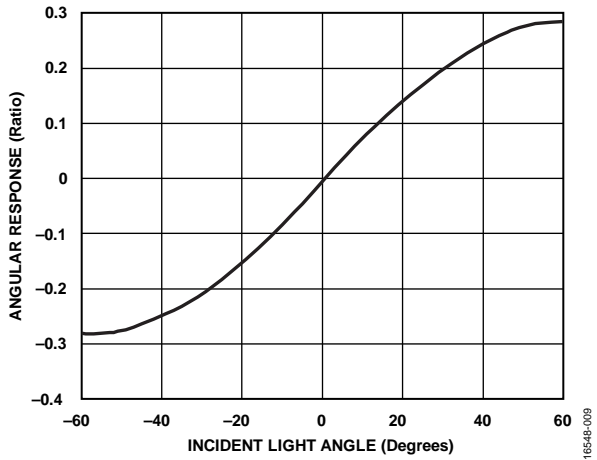

Figure 4. Angular Response vs. Incident Light Angle, Off Axis Angle Held at 0°

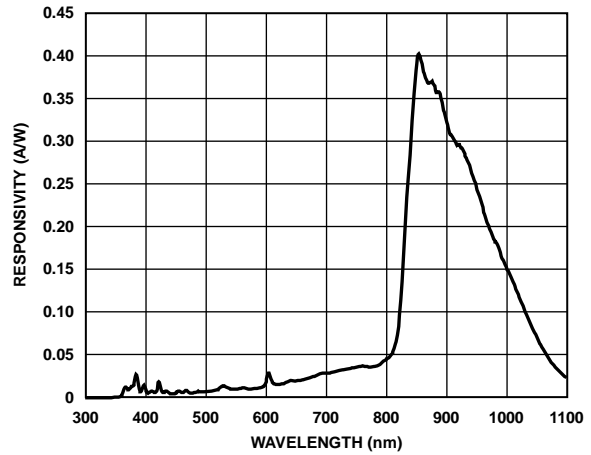

Figure 7. Responsivity vs. Wavelength (Angle = 0°)

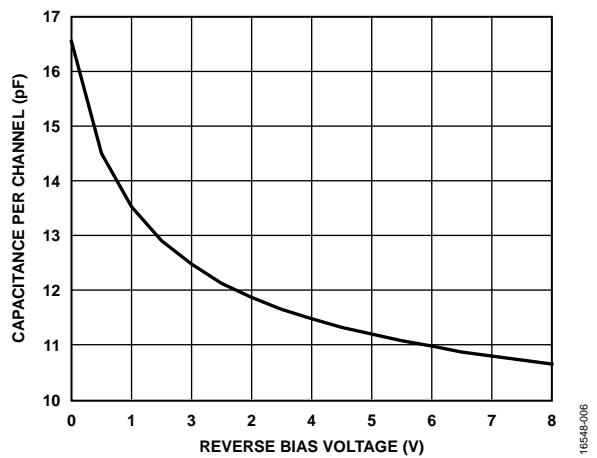

Figure 5. Capacitance per Channel vs. Reverse Bias Voltage

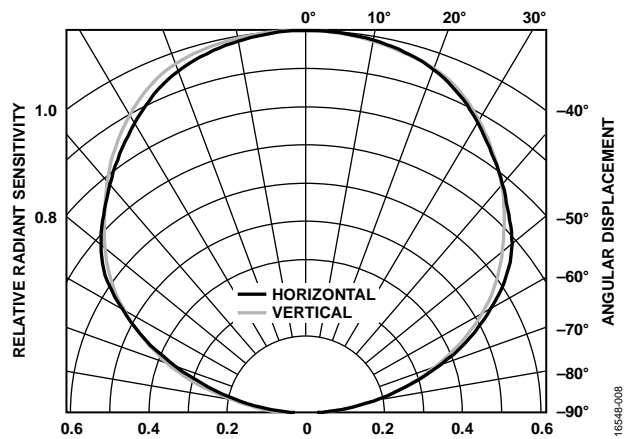

Figure 8. Relative Radiant Sensitivity vs. Angular Displacement

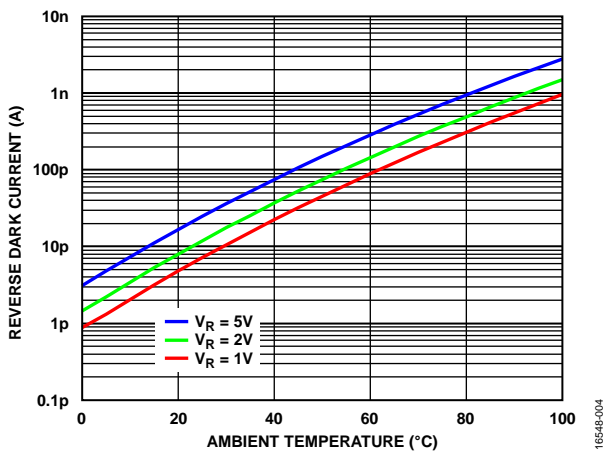

Figure 6. Reverse Dark Current vs. Ambient Temperature over Reverse Voltage (V_R)

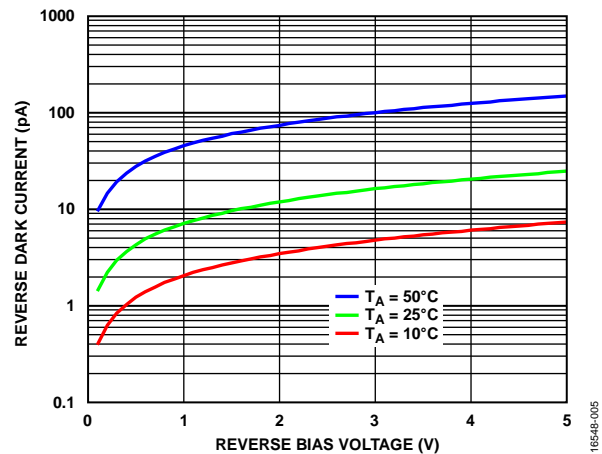

Figure 9. Reverse Dark Current vs. Reverse Bias Voltage over Temperature

THEORY OF OPERATION

ANGULAR RESPONSE

The ADPD2140W consists of arrays of silicon p type, intrinsic, n type (PIN) photodiodes that provide a linear measurement of incident infrared light angle. There are four separate channels on the ADPD2140W, each corresponding to one photodiode.

The ADPD2140W enables a 2-axis light angle measurement, in both the x and y direction. To calculate angles in the x and y direction with respect to the sensor use the four photodiode channels (x_L , x_R , y_T , and y_B) and the following equations:

$$x = (x_L - x_R) / (x_L + x_R) \tag{1}$$

$$y = (y_T - y_B) / (y_T + y_B) \tag{2}$$

The resulting quantities (x and y) are ratios related to angles through a constant term. These quantities can be seen as a function of incident light angle in Figure 4. The directionality when using Equation 1 and Equation 2 is shown in Figure 10, which indicates positive angles in the x and y directions.

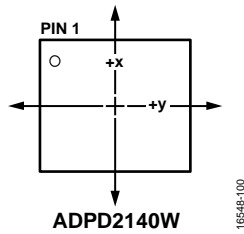

Figure 10. Directionality Response As Viewed from Top

The ADPD2140W is typically used in conjunction with an LED or laser emitter operating at a near infrared wavelength. The ADPD2140W provides light angle measurement without the need for an external lens. An external lens is neither required nor recommended for operation.

An integrated visible light blocking optical filter on the ADPD2140W provides built in rejection of unwanted visible ambient light signals, such as sunlight and indoor lighting. Figure 7 shows the responsivity of the ADPD2140W with its integrated optical filter.

The low diode capacitance and low dark current of the ADPD2140W allows optimal integration with the ADPD1080 photometric front end. This complete solution offers additional ambient light rejection, low power operation, and analog-to-digital conversion of the ADPD2140W analog signals.

TYPICAL CONNECTION DIAGRAM

Figure 11 shows the ADPD2140W connections with the ADPD1080 photometric front end. With up to eight photodiode input channels, the ADPD1080 is a preferred choice for the analog front end for interfacing with the ADPD2140W. In this configuration, the ADPD2140W and ADPD1080 solution can operate using synchronous LED pulses to detect the angle of light reflected from objects or be used in ambient measurement mode to provide a measure of the incident angle of an ambient or other unsynchronized light source.

The bias voltage, V_B , applied across any of the anodes (YT, YB, XL, or XR) and the cathode (PDC) is denoted as positive from an anode to the cathode. The reverse bias voltage, V_R , is denoted as positive from the cathode to an anode. For reference, the optimal choice of reverse bias for typical operation with the ADPD2140W is $V_R = 0.25$ V.

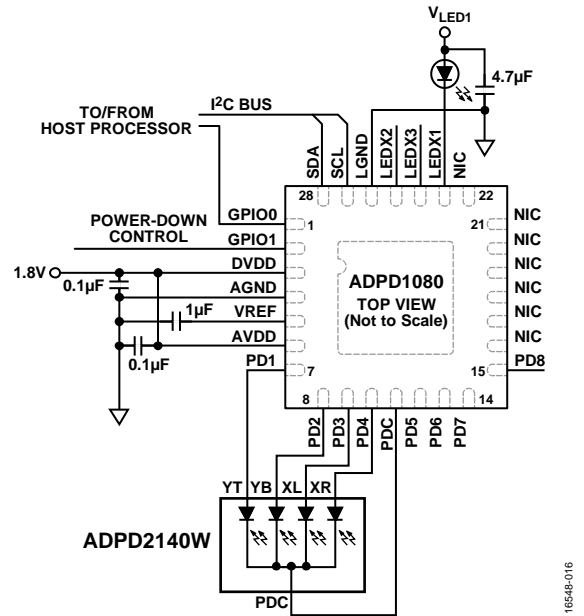

Figure 11. Typical Connection Diagram for the ADPD2140W and the ADPD1080

APPLICATIONS INFORMATION

GESTURE RECOGNITION

The unique angular response of the ADPD2140W coupled with the high performance ambient light rejection of the ADPD1080 enables a robust and effective implementation of gesture recognition. The following algorithm demonstrates recognition of up, down, left, right, and click hand gestures based on data from the four channels of the ADPD2140W:

1. Prior to operation of the ADPD2140W and the ADPD1080 for gesture recognition, calibrate the ADPD1080 clocks. See the ADPD1080 data sheet for more information on how to calibrate the 32 kHz and 32 MHz clocks.
2. Set the ADPD1080 mode of operation to sample mode by writing 0x2 to Register 0x10, Bits [1:0].
3. Collect the data measured by the device. See the ADPD1080 data sheet for instructions on how to read data from registers using the first in, first out (FIFO) and interrupts. Data is available directly from data registers or from the 128-byte FIFO in Register 0x60, Bits [15:0].
4. The data in the four output channels of the ADPD1080 calculates the angle of incident light. After the x_L , x_R , y_T , and y_B data are collected, calculate the angles and intensity with the following equations:
 - Horizontal angle: $x = (x_L - x_R)/(x_L + x_R)$
 - Vertical angle: $y = (y_T - y_B)/(y_T + y_B)$
 - Intensity: $L = x_L + x_R + y_T + y_B$
5. Prior to gesture event detection, offsets of the ADPD1080 must be digitally subtracted from each channel. These offsets are not due to photodiode dark current and are set by the ADPD1080 on-chip analog-to-digital converter (ADC). Register 0x18, Register 0x19, Register 0x1A, and Register 0x1B contain the ADC offsets for Timeslot A, while Register 0x1A, Register 0x1B, Register 0x1E, and Register 0x1F contain the ADC offsets for Timeslot B. The nominal value for all offsets is 0x2000. To modify these offsets, measure the 16-bit output of each channel, in ADC codes, and add it to the existing 16-bit number in the ADC offset register, SLOTx_CHx_OFFSET (nominally 0x2000). Then, write to the ADC offset register with this result. When the offsets are correctly subtracted, the intensity reading L is close to zero codes with no objects in the sensor field of view.
6. The start of a gesture event can be defined as occurring when intensity data crosses a preset threshold. Nominally, this threshold must be set to 1000 codes. However, the threshold can be adjusted to suit the application.
7. The end of a gesture event can then be defined as the number of samples after which the intensity drops back below the preset threshold, past a certain minimum number of samples (nominally five samples).

8. Use the start and stop points of the gesture event to determine whether the gesture was up, right, left, down, or a click. For more detail on this process, see the following pseudocode:

```

event = False
intensityThreshold = 1000 (should be
adjustable by the user)
clickThreshold = 0.07 (should be adjustable
by the user)

if event = True:
    i += 1
    if i >= 5 and L < intensityThreshold:
        event = False
        gestureStopX = x
gestureStopY = y
m = (gestureStartY -
gestureStopY)/(gestureStartX - gestureStopX
+ 1e-6)
d = sqrt((gestureStartX - gestureStopX)^2 +
(gestureStartY - gestureStopY)^2)
if d < clickThreshold:
    gesture = 'CLICK'
else:
    if abs(m) > 1:
        if gestureStartY >
gestureStopY:
            gesture = 'UP'
        else:
            gesture = 'DOWN'
    elif abs(m) < 1:
        if gestureStartX >
gestureStopX:
            gesture = 'LEFT'
        else:
            gesture = 'RIGHT'
    else:
        if L > intensityThreshold:
            i = 0
            event = True
            gestureStartX = x
gestureStartY = y
  
```

OUTLINE DIMENSIONS

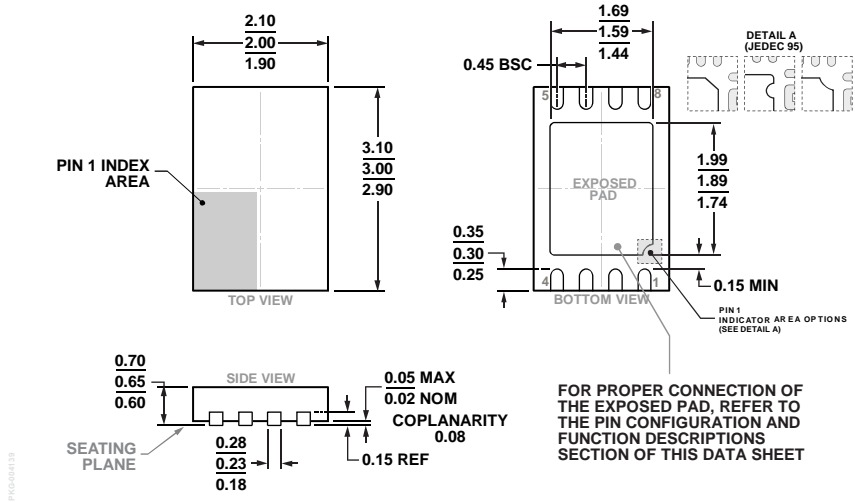

Figure 12. 8-Lead Lead Frame Chip Scale Package [LFCSP]
 2 mm x 3 mm Body and 0.65 mm Package Height
 (CP-8-17)
 Dimensions shown in millimeters

Table 6. Marking Code Format, Line 1 (See Figure 13)

Description	Position	Font Type	Height (mm)	Width (mm)	Space (mm)	Maximum Width (mm)	Maximum Characters
Binary	Not applicable	Bar font (Symbol 1/Symbol 2)	0.075	0.05	0.08	1.61	13 (6 + 7)

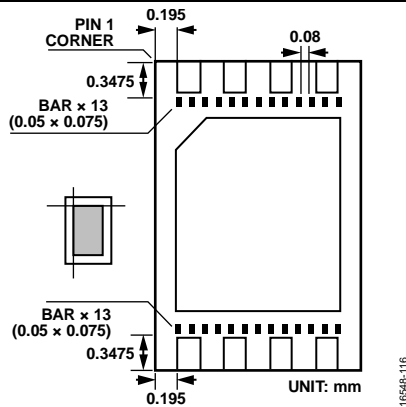

Figure 13. ADPD2140W Marking Codes As Viewed from Bottom

ORDERING GUIDE

Model ^{1,2}	Temperature Range	Package Description	Package Option
ADPD2140WBPCZN-R7	−40°C to +105°C	8-Lead Lead Frame Chip Scale Package [LFCSP]	CP-8-17
ADPD2140WBPCZN-RL	−40°C to +105°C	8-Lead Lead Frame Chip Scale Package [LFCSP]	CP-8-17
EVAL-ADPD2140Z		ADPD2140W Evaluation Board	

¹ Z = RoHS Complaint Part.

² W = Qualified for Automotive Applications.

AUTOMOTIVE PRODUCTS

The ADPD2140W models are available with controlled manufacturing to support the quality and reliability requirements of automotive applications. Note that these automotive models may have specifications that differ from the commercial models; therefore, designers should review the Specifications section of this data sheet carefully. Only the automotive grade products shown are available for use in automotive applications. Contact your local Analog Devices account representative for specific product ordering information and to obtain the specific Automotive Reliability reports for these models.