

## FEATURES

### Downconverter

#### Conversion loss

10 dB typical for 22 GHz to 29 GHz

11 dB typical for 29 GHz to 38 GHz

#### LO to RF isolation

34 dB typical for 22 GHz to 29 GHz

38 dB typical for 29 GHz to 38 GHz

#### LO to IF isolation

29 dB typical for 22 GHz to 29 GHz

31 dB typical for 29 GHz to 38 GHz

#### RF to IF isolation

24 dB typical for 22 GHz to 29 GHz

39 dB typical for 29 GHz to 38 GHz

#### Input IP3

20 dBm typical for 22 GHz to 29 GHz

19.5 dBm typical for 29 GHz to 38 GHz

IF bandwidth: dc to 18 GHz

Passive, no dc bias required

## APPLICATIONS

Point to point radios

Point to multipoint radios and very small aperture terminal  
(VSAT) radios

Test equipment and sensors

Military end use

## GENERAL DESCRIPTION

The HMC560ALM3 chip is a general-purpose, double balanced mixer that can be used as an upconverter or downconverter from 22 GHz to 38 GHz in a small chip area. This mixer requires no external component or matching circuitry.

## FUNCTIONAL BLOCK DIAGRAM

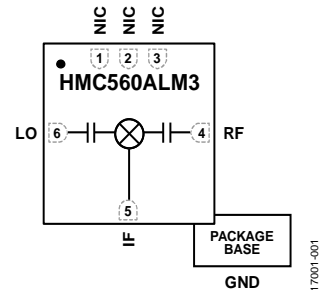

Figure 1.

The HMC560ALM3 provides excellent local oscillator (LO) to radio frequency (RF) and LO to intermediate frequency (IF) suppression due to optimized balun structures. The mixer operates with LO drive levels above 9 dBm.

## TABLE OF CONTENTS

Features .....	1	Downconverter Performance .....	6
Applications .....	1	Upconverter Performance .....	12
Functional Block Diagram .....	1	Isolation and Return Loss .....	16
General Description .....	1	IF Bandwidth—Downconverter .....	18
Revision History .....	2	Spurious and Harmonics Performance .....	19
Specifications .....	3	Theory of Operation .....	20
Electrical Specifications .....	3	Applications Information .....	21
Absolute Maximum Ratings .....	4	Typical Application Circuit .....	21
Thermal Resistance .....	4	Evaluation PCB Information .....	21
ESD Caution .....	4	Outline Dimensions .....	22
Pin Configuration and Function Descriptions .....	5	Ordering Guide .....	22
Interface Schematics .....	5		
Typical Performance Characteristics .....	6		

## REVISION HISTORY

6/2019—Revision 0: Initial Version

## SPECIFICATIONS

### ELECTRICAL SPECIFICATIONS

T<sub>A</sub> = 25°C, IF = 1 GHz, LO drive level = 13 dBm, RF frequency range = 22 GHz to 29 GHz, all measurements performed as a downconverter with the upper sideband selected, unless otherwise noted.

Table 1.

Parameter	Symbol	Min	Typ	Max	Unit
FREQUENCY RANGE					
Radio Frequency	RF	22		29	GHz
Local Oscillator	LO	22		29	GHz
Intermediate Frequency	IF	dc		18	GHz
CONVERSION LOSS			10	14	dB
NOISE FIGURE			10.5		dB
ISOLATION					
LO to RF			34		dB
LO to IF		16	29		dB
RF to IF		8	24		dB
INPUT THIRD-ORDER INTERCEPT	IP3	9	20		dBm
INPUT SECOND-ORDER INTERCEPT	IP2		38		dBm
INPUT POWER					
1 dB Compression	P1dB		9		dBm
UPCONVERTER PERFORMANCE					
Conversion Loss			10		dB
IP3			13.5		dBm
RETURN LOSS					
RF			7		dB
LO			8		dB

T<sub>A</sub> = 25°C, IF = 1 GHz, LO drive level = 13 dBm, RF frequency range = 29 GHz to 38 GHz, all measurements performed as a downconverter with the upper sideband selected, unless otherwise noted.

Table 2.

Parameter	Symbol	Min	Typ	Max	Unit
FREQUENCY RANGE					
Radio Frequency	RF	29		38	GHz
Local Oscillator	LO	29		38	GHz
Intermediate Frequency	IF	dc		18	GHz
CONVERSION LOSS			11	15	dB
NOISE FIGURE			11.5		dB
ISOLATION					
LO to RF			38		dB
LO to IF		10	31		dB
RF to IF		11	39		dB
INPUT THIRD-ORDER INTERCEPT	IP3	9	19.5		dBm
INPUT SECOND-ORDER INTERCEPT	IP2		38		dBm
INPUT POWER					
1 dB Compression	P1dB		11.5		dBm
UPCONVERTER PERFORMANCE					
Conversion Loss			9		dB
IP3			16.5		dBm
RETURN LOSS					
RF			14		dB
LO			7		dB

## ABSOLUTE MAXIMUM RATINGS

Table 3.

Parameter	Rating
RF Input Power	25 dBm
LO Input Power	23 dBm
IF Input Power	25 dBm
IF Source and Sink Current	2 mA
Channel Temperature	150°C/W
Maximum Peak Reflow Temperature (MSL3)	260°C
Continuous Power Dissipation, $P_{Diss}$ ( $T_A = 85^\circ\text{C}$ , Derate 5.3 mW/ $^\circ\text{C}$ Above 85°C)	344 mW
Storage Temperature Range	-65°C to +150°C
Operating Temperature Range	-40°C to +85°C
Electrostatic Discharge (ESD) Sensitivity	
Human Body Model (HBM)	500 V
Field Induced Charged Device Model (FICDM)	1250 V

Stresses at or above those listed under Absolute Maximum Ratings may cause permanent damage to the product. This is a stress rating only; functional operation of the product at these or any other conditions above those indicated in the operational section of this specification is not implied. Operation beyond the maximum operating conditions for extended periods may affect product reliability.

## THERMAL RESISTANCE

Thermal performance is directly linked to printed circuit board (PCB) design and operating environment. Careful attention to PCB thermal design is required.  $\theta_{JC}$  is the junction to case thermal resistance, from the channel to the bottom of the die.

Table 4. Thermal Resistance

Package Type	$\theta_{JA}$	$\theta_{JC}$	Unit
CE-6-3	67.6	188	$^\circ\text{C}/\text{W}$

## ESD CAUTION



**ESD (electrostatic discharge) sensitive device.** Charged devices and circuit boards can discharge without detection. Although this product features patented or proprietary protection circuitry, damage may occur on devices subjected to high energy ESD. Therefore, proper ESD precautions should be taken to avoid performance degradation or loss of functionality.

# PIN CONFIGURATION AND FUNCTION DESCRIPTIONS

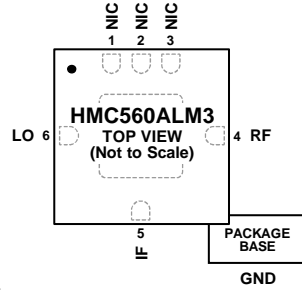

- NOTES**
1. NIC = NOT INTERNALLY CONNECTED. THESE PINS CAN BE CONNECTED TO RF/DC GROUND WITHOUT AFFECTING PERFORMANCE.
  2. EXPOSED PAD. THE EXPOSED PAD MUST BE CONNECTED TO RF AND DC GROUND.

17701-002

Figure 2.

Table 5. Pin Function Descriptions

Pin No.	Mnemonic	Description
1, 2, 3	NIC	Not Internally Connected. No connection is required. These pins can be connected to RF/dc ground without affecting performance.
4	RF	Radio Frequency Port. This pin is ac-coupled and matched to 50 Ω. See Figure 6 for the RF interface schematic.
5	IF	Intermediate Frequency Port. This pin is dc-coupled. For applications not requiring operation to dc, dc block this port externally using a series capacitor of a value chosen to pass the necessary IF frequency range. For operation to dc, this pin must not source or sink more than 2 mA of current or die malfunction and possible die failure may result. See Figure 5 for the IF interface schematic.
6	LO	Local Oscillator Port. This pin is ac-coupled and matched to 50 Ω. See Figure 4 for the LO interface schematic.
Exposed Pad	GND	Exposed Pad. The exposed pad must be connected to RF and dc ground. See Figure 3 for the GND interface schematic.

## INTERFACE SCHEMATICS



Figure 3. GND Interface Schematic

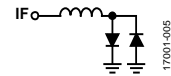

Figure 5. IF Interface Schematic

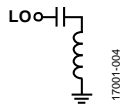

Figure 4. LO Interface Schematic

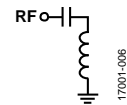

Figure 6. RF Interface Schematic

# TYPICAL PERFORMANCE CHARACTERISTICS

## DOWNCONVERTER PERFORMANCE

### Downconverter Performance at IF = 1 GHz, Upper Sideband

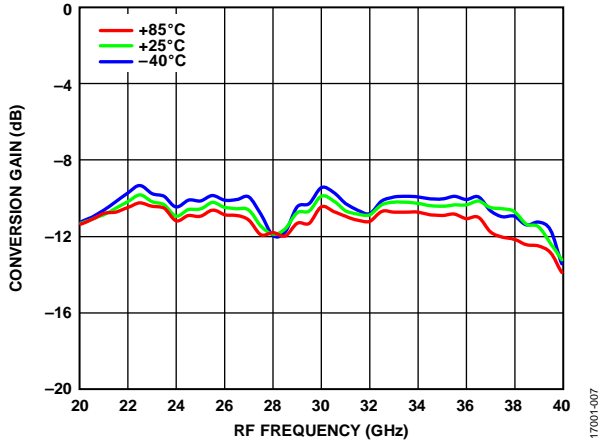

Figure 7. Conversion Gain vs. RF Frequency at Various Temperatures, LO = 13 dBm

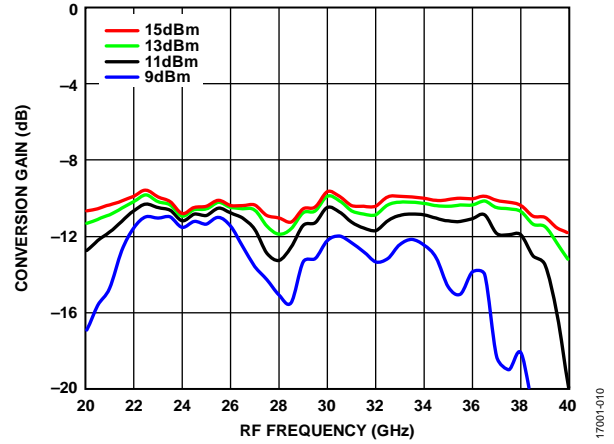

Figure 10. Conversion Gain vs. RF Frequency at Various LO Power Levels,  $T_A = 25^\circ\text{C}$

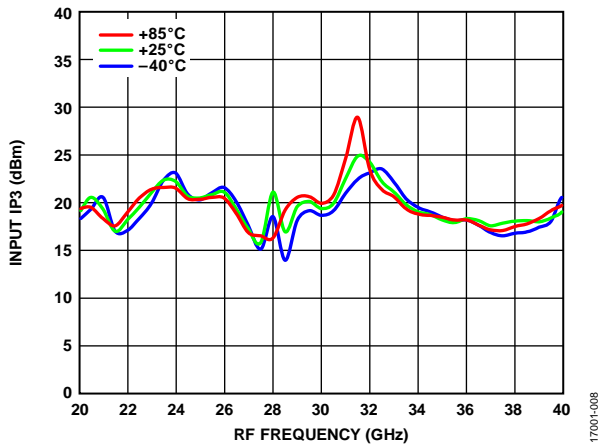

Figure 8. Input IP3 vs. RF Frequency at Various Temperatures, LO = 13 dBm

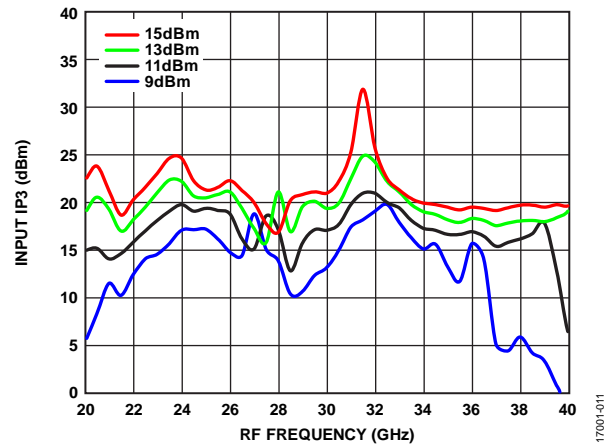

Figure 11. Input IP3 vs. RF Frequency at Various LO Power Levels,  $T_A = 25^\circ\text{C}$

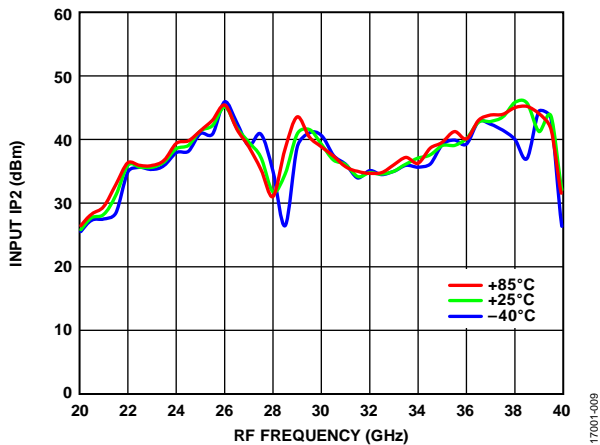

Figure 9. Input IP2 vs. RF Frequency at Various Temperatures, LO = 13 dBm

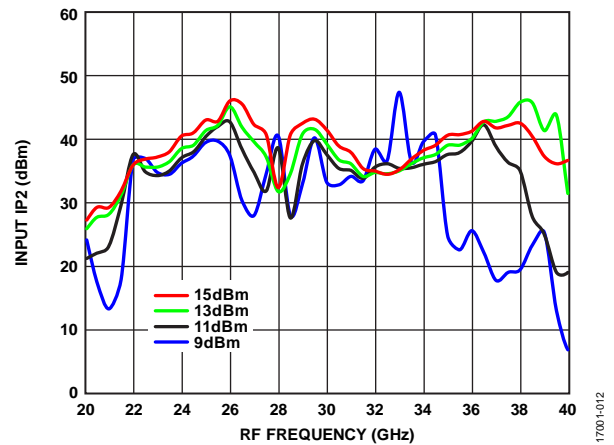

Figure 12. Input IP2 vs. RF Frequency at Various LO Power Levels,  $T_A = 25^\circ\text{C}$

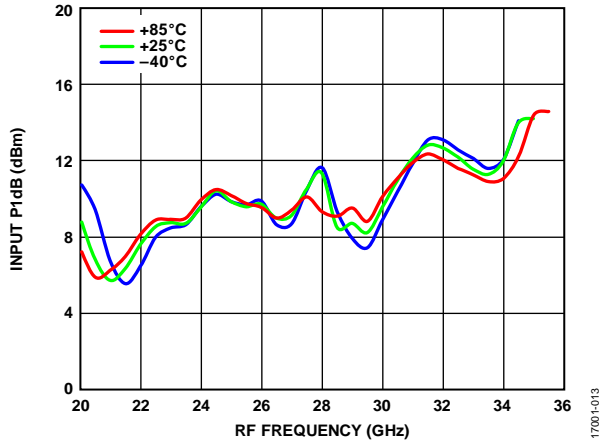

Figure 13. Input P1dB vs. RF Frequency at Various Temperatures, LO = 13 dBm

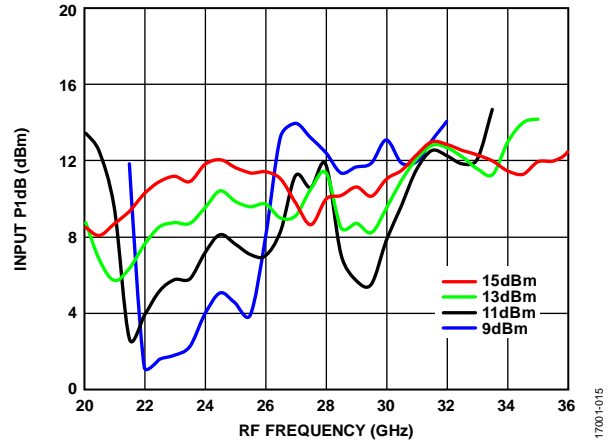

Figure 15. Input P1dB vs. RF Frequency at Various LO Power Levels, TA = 25°C

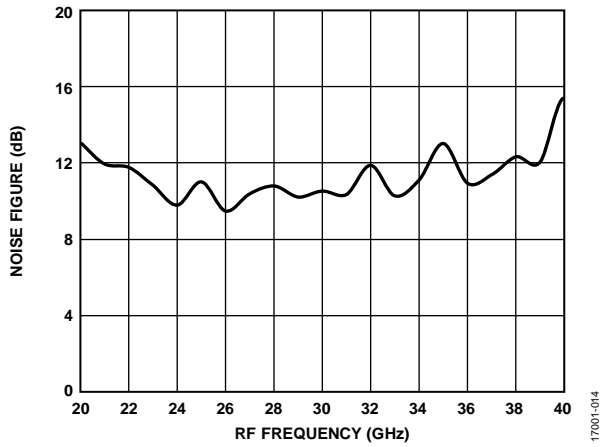

Figure 14. Noise Figure vs. RF Frequency at TA = 25°C, LO = 13 dBm

17001-013

17001-015

17001-014

**Downconverter Performance at IF = 10 GHz, Upper Sideband**

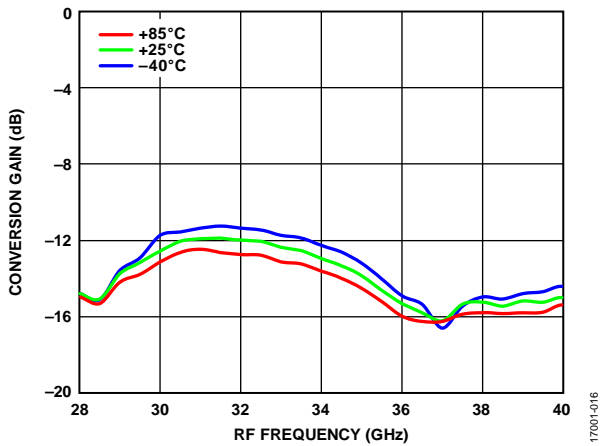

Figure 16. Conversion Gain vs. RF Frequency at Various Temperatures, LO = 13 dBm

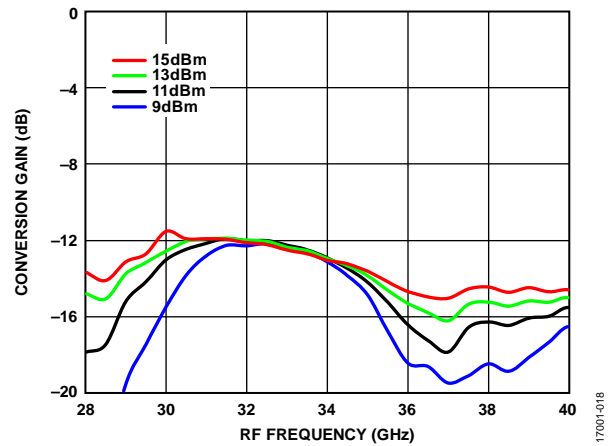

Figure 18. Conversion Gain vs. RF Frequency at Various LO Power Levels,  $T_A = 25^\circ\text{C}$

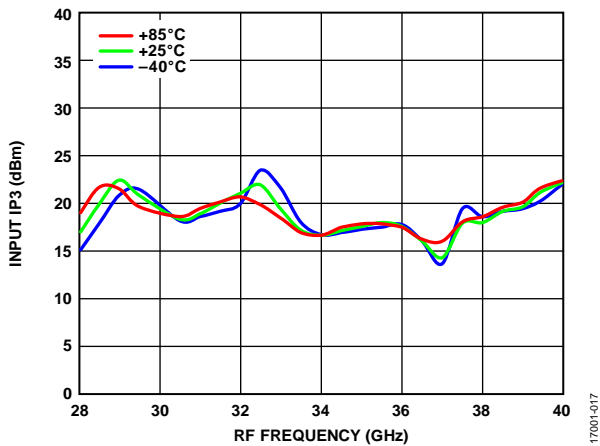

Figure 17. Input IP3 vs. RF Frequency at Various Temperatures, LO = 13 dBm

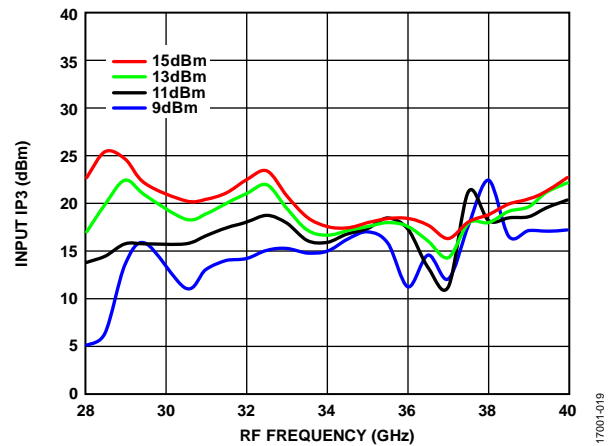

Figure 19. Input IP3 vs. RF Frequency at Various LO Power Levels,  $T_A = 25^\circ\text{C}$



**Downconverter Performance at IF = 1 GHz, Lower Sideband**

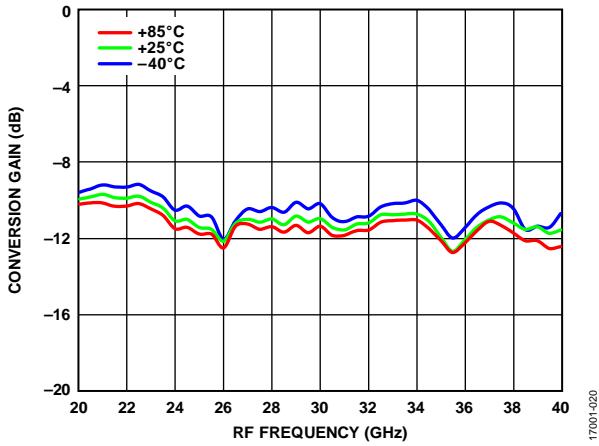

Figure 20. Conversion Gain vs. RF Frequency at Various Temperatures, LO = 13 dBm

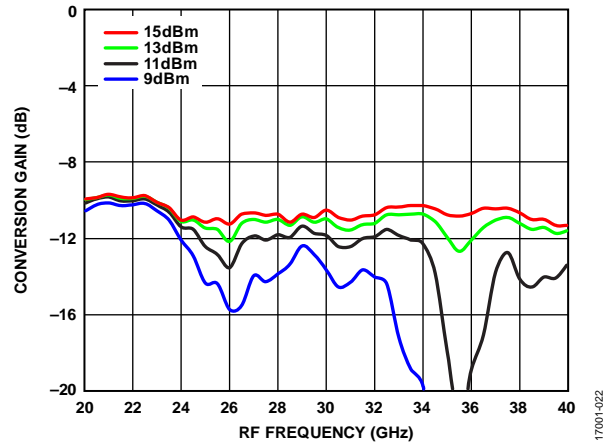

Figure 22. Conversion Gain vs. RF Frequency at Various LO Power Levels,  $T_A = 25^\circ\text{C}$

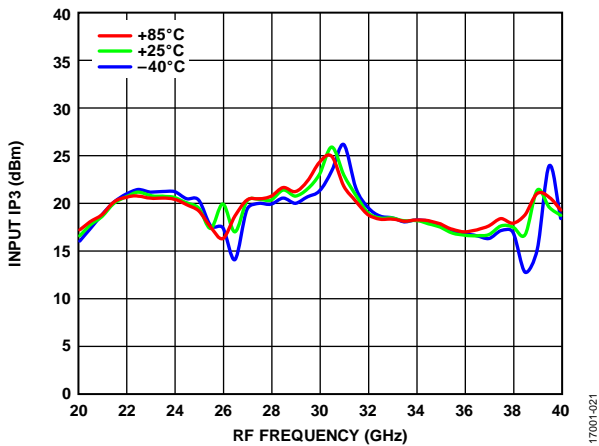

Figure 21. Input IP3 vs. RF Frequency at Various Temperatures, LO = 13 dBm

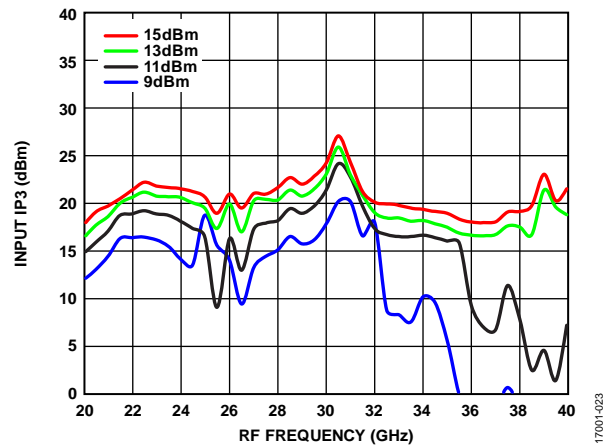

Figure 23. Input IP3 vs. RF Frequency at Various LO Power Levels,  $T_A = 25^\circ\text{C}$

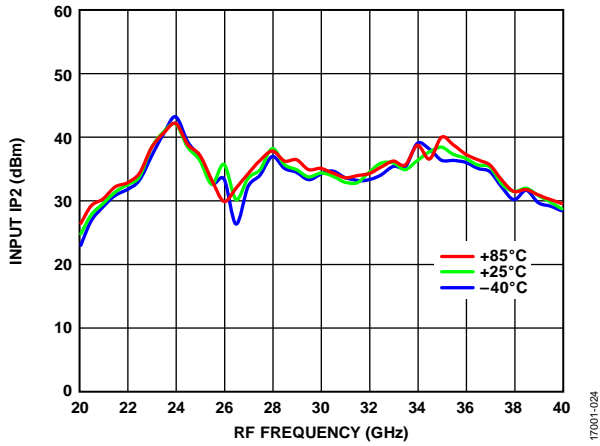

Figure 24. Input IP2 vs. RF Frequency at Various Temperatures,  $T_A = 25^\circ\text{C}$

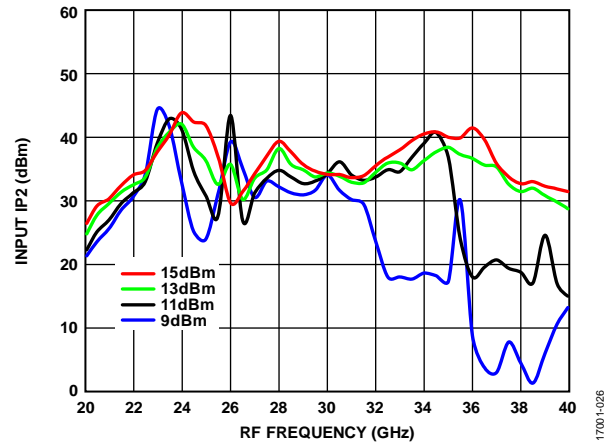

Figure 26. Input IP2 vs. RF Frequency at Various LO Power Levels,  $T_A = 25^\circ\text{C}$

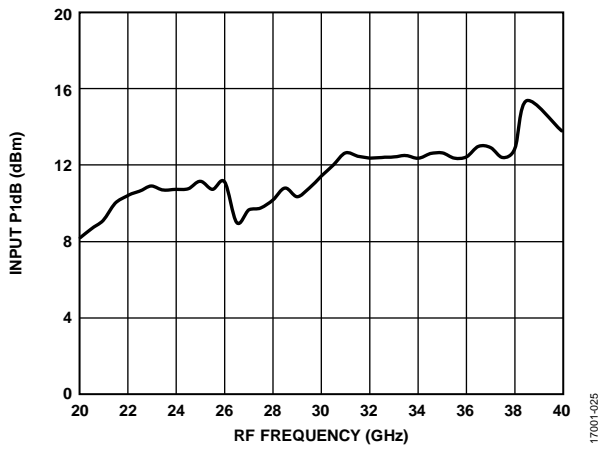

Figure 25. Input P1dB vs. RF Frequency at Various LO Power Levels,  $T_A = 25^\circ\text{C}$

**Downconverter Performance at IF = 10 GHz, Lower Sideband**

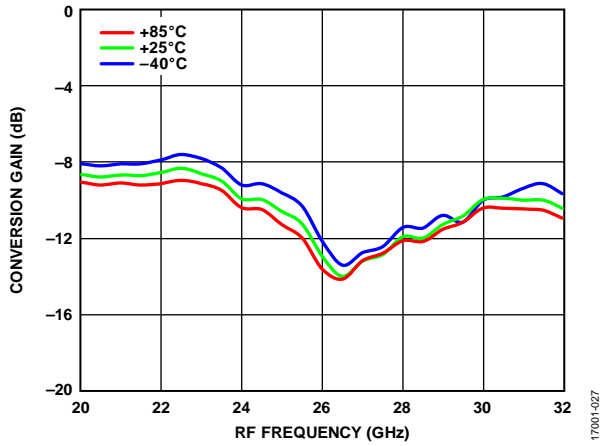

Figure 27. Conversion Gain vs. RF Frequency at Various Temperatures, LO = 13 dBm

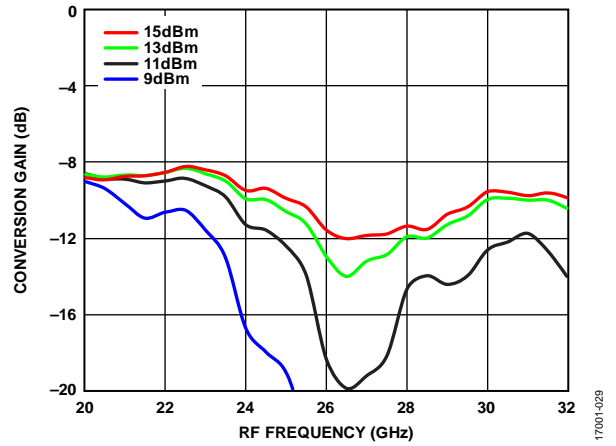

Figure 29. Conversion Gain vs. RF Frequency at Various LO Power Levels,  $T_A = 25^\circ\text{C}$

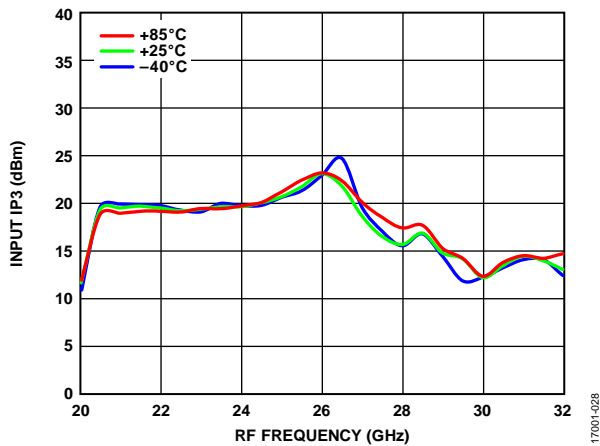

Figure 28. Input IP3 vs. RF Frequency at Various Temperatures, LO = 13 dBm

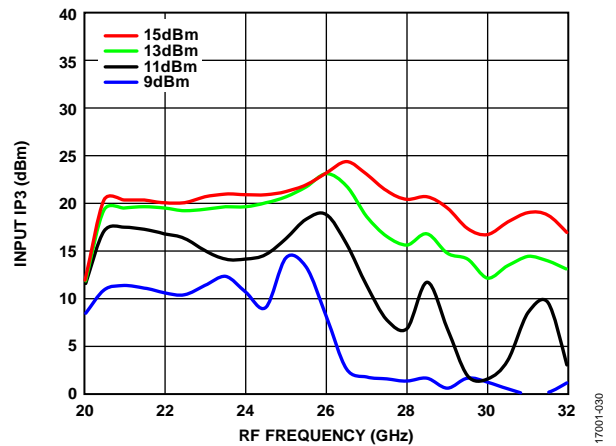

Figure 30. Input IP3 vs. RF Frequency at Various LO Power Levels,  $T_A = 25^\circ\text{C}$

**UPCONVERTER PERFORMANCE**

**Upconverter Performance at IF = 1 GHz, Upper Sideband**

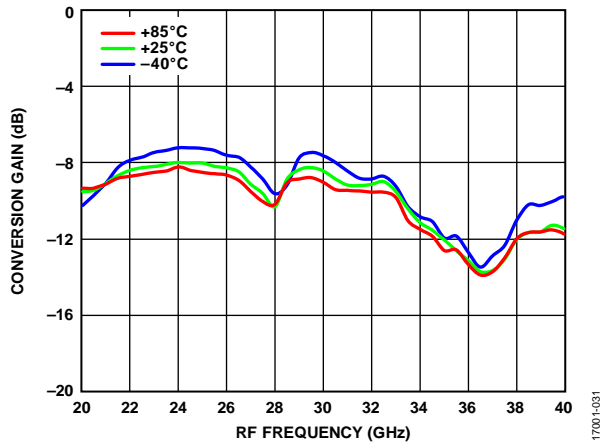

Figure 31. Conversion Gain vs. RF Frequency at Various Temperatures, LO = 13 dBm

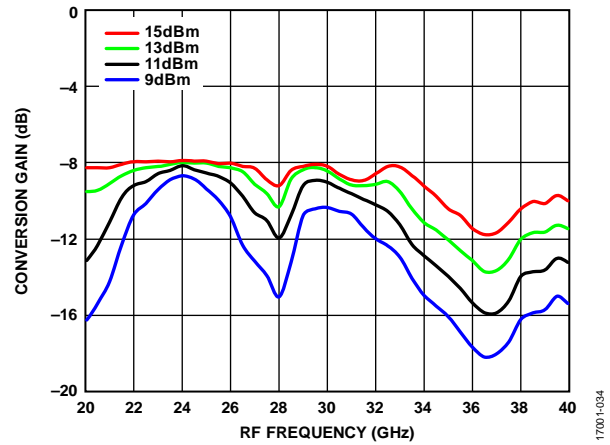

Figure 34. Conversion Gain vs. RF Frequency at Various LO Power Levels, TA = 25°C

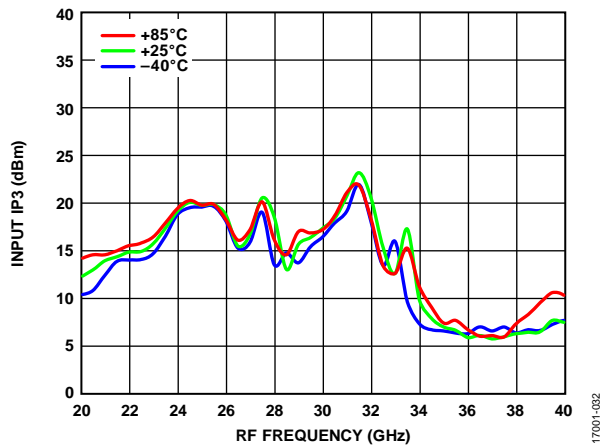

Figure 32. Input IP3 vs. RF Frequency at Various Temperatures, LO = 13 dBm

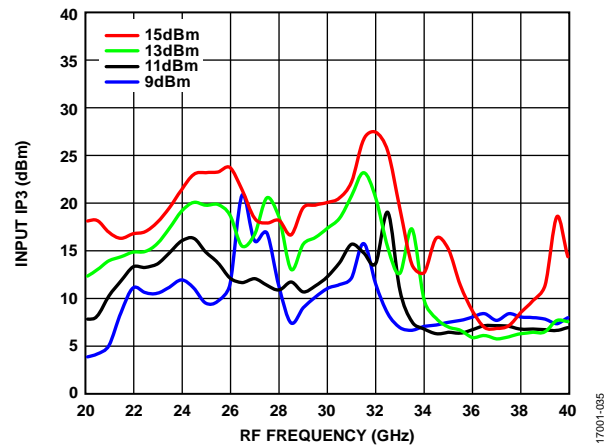

Figure 35. Input IP3 vs. RF Frequency at Various LO Power Levels, TA = 25°C

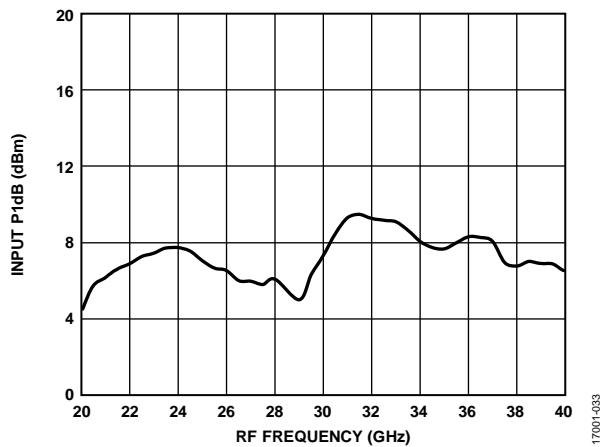

Figure 33. Input P1dB vs. RF Frequency at Various Temperatures, LO = 13 dBm

17001-031

17001-034

17001-032

17001-035

17001-033

**Upconverter Performance at IF = 10 GHz, Upper Sideband**

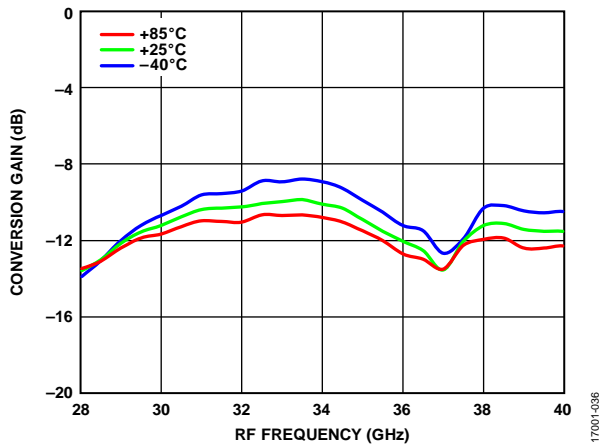

Figure 36. Conversion Gain vs. RF Frequency at Various Temperatures, LO = 13 dBm

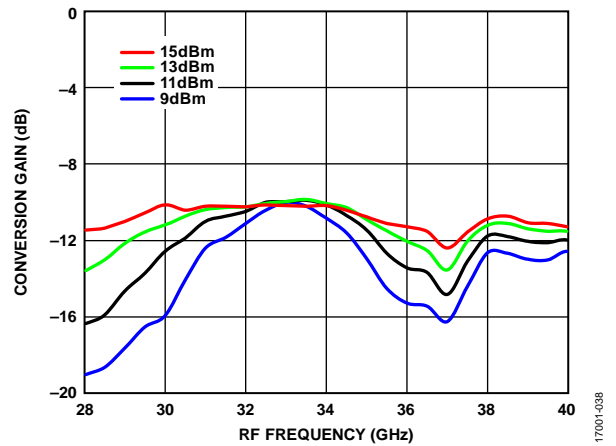

Figure 38. Conversion Gain vs. RF Frequency at Various LO Power Levels,  $T_A = 25^\circ\text{C}$

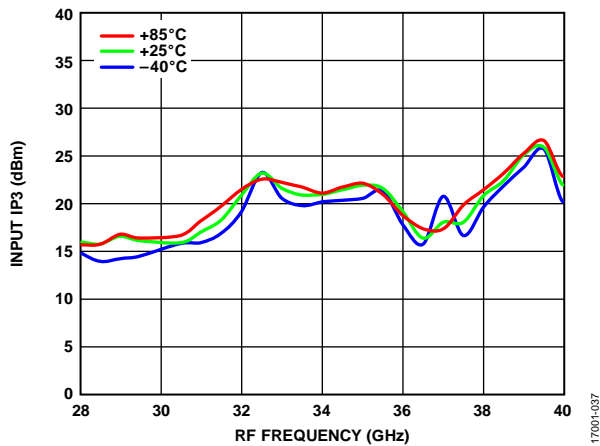

Figure 37. Input IP3 vs. RF Frequency at Various Temperatures, LO = 13 dBm

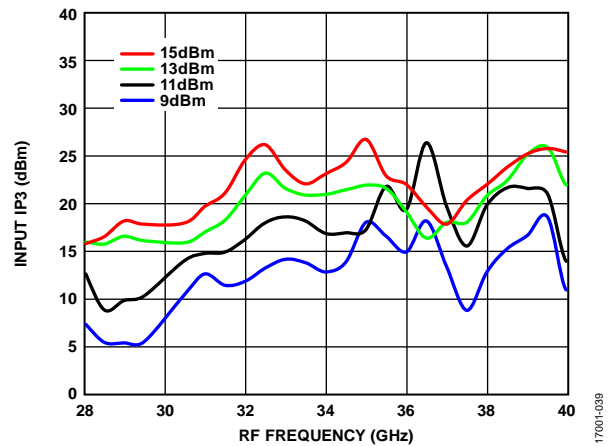

Figure 39. Input IP3 vs. RF Frequency at Various LO Power Levels,  $T_A = 25^\circ\text{C}$

Upconverter Performance at IF = 1 GHz, Lower Sideband

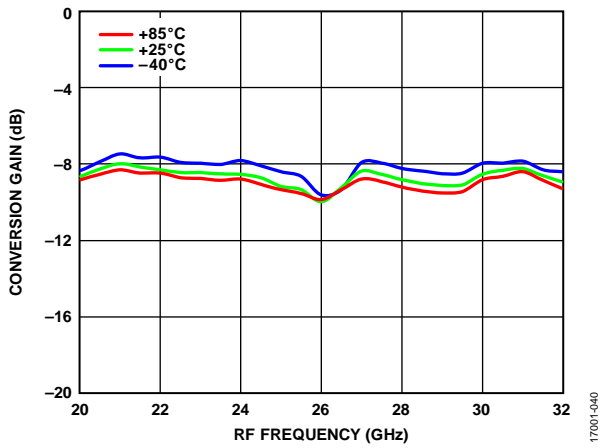

Figure 40. Conversion Gain vs. RF Frequency at Various Temperatures  
LO = 13 dBm

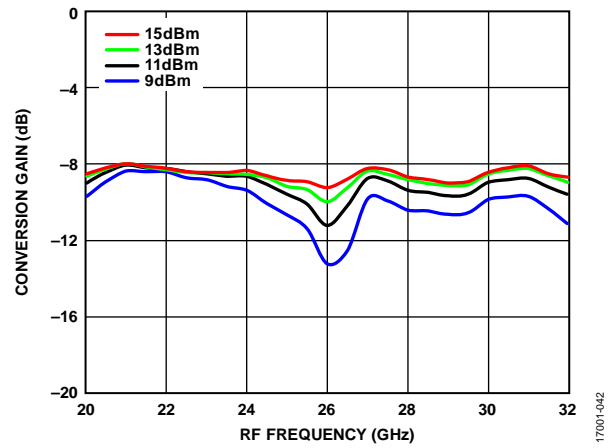

Figure 42. Conversion Gain vs. RF Frequency at Various LO Power Levels,  
 $T_A = 25^\circ\text{C}$

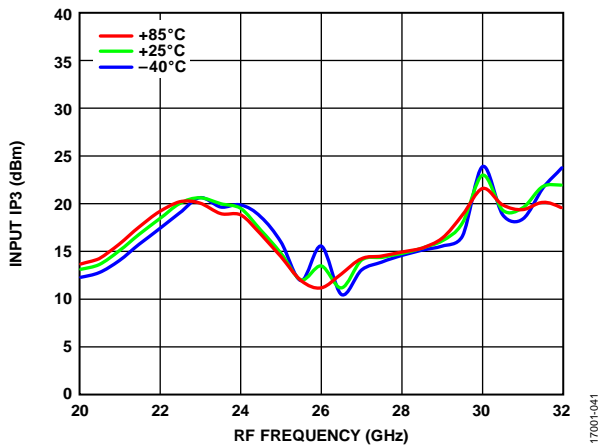

Figure 41. Input IP3 vs. RF Frequency at Various Temperatures,  
LO = 13 dBm

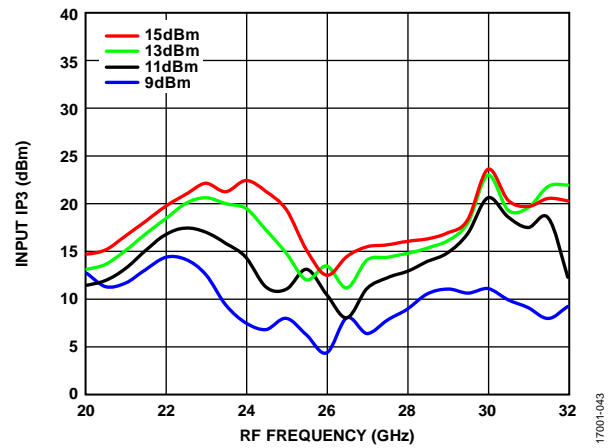

Figure 43. Input IP3 vs. RF Frequency at Various LO Power Levels,  
 $T_A = 25^\circ\text{C}$

**Upconverter Performance at IF = 10 GHz, Lower Sideband**

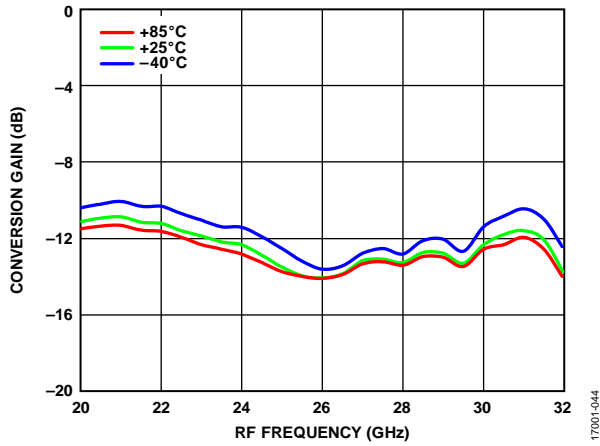

Figure 44. Conversion Gain vs. RF Frequency at Various Temperatures, LO = 13 dBm

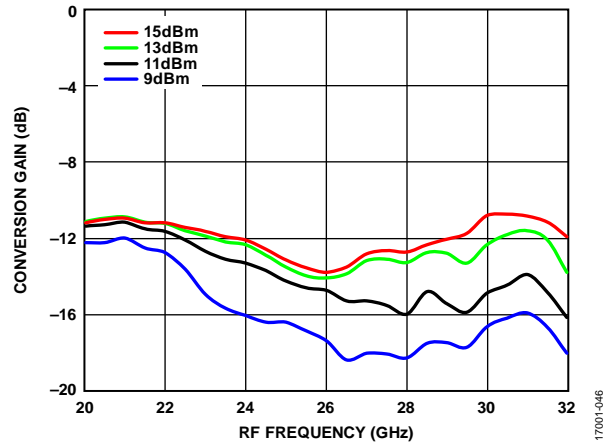

Figure 46. Conversion Gain vs. RF Frequency at Various LO Power Levels,  $T_A = 25^\circ\text{C}$

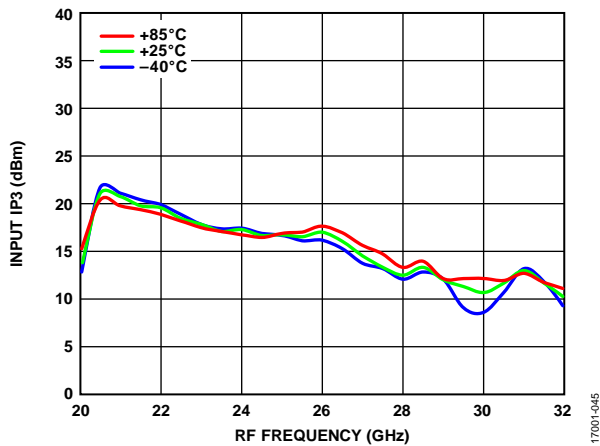

Figure 45. Input IP3 vs. RF Frequency at Various Temperatures, LO = 13 dBm

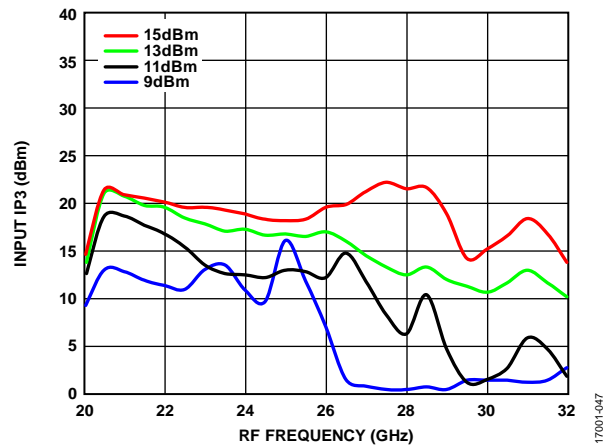

Figure 47. Input IP3 vs. RF Frequency at Various LO Power Levels,  $T_A = 25^\circ\text{C}$

**ISOLATION AND RETURN LOSS**

Downconverter performance at IF = 1 GHz, upper sideband (low-side LO).

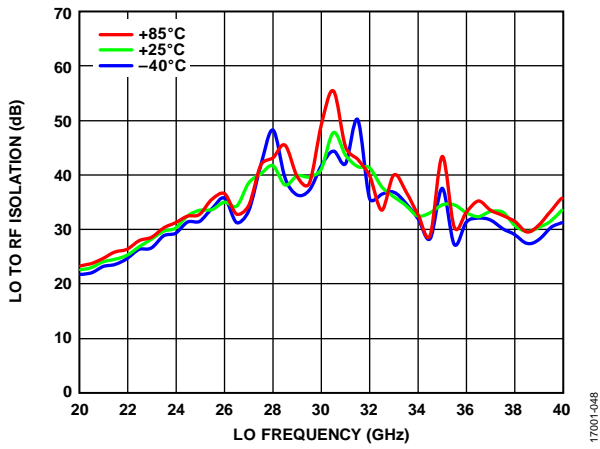

Figure 48. LO to RF Isolation vs. LO Frequency at Various Temperatures, LO = 13 dBm

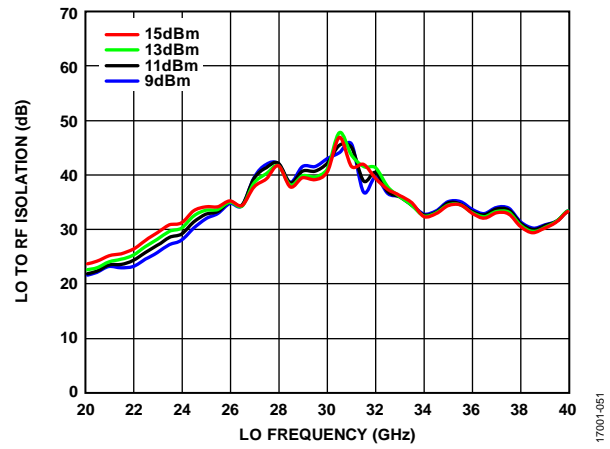

Figure 51. LO to RF Isolation vs. LO Frequency at Various LO Power Levels, TA = 25°C

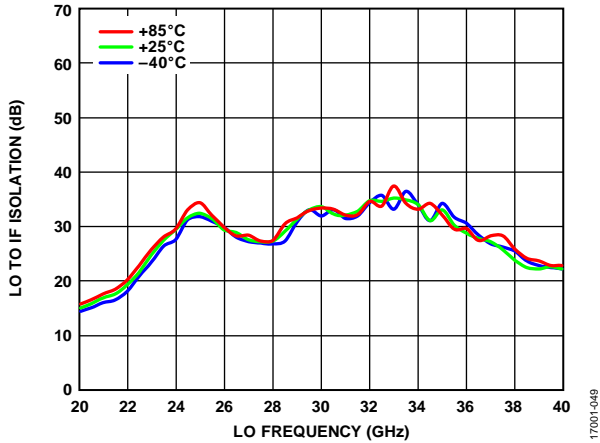

Figure 49. LO to IF Isolation vs. LO Frequency at Various Temperatures, LO = 13 dBm

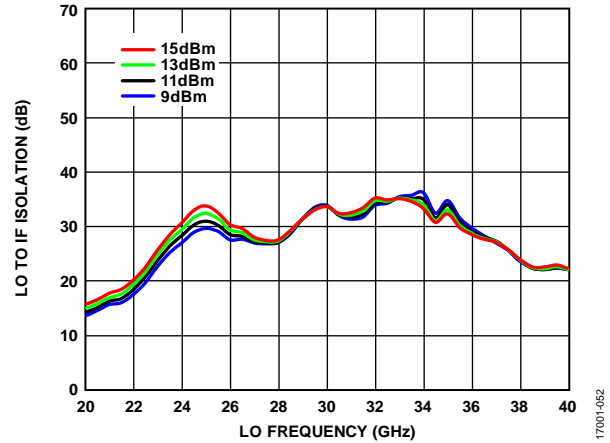

Figure 52. LO to IF Isolation vs. LO Frequency at Various LO Power Levels, TA = 25°C

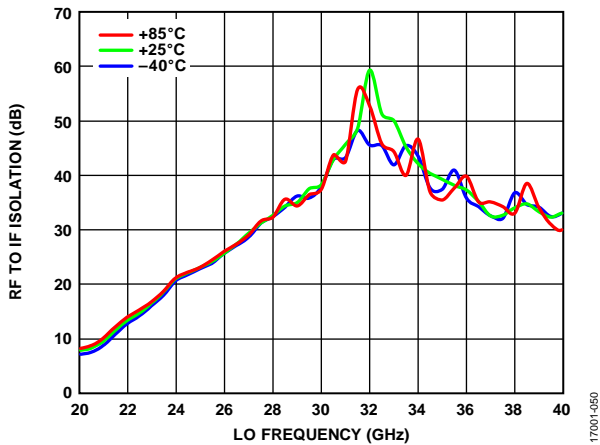

Figure 50. RF to IF Isolation vs. RF Frequency at Various Temperatures, LO = 13 dBm

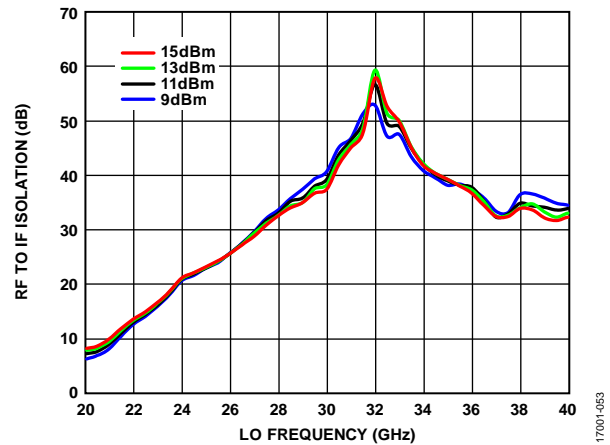

Figure 53. RF to IF Isolation vs. RF Frequency at Various LO Power Levels, TA = 25°C



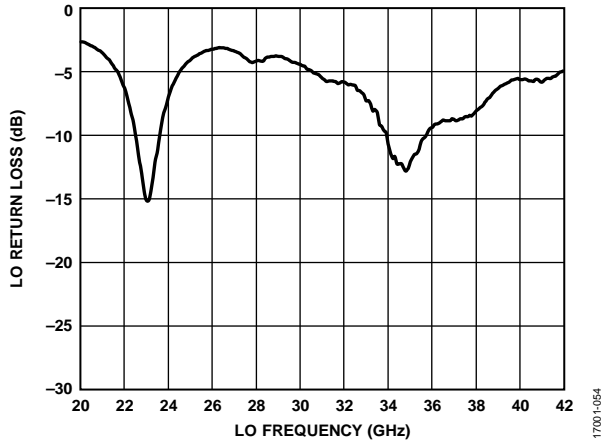

Figure 54. LO Return Loss vs. LO Frequency at Various Temperatures, LO = 13 dBm

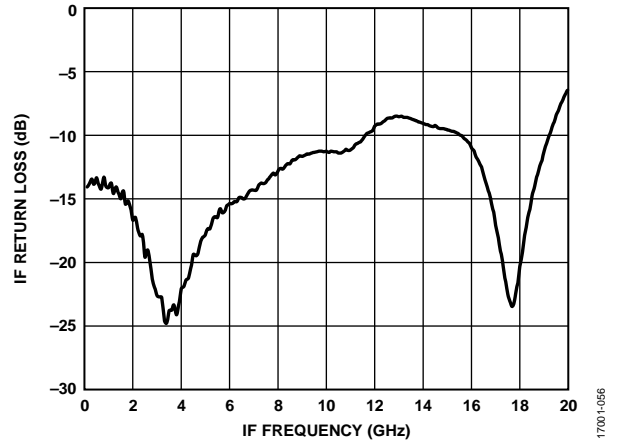

Figure 56. IF Return Loss vs. IF Frequency at Various Temperatures, LO = 29 GHz, 13 dBm

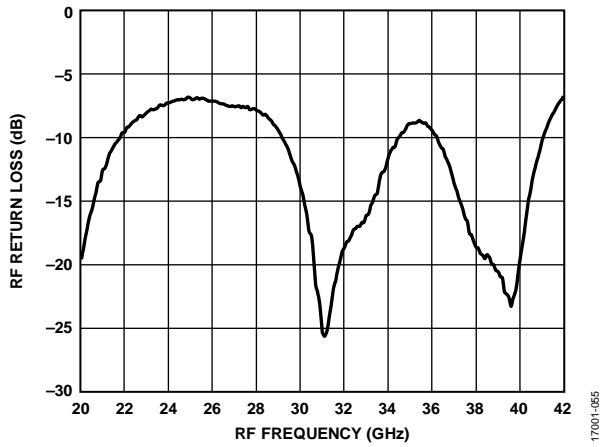

Figure 55. RF Return Loss vs. RF Frequency at Various Temperatures, LO = 29 GHz, 13 dBm

**IF BANDWIDTH—DOWNCONVERTER**

Upper sideband, LO frequency = 24 GHz.

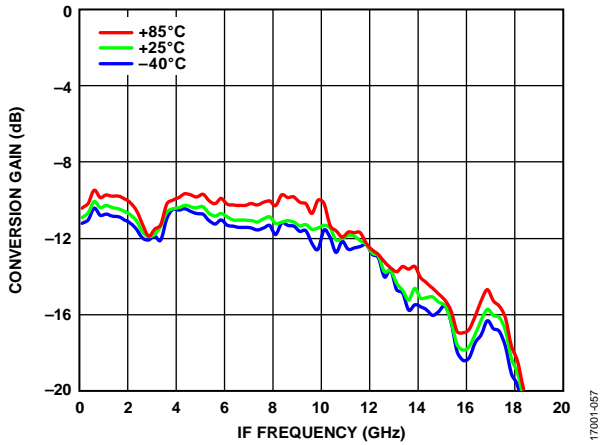

Figure 57. Conversion Gain vs. IF Frequency at Various Temperatures, LO = 13 dBm

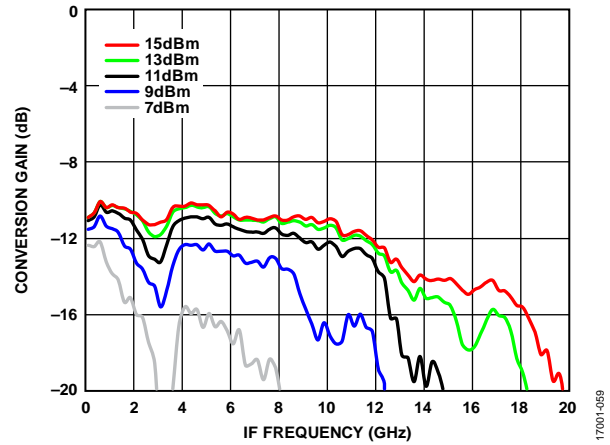

Figure 59. Conversion Gain vs. IF Frequency at Various LO Power Levels,  $T_A = 25^\circ\text{C}$

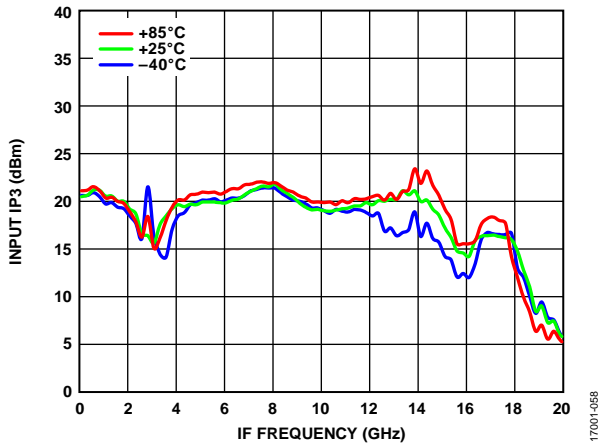

Figure 58. Input IP3 vs. IF Frequency at Various Temperatures, LO = 13 dBm

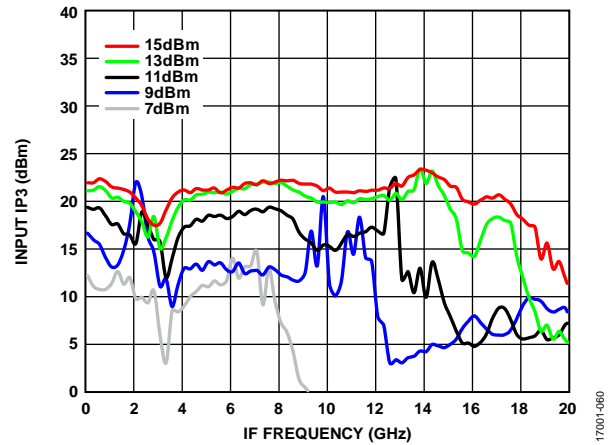

Figure 60. Input IP3 vs. IF Frequency at Various LO Power Levels,  $T_A = 25^\circ\text{C}$

**SPURIOUS AND HARMONICS PERFORMANCE**

Mixer spurious products are measured in dBc from the IF output power level. N/A means not applicable.

**LO Harmonics**

LO power = 13 dBm,  $T_A = 25^\circ\text{C}$ , and all values are in dBc below the input LO level measured at the RF port.

LO Frequency (GHz)	N × LO Spur at the RF Port		
	1	2	3
24	+1	+40	N/A
30	-3	N/A	N/A
36	-19	N/A	N/A

**Downconverter, Upper Sideband, M × N Spurious Outputs**

Mixer spurious products are measured in dBc from the IF output power level. N/A means not applicable.

Spur values are  $(M \times \text{RF}) - (N \times \text{LO})$ . RF = 24 GHz at -10 dBm, LO = 23 GHz at 13 dBm.

M × RF		N × LO				
		0	1	2	3	4
M × RF	0	N/A	1	40	N/A	N/A
	1	10	0	30	40	N/A
	2	61	64	50	60	65
	3	N/A	63	73	61	74
	4	N/A	N/A	60	72	81

**Downconverter, Lower Sideband, M × N Spurious Outputs**

Spur values are  $(M \times \text{RF}) - (N \times \text{LO})$ . RF = 24 GHz at -10 dBm, LO = 25 GHz at 13 dBm.

M × RF		N × LO				
		0	1	2	3	4
M × RF	0	N/A	1	33	N/A	N/A
	1	8	0	32	N/A	N/A
	2	63	57	51	59	N/A
	3	N/A	61	76	63	74
	4	N/A	N/A	63	76	80

**Upconverter, Upper Sideband, M × N Spurious Outputs**

Mixer spurious products are measured in dBc from the RF output power level. N/A means not applicable.

$\text{IF}_{\text{IN}} = 1 \text{ GHz}$  at -10 dBm, LO = 23 GHz at 13 dBm.

M × IF <sub>IN</sub>		N × LO				
		0	1	2	3	4
M × IF <sub>IN</sub>	-4	79	77	65	N/A	N/A
	-3	61	55	64	N/A	N/A
	-2	54	41	56	N/A	N/A
	-1	13	0	31	N/A	N/A
	0	N/A	1	17	N/A	N/A
	+1	13	0	40	N/A	N/A
	+2	54	47	51	N/A	N/A
	+3	61	53	62	N/A	N/A
	+4	92	74	61	N/A	N/A

**Upconverter, Lower Sideband, M × N Spurious Outputs**

$\text{IF}_{\text{IN}} = 1 \text{ GHz}$  at -10 dBm, LO = 25 GHz at 13 dBm.

M × IF <sub>IN</sub>		N × LO				
		0	1	2	3	4
M × IF <sub>IN</sub>	-4	82	76	63	N/A	N/A
	-3	54	46	60	N/A	N/A
	-2	49	38	43	N/A	N/A
	-1	13	0	49	N/A	N/A
	0	N/A	3	10	N/A	N/A
	+1	13	0	N/A	N/A	N/A
	+2	49	47	N/A	N/A	N/A
	+3	54	52	N/A	N/A	N/A
	+4	78	72	N/A	N/A	N/A

## **THEORY OF OPERATION**

The HMC560ALM3 is a general-purpose, double balanced mixer that can be used as an upconverter or a downconverter from 22 GHz to 38 GHz.

When used as a downconverter, the HMC560ALM3 downconverts RF between 22 GHz and 38 GHz to IF values between dc and 18 GHz.

When used as an upconverter, the mixer upconverts IF values between dc and 18 GHz to RF values between 22 GHz and 38 GHz.

The mixer performs well with LO drive values of 13 dBm or greater and provides excellent LO to RF and LO to IF suppression due to optimized balun structures.

## APPLICATIONS INFORMATION

### TYPICAL APPLICATION CIRCUIT

Figure 61 shows the typical application circuit for the HMC560ALM3. The HMC560ALM3 is a passive device and does not require any external components. The LO and RF pins are internally ac-coupled. When IF operation is not required until dc, it is recommended to use an ac-coupled capacitor at the IF port.

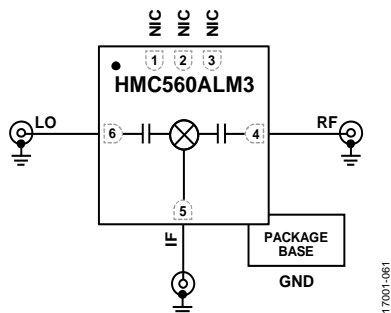

Figure 61. Typical Application Circuit

### EVALUATION PCB INFORMATION

The PCB used in this application must use RF circuit design techniques. Signal lines must have 50  $\Omega$  impedance, and the package ground lead and exposed pad must be connected directly to the ground planes. The grounded coplanar wave guide (CPWG) PCB input/output transitions allow the use of

ground signal ground (GSG) probes for testing. The suggested probe pitch is 400  $\mu\text{m}$  (16 mils). The evaluation circuit board shown in Figure 62 is available from Analog Devices, Inc., upon request.

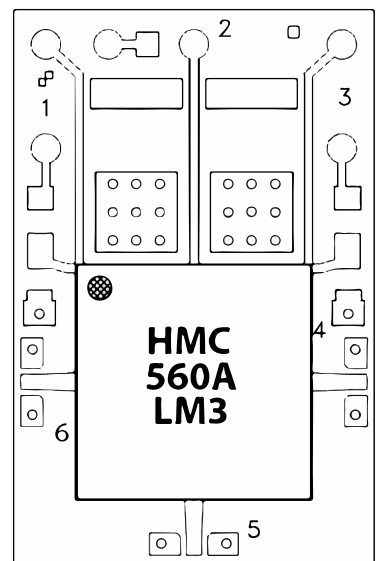

Figure 62. EV1HMC560ALM3 Evaluation PCB

OUTLINE DIMENSIONS

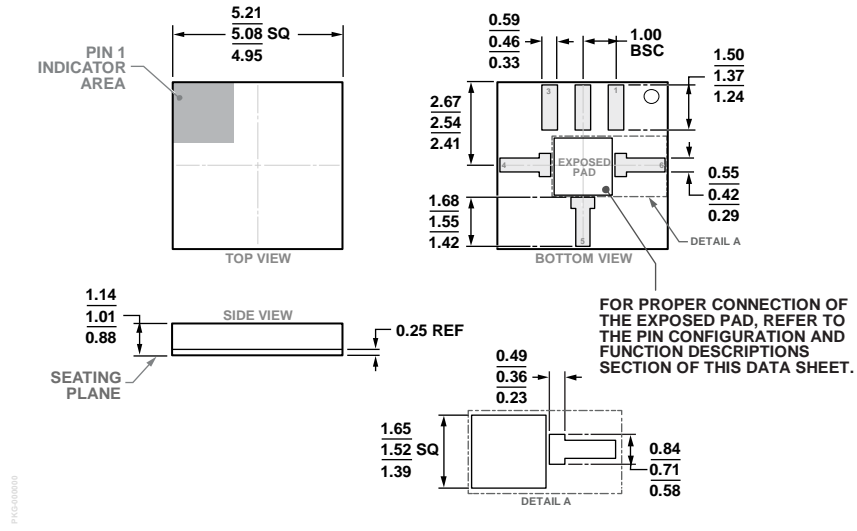

Figure 63. 6-Terminal Chip Array Small Outline No Lead Cavity [LGA\_CAV]  
 5.08 mm x 5.08 mm Body and 1.01 mm Package Height  
 (CE-6-3)  
 Dimensions shown in millimeters

ORDERING GUIDE

Model <sup>1</sup>	Temperature Range	Package Description	Package Option
HMC560ALM3	-40°C to +85°C	6-Terminal Chip Array Small Outline No Lead Cavity [LGA_CAV]	CE-6-3
HMC560ALM3TR	-40°C to +85°C	6-Terminal Chip Array Small Outline No Lead Cavity [LGA_CAV]	CE-6-3
EV1HMC560ALM3		Evaluation PCB Assembly	

<sup>1</sup> The HMC560ALM3 and HMC560ALM3TR are RoHS compliant devices.