

High temperature 4 A sensitive TRIACs

Features

- Medium current TRIAC
- Logic level sensitive TRIAC
- 150 °C max. T_j turn-off commutation
- Clip bounding
- RoHS (2002/95/EC) compliant package

Applications

- The T410H is designed for the control of AC actuators in appliances and industrial systems.
- The multi-port drive of the microcontroller can control the multiple loads of such appliances and systems through this sensitive gate TRIAC.

Description

Specifically designed to operate at 150 °C, the new 4 A T410H TRIAC provides an enhanced performance in terms of power loss and thermal dissipation. This allows the optimization of the heatsink size, leading to space and cost effectiveness when compared to electro-mechanical solutions.

Based on ST logic level technology, the T410H offers an I_{GT} lower than 10 mA and specified minimal commutation and high noise immunity levels valid up to the T_j max.

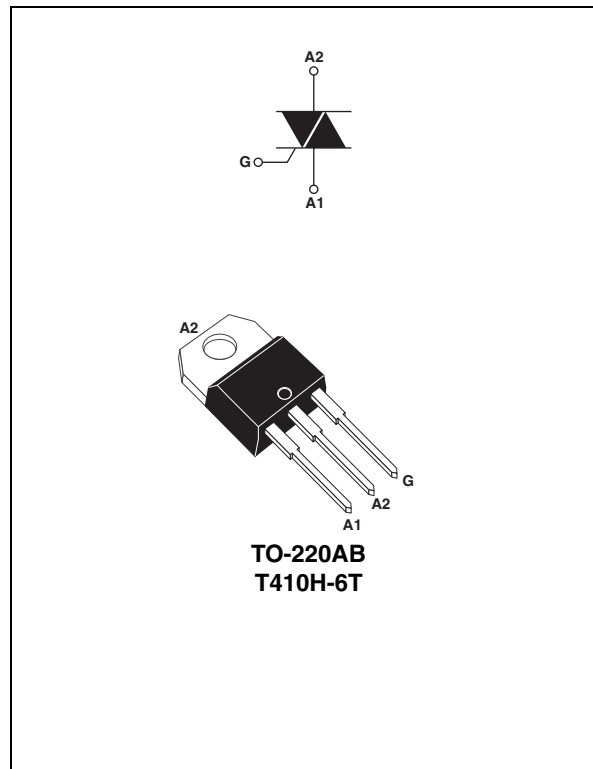

Table 1. Device summary

Symbol	Value	Unit
$I_{T(RMS)}$	4	A
V_{DRM}/V_{RRM}	600	V
$I_{GT MAX}$	10	mA

1 Characteristics

Table 2. Absolute maximum ratings

Symbol	Parameter		Value	Unit	
$I_{T(RMS)}$	On-state rms current (full sine wave)		$T_c = 141\text{ }^\circ\text{C}$	4	A
I_{TSM}	Non repetitive surge peak on-state current (full cycle, T_j initial = $25\text{ }^\circ\text{C}$)	F = 60 Hz	t = 16.7 ms	42	A
		F = 50 Hz	t = 20 ms	40	
I^2t	I^2t Value for fusing	$t_p = 10\text{ ms}$		11	A ² s
dI/dt	Critical rate of rise of on-state current $I_G = 2 \times I_{GT}$, $t_r \leq 100\text{ ns}$	F = 120 Hz	$T_j = 150\text{ }^\circ\text{C}$	50	A/ μs
V_{DSM}/V_{RSM}	Non repetitive surge peak off-state voltage	$t_p = 10\text{ ms}$	$T_j = 25\text{ }^\circ\text{C}$	$V_{DRM}/V_{RRM} + 100$	V
I_{GM}	Peak gate current	$t_p = 20\text{ }\mu\text{s}$	$T_j = 150\text{ }^\circ\text{C}$	4	A
$P_{G(AV)}$	Average gate power dissipation	$T_j = 150\text{ }^\circ\text{C}$		1	W
T_{stg} T_j	Storage junction temperature range Operating junction temperature range			- 40 to + 150 - 40 to + 150	$^\circ\text{C}$

Table 3. Electrical characteristics ($T_j = 25\text{ }^\circ\text{C}$, unless otherwise specified)

Symbol	Test conditions	Quadrant	Min.	Max.	Unit
I_{GT}	$V_D = 12\text{ V}$ $R_L = 33\text{ }\Omega$	I - II - III	1	10	mA
V_{GT}		I - II - III		1.0	V
V_{GD}	$V_D = V_{DRM}$, $R_L = 3.3\text{ k}\Omega$	I - II - III	0.15		V
$I_H^{(1)}$	$I_T = 100\text{ mA}$			25	mA
I_L	$I_G = 1.2 I_{GT}$	I - III		30	mA
		II		35	
$dV/dt^{(1)}$	$V_D = 67\% V_{DRM}$, gate open, $T_j = 150\text{ }^\circ\text{C}$		75		V/ μs
$(dI/dt)_C^{(1)}$	Logic level, $0.1\text{ V}/\mu\text{s}$, $T_j = 150\text{ }^\circ\text{C}$		5.7		A/ms
	Logic level, $15\text{ V}/\mu\text{s}$, $T_j = 150\text{ }^\circ\text{C}$		1.5		

1. For both polarities of A2 referenced to A1.

Table 4. Static characteristics

Symbol	Test conditions			Value	Unit
$V_T^{(1)}$	$I_{TM} = 5.6 \text{ A}$, $t_p = 380 \mu\text{s}$	$T_j = 25 \text{ }^\circ\text{C}$	MAX.	1.5	V
$V_{i0}^{(1)}$	Threshold voltage	$T_j = 150 \text{ }^\circ\text{C}$	MAX.	0.80	V
$R_d^{(1)}$	Dynamic resistance	$T_j = 150 \text{ }^\circ\text{C}$	MAX.	80.0	m Ω
I_{DRM}	$V_{DRM} = V_{RRM}$	$T_j = 25 \text{ }^\circ\text{C}$	MAX.	5	μA
		$T_j = 150 \text{ }^\circ\text{C}$	MAX.	2.2	mA
I_{RRM}	$V_D/V_R = 400 \text{ V}$ (at peak mains voltage)	$T_j = 150 \text{ }^\circ\text{C}$	MAX.	1.75	
		$V_D/V_R = 200 \text{ V}$ (at peak mains voltage)	$T_j = 150 \text{ }^\circ\text{C}$	MAX.	

1. for both polarities of A2 referenced to A1.

Table 5. Thermal resistance

Symbol	Parameter	Value	Unit
$R_{th(j-c)}$	Junction to case (AC)	2.20	$^\circ\text{C/W}$
$R_{th(j-a)}$	Junction to ambient	60	

Figure 1. Maximum power dissipation versus on-state rms current (full cycle)

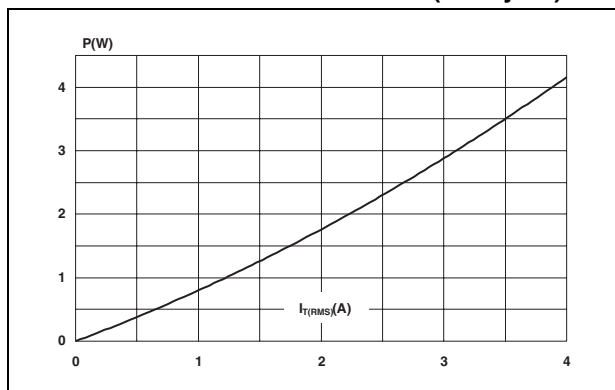

Figure 2. On-state rms current versus case temperature (full cycle)

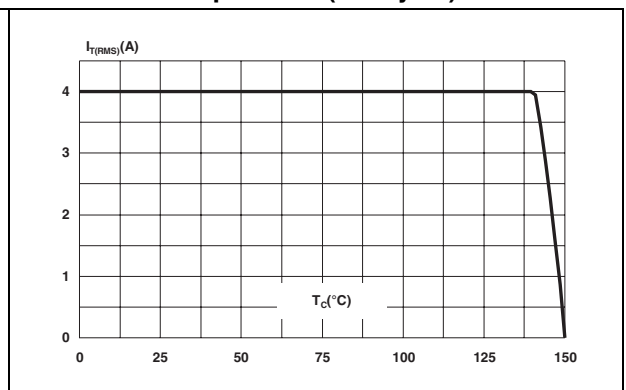

Figure 3. On-state rms current versus ambient temperature (free air convection, full cycle)

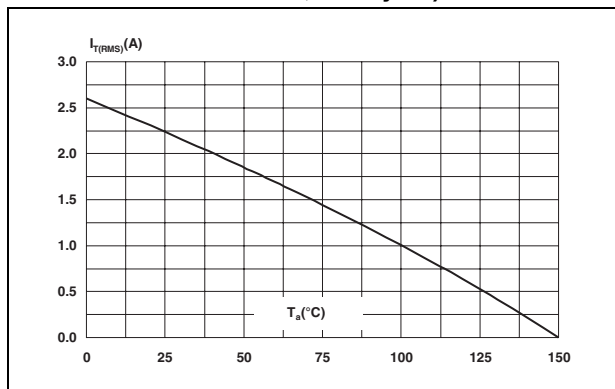

Figure 4. Relative variation of thermal impedance, versus pulse duration

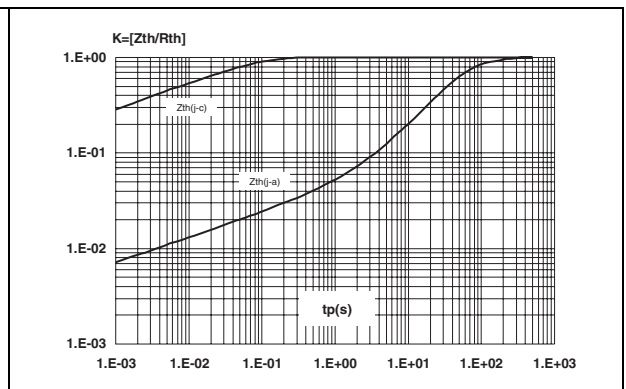

Figure 5. Relative variation of gate trigger current and voltage versus junction temperature (typical values)

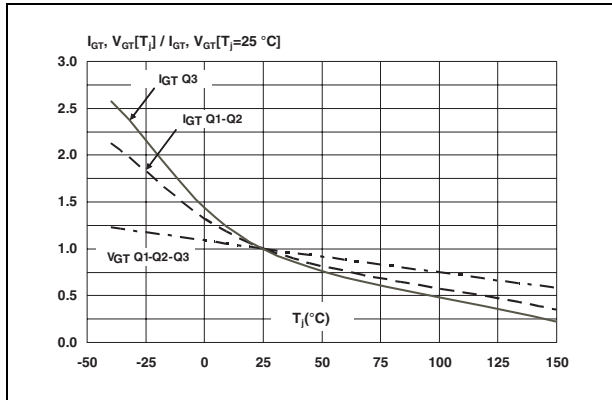

Figure 6. Relative variation of holding and latching current versus junction temperature (typical values)

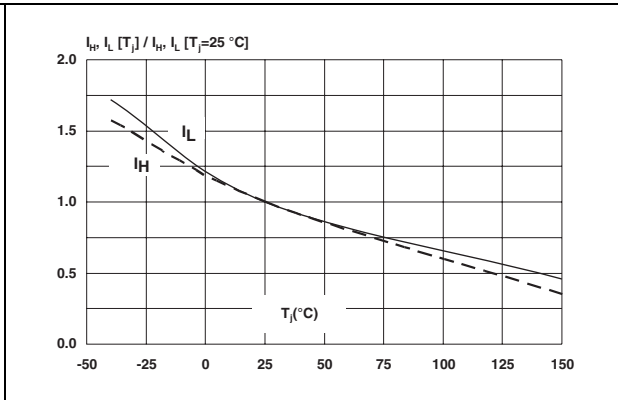

Figure 7. Surge peak on-state current versus number of cycles

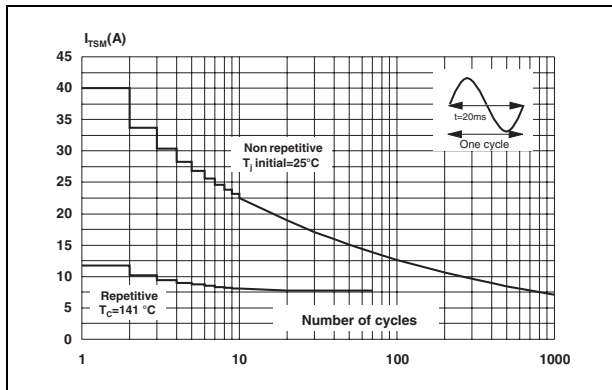

Figure 8. Non-repetitive surge peak on-state current and corresponding value of I^2t

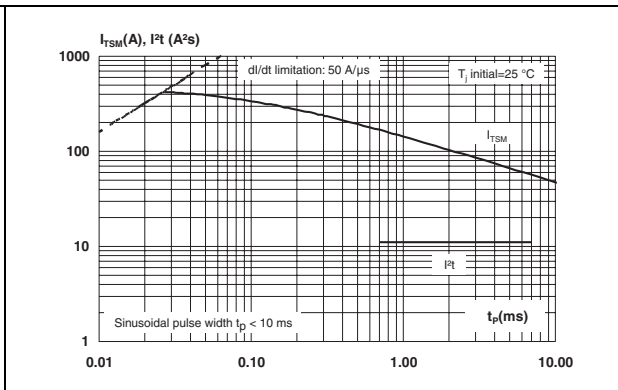

Figure 9. On-state characteristics (maximum values)

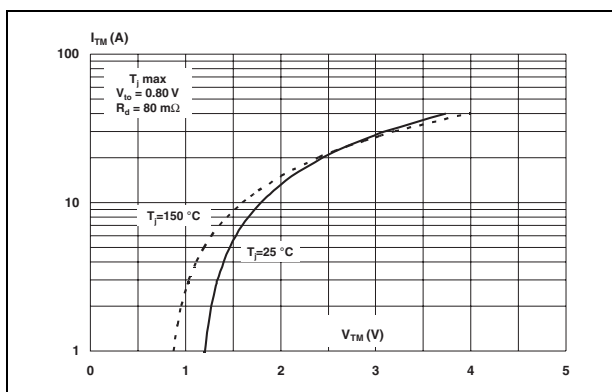

Figure 10. Relative variation of critical rate of decrease of main current versus junction temperature

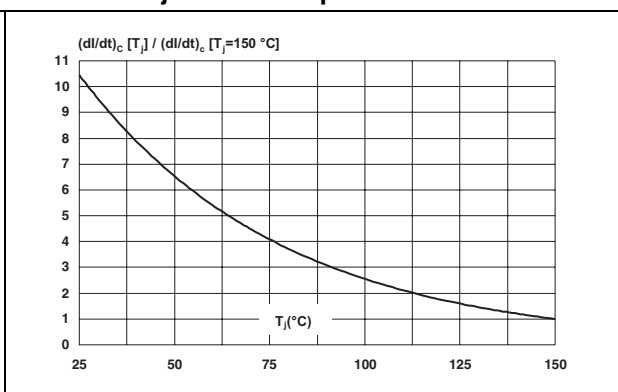

Figure 11. Relative variation of critical rate of decrease of main current versus reapplied dV/dt (typical values)

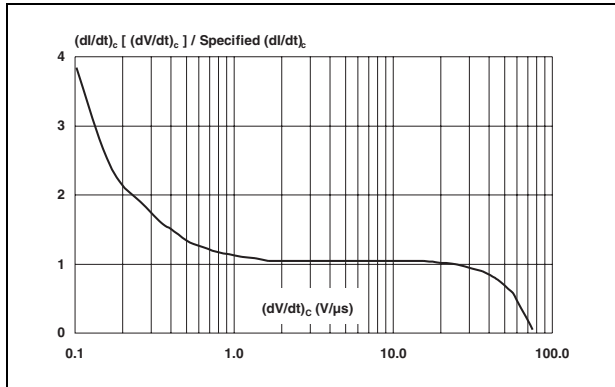

Figure 12. Relative variation of static dV/dt immunity versus junction temperature

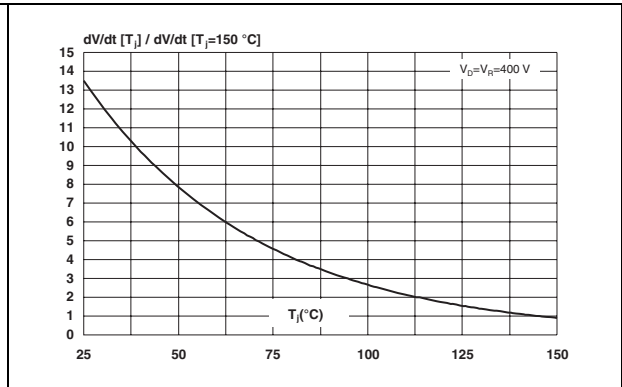

Figure 13. Variation of leakage current versus junction temperature for different values of blocking voltage

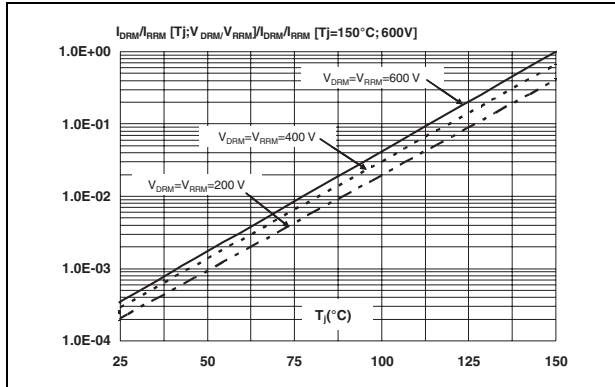
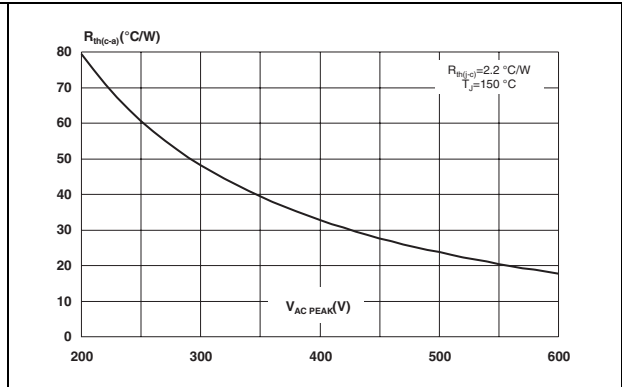
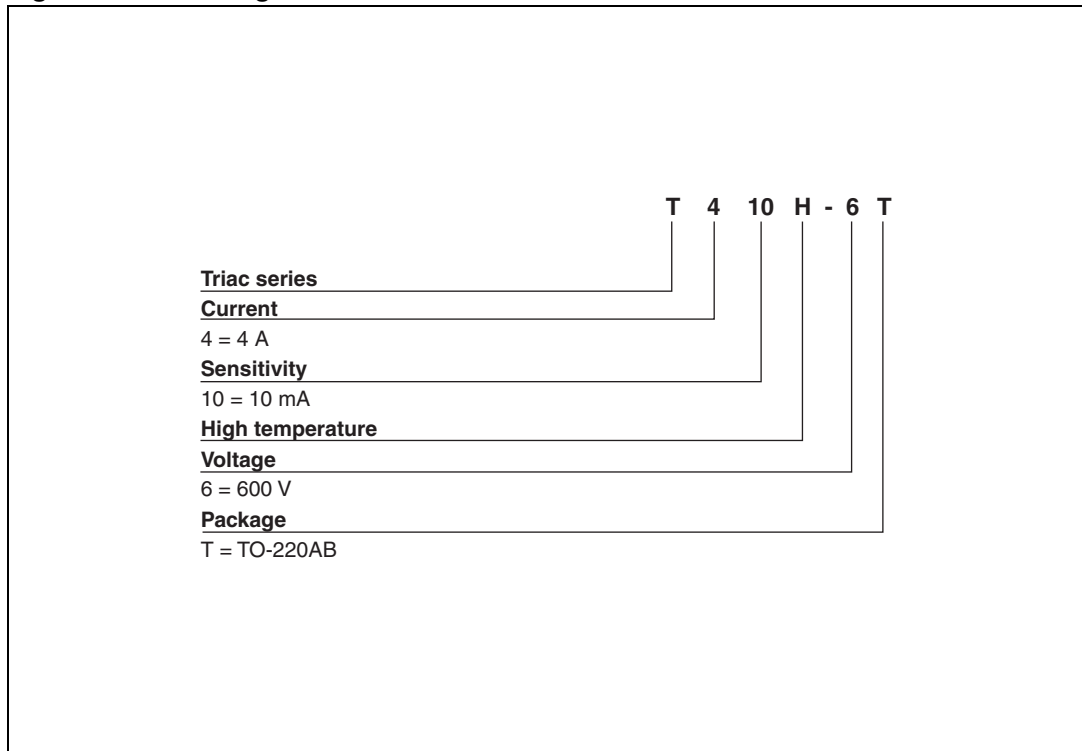

Figure 14. Acceptable case to ambient thermal resistance versus repetitive peak off-state voltage



2 Ordering information scheme

Figure 15. Ordering information scheme



3 Package information

- Epoxy meets UL94, V0
- Recommended torque 0.4 to 0.6 N-m

In order to meet environmental requirements, ST offers these devices in different grades of ECOPACK® packages, depending on their level of environmental compliance. ECOPACK® specifications, grade definitions and product status are available at: www.st.com. ECOPACK® is an ST trademark.

Table 6. TO-220AB dimensions

Ref.	Dimensions					
	Millimeters			Inches		
	Min.	Typ.	Max.	Min.	Typ.	Max.
A	15.20		15.90	0.598		0.625
a1		3.75			0.147	
a2	13.00		14.00	0.511		0.551
B	10.00		10.40	0.393		0.409
b1	0.61		0.88	0.024		0.034
b2	1.23		1.32	0.048		0.051
C	4.40		4.60	0.173		0.181
c1	0.49		0.70	0.019		0.027
c2	2.40		2.72	0.094		0.107
e	2.40		2.70	0.094		0.106
F	6.20		6.60	0.244		0.259
ØI	3.75		3.85	0.147		0.151
I4	15.80	16.40	16.80	0.622	0.646	0.661
L	2.65		2.95	0.104		0.116
I2	1.14		1.70	0.044		0.066
I3	1.14		1.70	0.044		0.066
M		2.60			0.102	

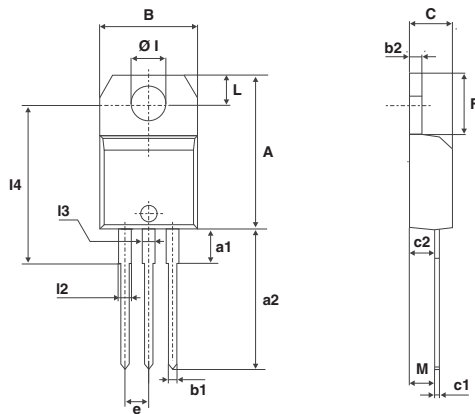

4 Ordering information

Table 7. Ordering information

Order code	Marking	Package	Weight	Base qty	Delivery mode
T410H-6T	T410H 6T	TO-220AB	2.3 g	50	Tube

5 Revision history

Table 8. Document revision history

Date	Revision	Changes
15-May-2009	1	First issue.

Please Read Carefully:

Information in this document is provided solely in connection with ST products. STMicroelectronics NV and its subsidiaries ("ST") reserve the right to make changes, corrections, modifications or improvements, to this document, and the products and services described herein at any time, without notice.

All ST products are sold pursuant to ST's terms and conditions of sale.

Purchasers are solely responsible for the choice, selection and use of the ST products and services described herein, and ST assumes no liability whatsoever relating to the choice, selection or use of the ST products and services described herein.

No license, express or implied, by estoppel or otherwise, to any intellectual property rights is granted under this document. If any part of this document refers to any third party products or services it shall not be deemed a license grant by ST for the use of such third party products or services, or any intellectual property contained therein or considered as a warranty covering the use in any manner whatsoever of such third party products or services or any intellectual property contained therein.

UNLESS OTHERWISE SET FORTH IN ST'S TERMS AND CONDITIONS OF SALE ST DISCLAIMS ANY EXPRESS OR IMPLIED WARRANTY WITH RESPECT TO THE USE AND/OR SALE OF ST PRODUCTS INCLUDING WITHOUT LIMITATION IMPLIED WARRANTIES OF MERCHANTABILITY, FITNESS FOR A PARTICULAR PURPOSE (AND THEIR EQUIVALENTS UNDER THE LAWS OF ANY JURISDICTION), OR INFRINGEMENT OF ANY PATENT, COPYRIGHT OR OTHER INTELLECTUAL PROPERTY RIGHT.

UNLESS EXPRESSLY APPROVED IN WRITING BY AN AUTHORIZED ST REPRESENTATIVE, ST PRODUCTS ARE NOT RECOMMENDED, AUTHORIZED OR WARRANTED FOR USE IN MILITARY, AIR CRAFT, SPACE, LIFE SAVING, OR LIFE SUSTAINING APPLICATIONS, NOR IN PRODUCTS OR SYSTEMS WHERE FAILURE OR MALFUNCTION MAY RESULT IN PERSONAL INJURY, DEATH, OR SEVERE PROPERTY OR ENVIRONMENTAL DAMAGE. ST PRODUCTS WHICH ARE NOT SPECIFIED AS "AUTOMOTIVE GRADE" MAY ONLY BE USED IN AUTOMOTIVE APPLICATIONS AT USER'S OWN RISK.

Resale of ST products with provisions different from the statements and/or technical features set forth in this document shall immediately void any warranty granted by ST for the ST product or service described herein and shall not create or extend in any manner whatsoever, any liability of ST.

ST and the ST logo are trademarks or registered trademarks of ST in various countries.

Information in this document supersedes and replaces all information previously supplied.

The ST logo is a registered trademark of STMicroelectronics. All other names are the property of their respective owners.

© 2009 STMicroelectronics - All rights reserved

STMicroelectronics group of companies

Australia - Belgium - Brazil - Canada - China - Czech Republic - Finland - France - Germany - Hong Kong - India - Israel - Italy - Japan - Malaysia - Malta - Morocco - Philippines - Singapore - Spain - Sweden - Switzerland - United Kingdom - United States of America

www.st.com