

# SGP13N60UF

## Ultra-Fast IGBT

### General Description

Fairchild's UF series of Insulated Gate Bipolar Transistors (IGBTs) provides low conduction and switching losses. The UF series is designed for applications such as motor control and general inverters where high speed switching is a required feature.

### Features

- High speed switching
- Low saturation voltage :  $V_{CE(sat)} = 2.1 \text{ V @ } I_C = 6.5\text{A}$
- High input impedance

### Applications

AC & DC motor controls, general purpose inverters, robotics, and servo controls.

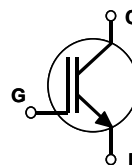

### Absolute Maximum Ratings T<sub>C</sub> = 25°C unless otherwise noted

Symbol	Description	SGP13N60UF	Units
V <sub>CES</sub>	Collector-Emitter Voltage	600	V
V <sub>GES</sub>	Gate-Emitter Voltage	± 20	V
I <sub>C</sub>	Collector Current @ T <sub>C</sub> = 25°C	13	A
	Collector Current @ T <sub>C</sub> = 100°C	6.5	A
I <sub>CM(1)</sub>	Pulsed Collector Current	52	A
P <sub>D</sub>	Maximum Power Dissipation @ T <sub>C</sub> = 25°C	60	W
	Maximum Power Dissipation @ T <sub>C</sub> = 100°C	25	W
T <sub>J</sub>	Operating Junction Temperature	-55 to +150	°C
T <sub>stg</sub>	Storage Temperature Range	-55 to +150	°C
T <sub>L</sub>	Maximum Lead Temp. for Soldering Purposes, 1/8" from Case for 5 Seconds	300	°C

**Notes :**

(1) Repetitive rating : Pulse width limited by max. junction temperature

### Thermal Characteristics

Symbol	Parameter	Typ.	Max.	Units
R <sub>θJC</sub>	Thermal Resistance, Junction-to-Case	--	2.0	°C/W
R <sub>θJA</sub>	Thermal Resistance, Junction-to-Ambient	--	62.5	°C/W

**Electrical Characteristics of the IGBT**  $T_C = 25^\circ\text{C}$  unless otherwise noted

Symbol	Parameter	Test Conditions	Min.	Typ.	Max.	Units
<b>Off Characteristics</b>						
$BV_{CES}$	Collector-Emitter Breakdown Voltage	$V_{GE} = 0V, I_C = 250\mu A$	600	--	--	V
$\Delta BV_{CES}/\Delta T_J$	Temperature Coefficient of Breakdown Voltage	$V_{GE} = 0V, I_C = 1mA$	--	0.6	--	$V/^\circ C$
$I_{CES}$	Collector Cut-Off Current	$V_{CE} = V_{CES}, V_{GE} = 0V$	--	--	250	$\mu A$
$I_{GES}$	G-E Leakage Current	$V_{GE} = V_{GES}, V_{CE} = 0V$	--	--	$\pm 100$	nA
<b>On Characteristics</b>						
$V_{GE(th)}$	G-E Threshold Voltage	$I_C = 6.5mA, V_{CE} = V_{GE}$	3.5	4.5	6.5	V
$V_{CE(sat)}$	Collector to Emitter Saturation Voltage	$I_C = 6.5A, V_{GE} = 15V$	--	2.1	2.6	V
		$I_C = 13A, V_{GE} = 15V$	--	2.6	--	V
<b>Dynamic Characteristics</b>						
$C_{ies}$	Input Capacitance	$V_{CE} = 30V, V_{GE} = 0V,$ $f = 1MHz$	--	375	--	pF
$C_{oes}$	Output Capacitance		--	63	--	pF
$C_{res}$	Reverse Transfer Capacitance		--	13	--	pF
<b>Switching Characteristics</b>						
$t_{d(on)}$	Turn-On Delay Time	$V_{CC} = 300V, I_C = 6.5A,$ $R_G = 50\Omega, V_{GE} = 15V,$ Inductive Load, $T_C = 25^\circ C$	--	20	--	ns
$t_r$	Rise Time		--	27	--	ns
$t_{d(off)}$	Turn-Off Delay Time		--	70	130	ns
$t_f$	Fall Time		--	97	150	ns
$E_{on}$	Turn-On Switching Loss		--	85	--	$\mu J$
$E_{off}$	Turn-Off Switching Loss	--	95	--	$\mu J$	
$E_{ts}$	Total Switching Loss	--	180	270	$\mu J$	
$t_{d(on)}$	Turn-On Delay Time	$V_{CC} = 300V, I_C = 6.5A,$ $R_G = 50\Omega, V_{GE} = 15V,$ Inductive Load, $T_C = 125^\circ C$	--	30	--	ns
$t_r$	Rise Time		--	32	--	ns
$t_{d(off)}$	Turn-Off Delay Time		--	85	200	ns
$t_f$	Fall Time		--	168	250	ns
$E_{on}$	Turn-On Switching Loss		--	180	--	$\mu J$
$E_{off}$	Turn-Off Switching Loss	--	165	--	$\mu J$	
$E_{ts}$	Total Switching Loss	--	345	500	$\mu J$	
$Q_g$	Total Gate Charge	$V_{CE} = 300V, I_C = 6.5A,$ $V_{GE} = 15V$	--	25	35	nC
$Q_{ge}$	Gate-Emitter Charge		--	7	12	nC
$Q_{gc}$	Gate-Collector Charge		--	8	14	nC
$L_e$	Internal Emitter Inductance	Measured 5mm from PKG	--	7.5	--	nH

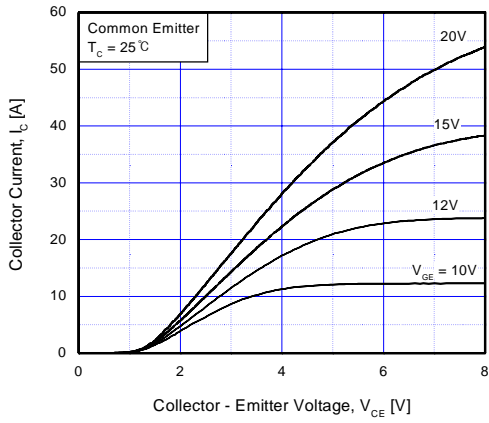

Fig 1. Typical Output Characteristics

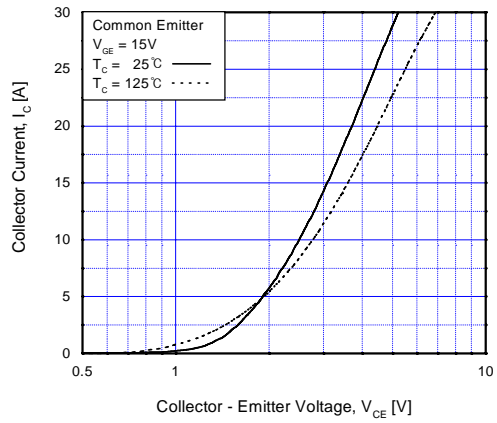

Fig 2. Typical Saturation Voltage Characteristics

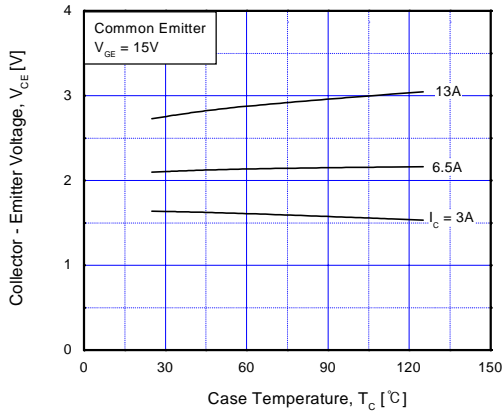

Fig 3. Saturation Voltage vs. Case Temperature at Variant Current Level

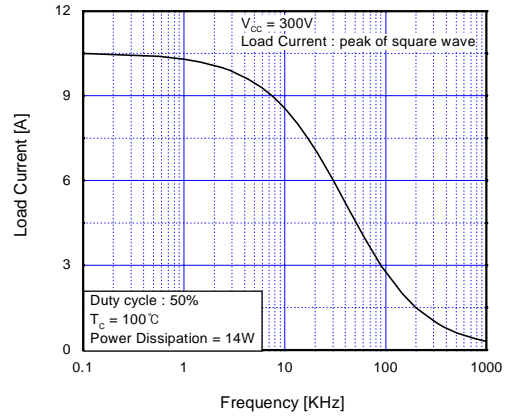

Fig 4. Load Current vs. Frequency

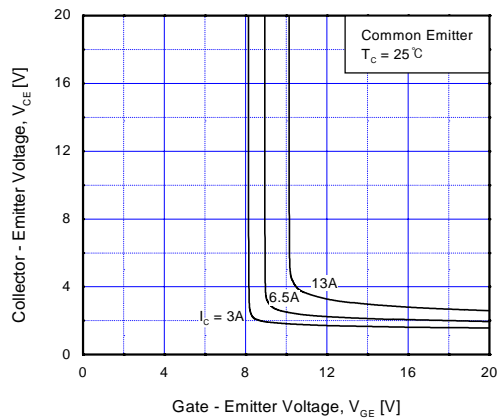

Fig 5. Saturation Voltage vs.  $V_{GE}$

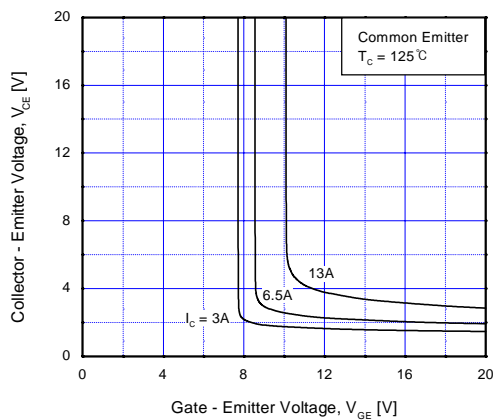

Fig 6. Saturation Voltage vs.  $V_{GE}$

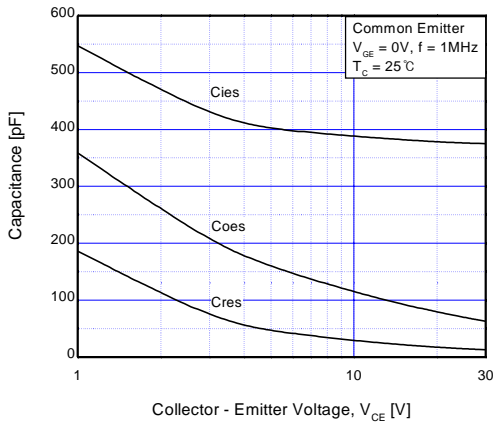

Fig 7. Capacitance Characteristics

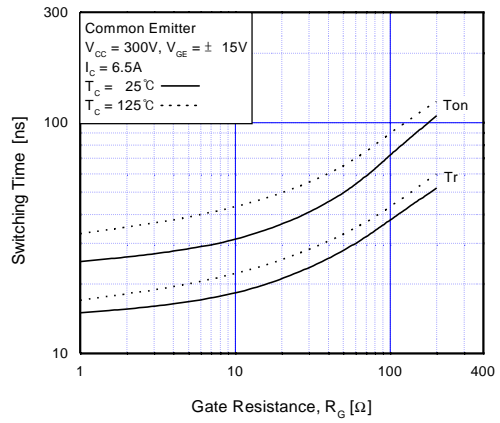

Fig 8. Turn-On Characteristics vs. Gate Resistance

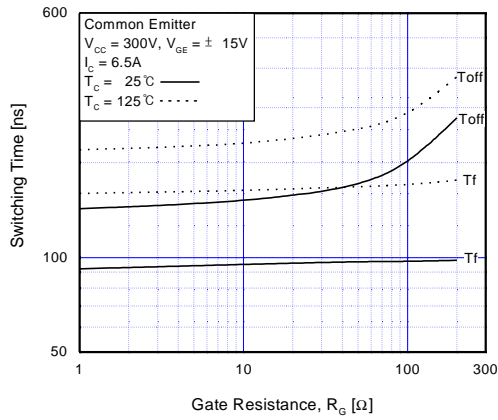

Fig 9. Turn-Off Characteristics vs. Gate Resistance

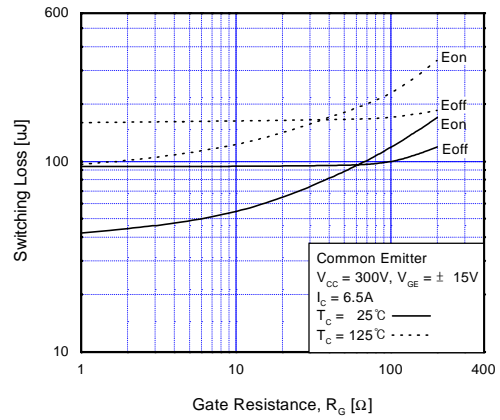

Fig 10. Switching Loss vs. Gate Resistance

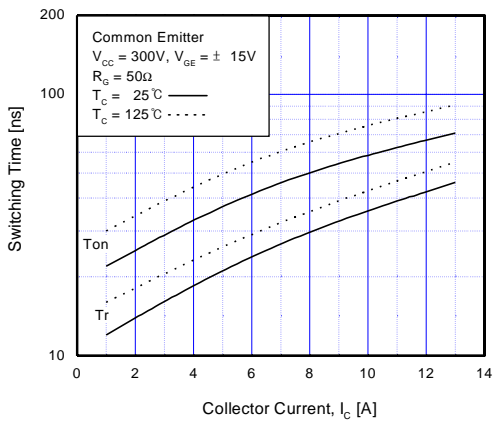

Fig 11. Turn-On Characteristics vs. Collector Current

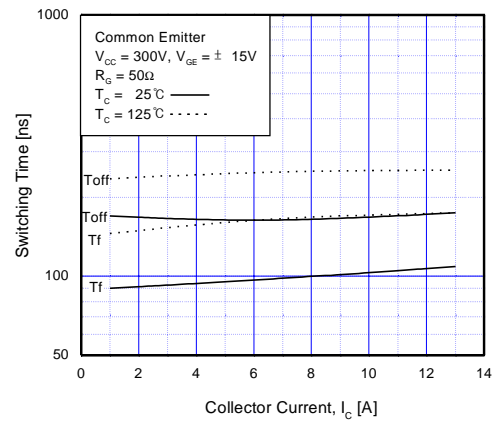

Fig 12. Turn-Off Characteristics vs. Collector Current

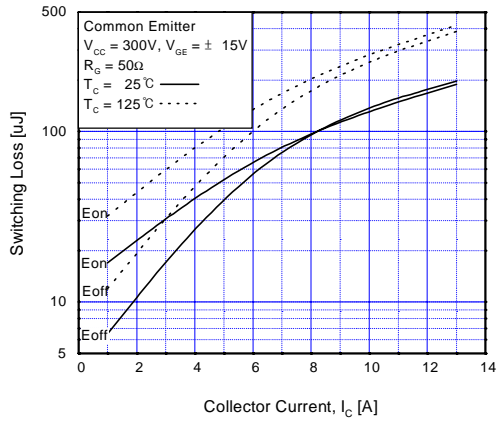

Fig 13. Switching Loss vs. Collector Current

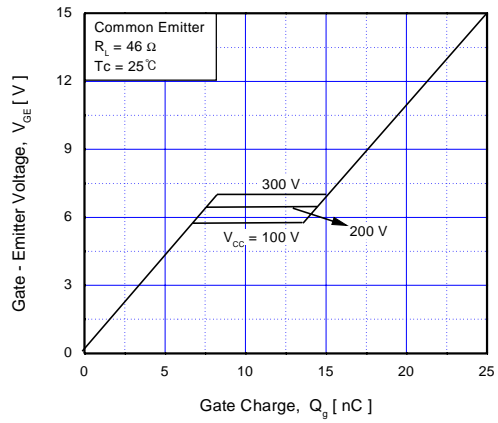

Fig 14. Gate Charge Characteristics

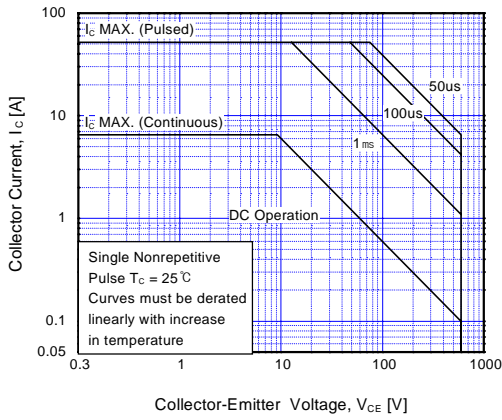

Fig 15. SOA Characteristics

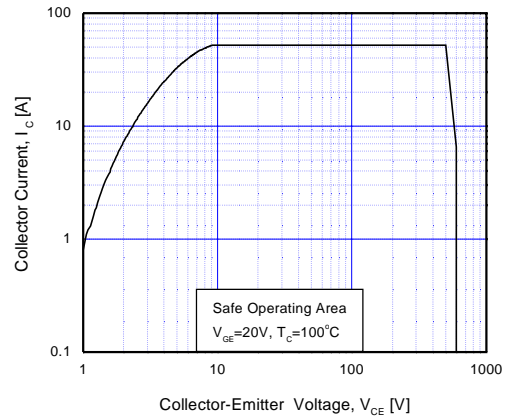

Fig 16. Turn-Off SOA Characteristics

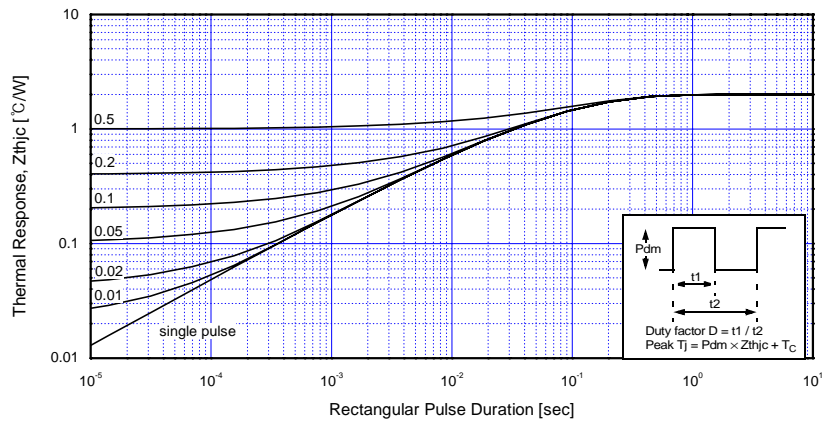
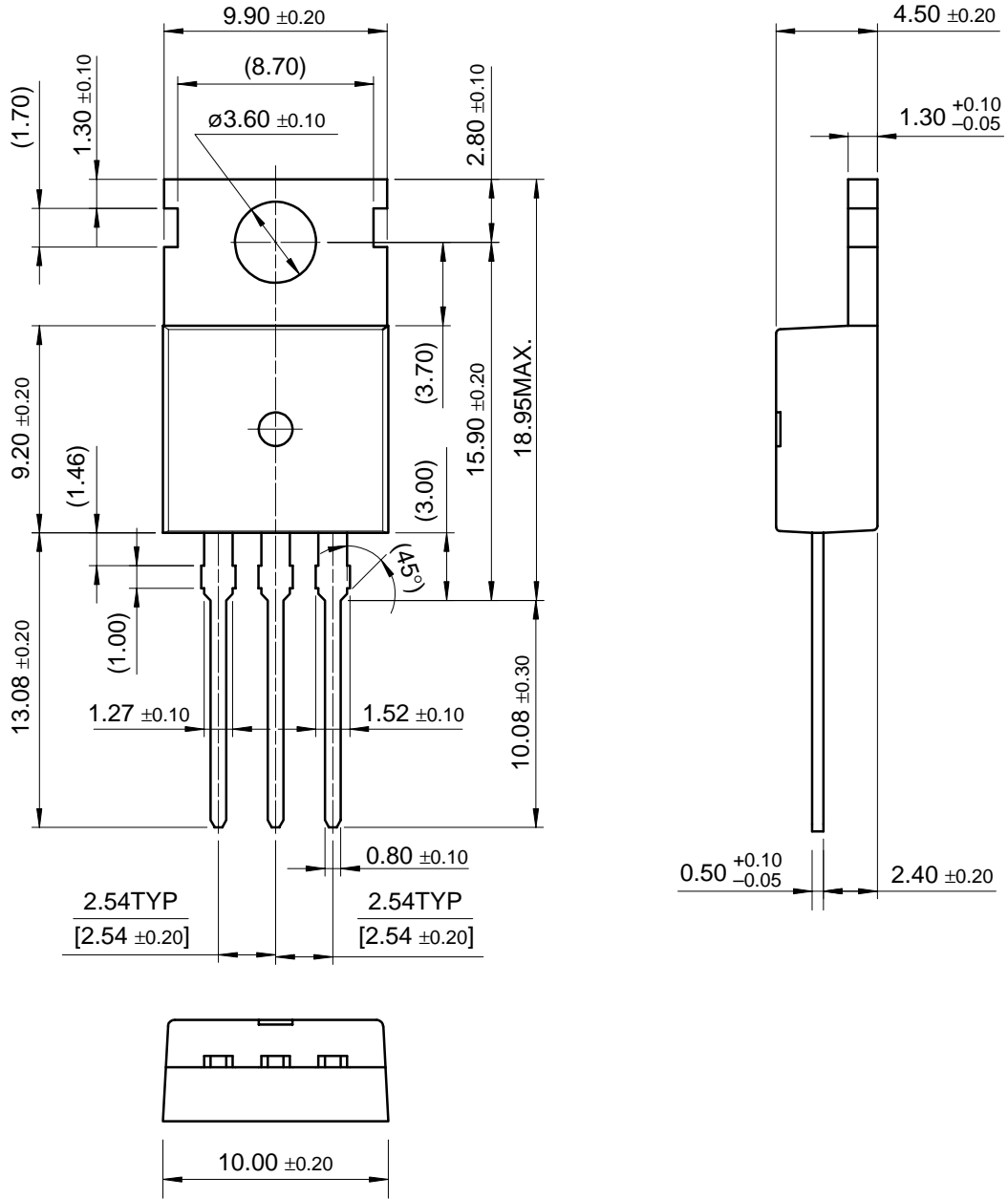

Fig 17. Transient Thermal Impedance of IGBT

Package Dimension

TO-220



Dimensions in Millimeters

## TRADEMARKS

The following are registered and unregistered trademarks Fairchild Semiconductor owns or is authorized to use and is not intended to be an exhaustive list of all such trademarks.

ACEx™	FAST®	MICROWIRE™	SLIENT SWITCHER®	UHC™
Bottomless™	FASTr™	OPTOLOGIC™	SMART START™	UltraFET®
CoolFET™	FRFET™	OPTOPLANAR™	SPM™	VCX™
CROSSVOLT™	GlobalOptoisolator™	PACMAN™	STAR*POWER™	
DenseTrench™	GTO™	POPT™	Stealth™	
DOME™	HiSeC™	Power247™	SuperSOT™-3	
EcoSPARK™	I <sup>2</sup> C™	PowerTrench®	SuperSOT™-6	
E <sup>2</sup> CMOS™	ISOPLANAR™	QFET™	SuperSOT™-8	
EnSigna™	LittleFET™	QS™	SyncFET™	
FACT™	MicroFET™	QT Optoelectronics™	TinyLogic™	
FACT Quiet Series™	MicroPak™	Quiet Series™	TruTranslation™	

STAR\*POWER is used under license

## DISCLAIMER

FAIRCHILD SEMICONDUCTOR RESERVES THE RIGHT TO MAKE CHANGES WITHOUT FURTHER NOTICE TO ANY PRODUCTS HEREIN TO IMPROVE RELIABILITY, FUNCTION OR DESIGN. FAIRCHILD DOES NOT ASSUME ANY LIABILITY ARISING OUT OF THE APPLICATION OR USE OF ANY PRODUCT OR CIRCUIT DESCRIBED HEREIN; NEITHER DOES IT CONVEY ANY LICENSE UNDER ITS PATENT RIGHTS, NOR THE RIGHTS OF OTHERS.

## LIFE SUPPORT POLICY

FAIRCHILD'S PRODUCTS ARE NOT AUTHORIZED FOR USE AS CRITICAL COMPONENTS IN LIFE SUPPORT DEVICES OR SYSTEMS WITHOUT THE EXPRESS WRITTEN APPROVAL OF FAIRCHILD SEMICONDUCTOR CORPORATION.

As used herein:

1. Life support devices or systems are devices or systems which, (a) are intended for surgical implant into the body, or (b) support or sustain life, or (c) whose failure to perform when properly used in accordance with instructions for use provided in the labeling, can be reasonably expected to result in significant injury to the user.
2. A critical component is any component of a life support device or system whose failure to perform can be reasonably expected to cause the failure of the life support device or system, or to affect its safety or effectiveness.

## PRODUCT STATUS DEFINITIONS

### Definition of Terms

Datasheet Identification	Product Status	Definition
Advance Information	Formative or In Design	This datasheet contains the design specifications for product development. Specifications may change in any manner without notice.
Preliminary	First Production	This datasheet contains preliminary data, and supplementary data will be published at a later date. Fairchild Semiconductor reserves the right to make changes at any time without notice in order to improve design.
No Identification Needed	Full Production	This datasheet contains final specifications. Fairchild Semiconductor reserves the right to make changes at any time without notice in order to improve design.
Obsolete	Not In Production	This datasheet contains specifications on a product that has been discontinued by Fairchild semiconductor. The datasheet is printed for reference information only.