

ADXRS450/ADXRS453 Sensor Evaluation System

FEATURES

Flexible inertial sensor evaluation platform

Single main board operates with interchangeable satellite boards

Separates DUT from controller for accurate environmental testing

500 Hz data rate SPI interface

Continuous stream to file data recording

Standard USB cable for power and communications

PC-based graphical user interface (GUI)

Fast, easy installation



Figure 1. Inertial Sensor Evaluation System

GENERAL DESCRIPTION

The [ADXRS450/ADXRS453](#) inertial sensor evaluation system is an easy-to-use evaluation tool targeting bench or desktop characterization of Analog Devices, Inc., inertial sensor products. The system consists of the inertial sensor evaluation board (ISEB), or main board, and satellite boards for several Analog Devices inertial sensor products. The ISEB connects directly to a PC via a USB cable, with the USB connection providing both power and communications to the board. The ISEB is connected to the satellite board through a ribbon cable. This cable allows the satellite to be easily manipulated for testing or separately placed into an environmental chamber for temperature or humidity testing. Separating the boards mitigates corruption of data due to the temperature and humidity effects of other components.

The ISEB is a universal main board and is intended to be used with various satellites of Analog Devices inertial sensors, including analog and digital accelerometers and gyroscopes. The different products are evaluated by means of separate GUIs that are customized for performance and characterization measurements relevant to the inertial sensor being evaluated.

The EVAL-ADXRS450Z-M/ADXRS453Z-M system contains the ISEB and the EVAL-ADXRS450Z-S/ADXRS453Z-S satellite. Also included is a USB A to Mini-B cable to connect the ISEB to a PC and an 18-inch, 20-pin ribbon cable to connect the ISEB to

the satellite. A CD is included with the necessary drivers and installers to use the system and to quickly begin evaluating the [ADXRS450/ADXRS453](#).

INSTALLATION PROCEDURE

The following steps must be completed, in the order listed, to successfully set up and run the [ADXRS450/ADXRS453](#) evaluation system:

1. Install required LabView™ engines.
2. Install the USB drivers for the inertial sensor evaluation system (ISEB).
3. Connect the ISEB hardware to the PC.
4. Install the latest firmware revision into the ISEB hardware (included on the CD-ROM).
5. Install the [ADXRS450/ADXRS453](#) evaluation system GUI.
6. Configure the ISEB hardware.
7. Launch the [ADXRS450/ADXRS453](#) evaluation system GUI and test devices.

This guide is designed to provide all the detail necessary to install and operate the [ADXRS450/ADXRS453](#) evaluation system.

TABLE OF CONTENTS

Features	1	Inertial Sensor Evaluation System Graphical User Interface.....	9
General Description	1	Getting Started.....	9
Installation Procedure.....	1	View and Record Data Panel	10
Revision History	2	Temperature Test Panel	11
Inertial Sensor Evaluation System Setup	3	Noise and Root Allan Variance Panel.....	12
Downloading All Files to a PC	3	Turn-On Bias Stability Panel	13
Installing LabVIEW Files	3	Turn-On Bias Settling Panel	14
ISEB Hardware Setup.....	4	Sensitivity Check Panel.....	15
COM Port Verification	5	Alternate External High Voltage Supply	16
Installing the Latest ISEB Firmware.....	6	Header Pinout	17
Hardware Configuration	7		

REVISION HISTORY

7/11—Revision 0: Initial Version

INERTIAL SENSOR EVALUATION SYSTEM SETUP

DOWNLOADING ALL FILES TO A PC

Before proceeding with the installation routine, you may wish to first download all files included on the Analog Devices Sensor Eval CD-ROM to a local folder on the host PC. This may make installation faster, and is a recommended troubleshooting step if you are experiencing problems with installation. Otherwise, you can install files directly from the CD-ROM. The steps in this user guide assume you are working directly from the CD-ROM.

If you are able to run the Analog Devices ISEB system, you can skip the LabVIEW and driver installation because these are already installed, and proceed directly to the COM Port Verification section.

INSTALLING LabVIEW FILES

The Inertial Sensor Evaluation GUI was developed using LabVIEW and although the GUI is a standalone executable file, it requires installation of the LabVIEW and VISA run-time engines. Follow these steps for installation:

1. To run the software installation routine, double-click the **LabVIEW Run Time Install.exe** file located in the **LabVIEW Run Time Installation** folder on the included CD. The window shown in Figure 2 is displayed. Depending on your version of Windows®, you may be prompted to allow the program to access your computer's settings.

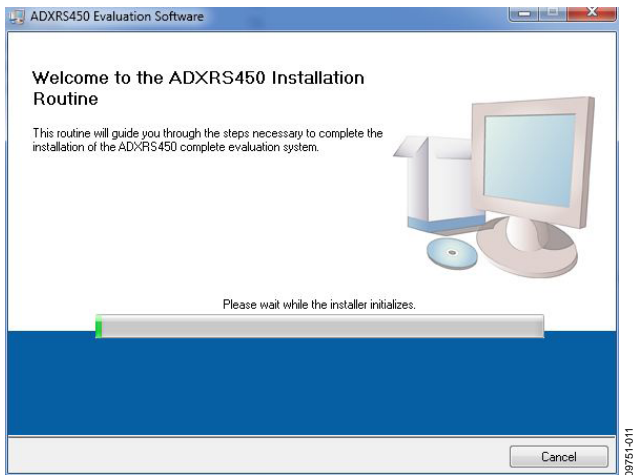

Figure 2. ADXRS450/ADXRS453 Evaluation Software Installation Welcome

2. Select the destination directory. The installer autopopulates the names of the directories in which to store the software GUI and required National Instruments products (see Figure 3). You can change these directories; however, most installations can proceed with the default values.

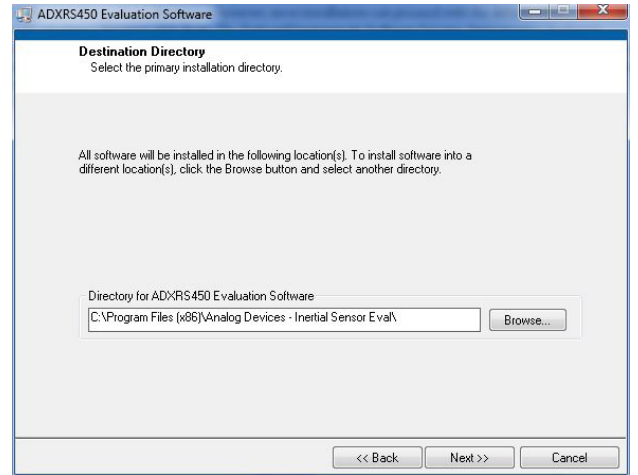

Figure 3. Destination Directory Selection

3. When you finish selecting a directory, click **Next**. The **National Instruments Software License Agreement** is displayed.
4. Read the license agreement before accepting it; then, click **Next**. The installer lists the required components to install on your PC (see Figure 4).

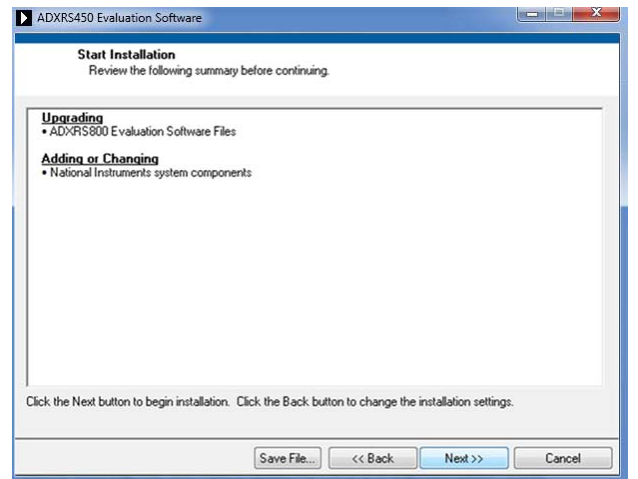

Figure 4. Start Installation (Listing Varies Based on PC Requirements)

- To start the installation, click **Next**. The installer completes installation of the software evaluation GUI and all required National Instruments drivers and run-time engines. After the installation is complete, the box shown in Figure 5 is displayed.

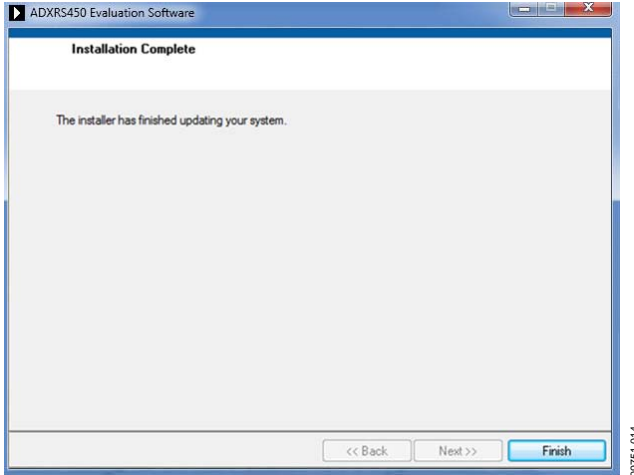

Figure 5. Installation Complete

- Click **Finish** to complete the installation. Reboot your computer if prompted.

ISEB HARDWARE SETUP

Before connecting the ISEB hardware to the PC via the included USB cable, drivers must be installed so that the PC properly recognizes the ISEB main board. The USB drivers for the ISEB are available in the /ISEB_USB/ folder on the packaged CD.

Installing the USB Drivers for the ISEB

To install the USB drivers, follow these steps:

- Open the /ISEB_USB/ folder and locate the appropriate folder for your operating system. If running Windows 7, follow the instructions at /ISEB_USB/ADI_ISEB_Win7/. For other versions of Windows (2000, XP, or Vista), execute the ADI_ISEB_USB_Drivers.exe file located in /ISEB_USB/ADI_ISEB_XP_Vista_2000/ and continue to Step 2.
- Follow the on-screen instructions to install the drivers.
- Click **Continue Anyway** when prompted that the drivers are not tested.

After the preceding steps are complete, you can connect the ISEB main board to the computer via the included USB cable. If the previously installed drivers are not automatically associated with the device, you may need to select the drivers manually, as follows:

- Connect the USB A to Mini-B cable to the PC and then to the ISEB. The satellite board does not need to be connected for this step. New hardware is detected upon completion of this step.
- If prompted to install drivers again, click **Install from a list or specific location (Advanced)** (see Figure 6); then click **Next**.

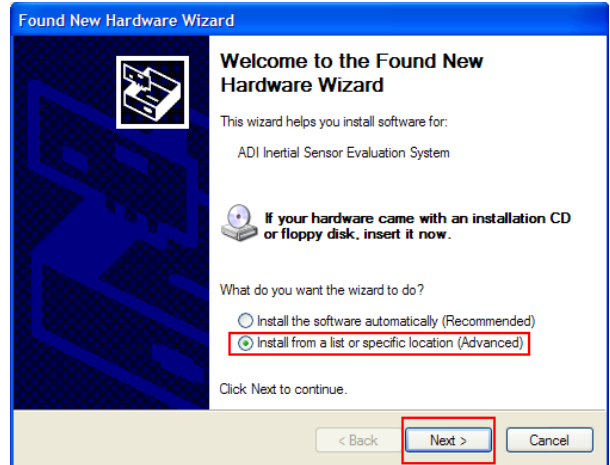

Figure 6. Found New Hardware Prompt

- Select **Don't search. I will choose the driver to install** (see Figure 7), and click **Next**.

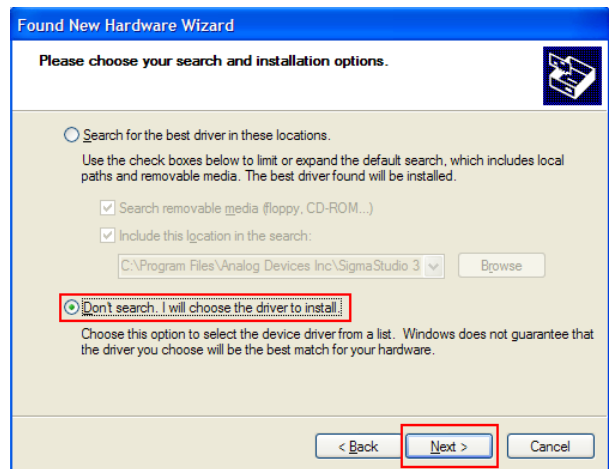

Figure 7. Selection of the Driver to Install

- Select **ADI Inertial Sensor Evaluation System** from the model list (see Figure 8), and click **Next** to complete the process.

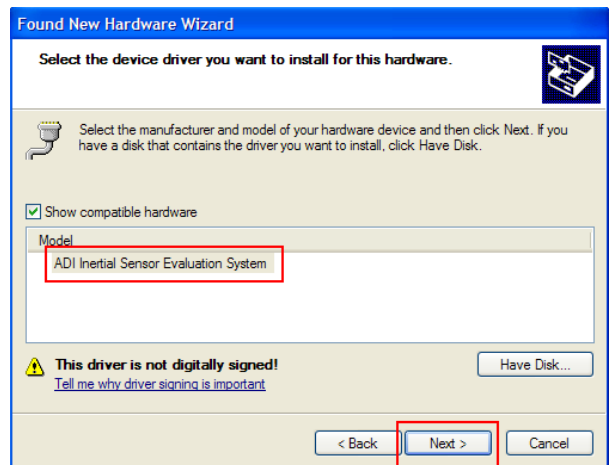

Figure 8. Selection of the ADI Inertial Sensor Evaluation System Drivers

The ISEB should be detected automatically in the **Device Manager** as the **ADI Inertial Sensor Evaluation System** under the **Ports (COM & LPT)** selection. It is recommended to open the **Device Manager** to verify hardware detection and to record the communication port associated with the ISEB for use in the GUI.

COM PORT VERIFICATION

Installing the latest firmware revision, as well as operating the [ADXRS450/ADXRS453](#) evaluation GUI, requires that you know which communications port is assigned to the ISEB main board. With the ISEB main board connected to the PC, perform the following steps in the Windows Vista section, the Windows XP/Windows 2000 section, or the Windows 7 section (depending on your system) to determine the assigned COM port number.

Windows Vista

1. From the **Start** menu, right click **Computer** and select **Properties**. The window shown in Figure 9 should open.
2. Underneath **Tasks**, select **Device Manager**. Windows Vista may request that you allow access to this panel, and administrative privileges may also be required. The window shown in Figure 10 should now open.
3. Expand the **Ports (COM & LTP)** list item. **ADI Inertial Sensor Evaluation System** should be listed with an assigned COM port number in parentheses.
4. Note the COM port number for future use.

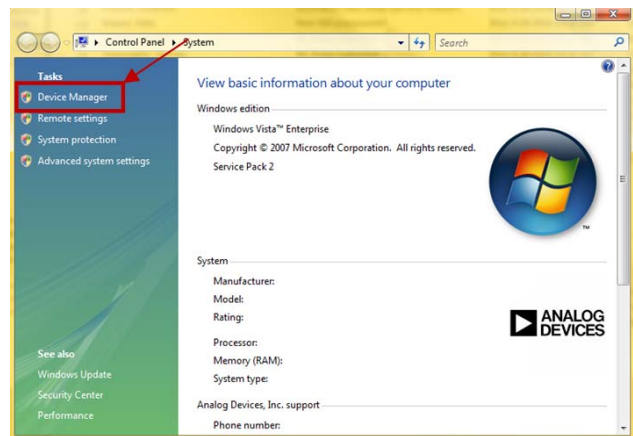

Figure 9. Computer Properties

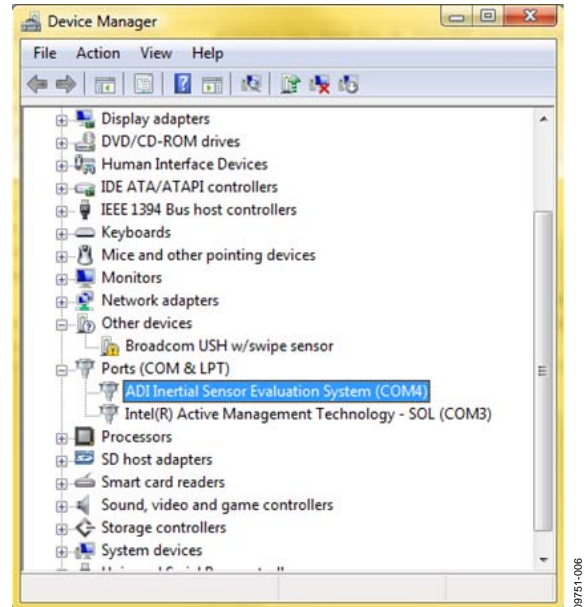

Figure 10. Device Manager Showing the COM Port Number

Windows XP/Windows 2000

1. From the **Start** menu, right click **My Computer** and select **Properties**.
2. Click the **Hardware** tab of the **System Properties** window, as shown in Figure 11.
3. Select **Device Manager** to look up the assigned COM port of the ISEB hardware.

The **Device Manager** window should look like the window shown in Figure 10.

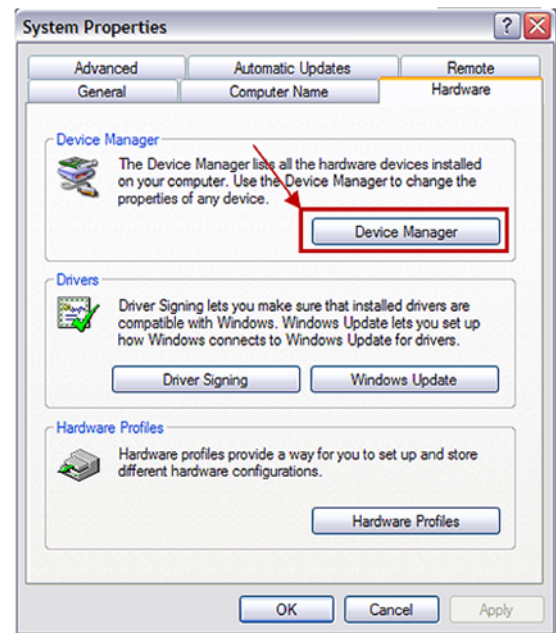

Figure 11. Windows XP/Windows 2000 System Properties

Windows 7

1. From the **Start** menu, right click **My Computer** and select **Properties**.
2. In the upper left corner of the window that opens, select **Device Manager**, shown in Figure 12. Windows 7 may request that you allow access to this panel.
3. Select **Device Manager** to look up the assigned COM port of the ISEB hardware.

The **Device Manager** window should look like the window shown in Figure 10.

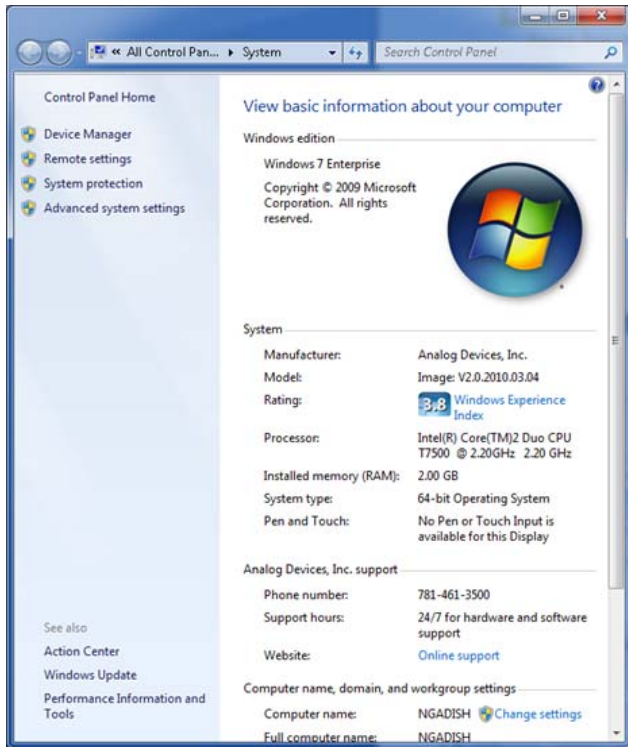

Figure 12. Windows 7 System Properties

INSTALLING THE LATEST ISEB FIRMWARE

The latest ISEB firmware is included on the installation CD. To successfully use the ISEB evaluation hardware, this firmware must be flashed to the ISEB controller. The installation CD contains the firmware itself and the utility that allows you to flash a new version of the firmware onto the ISEB microcontroller. In addition, as new firmware is made available, it can be downloaded from the Analog Devices website (<http://www.analog.com/iseb>).

To flash the ISEB microcontroller, follow these steps:

1. Ensure that the ISEB is connected to and detected by the PC. The COM port on which the device is recognized must also be obtained, as mentioned in the COM Port Verification section.
2. Run the **ARMWSD.exe** program located in the **/Firmware Utility/** folder on the CD. This is the GUI for loading firmware onto the microcontroller; a screenshot is shown in Figure 13.

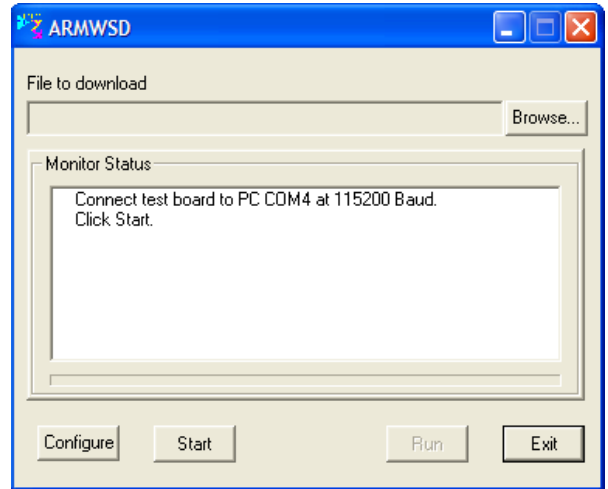

Figure 13. ISEB ARMWSD Firmware Downloader

3. Click **Browse...** and find the **/Firmware Utility/** folder on the CD. Select the **ADXRS450 - ADXRS800 - Firmware.hex** file and click **Open**.
4. Click **Configure** to display the box shown in Figure 14.

The downloader file should be configured for the **ADuC7026** microcontroller on the ISEB. The only option you may need to change is the COM port. You can select the correct port from the **Serial Port** menu on the **Comms** tab (see Figure 14).

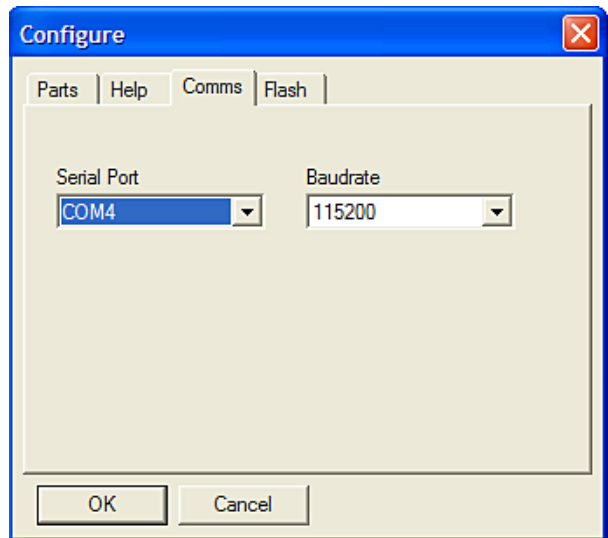

Figure 14. Selecting the Correct COM Port for the Downloader

When the COM port is selected, click **OK** to accept the changes and go back to the **ARMWSD** window (shown in Figure 13).

When the ISEB is connected, the correct firmware is selected, and the downloader is fully configured, follow these steps to flash the firmware:

1. Click **Start** in the **ARMWSD** box (see Figure 13) to initiate the flashing process. Press the two buttons (shown in Figure 15) on the ISEB in the following order to flash the firmware:
 - a. Press and hold down **SW1**.
 - b. With **SW1** held down, press and release **SW2**.
 - c. Release **SW1**.

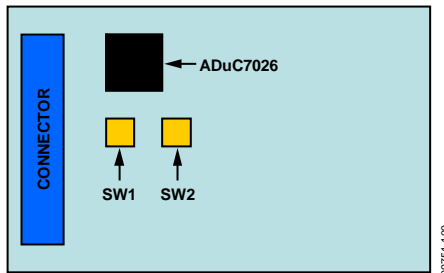

Figure 15. ISEB Switch Locations for Flashing the Microcontroller

The download begins and is automatically verified by the downloader.

2. If the downloading process fails, which is indicated in the **Monitor Status** box (see Figure 13), attempt the download again by clicking **Start** and then pressing the switch combination in Step 1. It may take a few attempts to reprogram the board successfully. Ensure that the cables and boards are stationary during programming to prevent loose connections.
3. After the download has completed successfully, click **Run** (as shown in Figure 13) to reset the ISEB and to begin running the new firmware. When this step is complete, the board is updated correctly.

Updating the firmware may require that a new evaluation GUI be obtained. If the firmware on the CD is used to flash the ISEB, the evaluation GUI on the corresponding CD is sufficient. If the firmware used is obtained from the Analog Devices website (<http://www.analog.com/iseb>), the most recent version of the evaluation GUI, which is also located on the Analog Devices website, should be used.

Installing the ADXRS450/ADXRS453 Software Evaluation GUI

With all the drivers and firmware in place, follow these steps to install the evaluation GUI.

1. Browse to **/ADXRS450/ADXRS450 Eval Software Installation/** on the CD and double-click on **ADXRS450 Install.exe**. Depending on your Windows settings, you may be prompted to allow the program access to your computer. The window that opens will be similar to Figure 3.
2. Follow the on-screen instructions to install the GUI. The installer will place the GUI in your **Start Menu** under **Analog Devices – Inertial Sensor Eval**. If you install or have installed other inertial sensor evaluation GUIs, they will also be in this folder, identified by the corresponding part number.

HARDWARE CONFIGURATION

To configure the hardware, follow these steps:

1. If the hardware is not already connected, plug the USB A to Mini-B cable into the PC.
2. Connect the ISEB to the USB cable.
3. If prompted to install the device, see the Downloading All Files to a PC section for details on how to install and select the correct driver.
4. Ensure that the jumpers on the **ADXRS450/ADXRS453** satellite are in their default configuration, as shown in Figure 16. This sets up the board to use the on-board boost converter to generate the required high voltage supply for the device. For more information on using alternate high voltage supplies, see the **ADXRS450** and **ADXRS453** data sheets and the **Alternate External High Voltage Supply** section of this guide.

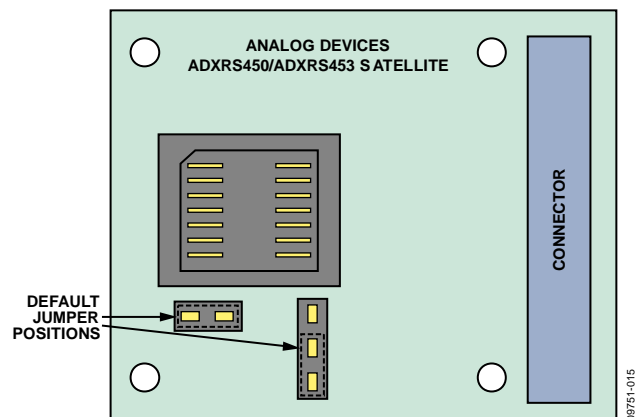

Figure 16. Default Jumper Positions

5. Connect the ISEB to the ADXRS450/ADXRS453 satellite using the 18-inch, 20-pin ribbon cable. This cable is keyed to prevent inserting it backward and causing damage to the system.
6. Connect the [ADXRS450/ADXRS453](#) satellite to the opposite end of the ribbon cable.

The inertial sensor evaluation system should now be set up and ready to use and should resemble the setup shown in Figure 17.

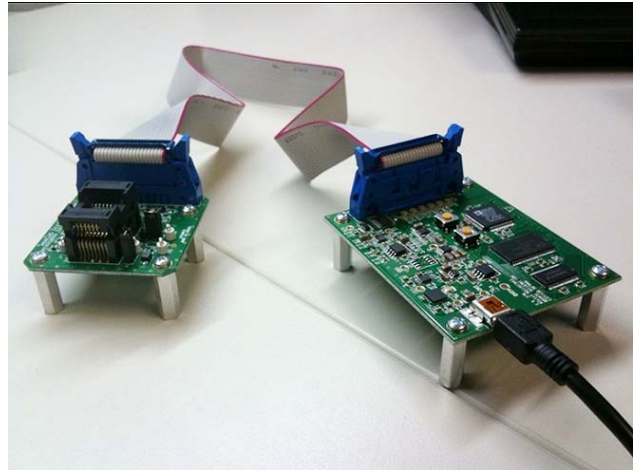

Figure 17. Fully Assembled Evaluation Kit

INERTIAL SENSOR EVALUATION SYSTEM GRAPHICAL USER INTERFACE

The following sections describe the operation of the GUI and the specific purpose of each of its six panels.

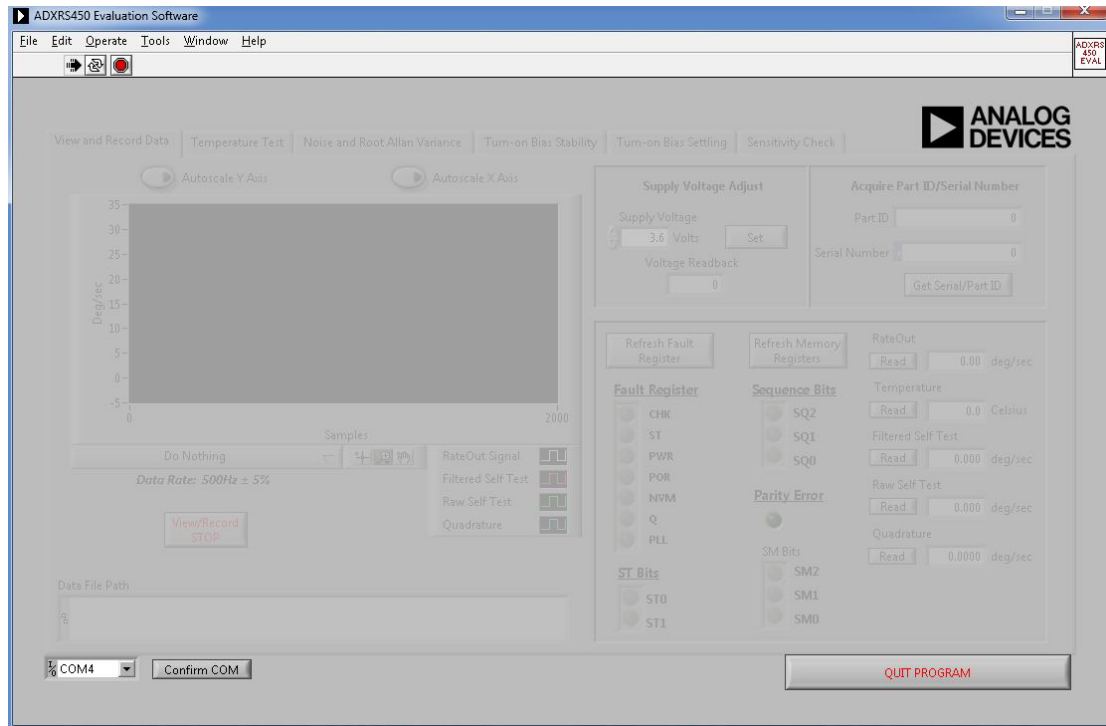

Figure 18. ADXRS450/ADXRS453 Evaluation GUI Startup

09751-017

GETTING STARTED

Before running the software evaluation GUI, it is a good idea to reset the ISEB by pressing the SW2 button described in the Installing the Latest ISEB Firmware section. This removes any errors that may be lingering due to an improper shutdown or disconnection from the PC.

After completion of the software GUI installation routine, a shortcut to launch the executable file is added to the **Start** menu. To launch the evaluation GUI, click **Start**, then **All Programs, Analog Devices – Inertial Sensor Eval, ADXRS450 Evaluation Software**, and finally **ADXRS450 Eval**. A window similar to the one shown in Figure 18 is displayed.

At this point, the functionality of the GUI is completely deactivated. Before testing any devices, you must associate the software GUI with the previously installed hardware via the COM port. Follow the instructions in the COM Port Verification section to determine which COM port is assigned to the Analog Devices Inertial Sensor Evaluation System. Select this COM port from the drop-down list, and click **Confirm COM** to begin using the GUI.

After the COM port is confirmed, the full functionality of the software evaluation GUI is available for you to use. You can exit the GUI at any time by clicking **QUIT PROGRAM** located in the lower right of the start-up window.

Troubleshooting

If the ISEB board and the software evaluation GUI do not appear to be properly communicating, perform the following reset routine:

1. Close the software GUI by clicking **QUIT PROGRAM** or by selecting **File/Exit**.
2. When the software GUI is closed, reset the ISEB evaluation board by pressing the reset button (SW2).
3. Restart the software GUI.

Note that you should not press the reset button (SW2) while the GUI is running. This causes the ISEB and the software GUI to disconnect from each other and causes the evaluation system to no longer function properly.

VIEW AND RECORD DATA PANEL

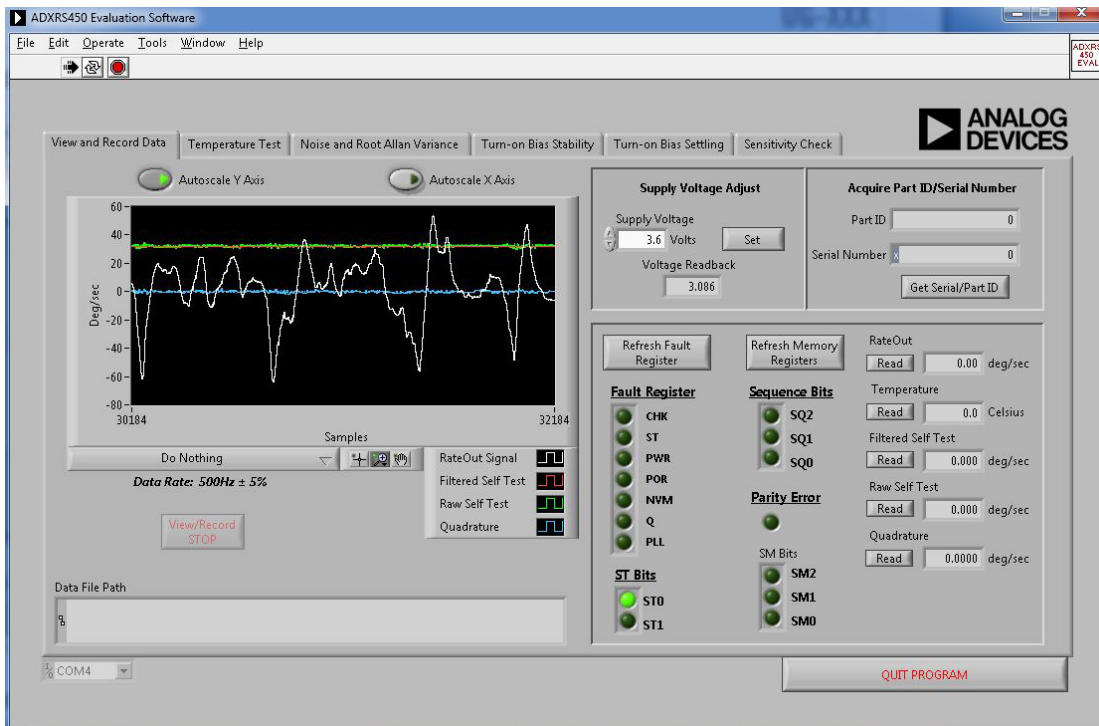

Figure 19. View and Record Data Panel

The **View and Record Data** panel is the primary panel for interacting with the device. The drop-down box, located beneath the graph, contains the following three options:

- **Do Nothing** (the default option)
- **View Gyro Signals**
- **Record Gyro Signals**

Clicking **View Gyro Signals** obtains the rateout signal, filtered self-test, raw self-test, and quadrature information from the device and plots all four signals simultaneously. As indicated by the GUI, the data rate at which this information is obtained is 500 Hz \pm 5%. The data rate is hardware controlled so that it remains constant regardless of the priority and processor load assigned to the software GUI by the operating system. For more information on the significance of the plotted signals, see the [ADXRS450](#) and [ADXRS453](#) data sheets.

Clicking **Record Gyro Signals** performs the same basic function as **View Gyro Signals**; however, it allows you to continuously stream the data to a .txt file. This is useful for recording the response of the part during short term events of less than ~2 minutes. This also ensures that the resulting data file is manageable across most data analysis software packages. You can perform the record functionality indefinitely.

Secondary information that is transmitted along with the plotted signals is graphically represented. This includes the fault

register, sequence bits, status bits, and sensor module bits.

This information is described in detail in the [ADXRS450](#) and [ADXRS453](#) data sheets. This information is also recorded along with the plotted signals when you select **Record Gyro Signals**.

Additional functionality on this panel includes the ability to change the supply voltage, read the device ID and serial number, read the individual memory registers, and perform offset adjustments to zero out any residual offset. These options encompass the majority of the functionality of the [ADXRS450/ADXRS453](#) gyroscope.

Adjusting the Supply Voltage

The [ADXRS450/ADXRS453](#) are designed to operate over the full voltage range of 3.3 V to 5 V (\pm 5%). The device is designed to offer equivalent performance regardless of the voltage level available in the application. The numeric control allows you to adjust the voltage to reflect the voltage level available in your application. Clicking the **Set** button in the **Supply Voltage Adjust** box updates the voltage supplied to the [ADXRS450/ADXRS453](#) satellite board. The **Voltage Readback** box accurately displays the satellite supply voltage, which may be slightly different from the value in the numeric control.

TEMPERATURE TEST PANEL



Figure 20. Temperature Test Panel

The **Temperature Test** panel is designed to let you easily perform long-term testing at a reduced bandwidth and data rate. The panel is specifically designed for temperature testing, with the on-board temperature sensor output plotted alongside the device rateout, filtered self-test, and quadrature. Each data point comprises an average of 250 samples, gathered at a 500 Hz data rate, resulting in a 2 Hz data rate from the device. You can view and record this information in much the same way as on the **View and Record** panel. Data is, again, streamed to a file to allow an indefinite length for data recording.

Before recording the data on this panel, you can adjust for null offset components. Note that any offset correction made to the [ADXRS450/ADXRS453](#) is stored in the device EEPROM indefinitely or until overwritten with a subsequent correction value. Any null offset corrections made on the **View and Record Data** panel persist throughout the evaluation GUI system even when the device is power cycled.

Supplemental information, including the fault register, sequence bits, and status bits, is graphically displayed and recorded in addition to the plotted information you choose to record.

NOISE AND ROOT ALLAN VARIANCE PANEL

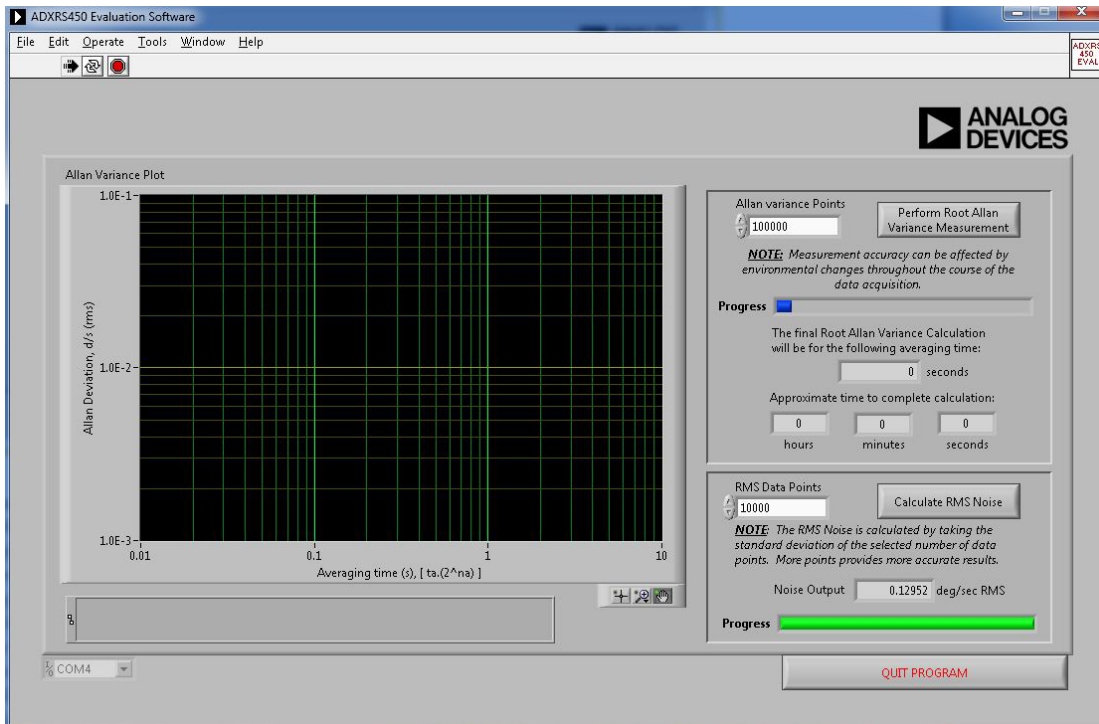

Figure 21. Noise and Root Allan Variance Panel

The software GUI includes the ability to calculate and plot the root Allan variance (RAV) and the rms noise of the [ADXRS450/ADXRS453](#).

Root Allan variance can be approximately described as the variation of successive long-term averages of the null output of the [ADXRS450/ADXRS453](#). This is usually reported in units of degrees per hour and indicates the long-term bias stability of a gyroscope. To generate an accurate root Allan variance plot, it is recommended that this test be run (at least) overnight, during which time care should be taken to ensure that the device is in a temperature-stable, and disturbance-free environment. Any

rotational rate input into the gyroscope can greatly degrade the validity of the resulting RAV plot.

Determining the rms noise of the [ADXRS450/ADXRS453](#) can be done on this same panel. The evaluation GUI calculates the rms noise by taking the standard deviation of the specified number of points, which is roughly equivalent to the 1-sigma peak-to-peak noise value. These data points are obtained at a 500 Hz data rate. It is recommended that you perform this test with at least 16,000 data points to obtain accurate results. Fewer data points can be used, but the reported rms noise is then subject to higher variability.

TURN-ON BIAS STABILITY PANEL

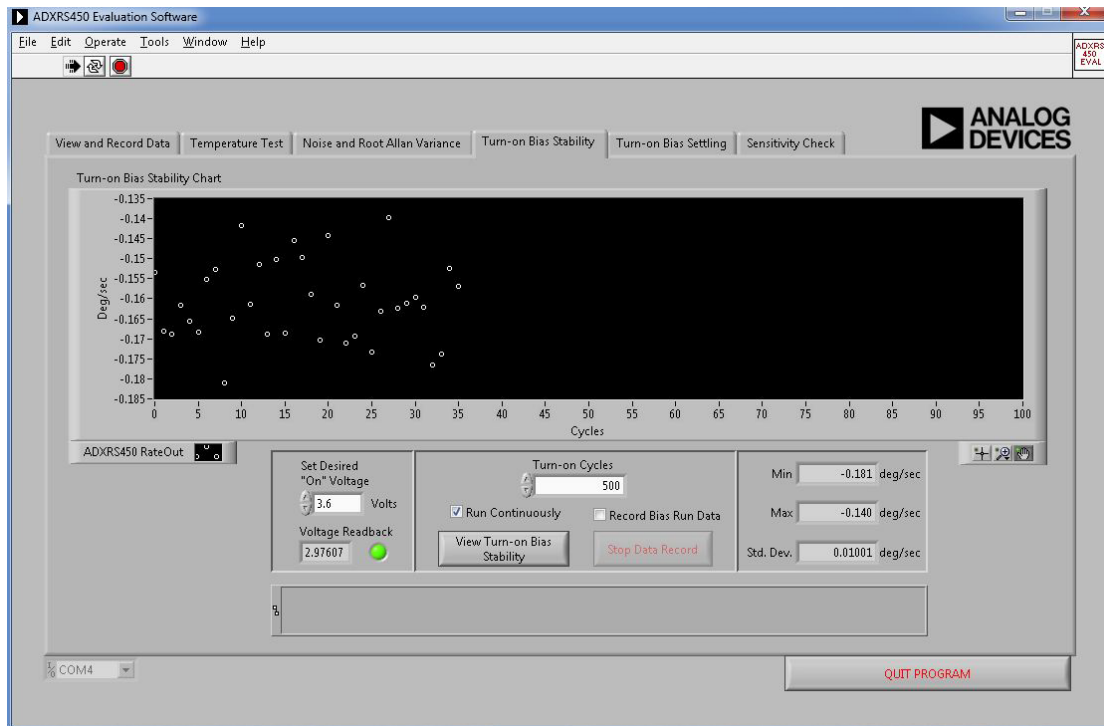

Figure 22. Turn-On Bias Stability Panel

Another key performance characteristic of gyroscopes is their turn-on-to-turn-on bias stability, which determines the range of expected offset values between each power cycle that can be factored into the development of application specific algorithms.

The **Turn-on Bias Stability** panel allows you to adjust the supply voltage for this test to match the intended application voltage. To record the data from this panel, ensure that the **Record Bias Run Data** box is checked before clicking the **View Turn-on Bias Stability** button. You are then prompted to enter

a file name for the data upon completion of the specified number of turn-on cycles or upon clicking the **Stop Data Record** button. While the test is running, the **Min**, **Max**, and **Std. Dev.** boxes are updated upon the completion of each power cycle.

It is recommended that this test be run for several hours and in a temperature-stable and disturbance-free environment. Any rotational motion applied to the gyro corrupts the results of this experiment.

TURN-ON BIAS SETTling PANEL

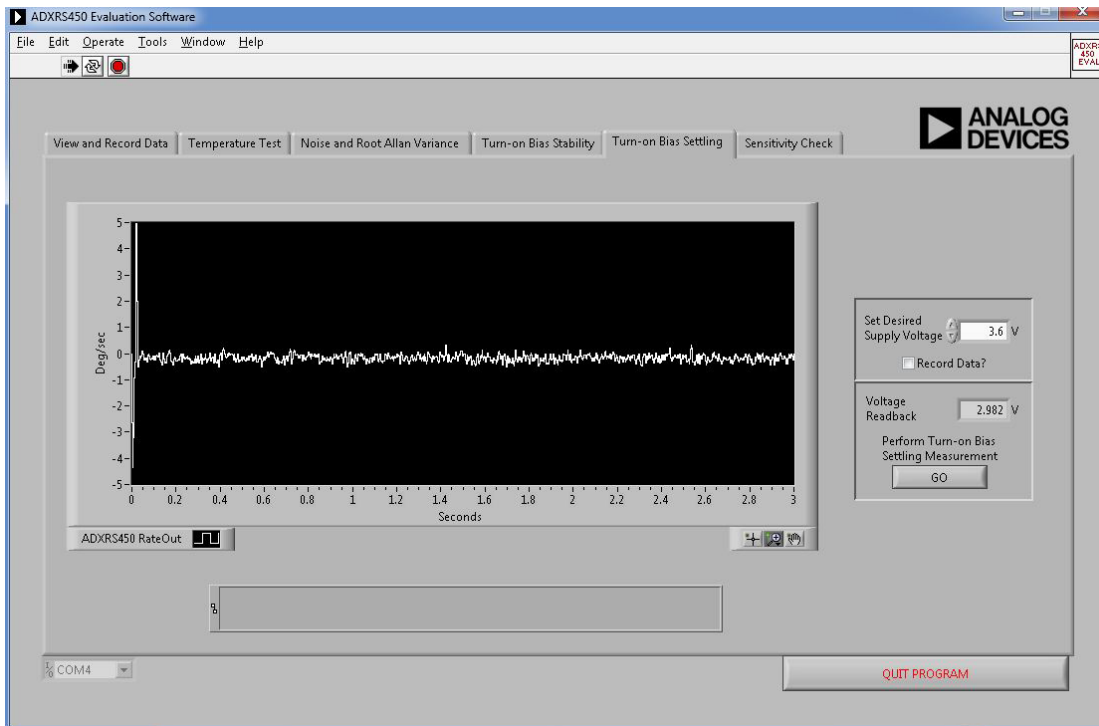

Figure 23. Turn-On Bias Settling

In addition to the bias stability from one power cycle to the next, it is important to understand the device behavior at the moment power is applied to the device. It is recommended that you wait a turn-on time of 100 ms (typical) before attempting to obtain accurate rate data. However, for cases where it is not possible to control the communications timings to comply with this recommendation, this panel enables observation of the turn-on behavior of the ADXRS450/ADXRS453 for incorporation into your system's algorithms. For this test panel,

the first SPI message is typically received from the device within 20 ms after the ISEB supplies power to the satellite board.

Additionally, if the device is rotated at a constant rate while power is applied, the **Turn-on Bias Settling** panel (see Figure 23) verifies that the conditions defined for the turn-on time are achieved; that is, after 100 ms (typical), the device output is within 1% or $\frac{1}{2}^\circ/\text{sec}$ of the applied rotational rate, whichever is higher.

SENSITIVITY CHECK PANEL

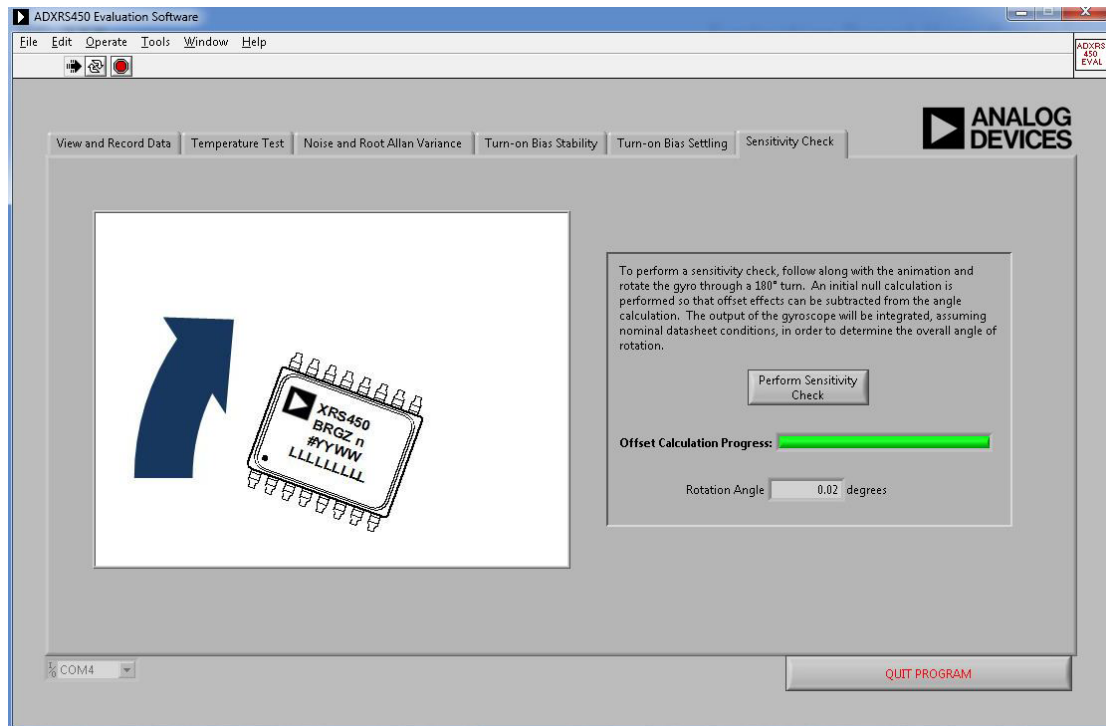

Figure 24. Sensitivity Check Panel

The last panel (see Figure 24) provides a method for checking the approximate sensitivity of a given device. The data sheet specification for sensitivity is $80 \pm 3\%$ LSBs/ $^{\circ}$ /sec. This panel is designed to use the nominal sensitivity to calculate the angle of rotation experienced by the satellite board. If you have access to a firmly rooted straight edge, you can use the **Sensitivity Check** panel as follows:

1. Place a flat edge of the satellite board firmly against the stable straight edge.
2. Click the **Perform Sensitivity Check** button. Do not rotate the satellite board until instructed by the evaluation GUI. The software must perform an initial calibration step to accurately calculate the angle of rotation.
3. When prompted, slowly rotate the satellite board through 180° (90° can also be used). Because the satellite board is approximately square, as each adjacent side is brought flush with the straight edge, 90° of rotation is experienced. After the gyro graphic in the GUI rotates through 180° , the measurement stops.
4. If you finish rotating the device before completion of the measurement, firmly hold the satellite board against the straight edge to ensure that no additional rotation is applied to the device.

At the completion of the measurement, the angle through which the satellite board was rotated should appear in the GUI. This measurement should be considered approximate because error sources incurred during the angle integration can alter the results.

ALTERNATE EXTERNAL HIGH VOLTAGE SUPPLY

As shown in Figure 25, the default jumper positions configure the part to use an on-board boost converter to generate a high voltage (approximately 24 V) input signal. This boost converter is supported through circuitry internal to the [ADXRS450/ADXRS453](#) and requires an external inductor and a diode for proper operation. See the [ADXRS450](#) and [ADXRS453](#) data sheets for a full description of the boost converter operation.

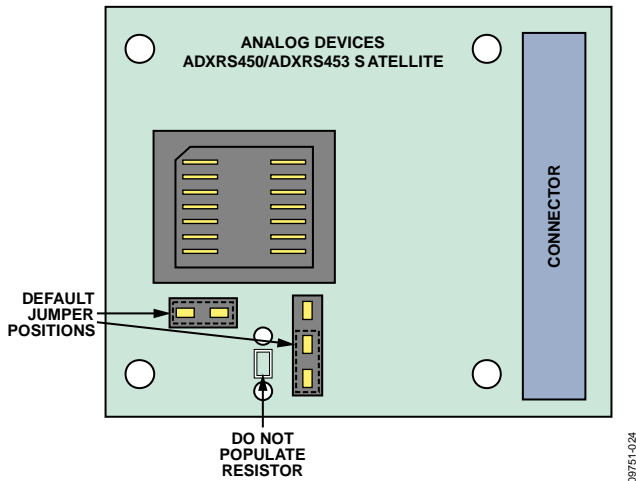

Figure 25. Default Jumper Configuration

If the end application has an external high voltage supply available, and you want to omit the inductor and diode, you can modify the satellite board to accept this supply. Figure 26 shows the required jumper configuration when using an external high voltage supply. Additionally, a footprint for a through-hole resistor has been included. This resistor must be populated such that, when combined with the high voltage supply, the proper current is sourced to the [ADXRS450/ADXRS453](#). The supply requirements are described in detail in the [ADXRS450](#) and [ADXRS453](#) data sheets. The main requirement for the external

high voltage supply is that 0.1 mA to 1 mA of current be supplied to the device. The nominal internal voltage is 22.5 V.

As an example, assume that a 30 V supply is available in the end application. Then 22.5 V (typical) is required internally, and 30 V is available externally. For this condition, 7.5 V is dropped across the external resistor. To ensure that between 0.1 mA and 1 mA of current is sourced, a 12 k Ω resistor can be chosen. This sources 0.625 mA to the [ADXRS450/ADXRS453](#).

You can then test the satellite board in exactly the same way as described throughout this user guide and be able to verify that your external supply meets the requirements of the [ADXRS450/ADXRS453](#), accounting for supply tolerances and temperature effects.

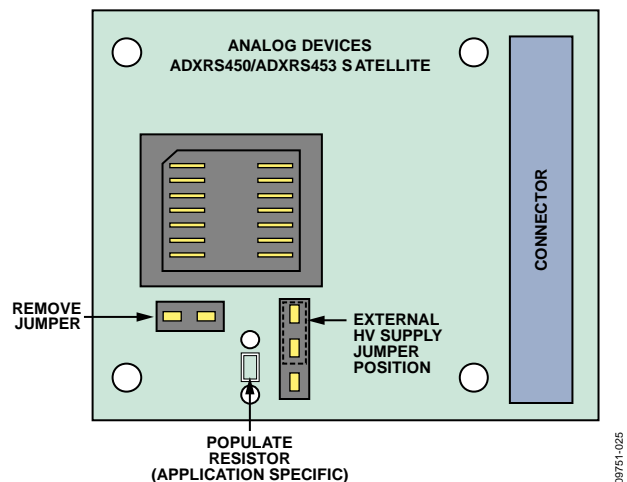

Figure 26. Jumper Configuration for External High Voltage Supply

HEADER PINOUT

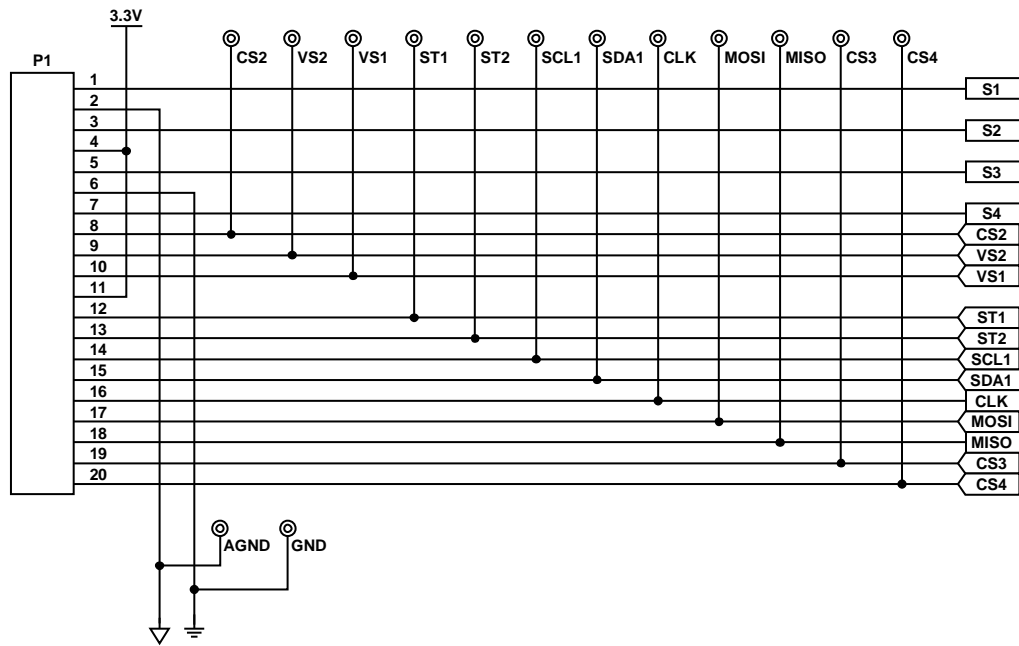

Figure 27. ISEB 20-Pin Header Pinout

08751-013

NOTES

NOTES

NOTES

**ESD Caution**

ESD (electrostatic discharge) sensitive device. Charged devices and circuit boards can discharge without detection. Although this product features patented or proprietary protection circuitry, damage may occur on devices subjected to high energy ESD. Therefore, proper ESD precautions should be taken to avoid performance degradation or loss of functionality.

Legal Terms and Conditions

By using the evaluation board discussed herein (together with any tools, components documentation or support materials, the "Evaluation Board"), you are agreeing to be bound by the terms and conditions set forth below ("Agreement") unless you have purchased the Evaluation Board, in which case the Analog Devices Standard Terms and Conditions of Sale shall govern. Do not use the Evaluation Board until you have read and agreed to the Agreement. Your use of the Evaluation Board shall signify your acceptance of the Agreement. This Agreement is made by and between you ("Customer") and Analog Devices, Inc. ("ADI"), with its principal place of business at One Technology Way, Norwood, MA 02062, USA. Subject to the terms and conditions of the Agreement, ADI hereby grants to Customer a free, limited, personal, temporary, non-exclusive, non-sublicensable, non-transferable license to use the Evaluation Board FOR EVALUATION PURPOSES ONLY. Customer understands and agrees that the Evaluation Board is provided for the sole and exclusive purpose referenced above, and agrees not to use the Evaluation Board for any other purpose. Furthermore, the license granted is expressly made subject to the following additional limitations: Customer shall not (i) rent, lease, display, sell, transfer, assign, sublicense, or distribute the Evaluation Board; and (ii) permit any Third Party to access the Evaluation Board. As used herein, the term "Third Party" includes any entity other than ADI, Customer, their employees, affiliates and in-house consultants. The Evaluation Board is NOT sold to Customer; all rights not expressly granted herein, including ownership of the Evaluation Board, are reserved by ADI. CONFIDENTIALITY. This Agreement and the Evaluation Board shall all be considered the confidential and proprietary information of ADI. Customer may not disclose or transfer any portion of the Evaluation Board to any other party for any reason. Upon discontinuation of use of the Evaluation Board or termination of this Agreement, Customer agrees to promptly return the Evaluation Board to ADI. ADDITIONAL RESTRICTIONS. Customer may not disassemble, decompile or reverse engineer chips on the Evaluation Board. Customer shall inform ADI of any occurred damages or any modifications or alterations it makes to the Evaluation Board, including but not limited to soldering or any other activity that affects the material content of the Evaluation Board. Modifications to the Evaluation Board must comply with applicable law, including but not limited to the RoHS Directive. TERMINATION. ADI may terminate this Agreement at any time upon giving written notice to Customer. Customer agrees to return to ADI the Evaluation Board at that time. LIMITATION OF LIABILITY. THE EVALUATION BOARD PROVIDED HEREUNDER IS PROVIDED "AS IS" AND ADI MAKES NO WARRANTIES OR REPRESENTATIONS OF ANY KIND WITH RESPECT TO IT. ADI SPECIFICALLY DISCLAIMS ANY REPRESENTATIONS, ENDORSEMENTS, GUARANTEES, OR WARRANTIES, EXPRESS OR IMPLIED, RELATED TO THE EVALUATION BOARD INCLUDING, BUT NOT LIMITED TO, THE IMPLIED WARRANTY OF MERCHANTABILITY, TITLE, FITNESS FOR A PARTICULAR PURPOSE OR NON-INFRINGEMENT OF INTELLECTUAL PROPERTY RIGHTS. IN NO EVENT WILL ADI AND ITS LICENSORS BE LIABLE FOR ANY INCIDENTAL, SPECIAL, INDIRECT, OR CONSEQUENTIAL DAMAGES RESULTING FROM CUSTOMER'S POSSESSION OR USE OF THE EVALUATION BOARD, INCLUDING BUT NOT LIMITED TO LOST PROFITS, DELAY COSTS, LABOR COSTS OR LOSS OF GOODWILL. ADI'S TOTAL LIABILITY FROM ANY AND ALL CAUSES SHALL BE LIMITED TO THE AMOUNT OF ONE HUNDRED US DOLLARS (\$100,000). EXPORT. Customer agrees that it will not directly or indirectly export the Evaluation Board to another country, and that it will comply with all applicable United States federal laws and regulations relating to exports. GOVERNING LAW. This Agreement shall be governed by and construed in accordance with the substantive laws of the Commonwealth of Massachusetts (excluding conflict of law rules). Any legal action regarding this Agreement will be heard in the state or federal courts having jurisdiction in Suffolk County, Massachusetts, and Customer hereby submits to the personal jurisdiction and venue of such courts. The United Nations Convention on Contracts for the International Sale of Goods shall not apply to this Agreement and is expressly disclaimed.