

**YELLOW GMA 2885C GMC 2885C
HER GMA 2985C GMC 2985C
GREEN GMA 2485C GMC 2485C
BICOLOR RED/GREEN GMA 2685C**

PACKAGE DIMENSIONS

A. GMX2X85C

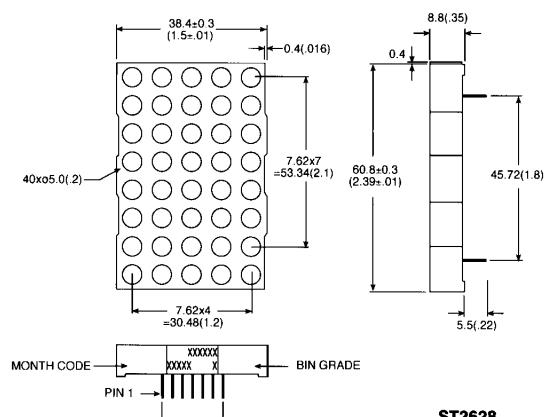

ST2628

B. GMA2685C

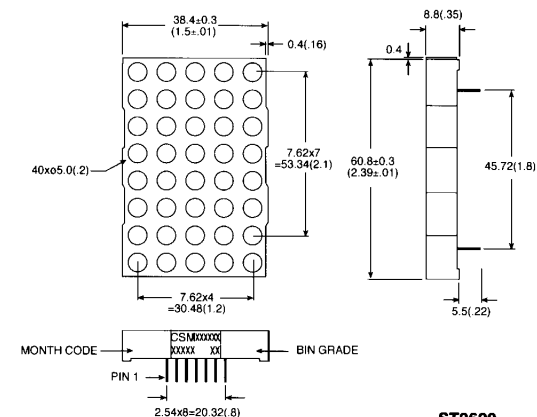

ST2629

DESCRIPTION

These are 5×8 dot matrix displays with large emitting area (0.2" diameter) LED sources. The GMX2X85C series are single color displays with the exception of GMA2685C which is a bicolor of red/green displays.

All displays have gray face and white dot color. Other face or dot colors are available with minimum requirement.

The X in GMX denotes row anode or row cathode.

FEATURES

- 2.3" (58.4 mm) character height
- Low power requirement
- High contrast & brightness
- Wide viewing angle 130°
- 5 × 8 array with X-Y select
- Compatible with USASCII and EBCDIC codes
- X-Y stackable
- Choice of two matrix orientation anode or cathode column
- Easy mounting on PCB
- Categorized for luminous intensity
- Single color displays have the choice of 3 bright colors — yellow/orange/green
- Multicolor color displays are applicable to 3 bright colors — greens, orange (HER) and yellow (green and HER mixed)

NOTES:

1. ALL PINS ARE 90.5 (.02).
2. DIMENSIONS IN MILLIMETERS (INCH), TOLERANCE IS ±0.25 (.01) UNLESS OTHERWISE NOTED.



**2.3" 5 × 8
DOT MATRIX DISPLAYS**

ABSOLUTE MAXIMUM RATING (T _A = 25°C unless otherwise specified)				
PARAMETER	YELLOW	HER	GREEN	UNITS
Power dissipation per dot/color	60	70	75	mW
Peak forward current per dot/color (duty cycle 1/10, 10KHz)	80	100	100	mA
Continuous I _F per dot/color	20	25	25	mA
Reverse voltage V _R per dot/color	5	5	5	V
Operating and storage temperature range	-25°C to +85°C			
Soldering time at 260°C (1/16 inch below seating plane)	3 sec			

MODEL NUMBERS							
		PART NO.			DESCRIPTION	PACKAGE DIMENSION	INTERNAL CIRCUIT DIAGRAM
YELLOW	HER	GREEN	MULTI-COLOR				
GMC2885C	GMC2985C	GMC2485C		Anode column, cathode row	A	A	
GMA2885C	GMA2985C	GMA2485C		Cathode column, anode row	A	B	
			GMA2685C	Cathode column, anode row	B	C	

ELECTRICAL/OPTICAL CHARACTERISTICS ($T_A = 25^\circ\text{C}$ Unless otherwise specified)					
GMX 2485C					
PARAMETER	MIN.	TYP.	MAX.	UNITS	TEST CONDITIONS
Average luminous intensity		3000		μcd	$I_F = 20 \text{ mA}$
Peak emission wavelength		565		nm	$I_F = 20 \text{ mA}$
Spectral line half-width		30		nm	$I_F = 20 \text{ mA}$
Forward voltage, any dot		2.1	2.8	V	$I_F = 20 \text{ mA}$
Reverse voltage, any dot			100	μA	$V_R = 5 \text{ V}$

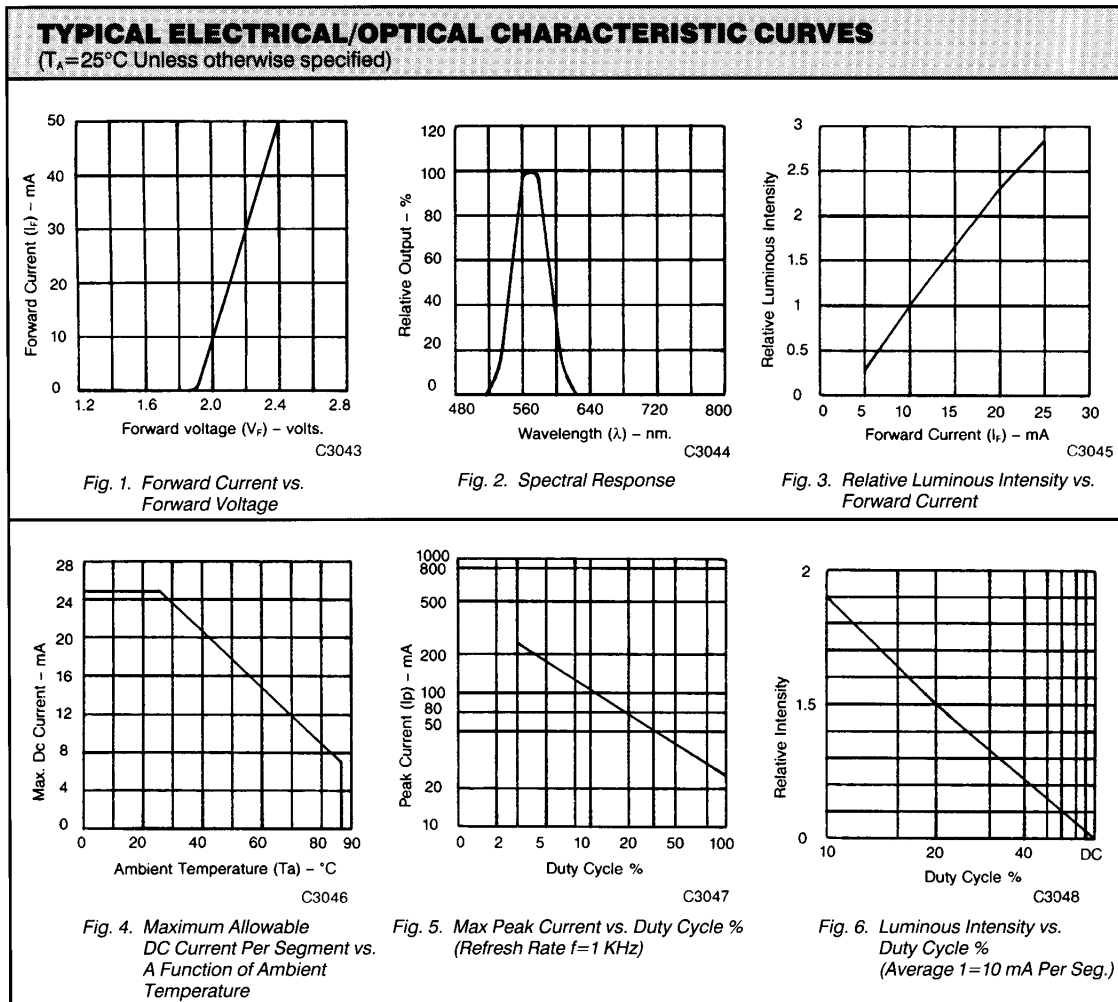

ELECTRICAL/OPTICAL CHARACTERISTICS ($T_A = 25^\circ\text{C}$ Unless otherwise specified)					
GMX 2985C					
PARAMETER	MIN.	TYP.	MAX.	UNITS	TEST CONDITIONS
Average luminous intensity		3000		μcd	$I_F = 20\text{ mA}$
Peak emission wavelength		635		nm	$I_F = 20\text{ mA}$
Spectral line half-width		30		nm	$I_F = 20\text{ mA}$
Forward voltage, any dot		2.1	2.8	V	$I_F = 20\text{ mA}$
Reverse voltage, any dot			100	μA	$V_R = 5\text{ V}$

TYPICAL ELECTRICAL/OPTICAL CHARACTERISTIC CURVES
($T_A = 25^\circ\text{C}$ Unless otherwise specified)

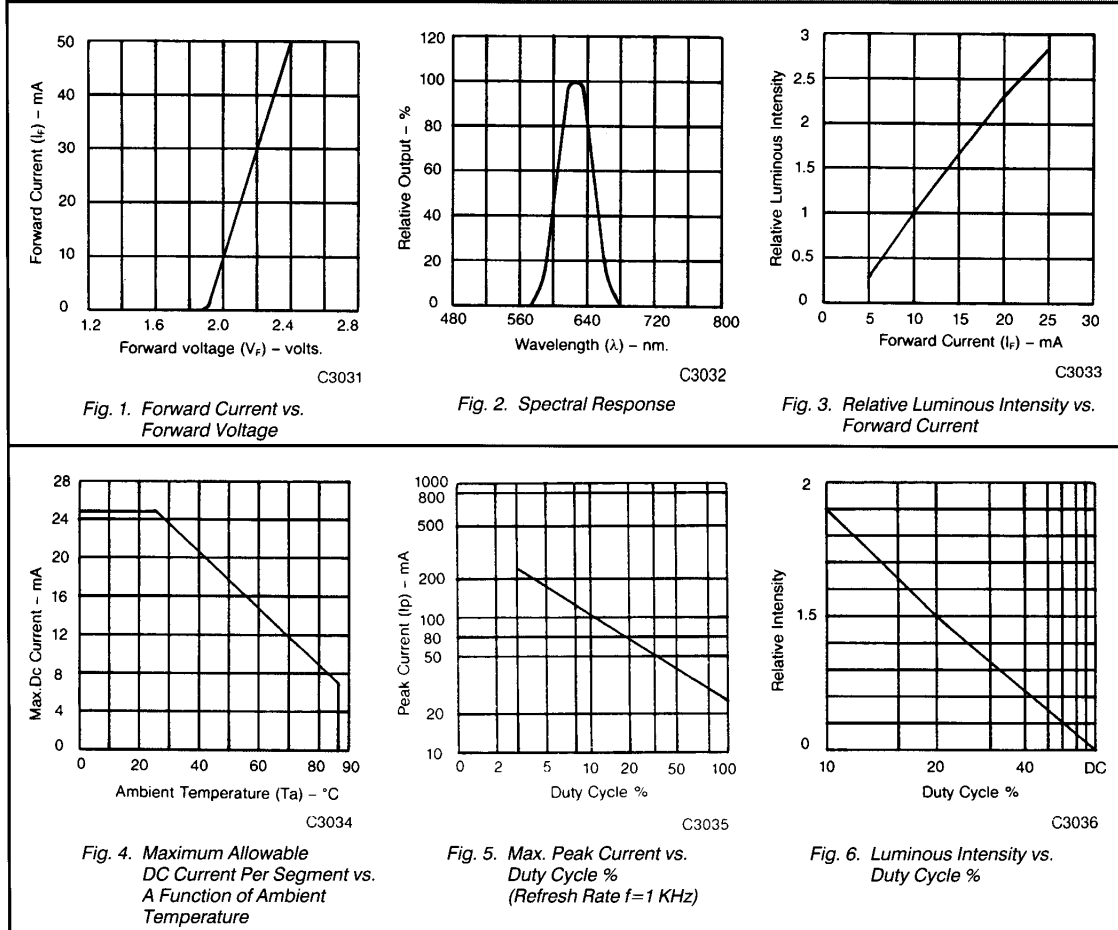

ELECTRICAL/OPTICAL CHARACTERISTICS ($T_A = 25^\circ\text{C}$ Unless otherwise specified)					
GMX 2885C					
PARAMETER	MIN.	TYP.	MAX.	UNITS	TEST CONDITIONS
Average luminous intensity		3000		μcd	$I_f = 20 \text{ mA}$
Peak emission wavelength		585		nm	$I_f = 20 \text{ mA}$
Spectral line half-width		30		nm	$I_f = 20 \text{ mA}$
Forward voltage, any dot		2.1	2.8	V	$I_f = 20 \text{ mA}$
Reverse voltage, any dot			100	μA	$V_R = 5 \text{ V}$

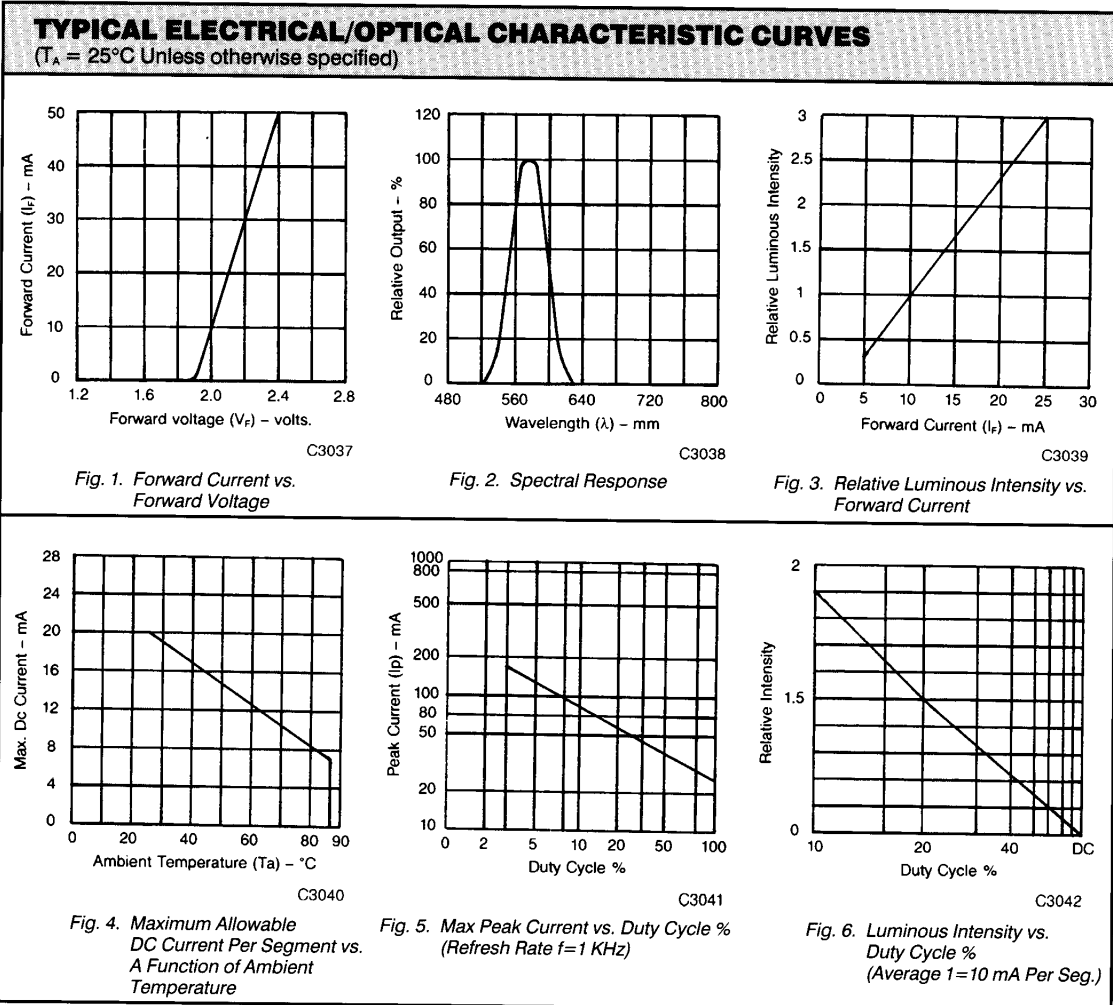



**2.3" 5 × 8
DOT MATRIX DISPLAYS**

PIN CONNECTION			
PIN NO.	GMC2X85C	GMA2X85C	GMC2685C
1	Cathode row 6	Anode row 6	Cathode column 1 green
2	Cathode row 8	Anode row 8	Cathode column 2 green
3	Anode column 2	Cathode column 2	Cathode column 2 HER
4	Anode column 3	Cathode column 3	Cathode column 3 HER
5	Cathode row 5	Anode row 5	Anode row 6
6	Anode column 5	Cathode column 5	Anode row 7
7	Cathode row 7	Anode row 7	Cathode column 4 HER
8	Cathode row 3	Anode row 3	Anode row 5
9	Cathode row 1	Anode row 1	Anode row 8
10	Anode column 4	Cathode column 4	Cathode column 5 green
11	Anode column 3	Cathode column 3	Cathode column 5 HER
12	Cathode row 4	Anode row 4	Cathode column 4 green
13	Anode column 1	Cathode column 1	Anode column 3 green
14	Cathode row 2	Anode row 2	Anode row 4
15			Anode row 2
15			Anode row 1
15			Anode row 3
15			Cathode column 1 HER

INTERNAL CIRCUIT DIAGRAM

A. GMC2X85C

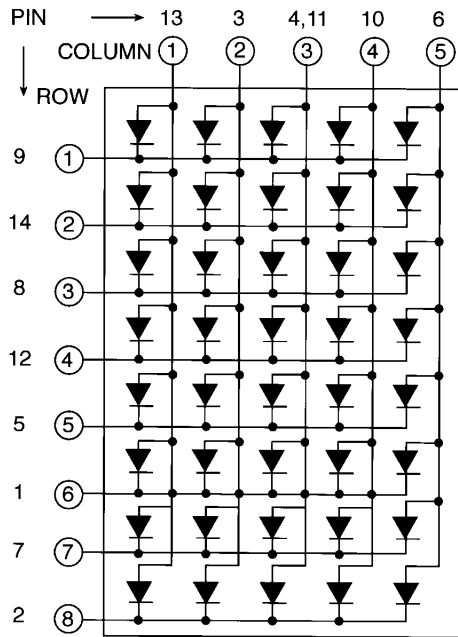

B. GMA2X85C

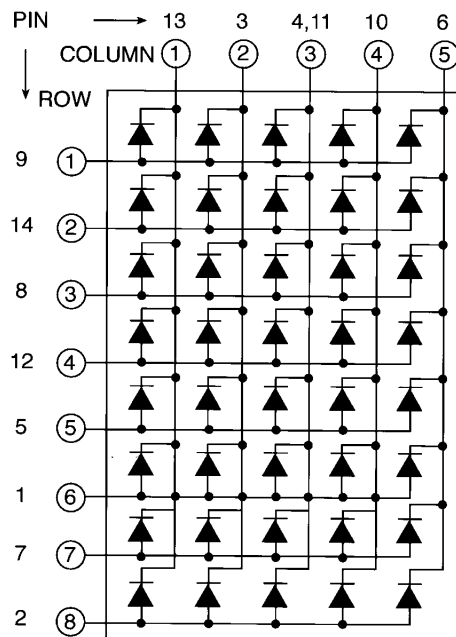

C. GMA2685C

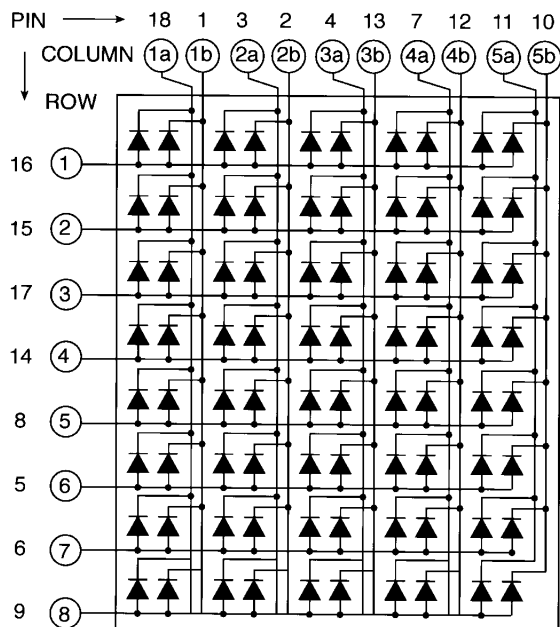



2.3" 5 X 8 DOT MATRIX DISPLAYS

DISCLAIMER

FAIRCHILD SEMICONDUCTOR RESERVES THE RIGHT TO MAKE CHANGES WITHOUT FURTHER NOTICE TO ANY PRODUCTS HEREIN TO IMPROVE RELIABILITY, FUNCTION OR DESIGN. FAIRCHILD DOES NOT ASSUME ANY LIABILITY ARISING OUT OF THE APPLICATION OR USE OF ANY PRODUCT OR CIRCUIT DESCRIBED HEREIN; NEITHER DOES IT CONVEY ANY LICENSE UNDER ITS PATENT RIGHTS, NOR THE RIGHTS OF OTHERS.

LIFE SUPPORT POLICY

FAIRCHILD'S PRODUCTS ARE NOT AUTHORIZED FOR USE AS CRITICAL COMPONENTS IN LIFE SUPPORT DEVICES OR SYSTEMS WITHOUT THE EXPRESS WRITTEN APPROVAL OF THE PRESIDENT OF FAIRCHILD SEMICONDUCTOR CORPORATION. As used herein:

1. Life support devices or systems are devices or systems which, (a) are intended for surgical implant into the body, or (b) support or sustain life, and (c) whose failure to perform when properly used in accordance with instructions for use provided in the labeling, can be reasonably expected to result in a significant injury of the user.
2. A critical component in any component of a life support device or system whose failure to perform can be reasonably expected to cause the failure of the life support device or system, or to affect its safety or effectiveness.