

## DESCRIPTION

Demonstration circuit DC437 is a low noise negative micropower voltage regulator using the LT1964 low dropout linear regulator, which comes in a tiny 5-Pin SOT-23 package. The DC437 has an input voltage range from  $-2.3\text{V}$  to  $-20\text{V}$ , and is capable of delivering 200mA max. With the small size of the LT1964, plus its ability to maintain a stable output (no oscillations) with ceramic output capacitors, the DC437 voltage regulator is ideally suited for hand-held applications, such as cellular phones or PDAs.

## QUICK START PROCEDURE

The DC437 demonstration board is easy to set up to evaluate the performance of the LT1964 negative micropower LDO regulator.

Refer to Figure 1 for the connection diagram and follow the procedures below:

**NOTE** Be careful when you connect the test equipment to the board. Remember, ground (Gnd) is the most positive potential on the board, and Vin is the most negative potential. Thus, current flows from Gnd to Vout and Vin, and from Vout to Vin. Set up the circuit appropriately.

### EVALUATING THE LT1964ES5-BYP (UPPER CIRCUIT)

1. Connect the input power supply to the Vin and GND terminals on the left-side of the board.
2. Connect the load between the Vout and GND terminals on the right-side of the board.
3. Select the desired output voltage using JP1. To select an output voltage of  $-1.22\text{V}$ , insert the jumper into the lower position. Inserting the jumper into the upper position forces the output to  $-5\text{V}$ . The upper

There are two circuits on this demo board. When looking at the board right-side up (the title is at the top of the board):

- the upper circuit is a regulator that uses the LT1964ES5-BYP
- the lower circuit is a regulator that uses the LT1964ES5-SD.

Gerber files for this circuit are available. Call the LTC Factory.

position also allows a user selectable output voltage with the installation of R3.

### EVALUATING THE LT1964ES5-SD (LOWER CIRCUIT)

1. Connect the input power supply to the Vin and GND terminals on the left-side of the board.
2. Connect the load between the Vout and GND terminals on the right-side of the board.
3. To start the circuit, insert a jumper into the upper position of JP2.
4. Select the desired output voltage using JP3. To select an output voltage of  $-1.22\text{V}$ , insert the jumper into the lower position. Inserting the jumper into the upper position forces the output to  $-5\text{V}$ . The upper position also allows a user selectable output voltage with the installation of R6.
5. To shut down the circuit, connect the SHDN pin to ground by inserting a jumper into the lower position of JP2. Do not leave this pin floating.

# DEMO BOARD QUICK START GUIDE DC437

## LOW DROPOUT LINEAR REGULATOR

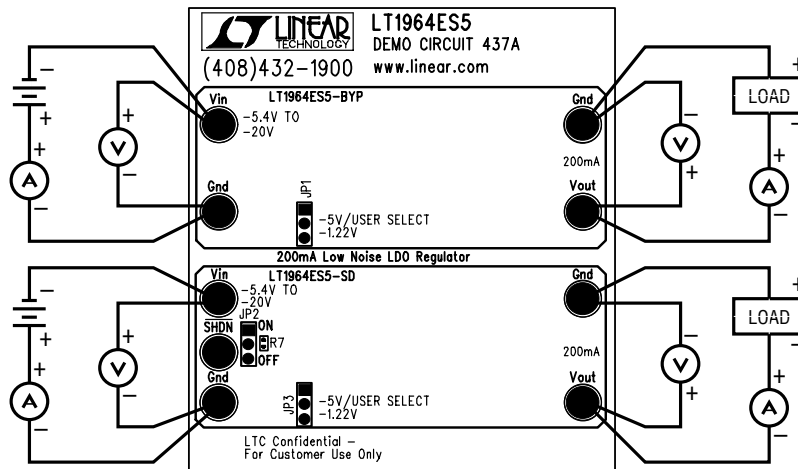
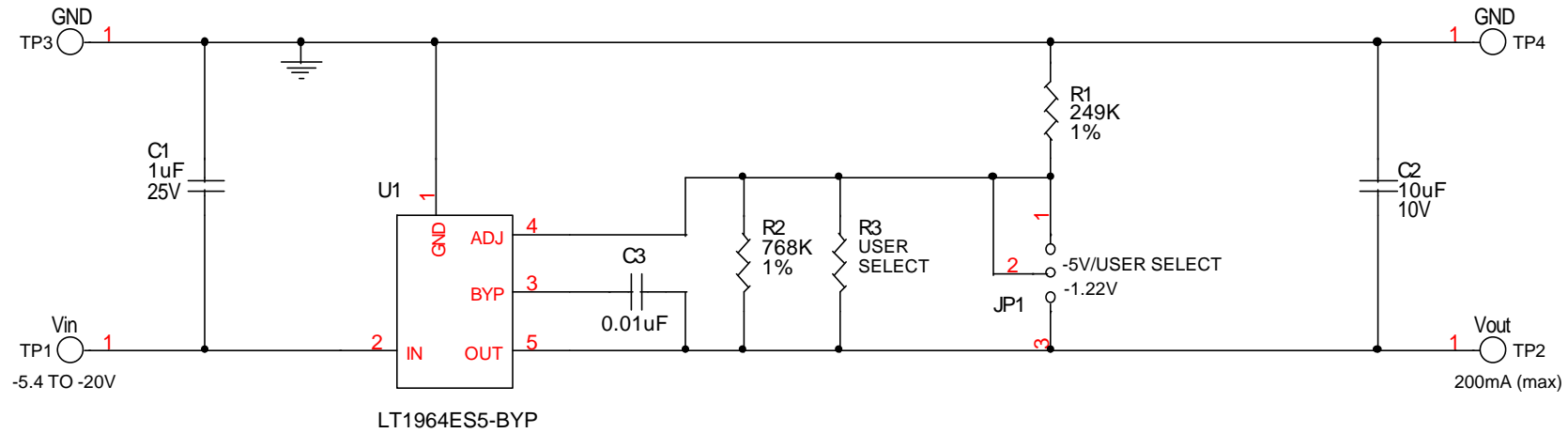
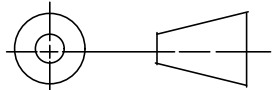



Figure 1. Proper Measurement Equipment Setup



REVISION HISTORY				
ECO	REV	DESCRIPTION	DATE	APPROVED
0	2	PROTO	09-19-01	>

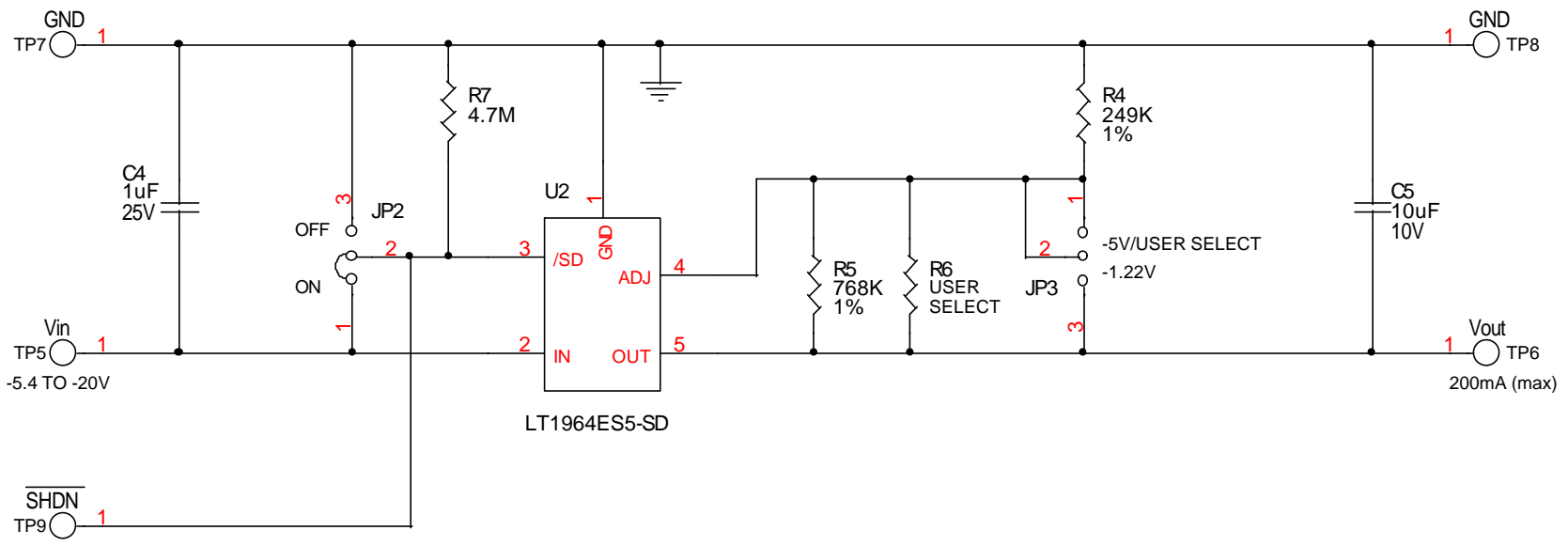

UNLESS OTHERWISE SPECIFIED DIMENSIONS ARE IN INCHES TOLERANCE ON ANGLE --- 2 PLACES --- 3 PLACES --- INTERPRET DIM AND TOL PER ASME Y14.5M -1994 THIRD ANGLE PROJECTION 	CONTRACT NO.		 1630 McCarthy Blvd Milpitas, CA 95035 Phone: (408)432-1900 Fax: (408)434-0507		
	APPROVALS	DATE			
	DRAWN MEI	06-05-01	TITLE		
	CHECKED		LT1964 NEGATIVE LOW NOISE LDO REGULATOR 200mA		
APPROVED		SIZE	CAGE CODE	DWG NO	
ENGINEER		A		DC437A	
DESIGNER		SCALE: NONE		REV	
		FILENAME: 437A-2.PCB		2	
DO NOT SCALE DRAWING	Wednesday, September 26, 2001	SHEET 1 OF 2			

REVISION HISTORY				
ECO	REV	DESCRIPTION	DATE	APPROVED
0	2	PROTO	09-19-01	>

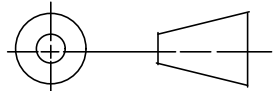

UNLESS OTHERWISE SPECIFIED DIMENSIONS ARE IN INCHES TOLERANCE ON ANGLE --- 2 PLACES --- 3 PLACES --- INTERPRET DIM AND TOL PER ASME Y14.5M -1994 THIRD ANGLE PROJECTION 	CONTRACT NO.		 1630 McCarthy Blvd Milpitas, CA 95035 Phone: (408)432-1900 Fax: (408)434-0507		
	APPROVALS	DATE			
	DRAWN MEI	06-13-01	TITLE <b>LT1964 NEGATIVE LOW NOISE LDO          REGULATOR 200mA</b>		
	CHECKED		SIZE	CAGE CODE	DWG NO
APPROVED		A		DC437A-2	REV 2
ENGINEER		SCALE: NONE			SHEET 2 OF 2
DESIGNER		FILENAME: 437A-2.PCB			
DO NOT SCALE DRAWING	Wednesday, September 26, 2001				

<b>Item</b>	<b>Qty</b>	<b>Ref</b>	<b>Desc</b>	<b>Part Number</b>
1	2	C1,C4	CAP,X7R 1uF 25V 20% 1206	TAIYO YUDEN TMK316BJ105ML
2	2	C2,C5	CAP,X7R 10uF 10V 20% 1210	TAIYO YUDEN LMK325BJ106MN-T
3	1	C3	CAP,X7R 0.01uF 16V 5% 0402	AVX 0402YC103JAT2A
4	3	JP1,JP2,JP3	HEADER,3 PINS 2mm	COMM 2802S-03G2
5	2	R1,R4	RES,249K OHM 1% 1/16W 0402	AAC CR05-2493FM
6	2	R2,R5	RES,768K OHM 1% 1/16W 0603	AAC CR16-7683FM
7	0	R3,R6 (OPT)	DO NOT STUFF	OPTION
8	1	R7	RES,4.7MEG OHM 5% 1/16W 0402	AAC CR05-474JM
9	9	TP1-TP9	TURRET	MILL MAX2501-2
10	1	U1	IC,LT1964ES5-BYP LOW NOISE NEGATIVE REGULATOR	LT1964ES5-BYP
11	1	U2	IC,LT1964ES5-SD LOW NOISE NEGATIVE REGULATOR	LT1964ES5-SD