



GW-7238D

Quick Start

Nov. 2011 Version 1.0

Package checklist

The package includes the following items:

- One GW-7238D hardware module
- One Quick Start
- One software utility CD
- One screw driver
- One RS-232 cable (CA-0910)

Note:

If any of these items are missed or damaged, contact the local distributors for more information. Save the shipping materials and cartons in case you want to ship in the future.



● Appearance and pin assignments

Table 1: COM Connector Pin Assignment

| Pin No. | Name | Description |
|---------|--------|---|
| 1 | CTS1 | CTS pin of COM1 (RS-232) |
| 2 | RTS1 | RTS pin of COM1 (RS-232) |
| 3 | RXD1 | RXD pin of COM1 (RS-232) |
| 4 | TXD1 | TXD pin of COM1 (RS-232) |
| 5 | INIT* | Initial pin for enable/disable AUTOEXEC.BAT |
| 6 | (Y)D2+ | Data+ pin of COM2 (RS-485) |
| 7 | (G)D2- | Data- pin of COM2 (RS-485) |
| 8 | (R)VS+ | V+ of power supply |
| 9 | (B)GND | GND of power supply |

Table 2: CAN bus Connector Pin Assignment

| Pin No. | Name | Description |
|---------|-------|--------------------------------|
| 1 | N/A | Not Connected |
| 2 | CAN_L | CAN_L bus line (dominant low) |
| 3 | N/A | Not Connected |
| 4 | CAN_H | CAN_H bus line (dominant high) |
| 5 | N/A | Not Connected |

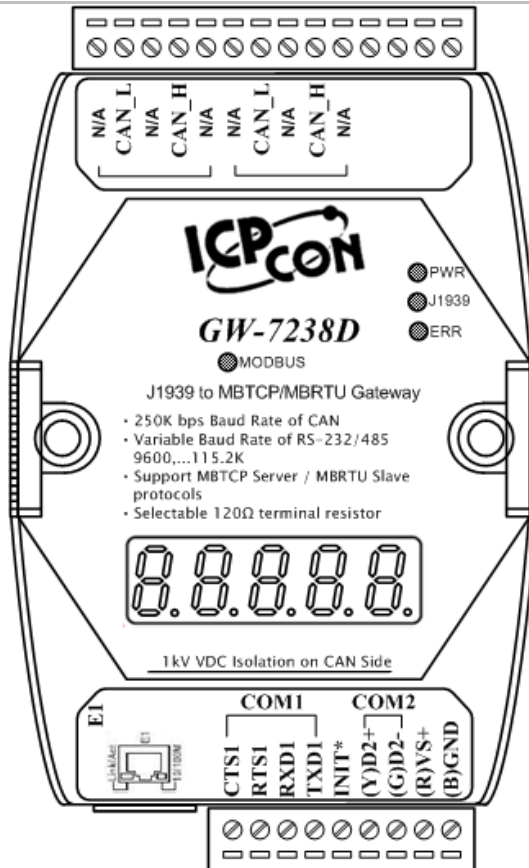

Figure 1: Appearance of the GW-7238D

● LED Indication

Table 3: LED indication of the GW-7238D

| LED Name | GW-7238D Status | LED Status |
|------------|---------------------|------------|
| PWR LED | Firmware is running | On |
| | Power Failure | Off |
| ERR LED | No Error | Off |
| | Error | Blink |
| J1939 LED | Transmission | Blink |
| | Bus Idle | Off |
| MODBUS LED | Transmission | Blink |
| | Bus Idle | On or Off |

● 5-digits 7-segment LED Displays

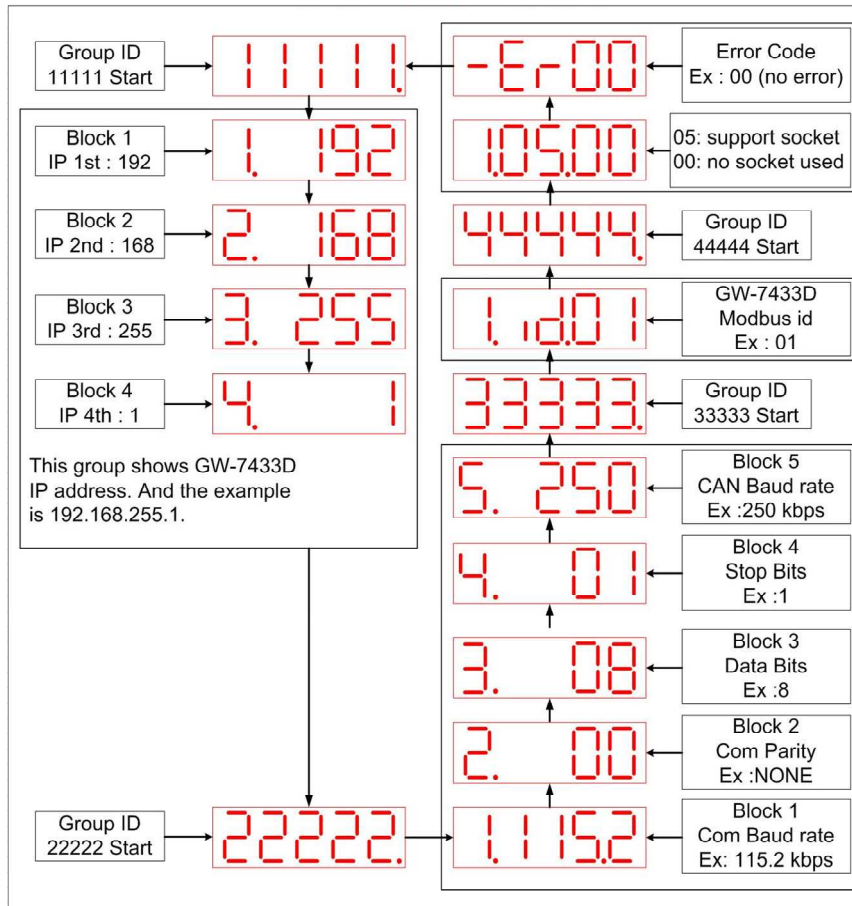

Figure 2: The meaning of the 7-segment LED

● Installation

If users want to start the GW-7238D normally, it needs to follow these steps to install the GW-7238D below:

Step1: Check GW-7238D Firmware Mode

Users need to set the dip-switch to the “Normal” position as Figure 3 and reset the power, and then the GW-7238D would run in the operation mode.

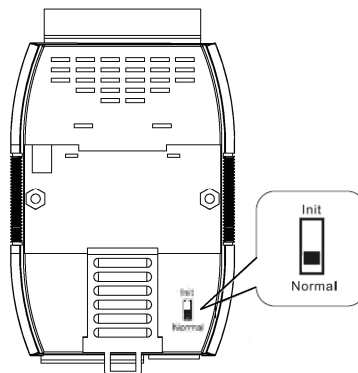

Figure 3: Operation mode Position of Dip-Switch

Step2: J1939 network - CAN bus connection

Connect the CAN ports with the GW-7238D modules and ECU (e.g. engine) in J1939 network using the following structure as Figure 4.

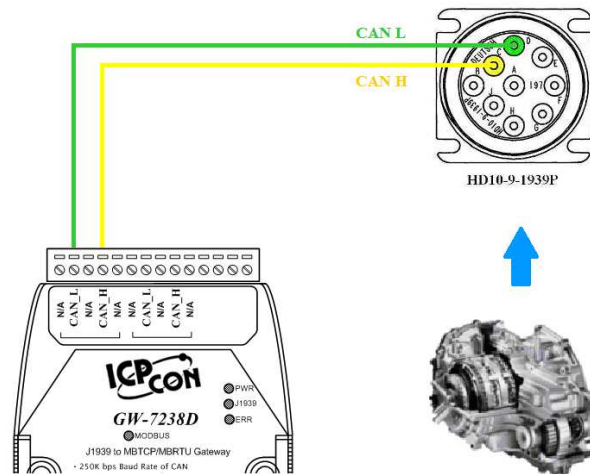

Figure 4: CAN bus Wire Connection

Step3: Modbus network - Serial / Ethernet port connection

The GW-7238D can communicate both Modbus TCP and Modbus RTU to J1939 at the same time. In Modbus RTU communication, it is recommended to use only one serial port (RS-232 or RS-485) of the gateway at the same time.

The following figures describe the COM, Ethernet and Power port connections.

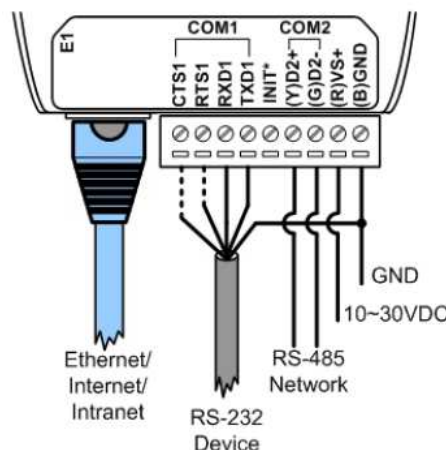

Figure 5: COM, Ethernet and Power port connections of GW-7238D

Step4: Power wire connection

Connect the power supply to the GW-7238D module's power terminal connector; please see as Figure 5.

Step5: Connect to GW-7238D

When in the first connection, the controller may run the **Serial network** at 115200 baud with none parity, 1 stop bit and 1 Net ID; or run the **Ethernet network** and set on the same subnet to connect via IP address(192.168.255.1) shown as below figure.

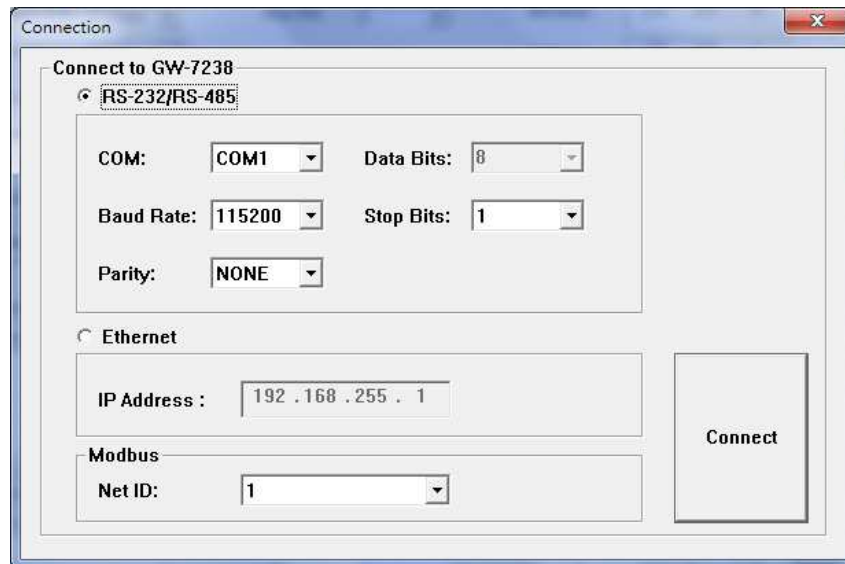

Figure 6: Connection Interface of GW-7238D Utility

● GW-7238D Utility Configuration

■ Modbus Network Configuration

The GW-7238D and the controller must be set the same serial communication parameters or be on the same subnet via Ethernet communication of the Modbus network configuration. The Modbus network configuration screen from the GW-7238D is shown as Figure 7.

| Communication Settings | | | | | |
|------------------------|--------|------------|---|--------------|---------------------|
| Net ID: | 1 | Data Bits: | 8 | IP Address : | 192 . 168 . 255 . 6 |
| Baud Rate: | 115200 | Stop Bits: | 1 | Net Mask : | 255 . 255 . 0 . 0 |
| Parity: | NONE | | | Gateway : | 192 . 168 . 0 . 1 |

Figure 7: Modbus configuration screen

■ J1939 Network Configuration

The device NAME should be set according to the application and the vendor where the module is being used based on the J1939 network specification.

The J1939 network configuration screen from the GW-7238D is shown as Figure 8.

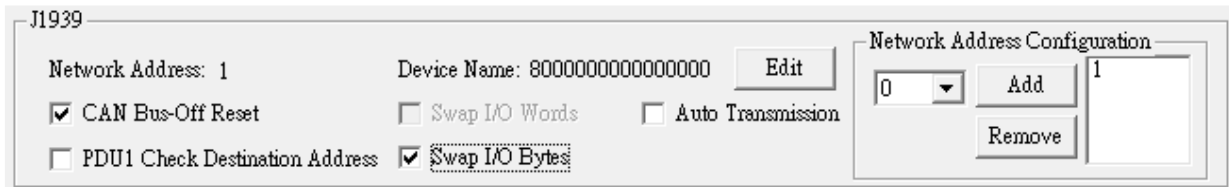

Figure 8: Modbus configuration screen

■ J1939 I/O Configuration

The following figure is a PGN definition about Electronic Transmission Controller when users want to receive the Transmission Output Shaft Speed from the transmission and send the Transmission Input Shaft Speed to the transmission via the GW-7238D.

| PGN 61442 | | Electronic Transmission Controller 1 | | - ETC1 |
|-------------------------|---------|---|------|--------|
| Transmission Repetition | 10 ms | | | |
| Data Length: | 8 | | | |
| Data Page: | 0 | | | |
| PDU Format: | 240 | | | |
| PDU Specific: | 2 | PGN Supporting Information: | | |
| Default Priority: | 3 | | | |
| Parameter Group Number: | 61442 | (0xF002) | | |
| Start Position | Length | Parameter Name | SPN | |
| 1.1 | 2 bits | Transmission Driveline Engaged | 560 | |
| 1.3 | 2 bits | Torque Converter Lockup Engaged | 573 | |
| 1.5 | 2 bits | Transmission Shift In Process | 574 | |
| 2-3 | 2 bytes | Transmission Output Shaft Speed | 191 | |
| 4 | 1 byte | Percent Clutch Slip | 522 | |
| 5.1 | 2 bits | Engine Momentary Overspeed Enable | 606 | |
| 5.3 | 2 bits | Progressive Shift Disable | 607 | |
| 6-7 | 2 bytes | Transmission Input Shaft Speed | 161 | |
| 8 | 1 byte | Source Address of Controlling Device for Transmission Control | 1482 | |

Figure 9: Example of a parameter group definition of SAE J1939/71

Table 4: Configuration data of J1939 and Modbus

| Parameters | PGN | Data Length (bytes) | Byte Order In J1939 Data Field | Byte Order in MODBUS | MODBUS Address |
|--------------------|-------------------------|---------------------|--------------------------------|----------------------|----------------|
| Send | | | | | |
| Input Shaft Speed | 61442(Dec) F002(Hex) | 2 | 5 | 0 | 40001 |
| Receive | | | | | |
| Output Shaft Speed | 61442(Dec) F002(Hex) | 2 | 1 | 0 | 30001 |

Note: PGN/Data Length/Byte Oder in J1939 Data Field
 => Transmission manufacturers provide the information required

Byte Order in MODBUS
 => User-defined Modbus address

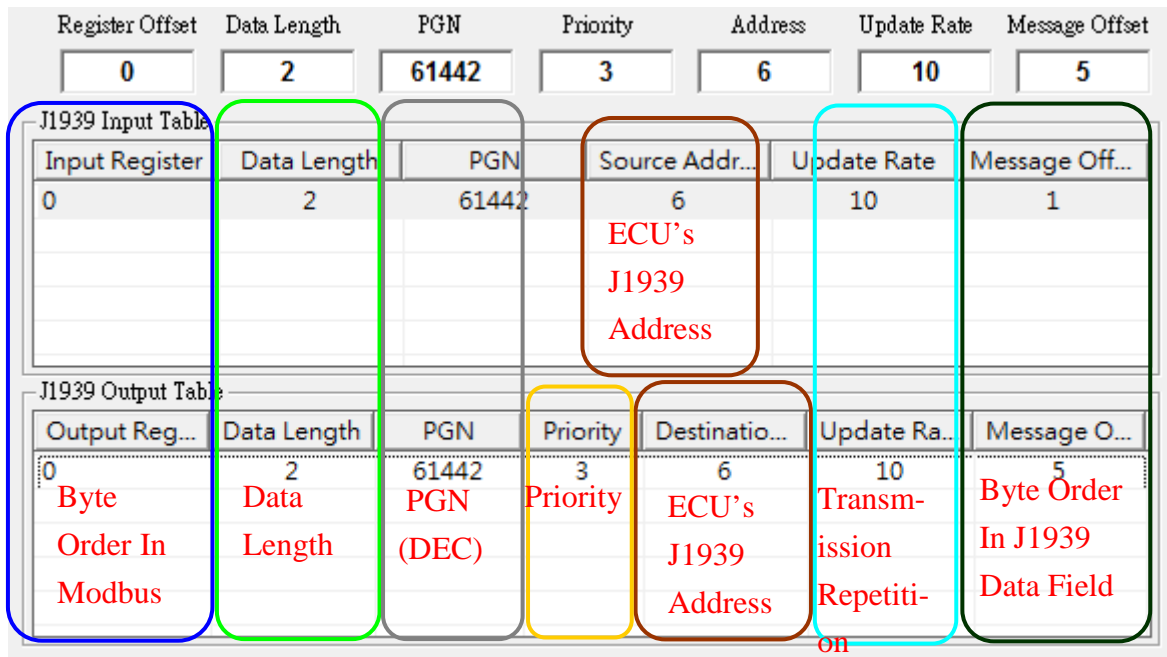

Figure 10: J1939 configuration screen

■ Upload Parameter to the GW-7238D

After the previous parameter settings, users need to upload the parameters to the GW-7238D. Please refer to the following figure to finish the operation.

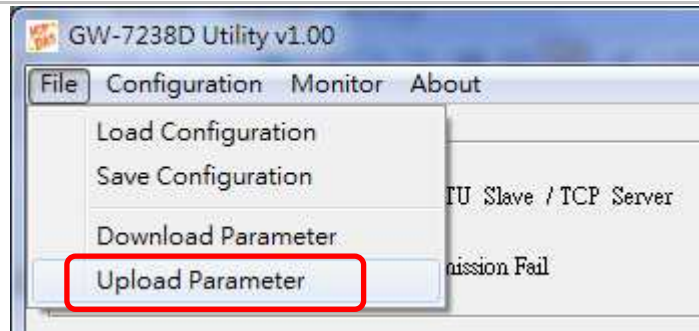

Figure 11: Parameter upload screen

■ Modbus Communication – Modbus RTU

Set J1939 output data

Using the Modbus command as below:

FC16 Write multiple registers (4xxxx) for AO

Example:

In the address 40001, write the value in 0x1234.

[Request Command] (Byte0, Byte1... Byten) (Hex)

01 10 00 00 00 01 02 12 34 AB 27(CRC)

Get J1939 input data

Using the Modbus command as below:

FC4 Read multiple input registers (3xxxx) for AI

Example:

Read a value of one word in the address 30001.

[Request] (Byte0, Byte1... Byten) (Hex)

01 04 00 00 00 01 31 CA(CRC)

GW-7238D responds a value of one word in the address 30001.

[Response](Byte0, Byte1... Byten) (Hex)

01 04 02 12 34 B4 47(CRC)

Start or Stop sending J1939 output message

1、Using the Modbus command as below:

FC6 Write single register (4xxxx) for AO

Example: Start sending J1939 output message

In the address 42009, write the value in 0x00.

[Request Command] (Byte0, Byte1... Byten) (Hex)

01 06 07 D8 00 00 08 85(CRC)

Example: Stop sending J1939 output message

In the address 42009, write the value in 0x01.

[Request Command] (Byte0, Byte1... Byten) (Hex)

01 06 07 D8 00 01 C9 45(CRC)

Or

2、Without have to control the Modbus register 42009 (Dec), just enable “Auto Transmission” function in J1939 configuration area as below, and upload to GW-7238D.



Figure 12: J1939 Auto Transmission function screen

■ Modbus Communication – Modbus TCP

Set J1939 output data

Using the Modbus command as below:

FC16 Write multiple registers (4xxxx) for AO

Example:

In the address 40001, write the value in 0x1234.

[Request Command] (Byte0, Byte1... Byten) (Hex)

00 00 00 00 00 09 01 10 00 00 00 01 02 12 34

Get J1939 input data

Using the Modbus command as below:

FC4 Read multiple input registers (3xxxx) for AI

Example:

Read a value of one word in the address 30001.

[Request] (Byte0, Byte1... Byten) (Hex)

00 00 00 00 00 06 01 04 00 00 00 01

GW-7238D responds a value of one word in the address 30001.

[Response](Byte0, Byte1... Byten) (Hex)

00 00 00 00 00 05 01 04 02 12 34

Start or Stop sending J1939 output message

1、Using the Modbus command as below:

FC6 Write single register (4xxxx) for AO

Example: Start sending J1939 output message

In the address 42009, write the value in 0x00.

[Request Command] (Byte0, Byte1... Byten) (Hex)

00 00 00 00 00 06 01 06 07 D8 00 00

Example: Stop sending J1939 output message

In the address 42009, write the value in 0x01.

[Request Command] (Byte0, Byte1... Byten) (Hex)

00 00 00 00 00 06 01 06 07 D8 00 01

Or

2、Without have to control the Modbus register 42009 (Dec), just enable “Auto Transmission” function in J1939 configuration area as below, and upload to GW-7238D.



Figure 13: J1939 Auto Transmission function screen

● Troubleshooting

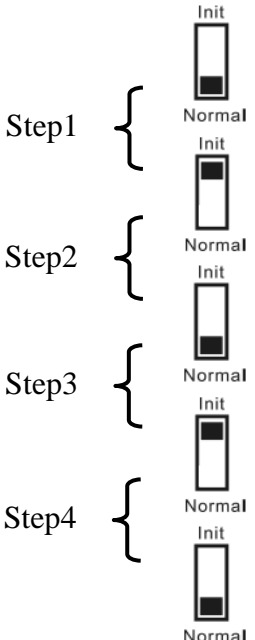
| Item | Trouble state | Solution |
|------|---|--|
| 1 | CAN Bus Transmission Fail (Power LED Blink per 100 ms) | Make sure the CAN bus wiring is connected, and connected to the correct pin. |
| 2 | CAN Bus-Off (Power LED Blink per 500 ms) | Make sure the CAN bus wiring does not short-circuit |
| 3 | Can't Claim Address in J1939 Network (Power LED Blink per 1000 ms) | Please configure another J1939 network address in GW-7238D Utility. |
| 4 | Can not transmit the output J1939 message | <ol style="list-style-type: none"> 1. Make sure the Start/Stop sending J1939 output message register (42009) is 0x00. 2. Make sure the Update Rate of J1939 output message table is not zero. |
| 5 | <p>How to restore factory default</p>  | <ol style="list-style-type: none"> 1. Power on the GW-7238D 2. Change the Dip-Switch position of the GW-7238D and to complete the following steps in 5 seconds. <ol style="list-style-type: none"> Step1. From "Normal" to "Init" position. Step2. From "Init" to "Normal" position. Step3. From "Normal" to "Init" position. Step4. From "Init" to "Normal" position. 3. When the correct implementation of the above steps, the J1939/Modbus LEDs of the GW-7238D should be turn on, and that should be turn off after 500 ms later. 4. Reset the power of the GW-7238D, and the GW-7238D |

| | | |
|--|--|--|
| | | would back to factory defaults. 6. Reconnect the GW-7238D by using the serial network setting as 115200 baud with none parity, 1 stop bit and 1 Net ID; or run the Ethernet network and set on the same subnet to connect via IP address(192.168.255.1) |
|--|--|--|

● Technical Support

If you have problems about using the GW-7238D, please contact ICP DAS Product Support.

Email: Service@icpdas.com