

# Optical Inspection

## LINOS Machine Vision Lenses and Micro Inspection Systems



## Company Profile

Qioptiq, an Excelitas Technologies Company, designs and manufactures photonic products and solutions that serve a wide range of markets and applications in the areas of medical and life sciences, industrial manufacturing, defense and aerospace, and research and development.

Qioptiq benefits from having integrated the knowledge and experience of Avimo, Gsänger, LINOS, Optem, Point Source, Rodenstock, Spindler

& Hoyer and others. In October 2013, Qioptiq was acquired by Excelitas Technologies Corp., a global technology leader focused on delivering innovative, customized solutions to meet the lighting, detection and other high-performance technology needs of OEM customers. The combined companies have approximately 6,700 employees in North America, Europe and Asia, serving customers across the world.

Visit [www.excelitas.com](http://www.excelitas.com) for more information.

1877



Rodenstock  
founded

1898



Spindler & Hoyer  
founded

1966

Pilkington PE  
Ltd. founded,  
which later  
becomes THA-  
LES Optics

1969



Gsänger  
Optoelektronik  
founded

1984



Optem  
International  
founded

1991



Point Source  
founded

1996



LINOS founded  
through the merger  
of Spindler & Hoyer,  
Steeg & Reuter  
Präzisionsoptik,  
Franke Optik and  
Gsänger Optoelektronik



**Medical &  
Life Sciences**



**Industrial  
Manufacturing**



**Defense &  
Aerospace**



**Research &  
Development**

# Content

Company Profile	02 - 03
Brochure Introduction	04 - 05
<b>LINOS Machine Vision Lenses</b>	
inspec.x L Lens Series	06 - 08
inspec.x M	09
MeVis-C Lens Series	10 - 11
APO-Rodagon-Series	12
Rodagon, Rogonar S Lens Series	13 - 14
Mechanical Accessories	15
<b>Micro Imaging Solutions</b>	
Optem FUSION Introduction	16 - 17
Optem FUSION Features	18 - 19
Optem FUSION Component Matrix	20 - 21
mag.x 125 Micro-Inspection System	22 - 23
mag.x 125 Component Matrix	24
mag.x 125 Specifications	25
MachVis Lens Selection Software	26 - 27

2000



Rodenstock  
Präzisionsoptik  
acquired  
by LINOS

2001



AVIMO Group  
acquired  
by THALES

2005

Qioptiq  
founded as  
THALES sells  
High Tech  
Optics Group

2006 / 2007



Qioptiq acquires  
LINOS and Point Source  
as "members of the  
Qioptiq group"

2010



The new Qioptiq  
consolidates all  
group members  
under one brand

2013



Qioptiq is acquired by  
Excelitas Technologies





## 4 Introduction

Our Optical Inspection products cover the broad spectrum from classical Machine Vision to non-industrial imaging with applications in life science, biometrics and direct consumer interaction. All these different applications have their very unique set of requirements that often result in application specific products. With the ever increasing range of different imaging tasks and the enormous diversity of requirements for this multitude of applications it is a huge challenge for manufacturers of inspection components to keep up and offer components that meet the latest requirements. Excelitas with its brand Qioptiq is determined to support as many of these requirements as possible and as a result we constantly add new products to our portfolio.

This brochure provides an overview of our product portfolio as of 2019 and shows the wide range of applications and requirements that is covered with a product offering which spans from traditional enlarging lenses which support large image sensors to super flexible micro imaging solutions with integrated liquid lens focusing and high speed zooming.

### mag.x system 125 - modular system for high resolution micro-inspection

The bracket around this product offering is our MachVis software that is available for more than 10 years and proved to be a reliable guide for finding the optimum solution as well as a comprehensive product database in thousands of cases.



### Lens selection software MachVis



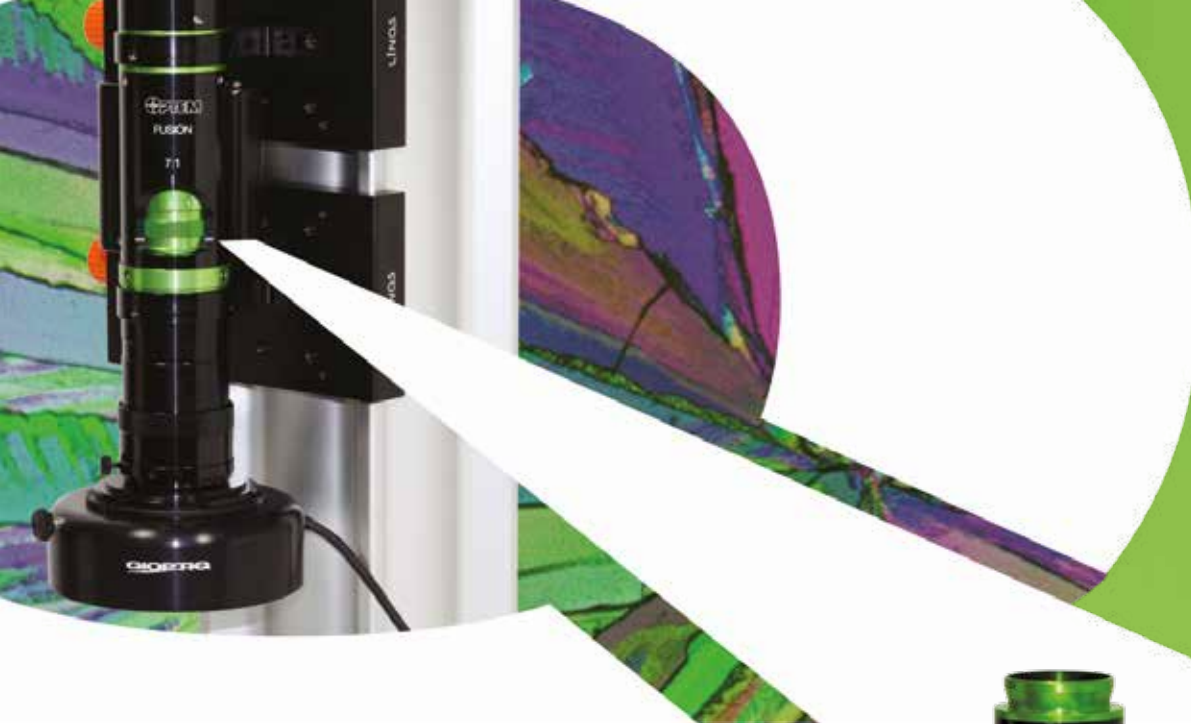

The huge part of the Optical Inspection portfolio that cannot be shown in any brochure is the vast array of customer specific products. From custom variants of standard lenses to fully integrated turnkey sub-modules this collection of specifically designed products is built with the same attention to detail using top notch optical manufacturing technologies and decades of experience in optical and mechanical design as well as patented mounting technologies for performance that matches requirements – not above, not below – just as required.



inspec.x L serie, one of our premium lens programs to meet all conceivable high resolution applications in image processing



**Components of the comprehensive OPTEM FUSION system with highest versatility**

The basis for custom as well as off-the-shelf products however is a profound understanding of market and application needs. Close collaboration with customers around the world helps us to understand what is really needed and to provide the right solution with the right performance.

**A closer look**  
 Please find additional information in our detailed separate brochures to the Qioptiq optical inspection series.  
 Receive your personal print copy:  
[Inspection@excelitas.com](mailto:Inspection@excelitas.com)

## inspec.x L 105 mm Lens Series

The inspec.x L Series was developed to meet the highest requirements in industrial image processing with very large sensors. This Lens Series shows even contrast and resolution over an image circle of up to 82 mm. The field-proven performance makes these lenses a perfect match for sensors like the popular 12k/5µm and 16k/5µm line-scan sensors. Very large area-scan sensors also benefit from the high resolution, low distortion and excellent color correction of these lenses.



- Outstanding MTF performance
- Diffraction limited optical design
- Perfect match with 5 µm pixel size
- Full-metal barrel
- Lockable aperture
- Focal length: 105 mm
- Aperture: 3.5 ... 22
- Spectral range: 400-750 nm
- Large image circle up to 82 mm
- Camera mount: V-groove

### inspec.x L

Product	Focal length (mm)	F-number	Magnification range	Image circle (mm)	Interface	Part No.
inspec.x L 5.6/105 1.0x	105	5.6	-0.85 ... -1.2	82	V-groove	0703-082-000-20
inspec.x L 5.6/105 0.76x	105	5.6	-0.6 ... -0.9	82	V-groove	0703-083-000-20
inspec.x L 5.6/105 0.5x	105	5.6	-0.4 ... -0.65	82	V-groove	0703-084-000-20
inspec.x L 5.6/105 0.33x	105	5.6	-0.25 ... -0.45	82	V-groove	0703-085-000-20

### inspec.x L 5.6/105 float

Product	Focal length (mm)	F-number	Magnification range	Image circle (mm)	Interface	Part No.
inspec.x L 5.6/105 float	105	5.6	-0.3 ... -3.0	82	V-groove	0703-114-000-20

### inspec.x L 4/105

Product	Focal length (mm)	F-number	Magnification range	Image circle (mm)	Interface	Part No.
inspec.x L 4.0/105 -3.5x	105	4.0	-3.3 ... -3.7	82	V-groove	0703-095-000-21
inspec.x L 3.5/105 -5.0x	105	3.5	-4.8 ... -5.2	82	V-groove	0703-102-000-20
inspec.x L 4.0/105 -3.0x	105	4.0	-2.8 ... -3.3	82	V-groove	0703-104-000-20
inspec.x L 4.0/105 -3.0x prism	105	4.0	-2.8 ... -3.3	82	V-groove	0703-105-000-20
inspec.x L 4.0/105 -3.5x prism	105	4.0	-3.3 ... -4.0	82	V-groove	0703-107-000-20
inspec.x L 3.5/105 -5.0x prism	105	3.5	-4.8 ... -5.2	82	V-groove	0703-108-000-20

### Prism module

Product	Part No.
Prism module	0703-107-824-00

Some example applications are:

- PCB inspection
- Display inspection
- Film and slide digitization
- High-end book scanning
- Glass inspection
- High-resolution web inspection
- 3D imaging

## A closer look

Do you know our Machine Vision Lens Selection freeware MachVis?

On page 26 you find detailed information.

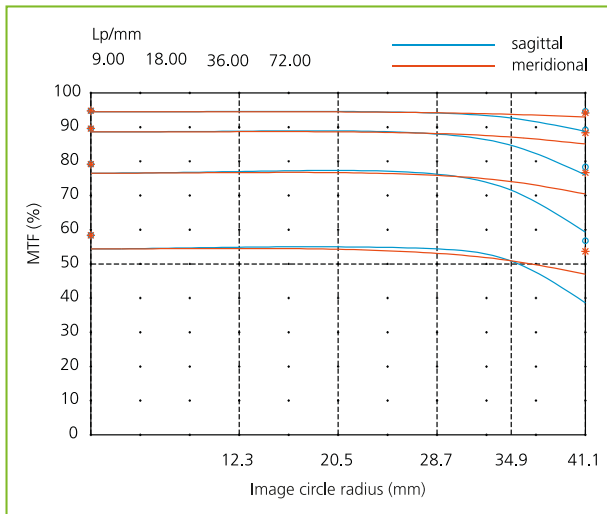

MTF of inspect.x L 5.6/105 -0.5x @  $\beta' = -0.5$  and f-stop = 5.6

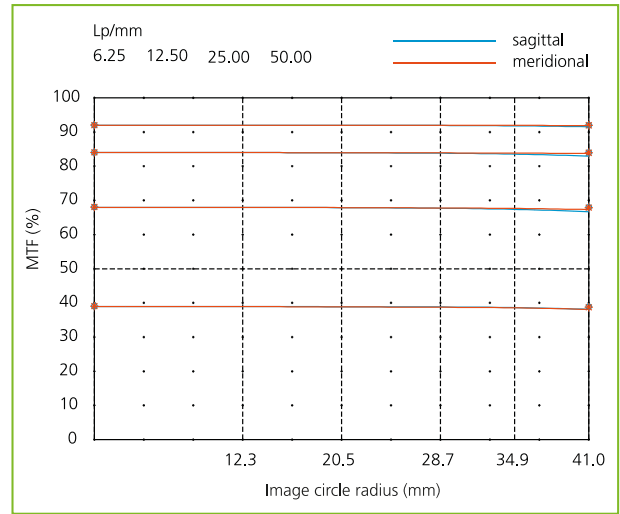

MTF of inspect.x L 4.0/105 -3.5x @  $\beta' = -3.5$  and f-stop = 4

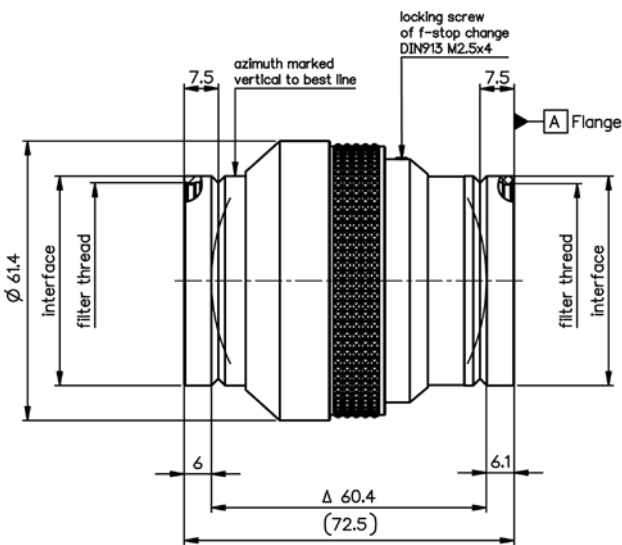

inspect.x L 5.6/105 -0.5x

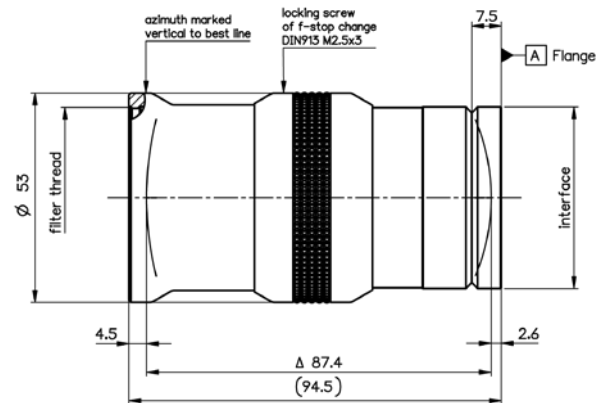

inspect.x L 4.0/105 -3.5x

## inspec.x L 4/60 and 4/100

The inspec.x L 4/60 and 4/100 are optimized for the use from infinity down through magnifications of around 0.2x. In this range these lenses show exceptional contrast over a large sensor size of up to 70mm. High contrast goes along with very good color correction and low distortion. Especially the 60mm lens provides unusually high performance for such a short focal length and enables imaging of large objects in space constrained environments with large sensors.



- High contrast for small magnifications
- Excellent color correction
- Focal length: 60 and 100 mm
- Magnifications: infinity ... 0.2
- Image circle up to 70 mm
- Spectral range: 400-750 nm
- Iris diaphragm: manual, click-stop or continuous with set screw
- Mount: compatible to Modular Focus

Both lenses feature a threaded interface to use them with the popular Modular Focus helical mount that provides access to virtually all existing cameras via different camera adapters.

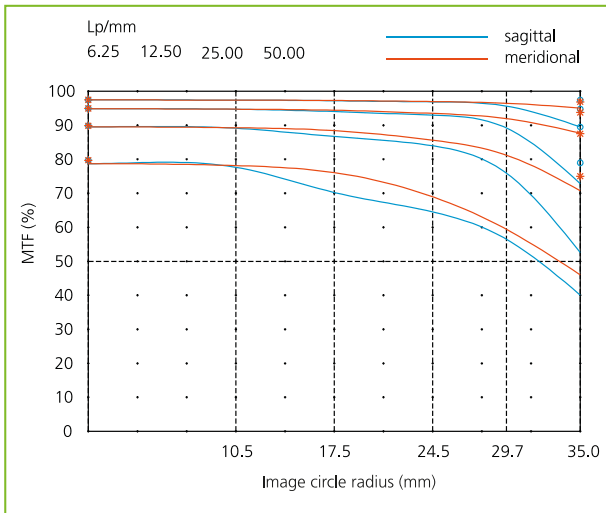

MTF of inspec.x L 4/100 @  $\beta' = -0.05$  and f-stop = 5.6

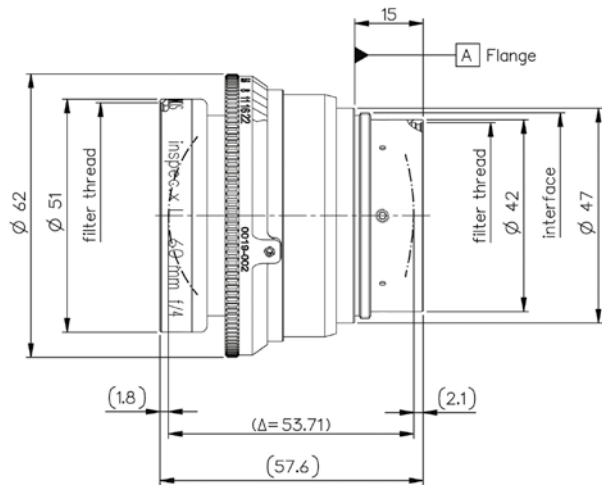

inspec.x L 4/60

## inspec.x L 4/60 and 4/100

Product	Focal length (mm)	F-number	Magnification range	Image circle (mm)	Interface	Part No.
inspec.x L 4.0/60	60	4.0	0 ... -0.2	70.8	M45x0.75	0019-002-000-50
inspec.x L 4.0/100	100	4.0	0 ... -0.2	70.4	M45x0.75	0019-003-000-50



## inspec.x M

The inspec.x M Series closes the gap between the outstanding C-Mount MeVis-C lenses and the large format inspec.x L lenses.

Equipped with lockable manual focus and manual iris these F-Mount lenses are the ideal choice for sensors up to 35 mm format when a fast f/# is required. The 1.4/50 mm lens is available for visible spectral range or near-infrared. The NIR version lens features a coating for the range from 900 to 1350 nm, making it an ideal choice for applications like electro- and photoluminescence

- Large magnification range
- Very high numerical aperture
- Low distortion
- Optical magnification: -0.07
- Image circle: 43.3 mm
- Max. sensor size: 35 mm format
- Camera mount: F-Mount
- Focusing: manual, lockable
- Iris diaphragm: manual, lockable

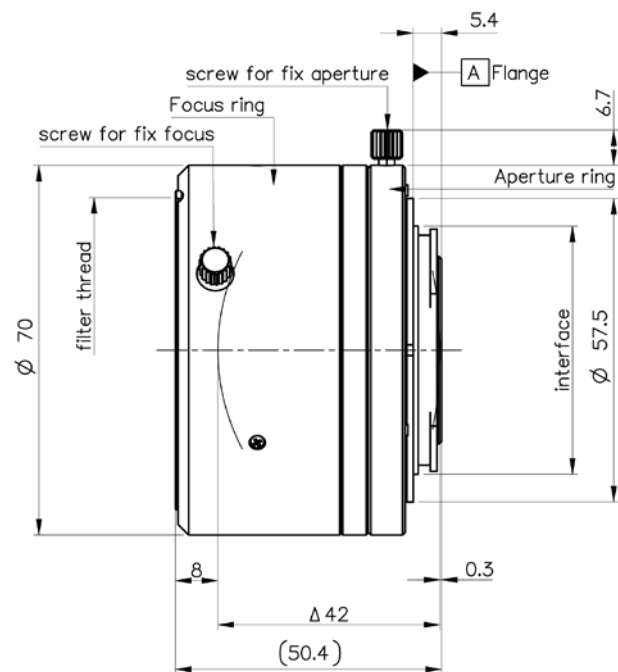

## inspec.x M

Product	Focal length (mm)	F-number	Magnification range	Image circle (mm)	Interface	Part No.
inspec.x M 1.4/50	50	1.4	0 ... -0.15	43.3	F-Mount	0009-243-000-40
inspec.x M NIR 1.4/50	50	1.4	0 ... -0.15	43.3	F-Mount	0009-243-000-42

## MeVis-C Lens Series

The LINOS MeVis-C lenses are specifically developed to be used with the highest resolution sensors available on the market. Exceptionally high resolution across the entire sensor ensures optimal performance for the most demanding applications.



High resolution is paired with low distortion, minimal light fall off and excellent chromatic correction across the entire spectral range of 450 to 900 nm. These lenses can resolve up to 200 lp/mm, even to the extreme corners of a 1" sensor.

- Highest optical performance
- Large image circle up to 1 inch
- For pixel size even below 2  $\mu$ m
- High numerical aperture
- Focal length: 12 ... 50 mm
- Magnification range: -0.1 ... 0
- Spectral range: 450-900 nm
- Focusing: manual, lockable

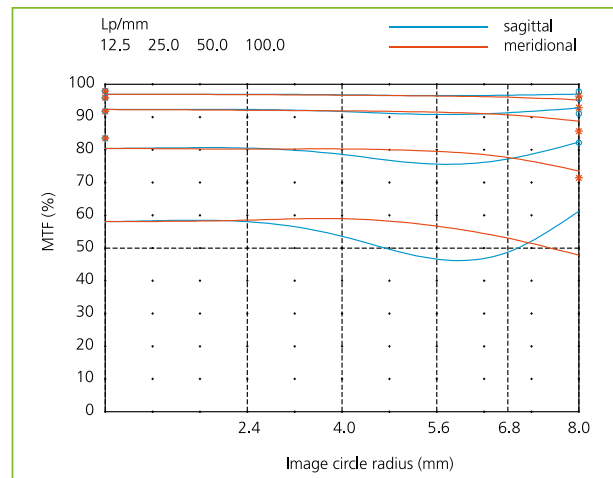

MTF of MeVis-C 1.6/35 @  $\beta' = -0.05$  and f-stop = 2.8

### MeVis-C

Product	Focal length (mm)	F-number	Magnification range	Image circle (mm)	Interface	Part No.
MeVis-C 1.8/12	12	1.8	-0.25 ... 0	11	C-Mount	0020-005-000-40
MeVis-C 1.6/16	16	1.6	-0.1 ... 0	11	C-Mount	0020-004-000-40
MeVis-C 1.6/25	25	1.6	-0.1 ... 0	16	C-Mount	0020-002-000-40
MeVis-C 1.6/35	35	1.6	-0.1 ... 0	16	C-Mount	0020-001-000-40
MeVis-C 1.8/50	50	1.8	-0.075 ... 0	16	C-Mount	0020-003-000-40

### MeVis-CF

Product	Focal length (mm)	F-number	Magnification range	Image circle (mm)	Interface	Part No.
MeVis-CF 1.6/16	16	1.6	-0.1 ... 0	11	C-Mount	0020-009-000-20
MeVis-CF 2.8/16	16	2.8	-0.1 ... 0	11	C-Mount	0020-009-000-21
MeVis-CF 4.0/16	16	4.0	-0.1 ... 0	11	C-Mount	0020-009-000-22
MeVis-CF 1.6/25	25	1.6	-0.1 ... 0	16	C-Mount	0020-007-000-20
MeVis-CF 2.8/25	25	2.8	-0.1 ... 0	16	C-Mount	0020-007-000-22
MeVis-CF 4.0/25	25	4.0	-0.1 ... 0	16	C-Mount	0020-007-000-21
MeVis-CF 1.6/35	35	1.6	-0.1 ... 0	16	C-Mount	0020-008-000-20
MeVis-CF 2.8/35	35	2.8	-0.1 ... 0	16	C-Mount	0020-008-000-21
MeVis-CF 4.0/35	35	4.0	-0.1 ... 0	16	C-Mount	0020-008-000-22
MeVis-CF 1.8/50	50	1.8	-0.075 ... 0	16	C-Mount	0020-010-000-20
MeVis-CF 2.8/50	50	2.8	-0.075 ... 0	16	C-Mount	0020-010-000-21
MeVis-CF 4.0/50	50	4.0	-0.075 ... 0	16	C-Mount	0020-010-000-22

## MeVis-C/CF Traffic

The new MeVis-C traffic lenses feature optimized color correction to eliminate focus-shift between daylight and NIR illumination around 850 nm. This optimized optical design removes the need for refocusing when switching between wavelengths as the focal plane for both illumination cases is identical. The field-proven and well known mechanics of the MeVis-C and MeVis-CF lenses remain unchanged to ensure a robust lens ready for the most demanding industrial use cases.



- Optimized for visual spectrum and NIR with identical focus plane over broad wavelength range
- Highest optical performance
- Large image circle up to 1 inch
- For pixel size even below 2  $\mu$ m
- High numerical aperture

- Spectral range: 450-900 nm
- Focusing: manual, lockable
- Iris diaphragm: manual, lockable
- Filter thread: M35.5x0.5
- Lens diameter: 42 mm

11

### MeVis-C Traffic / MeVis-CF Traffic

Product	Focal length (mm)	F-number	Magnification range	Image circle (mm)	Interface	Part No.
MeVis-C traffic 1.6/25	25	1.6	-0.1 ... 0	16	C-Mount	0020-002-000-45
MeVis-CF traffic 1.6/25	25	1.6	-0.1 ... 0	16	C-Mount	0020-007-000-30

### Application

Some example applications are:

- License plate reading (ANPR)
- Tolling
- High-resolution surveillance and recognition
- Multispectral/Hyperspectral imaging
- Document verification

**Solution MeVis-C/CF Traffic:**  
Adapted longitudinal color aberration curve for zero focus shift at 540 nm and 710 nm.

### Performance

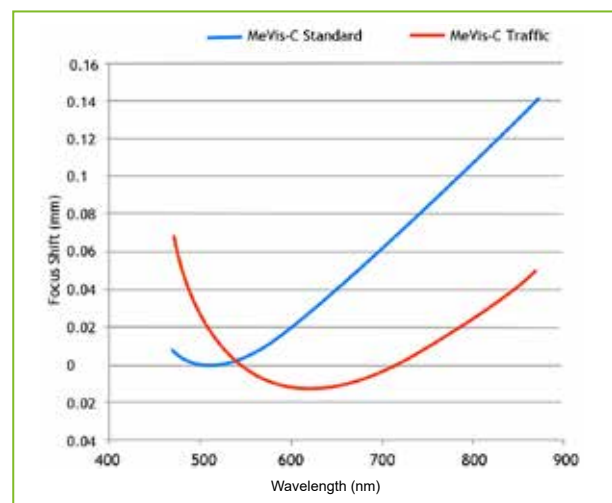

Longitudinal color aberration comparison

## APO-Rodagon-Series

The high resolution of the Apo-Rodagon lense series makes them an optimum solution for cameras with a pixel size down to 5  $\mu\text{m}$ . The high resolution is accompanied by ultra-low distortions and negligible color fringing.

Distortion is corrected to near zero and cannot be seen even in critical subjects with straight-lined structures.

All standard models are fitted with click-stop or fix aperture rings. The metal version has a continuous iris with set screw.

- Specially designed for scanning applications and large imaging sensors
- Large image circle up to 102 mm
- Focal length: 50 ... 120 mm
- Magnification range: -0.05 ... -3.0
- Spectral range: 400-750 nm
- Iris diaphragm: fix, manual, click-stop or continuous with set screw



Apo-Rodagon-D 4.0/75 1x

Apo-Rodagon-D 4.5/120 2x metal

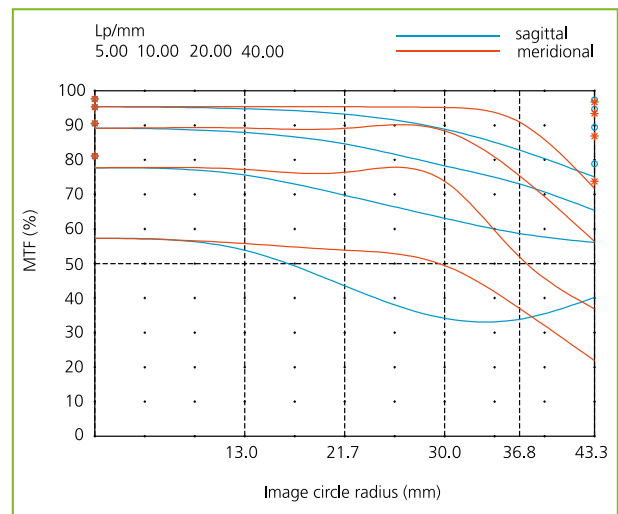

MTF of Apo-Rodagon-D 4.5/75 2x @  $\beta' = -0.5$  and f-stop = 5.6

### Apo-Rodagon-HR

Product	Focal length (mm)	F-number	Magnification range	Image circle (mm)	Interface	Part No.
Apo-Rodagon-HR 5.6/75 0.5x	75	5.6	-0.65 ... -0.35	62	V-groove	0703-109-000-20
Apo-Rodagon-HR 8/75 0.5x	75	8	-0.65 ... -0.35	62	V-groove	0703-109-000-21

### Apo-Rodagon-D

Product	Focal length (mm)	F-number	Magnification range	Image circle (mm)	Interface	Part No.
Apo-Rodagon-D 4.0/75 1x	75	4.0	-1.2 ... -0.8	82	M39x1/26"	0703-005-000-40
Apo-Rodagon-D 4.5/75 2x	75	4.5	-0.8 ... -0.4	86.8	M39x1/26"	0703-028-000-21
Apo-Rodagon-D 5.6/120 2x	120	5.6	-0.8 ... -0.33	102	M39x1/26"	0703-043-000-20
Apo-Rodagon-D 5.6/120 2x metal	120	5.6	-0.8 ... -0.33	102	M39x1/26"	0703-043-000-22

### Apo-Rodagon-N

Product	Focal length (mm)	F-number	Magnification range	Image circle (mm)	Interface	Part No.
Apo-Rodagon-N 2.8/50	50	2.8	-0.5 ... -0.05	44	M39x1/26"	0701-349-000-40
Apo-Rodagon-N 4.0/80	80	4.0	-0.5 ... -0.067	86	M39x1/26"	0703-092-000-40
Apo-Rodagon-N 4.0/90	90	4.0	-0.5 ... -0.066	90	M39x1/26"	0703-094-000-20
Apo-Rodagon-N 4.0/105	105	4.0	-0.5 ... -0.06	100	M39x1/26"	0703-096-000-40
Apo-Rodagon-N 4.0/105 metal	105	4.0	-0.5 ... -0.06	100	M39x1/26"	0703-096-000-41

## Rodagon-F/M42

The Rodagon-F/M42 Series was developed by Qioptiq to adapt precision industrial-grade optics to an F or M42 Mount camera, with a great price/performance ratio. Now, for the first time, users can integrate world renowned Rodenstock image quality in 40 - 60 mm focal lengths directly onto F-Mount cameras. A revolutionary design eliminates all moving parts to offer exceptionally robust performance. The smooth focusing is locked with a massive retaining ring that is fixed with additional screws.

The Rodagon-F/M42 lenses are available in different versions with fixed apertures. The fixed aperture prevents accidental misadjustment of the iris or slowly shifting aperture values due to vibrations. The image circle is large enough for sensors with 35 mm format and the popular 41 mm line sensors.



- Integrated manual focussing
- Suitable for line-scan cameras and large imaging sensors
- Large image circle up to 46 mm
- High numerical aperture
- Focal length: 40 ... 60 mm
- Magnification range: 0 ... -0.5
- Spectral range: 400-750 nm
- Iris diaphragm: fix
- Mount: F-Mount/M42x1
- Filter thread: M40.5x0.5

### Rodagon-F

Product	Focal length (mm)	F-number	Magnification range	Image circle (mm)	Interface	Part No.
Rodagon-F 4/40	40	4	-0.5 ... 0	44	F-Mount	0703-090-000-25
Rodagon-F 5.6/40	40	5.6	-0.5 ... 0	44	F-Mount	0703-090-000-26
Rodagon-F 8/40	40	8	-0.5 ... 0	44	F-Mount	0703-090-000-27
Rodagon-F 2.8/50	50	2.8	-0.5 ... 0	46	F-Mount	0703-089-000-24
Rodagon-F 4/50	50	4	-0.5 ... 0	46	F-Mount	0703-089-000-25
Rodagon-F 5.6/50	50	5.6	-0.5 ... 0	46	F-Mount	0703-089-000-26
Rodagon-F 4/60	60	4	-0.5 ... 0	44	F-Mount	0703-087-000-25
Rodagon-F 5.6/60	60	5.6	-0.5 ... 0	44	F-Mount	0703-087-000-26
Rodagon-F 8/60	60	8	-0.5 ... 0	44	F-Mount	0703-087-000-27

### Rodagon-M42

Product	Focal length (mm)	F-number	Magnification range	Image circle (mm)	Interface	Part No.
Rodagon-M42 4/40	40	4	-0.5 ... 0.05	41.2	M42x1	0703-118-000-25
Rodagon-M42 5.6/40	40	5.6	-0.5 ... 0.05	41.2	M42x1	0703-118-000-26
Rodagon-M42 8/40	40	8	-0.5 ... 0.05	41.2	M42x1	0703-118-000-27
Rodagon-M42 2.8/50	50	2.8	-0.5 ... 0.03	40.0	M42x1	0703-119-000-24
Rodagon-M42 4/50	50	4	-0.5 ... 0.03	40.0	M42x1	0703-119-000-25
Rodagon-M42 5.6/50	50	5.6	-0.5 ... 0.03	40.0	M42x1	0703-119-000-26
Rodagon-M42 4/60	60	4	-0.5 ... 0.03	39.6	M42x1	0703-120-000-25
Rodagon-M42 5.6/60	60	5.6	-0.5 ... 0.03	39.6	M42x1	0703-120-000-26
Rodagon-M42 8/60	60	8	-0.5 ... 0.03	39.6	M42x1	0703-120-000-27



## Rodagon, Rodagon-WA, Rogonar S

The Linos measuring lenses developed by Qioptiq feature the highest resolution, excellent contrast, minimum distortion and color neutrality. They sharply reproduce images all the way to the very edges of the object.



- Suitable for line-scan cameras and large imaging sensors
- Large image circle up to 105 mm
- High numerical aperture
- Adapter available for all common camera interfaces

- Focal length: 28 ... 135 mm
- Magnification range: -0.03 ... -0.5
- Spectral range: 400-750 nm
- Iris diaphragm: manual, click-stop or continuous with set screw
- Filter thread: M40.5x0.5

14

### Rodagon

Product	Focal length (mm)	F-number	Magnification range	Image circle (mm)	Interface	Part No.
Rodagon 2.8/28	28	2.8	-0.2 ... -0.03	32	M32x0.5	0701-389-000-20
Rodagon 4.0/35	35	4.0	-0.2 ... -0.03	40	M39x1/26"	0701-401-000-40
Rodagon 2.8/50	50	2.8	-0.5 ... -0.07	44	M39x1/26"	0701-345-000-40
Rodagon 4.0/60	60	4.0	-0.5 ... -0.06	56	M39x1/26"	0701-393-000-40
Rodagon 4.0/60 azimuth	60	4.0	-0.5 ... -0.06	56	M39x1/26"	0701-393-000-43
Rodagon 4.0/80	80	4.0	-0.5 ... -0.06	62	M39x1/26"	0701-391-000-40
Rodagon 4.0/80 azimuth	80	4.0	-0.5 ... -0.06	62	M39x1/26"	0701-391-000-42
Rodagon 4.0/80 metal	80	4.0	-0.5 ... -0.06	62	M39x1/26"	0701-391-000-44
Rodagon 5.6/105	105	5.6	-0.5 ... -0.06	104	M39x1/26"	0701-394-000-40
Rodagon 5.6/105 azimuth	105	5.6	-0.5 ... -0.06	104	M39x1/26"	0701-394-000-41
Rodagon 5.6/105 metal	105	5.6	-0.5 ... -0.06	104	M39x1/26"	0701-394-000-42
Rodagon 5.6/135	135	5.6	-0.5 ... -0.1	105	M39x1/26"	0701-398-000-40

### Rodagon-WA

Product	Focal length (mm)	F-number	Magnification range	Image circle (mm)	Interface	Part No.
Rodagon-WA 4.0/40	40	4.0	-0.25 ... -0.066	46	M39x1/26"	0701-399-000-40
Rodagon-WA 4.0/40 metal	40	4.0	-0.25 ... -0.066	46	M39x1/26"	0701-399-000-42
Rodagon-WA 4.0/60	60	4.0	-0.25 ... -0.066	82	M39x1/26"	0701-276-000-40

### Rogonar-S

Product	Focal length (mm)	F-number	Magnification range	Image circle (mm)	Interface	Part No.
Rogonar-S 2.8/50	50	2.8	-0.4 ... -0.075	44	M39x1/26"	0801-397-000-40
Rogonar-S 4.5/60	60	4.5	-0.5 ... -0.1	56	M39x1/26"	0801-324-000-40
Rogonar-S 4.5/75	75	4.5	-0.5 ... -0.1	44	M39x1/26"	0801-325-000-40
Rogonar-S 4.5/75 metal	75	4.5	-0.5 ... -0.1	44	M39x1/26"	0801-325-000-41
Rogonar-S 4.5/90	90	4.5	-0.5 ... -0.125	82	M39x1/26"	0801-398-000-41

## Modular and Smart Focus

The Modular Focus is a helical mount with 25mm of travel range and a locking screw. The Smart Focus is an economical version of the Modular Focus with a M39.1/26" (Leica) lens tread and 12.4mm of travel range.

### Modular Focus

Product	Part No.
Modular Focus Helical mount	2408-009-000-42
Extension tube 24.5 mm M45x0.75	2408-009-113-00
Extension tube 60 mm M45x0.75	2408-009-123-00
Extension tube 87.5 mm M45x0.75	2408-009-122-00

### Smart Focus

Product	Part No.
Smart focus	2408-021-000-43
Extension tube 12 mm M39x1/26"	2408-021-108-00
Extension tube 24 mm M39x1/26"	2408-021-109-00
Extension tube 48 mm M39x1/26"	2408-021-110-00
Extension tube 120 mm M39x1/26"	2408-021-111-00

### Camera Adapter

Product	Part No.
Camera adapter C-Mount	2408-009-106-00
Camera adapter F-Mount	2408-009-142-00
Camera adapter M42x1	2408-009-119-00
Camera adapter M48x0.75	2408-009-148-00
Camera adapter M58x0.75	2408-009-132-00
Camera adapter M72x0.75	2408-009-134-00
Camera adapter M90x1.0	2408-009-166-00
Camera adapter M95x1.0	2408-009-155-00

### Camera Extension Tubes

Product	Part No.
Extension tube M72x0.75-24mm	2408-009-135-00
Extension tube M90x1.0-24mm	2408-009-167-00
Extension tube M95x1.0-24mm	2408-009-156-00

### Lens Adapter

Product	Part No.
Lens adapter M32.5x0.5	2408-009-111-00
Lens adapter M39x1/26"	2408-009-118-00
Lens adapter M39x1/26" *)	2408-009-112-00
Lens adapter M45-V-groove	2408-009-147-00

\*) To be used with Rodagon 5.6/135; Apo-Rodagon-D 4.5/75 2x; Apo-Rodagon-D 5.6/120 2x; Apo-Rodagon-N 4.0/105

### Retro Rings

Product	Part No.
Retro ring M40.5x0.5 - M39x1/26"	2408-009-158-00
Retro ring M37x0.75 - M45x0.75	2408-009-152-00

### Focus Tube inspec.x L 105

Product	Part No.
Focus tube M72 for inspec.x L 105 mm -0.33x and -0.5x	2408-012-000-31
Focus tube M72 for inspec.x L 105 mm -0.76x and -1.0x	2408-012-000-30
Focus tube M72 for inspec.x L 105 mm -3.0x and -3.5x	2408-012-000-47
Focus tube M72 for inspec.x L 105 mm -5.0x	2408-012-000-33
Focus tube M95 for inspec.x L 105 mm -0.33x and -0.5x	2408-012-000-41
Focus tube M95 for inspec.x L 105 mm -0.76x and -1.0x	2408-012-000-43
Focus tube M95 for inspec.x L 105 mm -3.0x and -3.5x	2408-012-000-46
Focus tube M95 for inspec.x L 105 mm -5.0x	2408-012-000-45

15



Modular focus



Smart focus



Camera adapter M42



Lens adapter

## Optem FUSION

### Extreme Micro-Imaging Versatility

The all new Optem FUSION Lens System incorporates expanded functionality, bi-directional infinity optics, and a uniform modular matrix to provide OEMs with the ideal lens solution for streamlined integration of high-magnification imaging across they key Visible (400nm - 700nm), NIR (700nm - 1100nm) and **SWIR** (900nm - 1700nm) wavelength ranges.

Simply change-out modules to modify the form, function and performance of your Optem FUSION Lens System to meet the exact wavelength range, spatial, functional, mounting and imaging requirements of your system.

### OEM-Optimized to Streamline Time-to-Market

A FUSION imaging solution can be designed and configured in minutes... not hours. And FUSION's modular offering of universally interchangeable components means your prototype is in place in days... not months.

### Configured to Your Application

Using standard FUSION Lens matrix components, Qioptiq has the optical design prowess and manufacturing expertise to incorporate virtually any optical microscopy feature into your Optem FUSION Lens System. Specialized components and custom-tailored configurations are simple, expedient and cost effective.

#### 40 years of experience

We coalesces 40 years of Optem® Lens manufacturing expertise into the perfect fusion of performance, simplicity and flexibility.



### Unmatched Modular Imaging Flexibility

- Configure for versatile 7:1 or 12.5:1 zoom optics or for a wide range of economical fixed magnifications
- NOW, All FUSION Lens System accessories are compatible with the NEW Fetura+ High-Performance Automated Zoom Lens
- NOW, Optem FUSION enables extreme broadband imaging support across the visible and **SWIR** wavebands (400nm - 1700nm)
- Swap out lower lenses or LWD objectives to configure a wide range of imaging envelopes
- Interchange Camera Mounts and Camera Tubes to optimize sensor coverage for virtually any camera format or mount
- Integrate coaxial or ringlight LED illumination and automate focus and/or zoom with stepper motors
- Plug-n-play programmable control for multi-axis illumination focus and zoom
- Incorporate accessories at virtually any point of the lens assembly
- Space-efficient inline multi-point mounts ensure added imaging stability



### Camera Mount

Mates FUSION with C, CS, F, EOS, 4/3-mount cameras and more

### Camera Tube

Modifies magnification to your camera optimizing chip coverage and performance

### Core Optical Module

Determines optical function: Fixed, 7:1 or 12.5:1 zoom magnification - motorized or manual

### Lower Function Module

Integrates internal focus - motorized or manual - and coaxial LED illumination options

### Lower Lens

Modifies taking magnification to affect field of view, NA and working distance

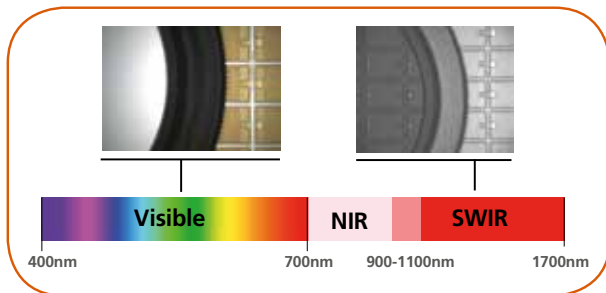

Broad wavelength support makes FUSION the perfect solution for:

- Through silicon defect inspection and alignment
- Hyperspectral imaging
- Fluorescence imaging
- Metrology

## FUSION Performance

### Fixed Magnification

#### MINIMUM CONFIGURATION

Magnification.....	0.16X
NA .....	0.005
Resolution .....	15.0 lp/mm
Depth-of-Field .....	23 mm
Field-of-View* .....	41 x 55 mm
Working Distance.....	490 mm

#### MAXIMUM CONFIGURATION

Magnification.....	12X
NA .....	0.18
Resolution .....	540 lp/mm
Depth-of-Field .....	0.018 mm
Field-of-View* .....	0.55 x 0.73 mm
Working Distance.....	32 mm

### 7:1 Zoom Magnification

#### MINIMUM CONFIGURATION

	Low Zoom	High Zoom
Magnification	0.067X	0.46X
NA	0.0047	0.016
Resolution (lp/mm)	14 lp/mm	47 lp/mm
Depth-of-Field (mm)	25 mm	2.4 mm
Field-of-View* (mm)	131 x 98 mm	19 x 14 mm
Working Dist. (mm)	490 mm	490 mm

#### MAXIMUM CONFIGURATION

	Low Zoom	High Zoom
Magnification	5X	35X
NA	0.047	0.16
Resolution (lp/mm)	142 lp/mm	465 lp/mm
Depth-of-Field (mm)	0.25 mm	0.024 mm
Field-of-View* (mm)	1.7 x 1.3 mm	0.25 x 0.19 mm
Working Dist. (mm)	32 mm	32 mm

### 12.5:1 Zoom Magnification

#### MINIMUM CONFIGURATION

	Low Zoom	High Zoom
Magnification	0.045X	0.55X
NA	0.0036	0.019
Resolution (lp/mm)	11 lp/mm	58 lp/mm
Depth-of-Field (mm)	44 mm	1.5 mm
Field-of-View* (mm)	196 x 147 mm	16 x 12 mm
Working Dist. (mm)	490 mm	490 mm

#### MAXIMUM CONFIGURATION

	Low Zoom	High Zoom
Magnification	3.4X	41X
NA	0.036	0.19
Resolution (lp/mm)	108 lp/mm	576 lp/mm
Depth-of-Field (mm)	0.44 mm	0.015 mm
Field-of-View* (mm)	2.6 x 1.9 mm	0.21 x 0.16 mm
Working Dist. (mm)	32 mm	32 mm

\* - All field-of-view data calculated for 2/3" camera

## FUSION Features

Optem FUSION is engineered to deliver unprecedented configuration and performance flexibility. A wide array of interchangeable components affords OEMs with forward flexibility to evolve imaging capability with the life cycle of their system, and affords researchers with quick swap-out flexibility for benchtop video microscopy applications.



### Extreme Imaging Versatility

FUSION delivers three distinct optomechanical capabilities within a single Lens System. Specify economical Fixed Magnification imaging

modules or 7:1 and 12.5:1 Zoom Optical Modules to meet your exact micro-imaging needs. Infinity Optics and uniform fitting components streamline swap-out and maximize flexibility in the development and forward evolution of your system.

18



### Optomechanical Flexibility

Integrate 90° Mirror Cubes and 50/50 Cubes at most any point along the optical path to modify the shape and fit of FUSION to your specific integration requirements. Combinations of multiple Cube Modules permit multiple cameras and lens functions to be integrated over a single optical subject.



### Achieve Higher Magnification

FUSION is optimized to image through Optem Long-Working Distance Objectives. Select from 2X to 50X in High-Resolution and M-Plan APO and Objectives.



### Tunable Lens Module

Space saving liquid lens module provides fast autofocus capabilities without cumbersome motorized focus drives. Simply inserts directly above the chosen Lower Function Module.







## Fluorescence Imaging

Two modules utilizing user supplied Zeiss type 91029 cubes. Lower module provides system fluorescence illumination and imaging. The upper module will allow two different wavelengths to be directed to separate cameras.



## Fetura+ High Speed Zoom

Replace the standard 12.5:1 FUSION core zoom module with NEW Fetura+ for increased speed and durability. Fetura+ travels through the entire zoom range in less than 1sec and offers service life in excess of 1-million cycles. Motorization and control is already built in.



## Optical Accessories

Bi-directional infinity optics allow a range of Accessory Modules including iris, filter wheels, polarizers and apertures to be integrated at most any point along the optical path.

## SWIR Compatibility

When the most detailed information is critical to your application, broad 400nm - 1700nm wavelength support facilitates multi-modality imaging and is perfect for advanced imaging techniques including hyperspectral imaging and image fusion.

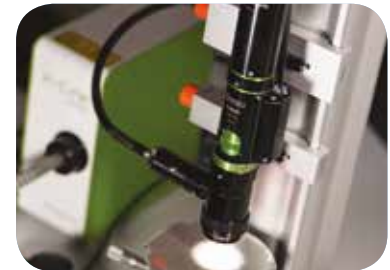

## LED Illuminator

The LED illuminator provides variable illumination levels to Optem fiber optic cables

that exceed a Halogen 150W light source. The illuminator is small and compact in size weighing only 2.7KG/5.9 lbs. It has a lifetime of more than 25,000 hours. RoHS compliant; UL and CE approved.

## Image Stable Design

Enlarged barrel diameters and wall thickness combine with a 3-point dovetail coupling interface to promote robust lens assembly. Additionally, low profile, Inline Mount Blocks allow multiple mounting points along the assembly length to ensure maximum integration stability.



# Optem® FUSION Visible/SWIR Components

## ACCESSORIES

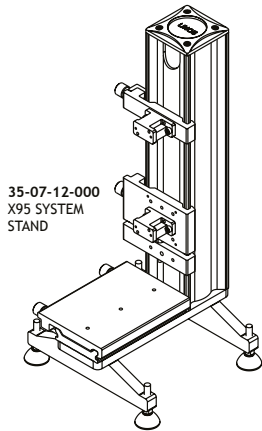
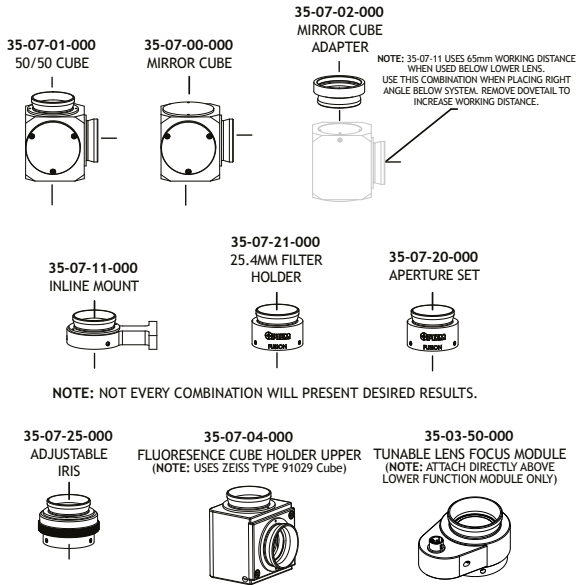

## ACCESSORIES



## CAMERA TUBES

## ACCESSORIES

## FIXED MAGNIFICATION

### 7:1 ZOOM

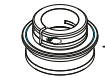
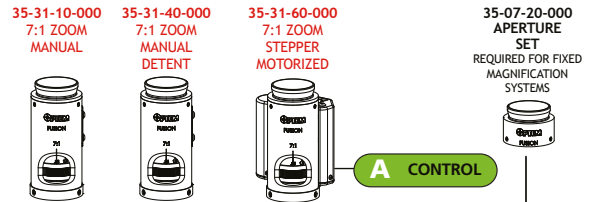

35-07-15-000 TUBE CLAMP MOUNT, 82mm dia.

35-07-16-000 TUBE CLAMP MOUNT, 83mm dia.

35-07-17-000 TUBE CLAMP MOUNT, 84mm dia.

## NOTE:

- Products listed in **RED TYPE** Indicate **SWIR** version available.
- For ordering purposes, **VISIBLE** components are identified by a "35" prefix, while **SWIR** components use a "45" e.g. 35-XX-XX-XXX **VISIBLE**, and 45-YY-YY-YYY **SWIR**
- All "35-XX" modules are compatible with one another; and all "45-YY" modules are compatible with one another.
- Using "35-XX" and "45-YY" modules with one another is not recommended.
- Non-optics mounts/modules are cross-compatible between **VISIBLE** and **SWIR**

## LOWER FUNCTION MODULES

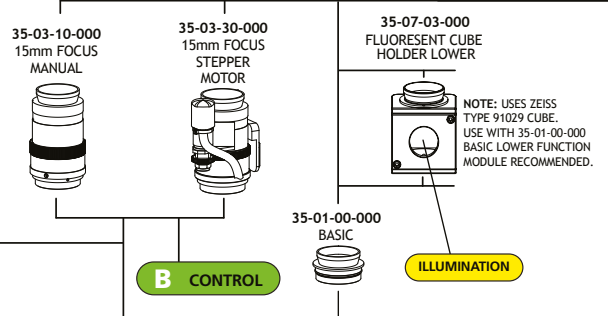

## LOWER LENSES

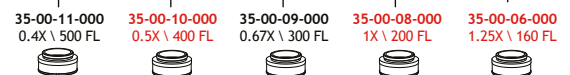

# ent Matrix

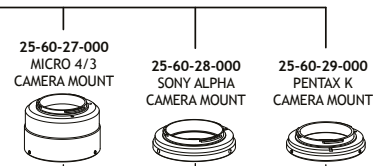

## MINI CAMERA TUBES

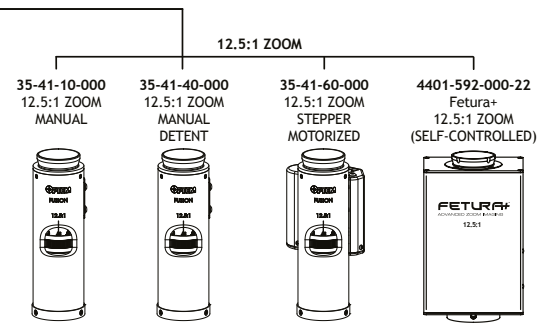
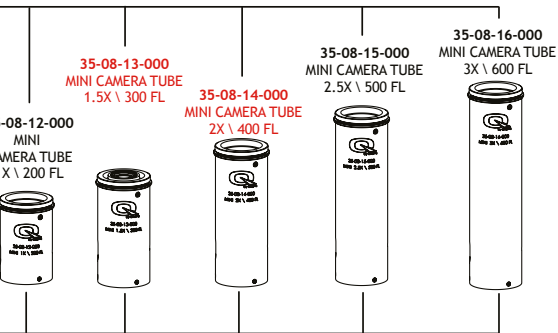

## ACCESSORIES

## A CONTROL

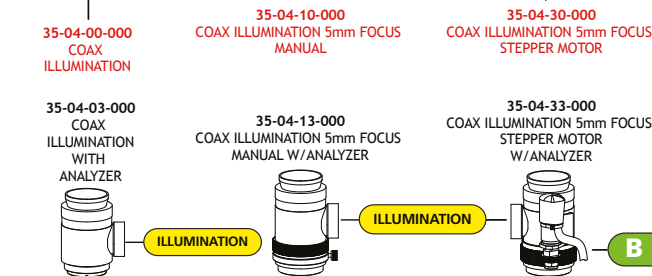

## ACCESSORIES

## ILLUMINATION



NOTE: COAX ILLUMINATION HAS LIMITED FIELD ILLUMINATION WITH LARGE FOVS.

## LIGHTING ACCESSORIES

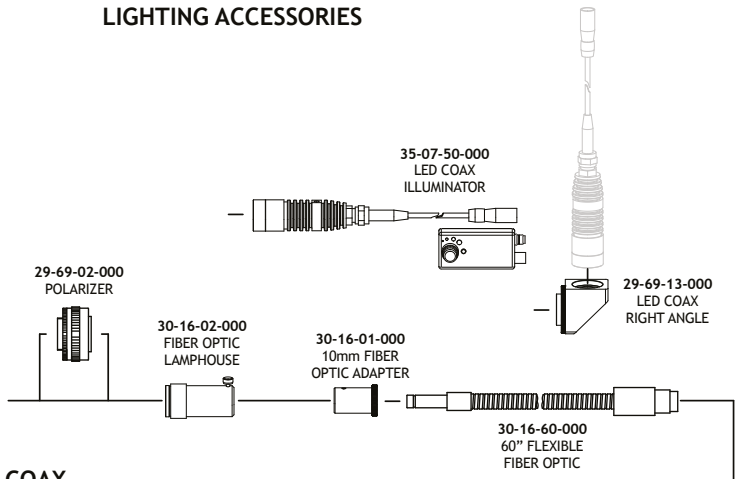

## COAX

## OBLIQUE

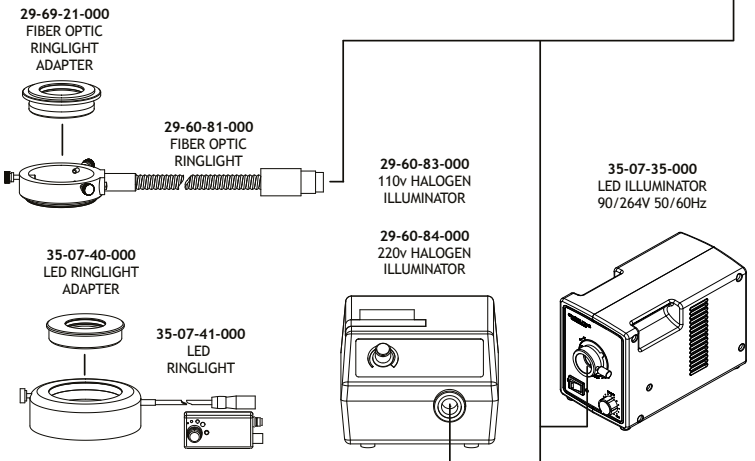

## A CONTROL

## B CONTROL

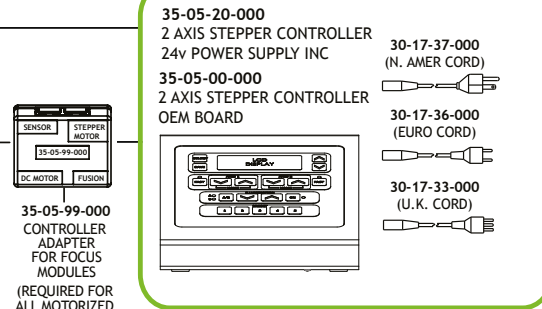

**LWD OBJECTIVES**  
 28-21-02-001 2X M PLAN APO  
 28-21-05-001 5X M PLAN APO  
 28-21-10-000 10X M PLAN APO  
 28-21-11-001 20X M PLAN APO  
 28-21-50-001 50X M PLAN APO

28-20-44-000 5X HI-RES  
 28-20-45-000 10X HI-RES  
 28-20-46-000 20X HI-RES  
 CERTAIN LIMITATIONS APPLY WITH HI-RES OBJECTIVES.  
 SEE BROCHURE FOR DETAILS.

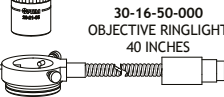

# mag.x 125 Micro-Inspection System

## Modular System

High resolution inspection is being used in many applications. Each application has its own requirements and constraints. In order to cater for all these diverse needs the mag.x system 125 is as modular as possible. Integration of customized elements is easy and enables a system that integrates seamlessly into the surrounding equipment.

make the mag.x system 125 really unique. All of Qioptiq's highest end technology is being used in manufacturing and testing of these lenses.

### Tube lenses

System magnification and maximum sensor size are the result of the combination of tube lens and objective lens. The current selection of tube lenses allows the use of sensors with a diagonal of up to 57 mm. All tube lenses are also telecentric on image side.



### Illumination

For coaxial bright field illumination Koehler illumination optics are included that can be interfaced to light sources via optical fibers or directly to LED sources.

### Accessories

No system is complete without an array of accessories. The wide selection ranges from camera and fiber adapters to mounting accessories and also includes more advanced components for focusing and special contrasting methods. The optional Piezo Unit enables fine focusing with a range of 400µm. It can be combined with the AF base unit to build a true through-the-lens AF system.

### Base units

Heart of the system is always the base unit which is available in different variations. All other components are attached to these base units. Mounting of the system to the surrounding equipment is also provided by the base unit.

### Objective lenses

The optical performance of the system is mainly defined by the objective lenses. These are the components that



22

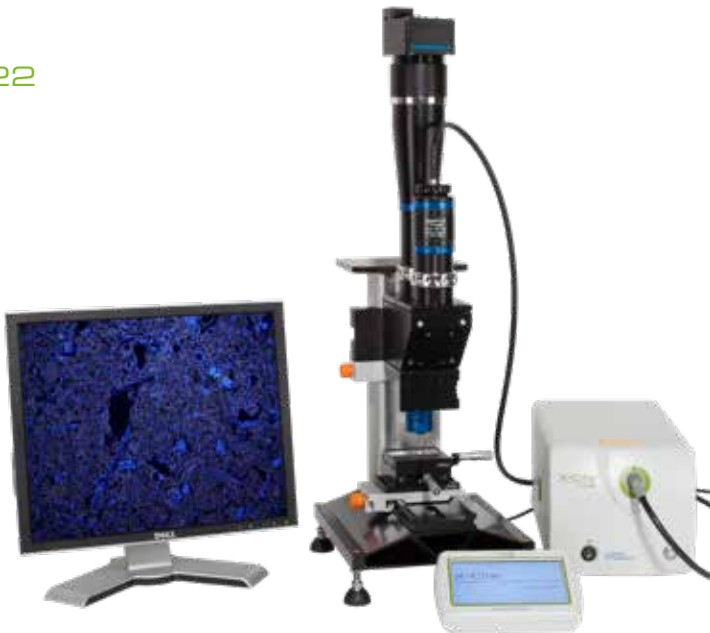



# Applications

Numerous applications benefit from the versatility and the high optical performance of the mag.x system 125. The large field-of-view increases throughput of inspection installations as more object space is imaged at once and the number of images that need to be acquired to image an object in its entirety is reduced drastically – in the best case only one image is necessary by maintaining sub- $\mu$  resolution.

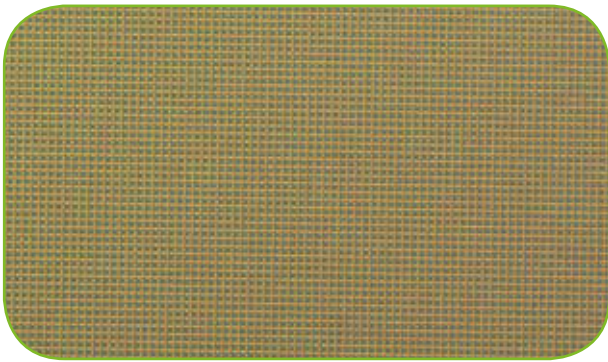

Color CCD sensor with 5.5 $\mu$ m pixel size

Typical applications include the inspection of large objects like

- Display panels
- Printed circuit boards
- Glass panels



Bovine Pulmonary Artery fluorescence sample

These objects are usually inspected with line scan cameras to achieve maximum resolution and throughput. Smaller objects can often be imaged at once or with only few images with an area scan camera. The 1.73x tube lens is specifically designed for the popular 35mm format cameras that achieve up to 50MPixel resolution. Typical applications here are

- Semiconductor inspection
- Biochip reading
- Fluorescence microscopy
- Digital pathology/histology
- High precision non-contact measurement machines
- Cleanliness of optical components

23

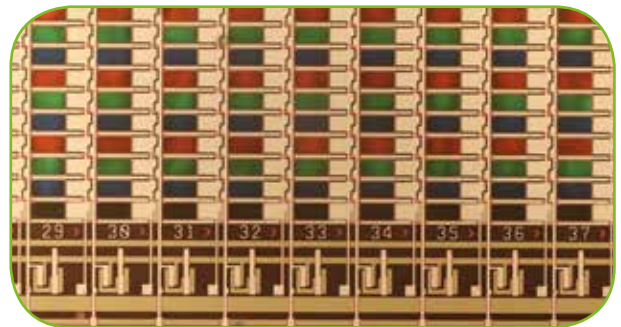

Color TFT display

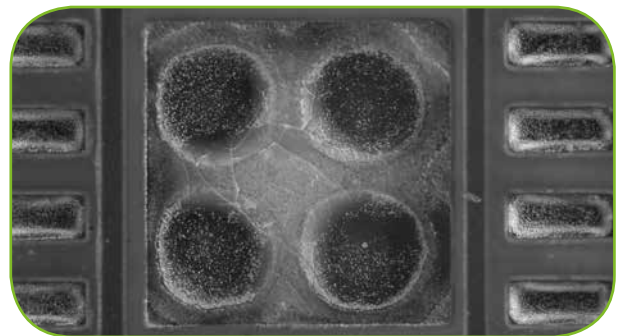

Solder points on PCB (magnification 11.25x)



# Component Matrix

24

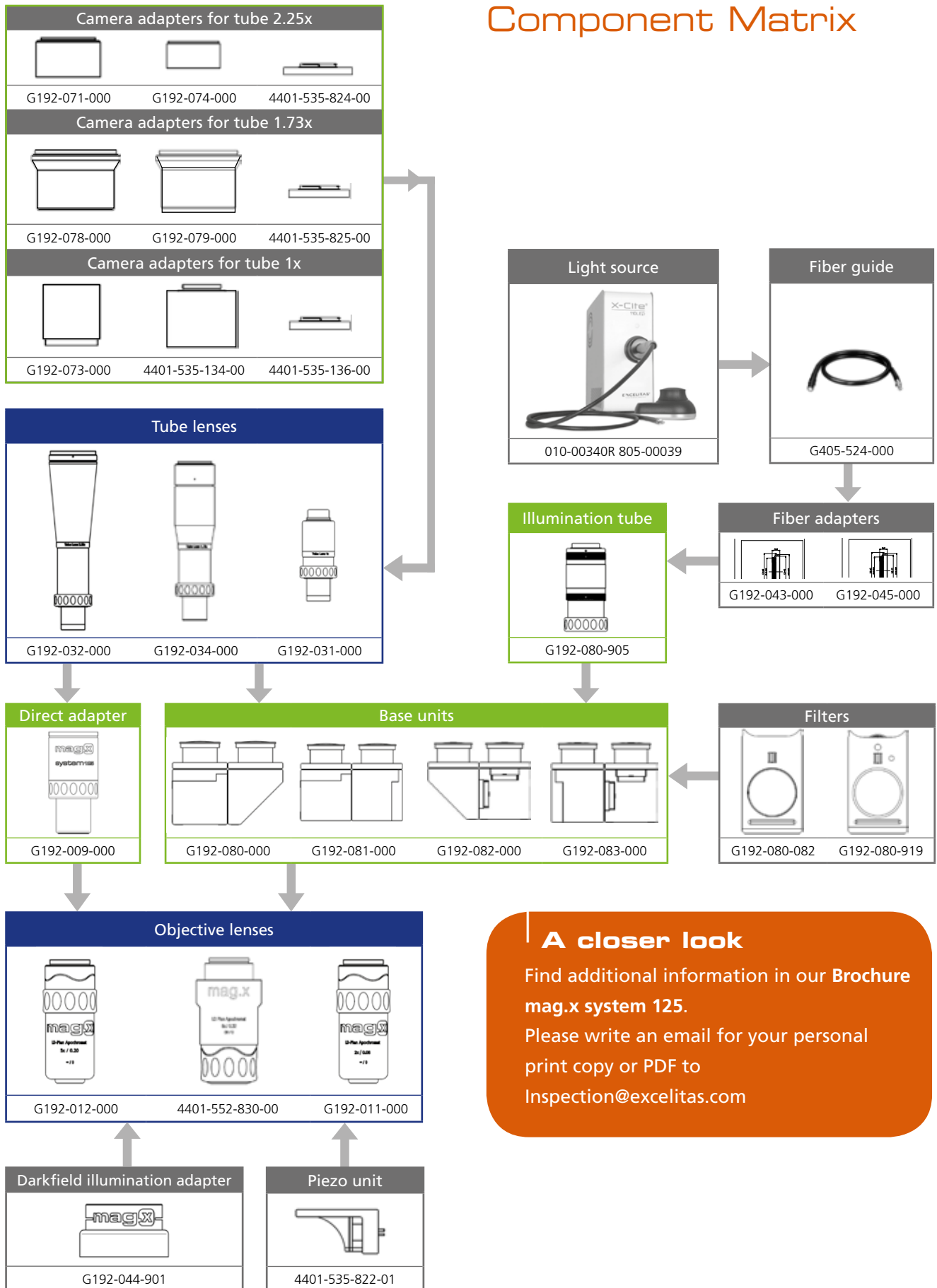

**A closer look**  
 Find additional information in our **Brochure mag.x system 125**.  
 Please write an email for your personal print copy or PDF to [Inspection@excelitas.com](mailto:Inspection@excelitas.com)

# Designed for Large Sensors

The mag.x system 125 is the first microscope system that is specifically designed for the use with large sensors to achieve true wide field imaging with high resolution. With a supported sensor diameter of 57 mm popular line scan sensors like 8k TDI sensors as well as modern super high-resolution array sensors can be used. These sensors fully utilize the high optical bandwidth of the mag.x system 125 that supports up to 50 MPixel sensor resolution.

# Optical Performance

Mag.x system 125 stands out from conventional microscope systems by numerical aperture (NA) values considerably higher than those of other systems. High optical quality is not only ensured on the optical axis, but also is maintained over the entire sensor format. The MTF chart below shows the polychromatic MTF versus field height. Values for object y and image heights y' are given under the horizontal axis. Note that the high contrast values close to the diffraction limit are maintained over the entire field!

The complete system is chromatically corrected in the spectral range of 430–700 nm. High contrast is maintained over the entire spectrum and no refocusing is required if the illumination wavelength is changed. Multispectral imaging becomes possible without any additional focus needs.

To enable even the most demanding measurement tasks the mag.x system 125 features precise object space telecentricity to prevent flawed measurements of objects with varying height.

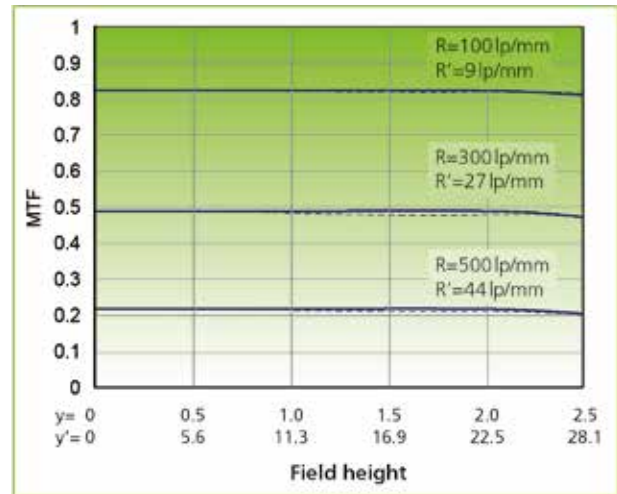

Polychromatic MTF vs. field height  
 LD Plan Apo 5x/0.2 + TL2.25x; 2y=5 mm, 2y'=56.3 mm

# Specifications

Objective Plan Apochromat					Tube Lens System											
					1x				1.73x				2.25x			
					f'tub = 250 mm				f'tub = 432.5 mm				f'tub = 563 mm			
					2y' = 25 mm				2y' = 43.3 mm				2y' = 57 mm			
Magn./NA	WD	f'obj	δobj	R0	2y			R'0	2y			R'0	2y			R'0
					M	mm	NA'		lp/mm	M	mm		NA'	lp/mm	M	
2x/0.08	24.8	125.0	±42.7	293	2	12.5	0.04	147	3.5	12.5	0.023	85	4.5	12.5	0.018	65
5x/0.20	13.0	50.0	±6.8	733	5	5.0	0.04	147	8.7	5.0	0.023	85	11.25	5.0	0.018	65
8x/0.32	23.0	31.3	±2.7	1172	8	3.1	0.04	147	13.8	3.1	0.023	85	18.0	3.1	0.018	65

NA Numerical aperture in the object space =  $n \cdot \sin(\sigma)$   
 WD Working distance  
 f'obj Focal length of the objective  
 f'tub Focal length of the tube lens

δobj Depth of field at 546 nm  $\delta_{obj} = \pm n \cdot \lambda / (2 \cdot NA^2)$   
 R'0 Cut off frequency in image space at 546 nm  
 R0 Cut off frequency in object space at 546 nm  $R_0 = (2 \cdot NA) / \lambda$   
 2y' Image field size (maximum detector diagonal)  
 2y Object field size  
 M Magnification of the overall system

# MachVis Software

LINOS MachVis software is designed to help you find the right lens for your machine vision application. Starting with four simple parameters:

- Object size
- Working distance
- Sensor size
- Camera mount

MachVis calculates the necessary optical parameters and then, from the extensive lens catalogue, selects all suitable lenses that meet your specifications.

26

If mechanical accessories (e.g. focussing unit extension tubes etc.) are needed, MachVis will create a printable, itemized list of the required parts. MachVis also generates a schematic drawing of the lens and accessories in the order of assembly.

Specifications, along with your own project notes, may be saved for later recall. Datasheets (PDF) for each lens may be viewed for a more detailed analysis.

To facilitate the mechanical design of your system as much as possible, MachVis offers the direct download of 3-D data in step or parasolid format of all lenses and accessories.



**MachVis 5.1.1**  
 Freitag, Juli 06, 2018 03:11 PM  
 Designer: arthur.stauder

**Specifications**  
 Free Working Distance - F.W.D. 200,0mm  
 Object Full diameter 70,0mm  
 Sensor (35mm) 24,0x36,0mm  
 Adapter F-Mount/Nikon  
 CBD 46,5mm

**Proposed System [object/image full diameter matched to specs]**

Qioptiq Lens	Apo Rodagon D 2x	1x	0703-028-000-21
Lens Adapter		1x	2408-009-112-00
Extension Tube	24,5mm	2x	2408-009-113-00
Focuser	Modular Focus	1x	2408-009-000-42
Camera Adapter	F-Mount/Nikon	1x	2408-009-142-00

**FOV for lens max image size 46,2mm**

Sensor FOV diag. is unreticulated [49,9mm of 129mm]

**EFL [actual] 74,80mm**  
**Free Working Distance [actual] 165,82mm**  
**Flange Focal Distance - F.F.D. [actual] 118,37mm**  
**Lens Front to Camera Front Distance 102,27mm**

Printout of the selected system

Serial	Manufacturer	Model	Mount	Length [mm]	Weight [g]	Price [€]	Availability	Orderable
01	Qioptiq	Apo Rodagon D 2x	F-Mount/Nikon	46,5	110,0	100,00	In stock	Available
02	Qioptiq	24,5mm Extension Tube		24,5	10,0	10,00	In stock	Available
03	Qioptiq	Modular Focus		10,0	5,0	5,00	In stock	Available
04	Qioptiq	F-Mount/Nikon Adapter		10,0	5,0	5,00	In stock	Available

Lens overview dialog

## MachVis Workflow

From the choice  
of lens...

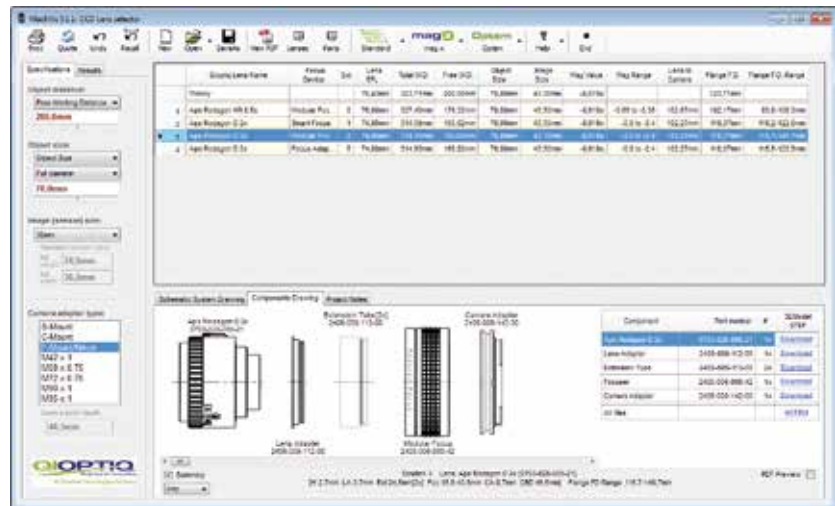

27

to 3D modelling...



to the final system:





## Your Key to Photonic Innovation...

Excelitas serves with Qioptiq a wide variety of applications across the industrial manufacturing sector. With a rich history of delivering innovative photonic components, modules and instruments to integrators, engineers and OEMs, we also offer custom-tailored photonic solutions to maximize the potential and capabilities of tomorrow's many processes and industrial manufacturing systems.

## ...and Manufacturing Advancement

### Contact us today:

Mail: [Inspection@excelitas.com](mailto:Inspection@excelitas.com)

Phone Europe  
+49 (0) 551 6935-0

Phone North America  
+1 (800) 429 0257

Phone Asia/Pacific  
+65 64 99 7777

[www.excelitas.com](http://www.excelitas.com)

