

NPN Silicon AF Transistors

BCW 60
BCX 70

- For AF input stages and driver applications
- High current gain
- Low collector-emitter saturation voltage
- Low noise between 30 Hz and 15 kHz
- Complementary types: BCW 61, BCX 71 (PNP)

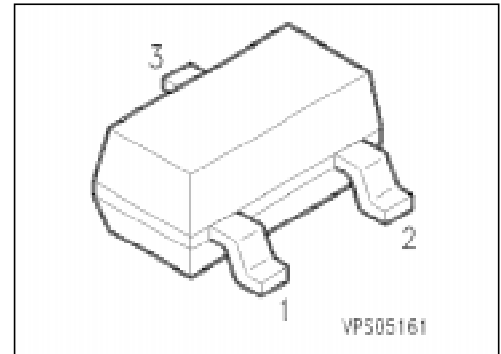

Type	Marking	Ordering Code (tape and reel)	Pin Configuration			Package ¹⁾
			1	2	3	
BCW 60 A	AAs	Q62702-C1517	B	E	C	SOT-23
BCW 60 B	ABs	Q62702-C1497				
BCW 60 C	ACs	Q62702-C1476				
BCW 60 D	ADs	Q62702-C1477				
BCW 60 FF	AFs	Q62702-C1529				
BCW 60 FN	ANs	Q62702-C1567				
BCX 70 G	AGs	Q62702-C1539				
BCX 70 H	AHs	Q62702-C1481				
BCX 70 J	AJs	Q62702-C1552				
BCX 70 K	AKs	Q62702-C1571				

¹⁾ For detailed information see chapter Package Outlines.

Maximum Ratings

Parameter	Symbol	Values			Unit
		BCW 60	BCW 60 FF	BCX 70	
Collector-emitter voltage	V_{CE0}	32	32	45	V
Collector-base voltage	V_{CB0}	32	32	45	
Emitter-base voltage	V_{EB0}	5			
Collector current	I_C	100			mA
Peak collector current	I_{CM}	200			
Peak base current	I_{BM}	200			
Total power dissipation, $T_s = 71\text{ °C}$	P_{tot}	330			mW
Junction temperature	T_j	150			°C
Storage temperature range	T_{stg}	- 65 ... + 150			

Thermal Resistance

Junction - ambient ¹⁾	$R_{th\ JA}$	≤ 310	K/W
Junction - soldering point	$R_{th\ JS}$	≤ 240	

¹⁾ Package mounted on epoxy pcb 40 mm × 40 mm × 1.5 mm/6 cm² Cu.

Electrical Characteristics

at $T_A = 25\text{ °C}$, unless otherwise specified.

Parameter	Symbol	Values			Unit
		min.	typ.	max.	

DC characteristics

Collector-emitter breakdown voltage $I_C = 10\text{ mA}$ BCW 60, BCW 60 FF BCX 70	$V_{(BR)CE0}$	32 45	— —	— —	V
Collector-base breakdown voltage $I_C = 10\text{ }\mu\text{A}$ BCW 60, BCW 60 FF BCX 70	$V_{(BR)CB0}$	32 45	— —	— —	
Emitter-base breakdown voltage $I_E = 1\text{ }\mu\text{A}$	$V_{(BR)EB0}$	5	—	—	
Collector cutoff current $V_{CB} = 32\text{ V}$ $V_{CB} = 45\text{ V}$ $V_{CB} = 32\text{ V}, T_A = 150\text{ °C}$ $V_{CB} = 45\text{ V}, T_A = 150\text{ °C}$	I_{CB0}	— — — —	— — — —	20 20 20 20	nA nA μA μA
Emitter cutoff current $V_{EB} = 4\text{ V}$	I_{EB0}	—	—	20	nA
DC current gain ¹⁾ $I_C = 10\text{ }\mu\text{A}, V_{CE} = 5\text{ V}$ BCW 60 A, BCX 70 G BCW 60 B, BCX 70 H BCW 60 FF, BCW 60 C, BCX 70 J BCW 60 FN, BCW 60 D, BCX 70 K $I_C = 2\text{ mA}, V_{CE} = 5\text{ V}$ BCW 60 A, BCX 70 G BCW 60 B, BCX 70 H BCW 60 FF, BCW 60 C, BCX 70 J BCW 60 FN, BCW 60 D, BCX 70 K $I_C = 50\text{ mA}, V_{CE} = 1\text{ V}$ BCW 60 A, BCX 70 G BCW 60 B, BCX 70 H BCW 60 FF, BCW 60 C, BCX 70 J BCW 60 FN, BCW 60 D, BCX 70 K	h_{FE}	20 20 40 100 120 180 250 380 50 70 90 100	140 200 300 460 170 250 350 500 — — — —	— — — — 220 310 460 630 — — — —	—

¹⁾ Pulse test: $t \leq 300\text{ }\mu\text{s}$, $D \leq 2\%$.

Electrical Characteristics

at $T_A = 25\text{ °C}$, unless otherwise specified.

Parameter	Symbol	Values			Unit
		min.	typ.	max.	

DC characteristics

Collector-emitter saturation voltage ¹⁾ $I_C = 10\text{ mA}$, $I_B = 0.25\text{ mA}$ $I_C = 50\text{ mA}$, $I_B = 1.25\text{ mA}$	V_{CEsat}	–	0.12	0.25	V
		–	0.20	0.55	
Base-emitter saturation voltage ¹⁾ $I_C = 10\text{ mA}$, $I_B = 0.25\text{ mA}$ $I_C = 50\text{ mA}$, $I_B = 1.25\text{ mA}$	V_{BEsat}	–	0.70	0.85	
		–	0.83	1.05	
Base-emitter voltage $I_C = 10\text{ }\mu\text{A}$, $V_{CE} = 5\text{ V}$ $I_C = 2\text{ mA}$, $V_{CE} = 5\text{ V}$ $I_C = 50\text{ mA}$, $V_{CE} = 1\text{ V}$ ¹⁾	$V_{BE(on)}$	–	0.52	–	
		0.55	0.65	0.75	
		–	0.78	–	

AC characteristics

Transition frequency $I_C = 20\text{ mA}$, $V_{CE} = 5\text{ V}$, $f = 100\text{ MHz}$	f_T	–	250	–	MHz
Output capacitance $V_{CB} = 10\text{ V}$, $f = 1\text{ MHz}$	C_{obo}	–	3	–	pF
Input capacitance $V_{EB} = 0.5\text{ V}$, $f = 1\text{ MHz}$	C_{ibo}	–	8	–	
Short-circuit input impedance $I_C = 2\text{ mA}$, $V_{CE} = 5\text{ V}$, $f = 1\text{ kHz}$ BCW 60 A, BCX 70 G BCW 60 B, BCX 70 H BCW 60 FF, BCW 60 C, BCX 70 J BCW 60 FN, BCW 60 D, BCX 70 K	h_{11e}	–	2.7	–	k Ω
		–	3.6	–	
		–	4.5	–	
		–	7.5	–	
Open-circuit reverse voltage transfer ratio $I_C = 2\text{ mA}$, $V_{CE} = 5\text{ V}$, $f = 1\text{ kHz}$ BCW 60 A, BCX 70 G BCW 60 B, BCX 70 H BCW 60 FF, BCW 60 C, BCX 70 J BCW 60 FN, BCW 60 D, BCX 70 K	h_{12e}	–	1.5	–	10^{-4}
		–	2.0	–	
		–	2.0	–	
		–	3.0	–	

¹⁾ Pulse test: $t \leq 300\text{ }\mu\text{s}$, $D \leq 2\%$.

Electrical Characteristics

at $T_A = 25\text{ }^\circ\text{C}$, unless otherwise specified.

Parameter	Symbol	Values			Unit
		min.	typ.	max.	

AC characteristics

Short-circuit forward current transfer ratio $I_C = 2\text{ mA}$, $V_{CE} = 5\text{ V}$, $f = 1\text{ kHz}$ BCW 60 A, BCX 70 G BCW 60 B, BCX 70 H BCW 60 FF, BCW 60 C, BCX 70 J BCW 60 FN, BCW 60 D, BCX 70 K	h_{21e}	–	200	–	–
Open-circuit output admittance $I_C = 2\text{ mA}$, $V_{CE} = 5\text{ V}$, $f = 1\text{ kHz}$ BCW 60 A, BCX 70 G BCW 60 B, BCX 70 H BCW 60 FF, BCW 60 C, BCX 70 J BCW 60 FN, BCW 60 D, BCX 70 K	h_{22e}	–	18	–	μS
Noise figure $I_C = 0.2\text{ mA}$, $V_{CE} = 5\text{ V}$, $R_S = 2\text{ k}\Omega$ $f = 1\text{ kHz}$, $\Delta f = 200\text{ Hz}$ BCW 60 A to BCX 70 K BCW 60 FF, BCW 60 FN	F	–	2	–	dB
Equivalent noise voltage $I_C = 0.2\text{ mA}$, $V_{CE} = 5\text{ V}$, $R_S = 2\text{ k}\Omega$ $f = 10\text{ Hz} \dots 50\text{ Hz}$ BCW 60 FF, BCW 60 FN	V_n	–	–	0.135	μV

Total power dissipation $P_{tot} = f(T_A^*; T_S)$

* Package mounted on epoxy

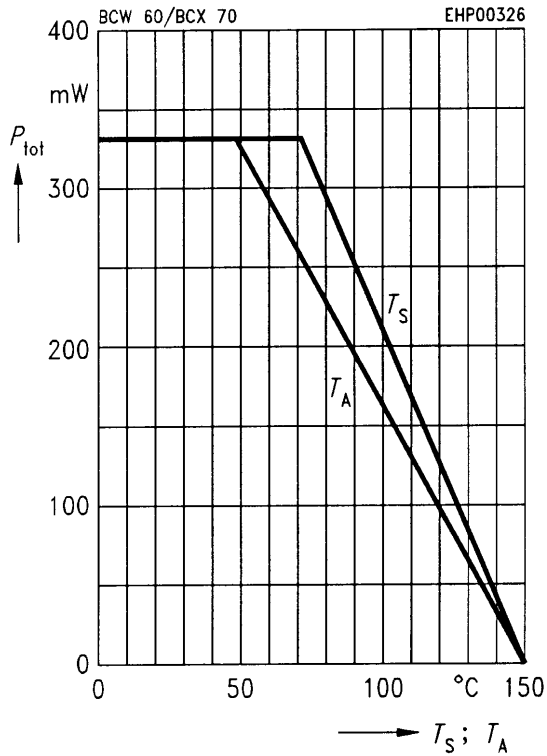

Collector-base capacitance $C_{CB0} = f(V_{CB0})$

Emitter-base capacitance $C_{EB0} = f(V_{EB0})$

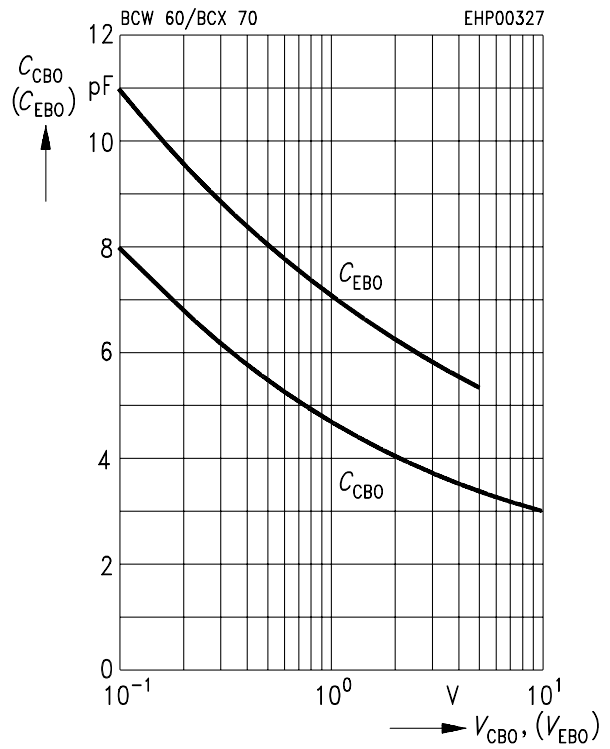

Permissible pulse load $P_{tot max}/P_{tot DC} = f(t_p)$

Transition frequency $f_T = f(I_C)$

$V_{CE} = 5 V$

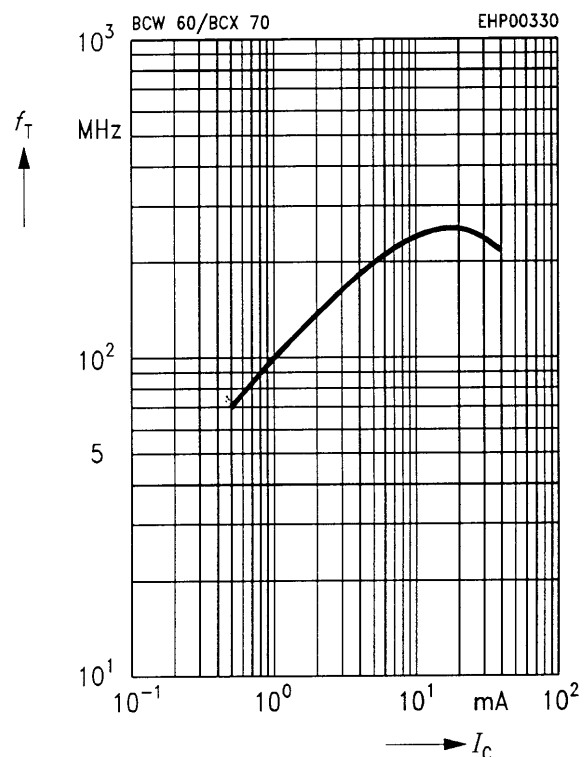
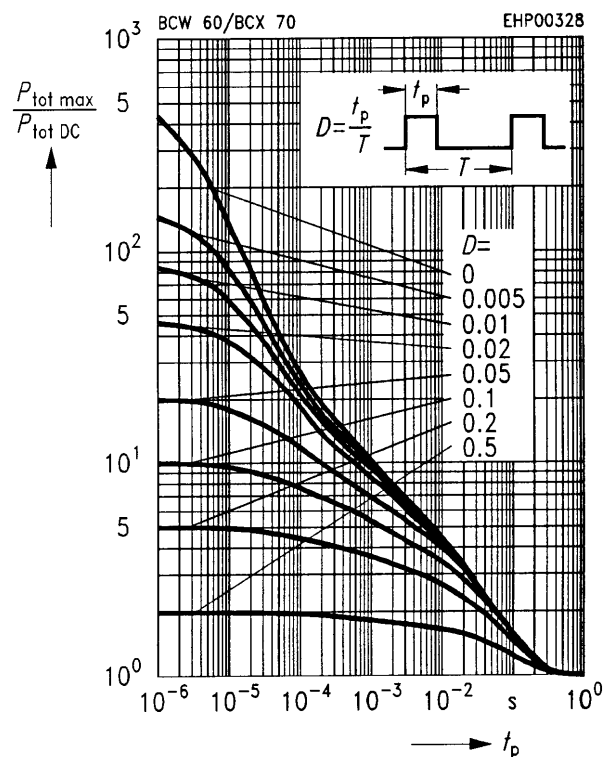

Base-emitter saturation voltage

$I_C = f(V_{BEsat})$

$h_{FE} = 40$

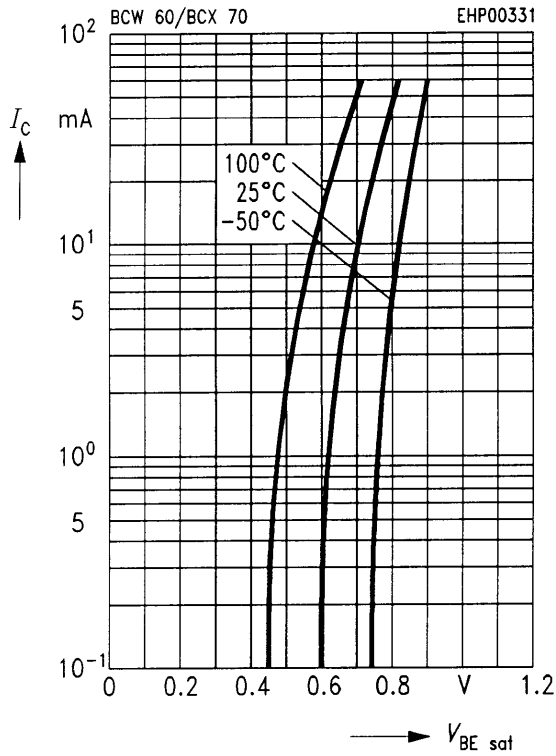

Collector-emitter saturation voltage

$I_C = f(V_{CEsat})$

$h_{FE} = 40$

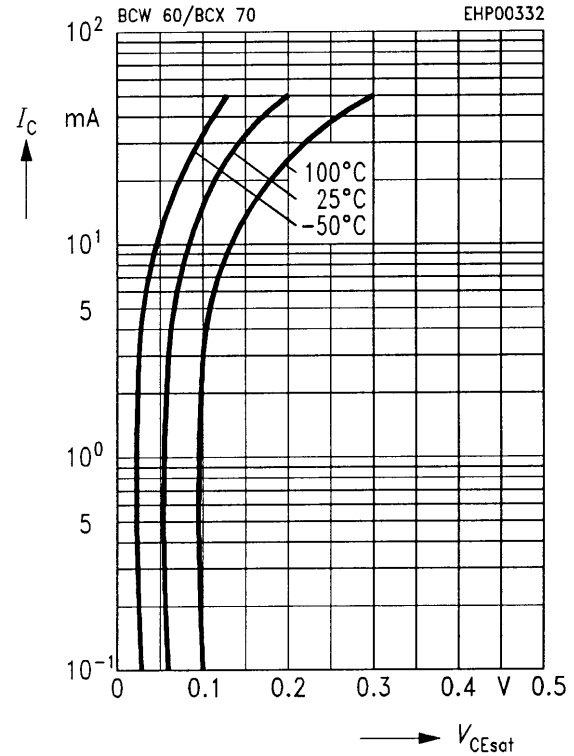

Collector current $I_C = f(V_{BE})$

$V_{CE} = 5 V$

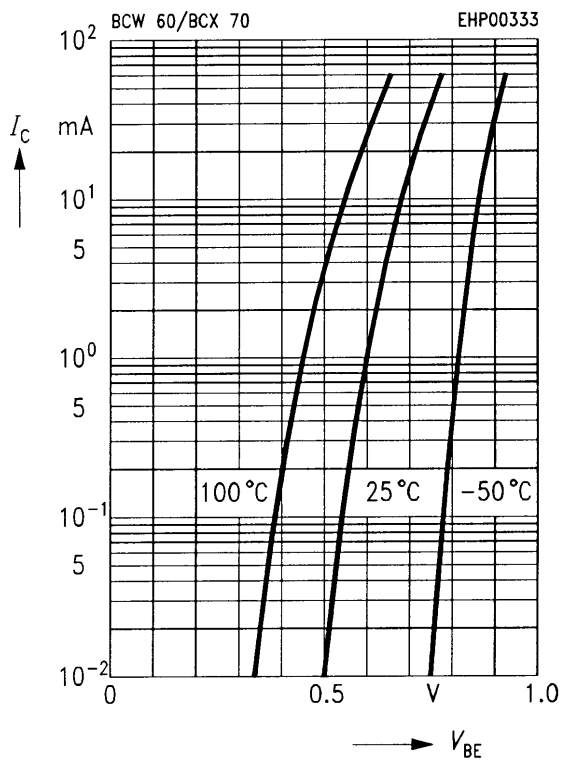

DC current gain $h_{FE} = f(I_C)$

$V_{CE} = 5 V$

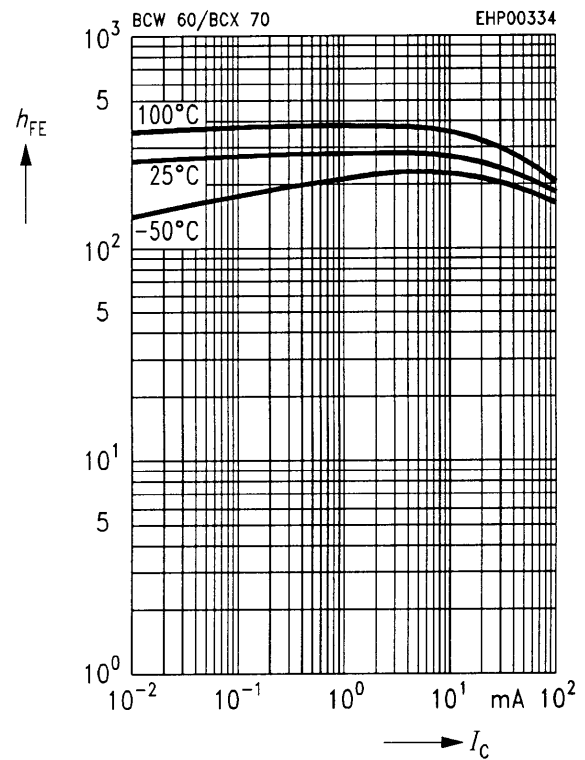

Collector cutoff current $I_{CB0} = f(T_A)$

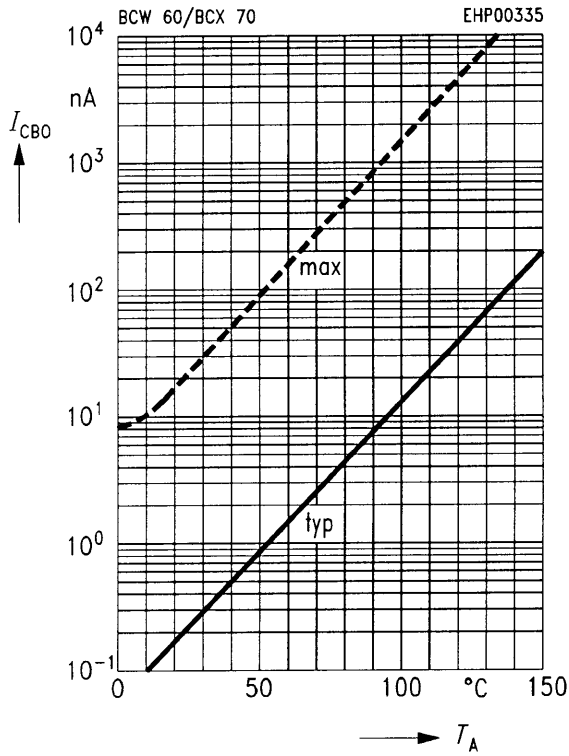

h parameter $h_e = f(I_C)$

$V_{CE} = 5 V$

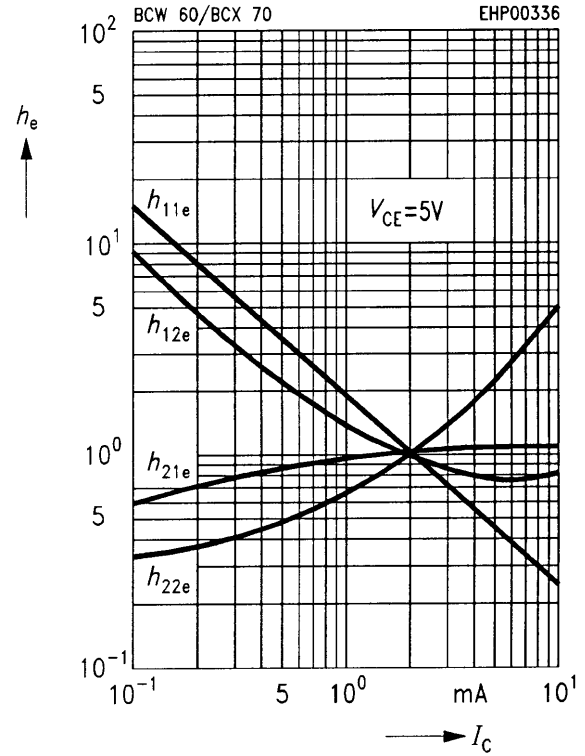

h parameter $h_e = f(V_{CE})$

$I_C = 2 mA$

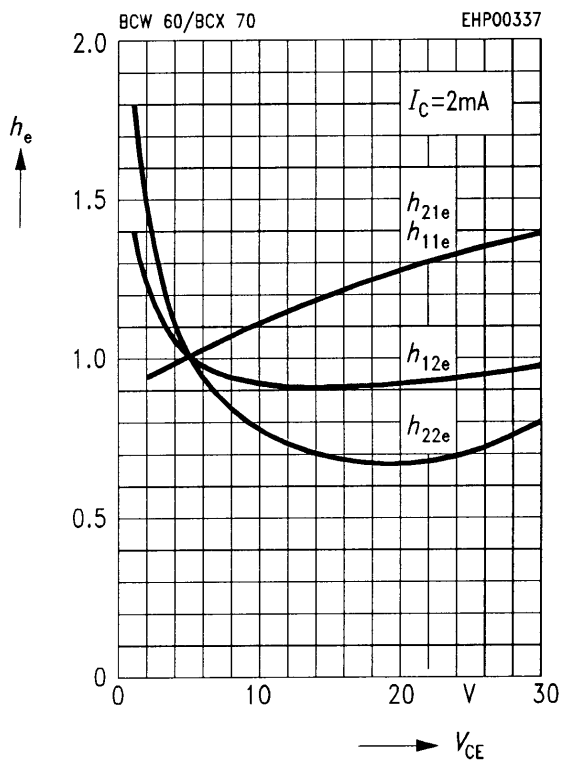

Noise figure $F = f(V_{CE})$

$I_C = 0.2 mA, R_S = 2 k\Omega, f = 1 kHz$

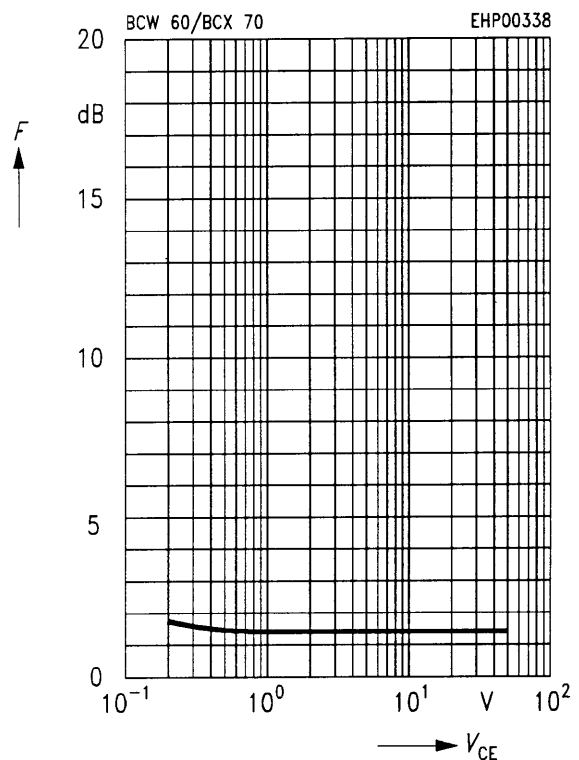

Noise figure $F = f(f)$

$I_C = 0.2 \text{ mA}$, $R_S = 2 \text{ k}\Omega$, $V_{CE} = 5 \text{ V}$

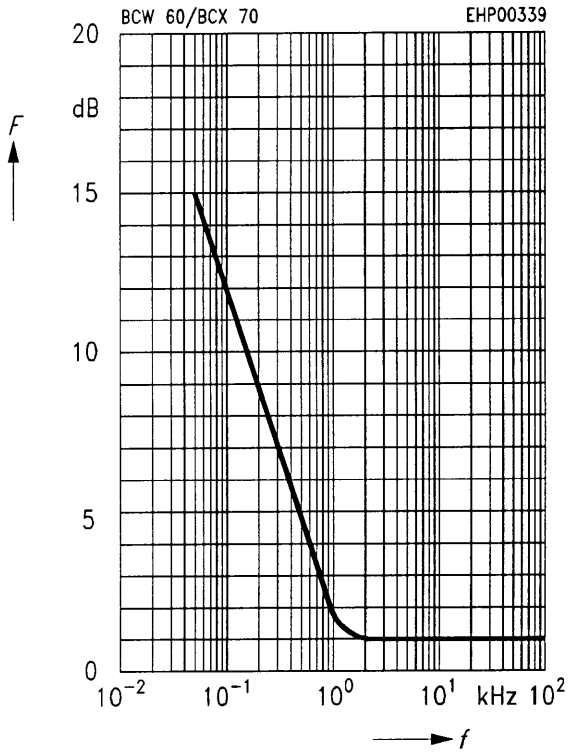

Noise figure $F = f(I_C)$

$V_{CE} = 5 \text{ V}$, $f = 120 \text{ Hz}$

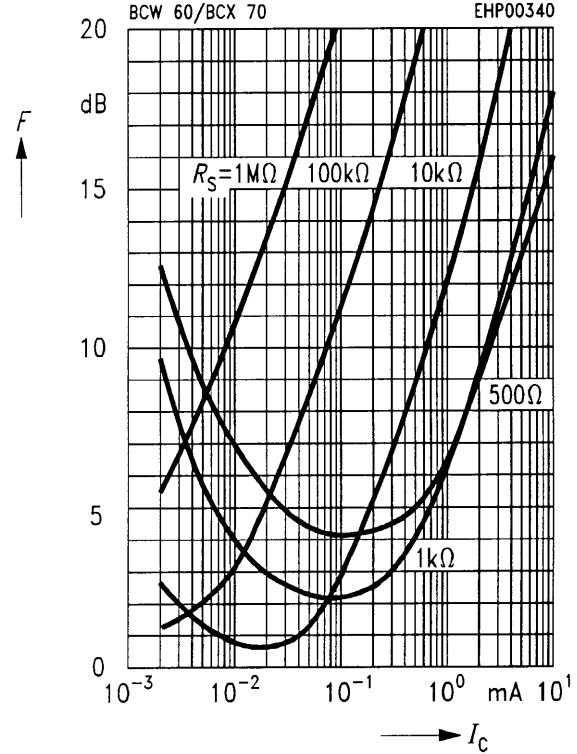

Noise figure $F = f(I_C)$

$V_{CE} = 5 \text{ V}$, $f = 1 \text{ kHz}$

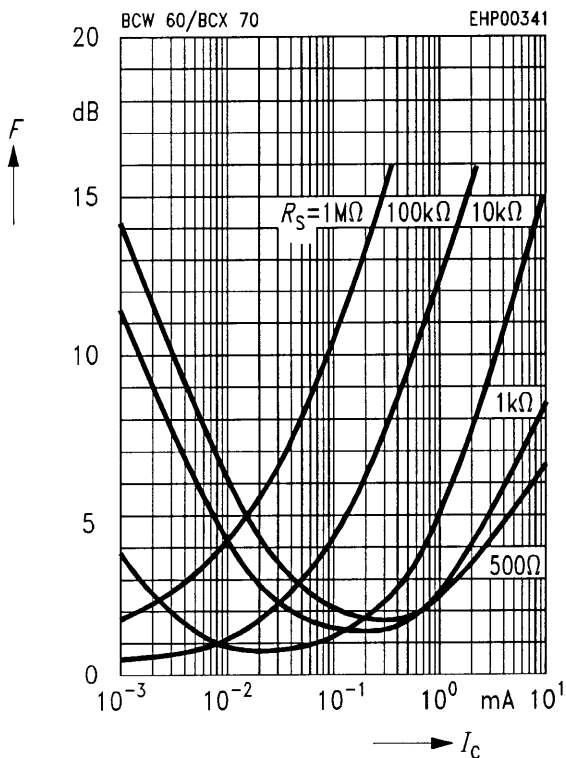

Noise figure $F = f(I_C)$

$V_{CE} = 5 \text{ V}$, $f = 10 \text{ kHz}$

