



# LTH5MM12V Series

## 5mm (T-1 3/4) Through Hole LED

### Built in Resistor for 12VDC



#### LTH5MM12VFR4700 - Yellow Water-Clear T-1 3/4 (5 mm) LED

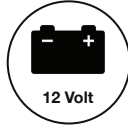

### Applications

- Automotive
- Indoor and Outdoor Indication
- Industrial
- Appliances and Consumer Equipments
- Storage Servers
- Boats
- Railway
- Electronic Devices
- Residential and Landscape Lighting
- Infrastructure

### Key Features

- Made with InGaN (White)
- Through-hole technology
- Integrated resistor for 12VDC operation
- With Flange
- Water-Clear Lens
- LED Bulb Size: 5mm (T-1 3/4), also available in 3mm (T-1)
- RoHS and REACH Compliant
- High-Brightness LED
- Available in 5 colors (red, green, white, blue and yellow)
- Viewing Angle: 16° (red, green, yellow) and 20° (blue, white)
- Moisture Sensitive Level (MSL): 2

## Ordering Data

The LTH5MM12V Series is available in a range of standard features and options. To specify your LED, select one option from each column.

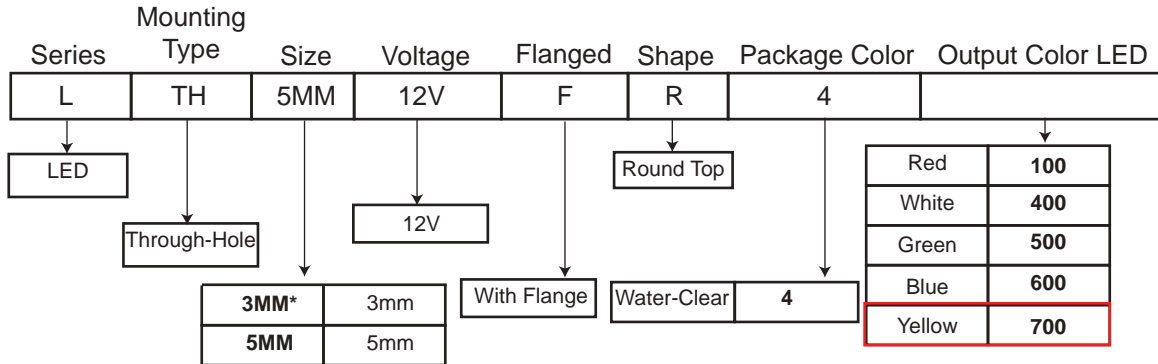

Part Numbers	Color
LTH5MM12VFR4100	Red
LTH5MM12VFR4400	White
LTH5MM12VFR4500	Green
LTH5MM12VFR4600	Blue
LTH5MM12VFR4700	Yellow

\*For 3mm option, please consult LTH3MM12V Series' datasheet

## Product Dimensions

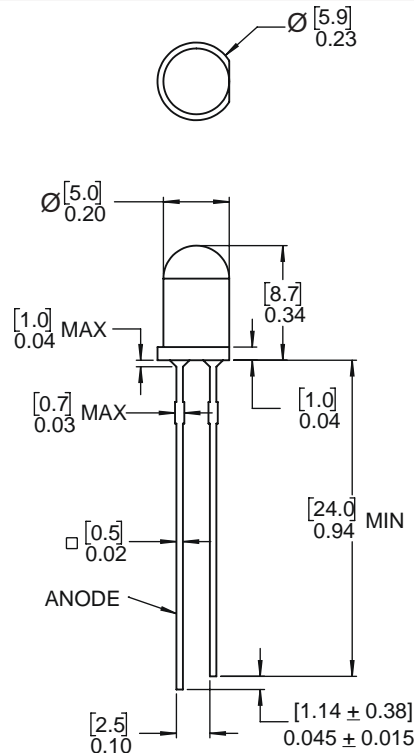

### Notes:

1. All dimensions are in [millimeters] inches.
2. Tolerance is  $\pm [0.25]_{0.01}$  unless otherwise noted.
3. The specifications, characteristics and technical data described in the datasheet are subject to change without prior notice.

## Product Dimensions

### ABSOLUTE MAXIMUM RATINGS

(Ta=25°C)

Parameter	Symbol	Ratings	Unit
Peak Forward Current (duty 1/10 @ 1KHz)	I <sub>FP</sub>	100	mA
Recommended Operating Current	I <sub>F(REC)</sub>	20	mA
Power Dissipation	P <sub>D</sub>	85	mW
Reverse Voltage	V <sub>R</sub>	5	V
Operating Temperature Range	T <sub>OPR</sub>	-40~+85	°C
Storage Temperature Range	T <sub>STG</sub>	-40~+100	°C
Lead Soldering Temperature Range 1.6mm (1/16 inch) from body	T <sub>SOL</sub>	260°C for 5 seconds	

### OPTICAL-ELECTRICAL CHARACTERISTICS

(Ta=25°C)

Parameter	Symbol	Test Condition	Min	Typ	Max	Unit
Luminous Intensity	I <sub>v</sub>	I <sub>F</sub> =12mA	3500	4500	6000	mcd
Peak Emission Wavelength	λ <sub>P</sub>		--	590	--	nm
Dominant Wavelength	λ <sub>D</sub>		588	592	595	nm
Forward Voltage	V <sub>F</sub>		10	12	13	V
Spectral Line Half-Width	Δλ		--	18	--	nm
Viewing Angle	2θ <sub>½</sub>		--	16	--	deg
Reverse Current	I <sub>R</sub>	V <sub>R</sub> =5V	--	--	10	μA

# Product Specifications

## Typical Electrical-Optical Characteristic Curves

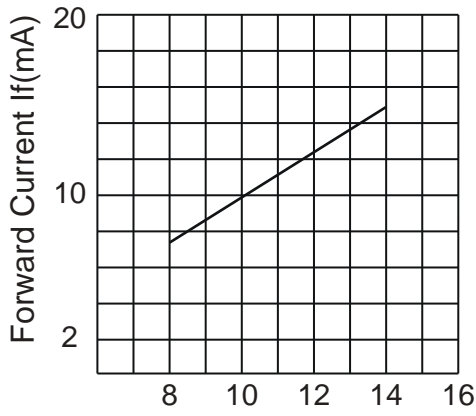

Forward Current vs. Forward Voltage

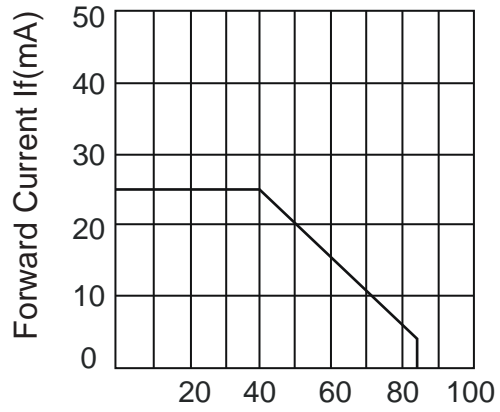

Forward Current Derating Curve

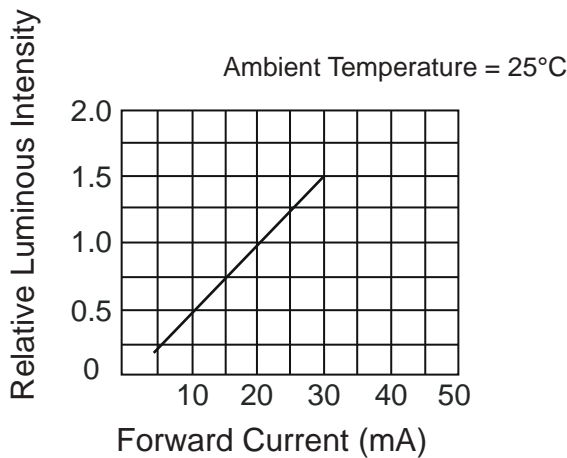

Luminous Intensity vs. Forward Current

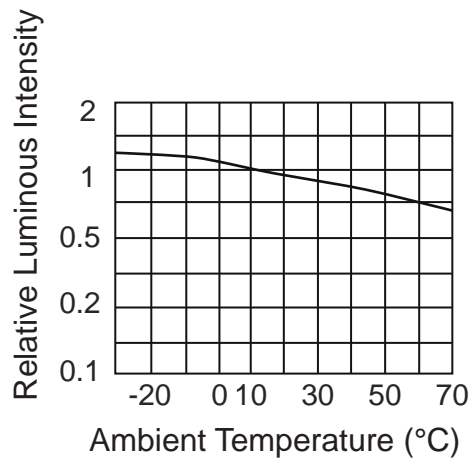

Luminous Intensity vs. Ambient Temperature

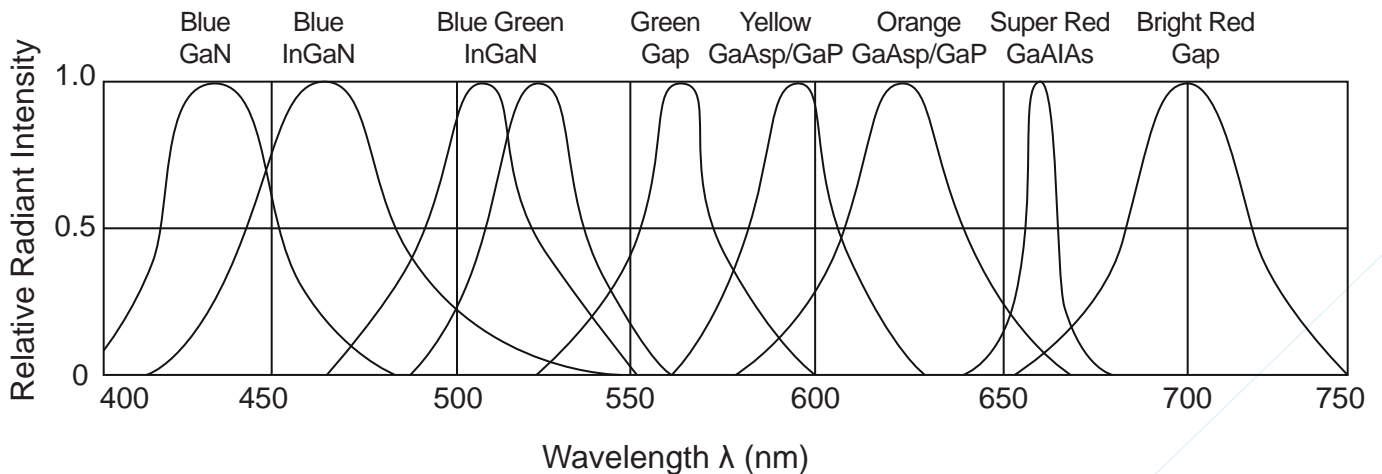

Relative Intensity vs. Wavelength

## Application Notes

### 1. Storage

The Storage Temperature and RH are: 5°C ~ 30°C, RH 60% or less.

We suggest our customers use our products within a year.

If the moisture absorbent material (silica gel) has faded away or the LEDs exceeded the storage time, bake treat more than 24 hours at 60°C ±5°C.

### 2. Electrostatic Discharge (ESD)

Static electricity or surge voltage will damage the LEDs.

Recommendations: Use a conductive wrist band or anti-electrostatic glove when handling these LEDs. All devices, equipment and machinery must be properly grounded.

Work tables, storage racks, etc. should be properly grounded. In the event of a manual working in process, make sure the devices are well protected from ESD at any time.

### 3. Recommended Soldering Condition

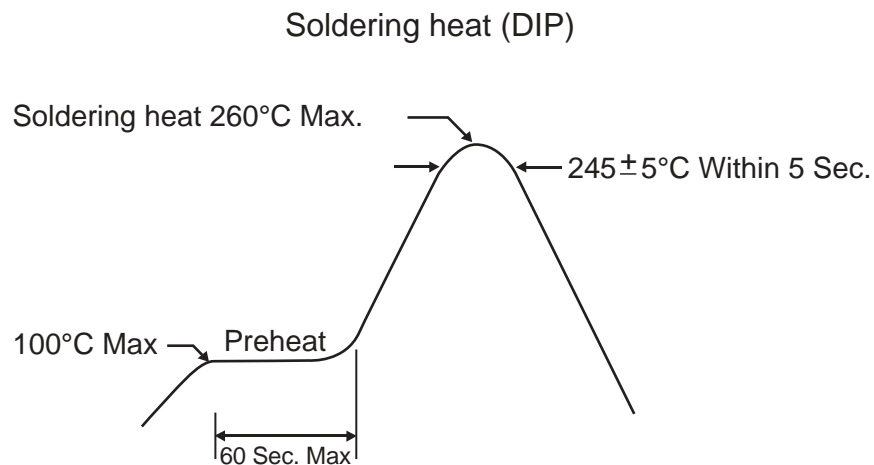

Temperature at tip of soldering iron: 350°C Max

Soldering time: 3 sec ±1 sec (once only)

## Application Notes

### 4. Reflow Profile

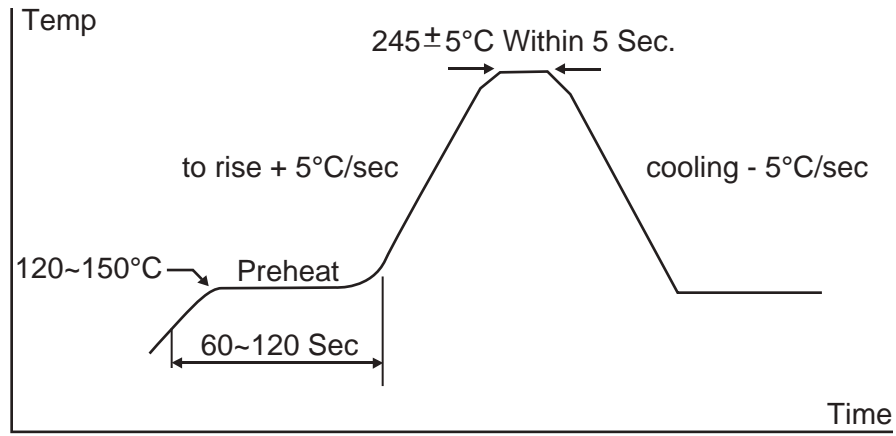

## Compliances and Approvals

