

Power Relay G2A

Highly Reliable, 4-pole Miniature Relay Ideal for Sequence Control

- Card lift-off employed for greater life and stable quality.
- Long endurance and stable quality are assured by card lift-off system.
- Mounting interchangeability with MY-series Relays.
- Operation indicator mechanism incorporated for at-a-glance monitoring of ON/OFF operation. In addition, a built-in operation indicator model is also included in this Relay Series.



Ordering Information

Classification		Plug-in terminals/Solder terminals	PCB terminals
Standard model		G2A-432A	G2A-4321P
Arc barrier equipped model		G2A-432AY	---
Built-in diode model		G2A-432A-D	G2A-4321P-D
Built-in operation indicator model		G2A-432A-N	---
Built-in operation indicator and diode model		G2A-432A-N1	---
UL-approved model	Standard model	G2A-432A-US	G2A-4321P-US
	Arc barrier equipped model	G2A-432AY-US	---

- Note:**
1. When placing your order, add the coil voltage rating listed in the specifications to the model number as shown below.
Example: G2A-432A 100/110 VAC
Rated coil voltage
 2. Built-in diode model and the operating coil of the G2A-432A-N1 are available only with DC ratings.
 3. The Latching Relay (G2AK) and Fully sealed Relay (G2A-434A) developed based on the G2A are also available in this series.

Model Number Legend

G2A-□□□□□□-□
1 2 3 4 5 6

1. Number of Poles and Contact Form

4: 4PDT

2. Contact Type

3: Crossbar bifurcated

3. Enclosure Construction

2: Casing

4. Terminal Shape

A: Plug-in

1P: PCB

5. Safety Breaking Mechanism

None: No

Y: Arc barrier

6. Special Element

None: Standard

D: Built-in diode

N: Built-in operation indicator

N1: Built-in operation indicator and diode

US: UL-approved

- Note:**
1. The coil of the G2A-432A-N1 or a built-in diode model operates with DC only.
 2. The G2A Series include the G2A-434A Power Relay and G2AK Latching Relay. Refer to G2A-434 and G2AK for details.
 3. Built-in indicator models satisfying international standards are available. Contact your OMRON representative for details.

■ Relays Other than Standard Models

Arc barrier equipped	Built-in diode	Built-in operation indicator
G2A-432AY	G2A-432A-D	G2A-432A-N
The arc barrier equipped model is a relay designed to prevent arc short-circuiting between phases and can be used in a circuit which has potential difference between phases. The switching power of such a circuit with potential difference must be limited to less than 1/2 the rated load when using this Relay.	The built-in diode model is a relay which incorporates a diode for absorption of the reverse voltage that may be generated when the coil is de-energized. Because the release time of this model is longer than the standard model, pay adequate attention to this point in designing a circuit. Also, pay attention to the + polarity of the coil. The reverse-breakdown voltage of the diode is 1,000 V.	The built-in operation indicator model has a newly added operation indicator to the conventional operation indication mechanism and facilitates operation monitoring without being affected by ambient illumination. With the -N model (rated at 16, 12, 24, and 48 VDC) and -N1 model rated at 6, 12, 24, 48, and 100 VDC), pay attention to the + polarity of the coil.

■ Accessories

Sockets

Track mounting Screw terminals	Front-connecting Socket	Solder terminals		Wire-wrap terminals		PCB terminals
		Without Hold-down Clip	With Hold-down Clip	Without Hold-down Clip	With Hold-down Clip	
PYF14A	PYF14(-E), PYF14A-TU, PYF14T	PY14, PY14-3 (see note)	PY14-Y2	PY14QN(2)	PY14QN(2)-Y2	PY14-0, PY14-02

Note: With monitor terminal.

Relay Hold-down Clips

For Front-connecting Socket	PYC-A2
For Back-connecting Socket	PYC-3/PYC-5
For Socket Mounting Plate	PYC-2

Socket Mounting Plates

For one Socket	PYP-1
For 18 Sockets	PYP-18
For 36 Sockets	PYP-38

Specifications

■ Coil Ratings

The rated currents for some of the built-in operation indicator models differ from the values given in this table. Refer to note 5 below.

Rated voltage	Rated current		Coil resistance	Coil inductance (ref. value)		Must operate	Must release	Max. voltage	Power consumption
	50 Hz	60 Hz		Armature OFF	Armature ON				
6 VAC	295 mA	233 mA	8.9 Ω	0.048 H	0.065 H	80 % max.	30 % min.	110 %	Approx. 1.4 VA
12 VAC	148 mA	117 mA	34 Ω	0.166 H	0.257 H				
24 VAC	73 mA	58 mA	136 Ω	0.691 H	1.04 H				
50 VAC	35 mA	28 mA	530 Ω	3.08 H	4.53 H				
100/ 110 VAC	17.7/ 21.4 mA	14/ 16.8 mA	2,200 Ω	12.42/ 12.38 H	18/16.4 H				
200/ 220 VAC	8.9/ 10.8 mA	7/8.4 mA	8,800 Ω	42.2/ 41.8 H	72/65.5 H				
6 VDC	176 mA		34 Ω	0.14 H	0.26 H	10 % min.	110 %	Approx. 1.1 W	
12 VDC	88 mA		136 Ω	0.6 H	1.0 H				
24 VDC	45 mA		530 Ω	2.7 H	4.6 H				
48 VDC	22 mA		2,200 Ω	11 H	19 H				
100 VDC	11.4 mA		8,800 Ω	43 H	73 H				

Note: 1. The rated current and coil resistance are measured at a coil temperature of 23°C with tolerances of +15%/-20% for AC rated current and ±15% for DC coil resistance.

- The AC coil resistance and coil inductance values are for reference only.
- Performance characteristic data is measured at a coil temperature of 23°C.
- The maximum voltage is one that is applicable instantaneously to the Relay coil at an ambient temperature of 23°C and not continuously.
- For built-in operation indicator models rated at 6, 12, and 24 VDC, add an LED current of approx. 5 mA to the rated currents.

■ Contact Ratings

Load	Resistive load ($\cos\phi = 1$)	Inductive load ($\cos\phi = 0.4$) (L/R = 7 ms)
Contact type	Crossbar bifurcated	
Contact material	Movable: AgAu-clad AgPd Fixed: AgPd	
Rated load	0.3 A at 110 VAC 0.5 A at 24 VDC	0.2 A at 110 VAC 0.3 A at 24 VDC
Rated carry current	3 A	
Max. switching power	250 VAC, 125 VDC	

■ Characteristics

Classification	Standard/Acr barrier equipped/Built-in operation indicator models (G2A-□-N)	Built-in diode/Built-in operation indicator models (G2A-□-N1)
Contact resistance (see note 2)	100 mΩ max.	
Operate time (see note 3)	15 ms max.	
Release time (see note 3)	15 ms max.	30 ms max.
Max. operating frequency	Mechanical: 18,000 operations/hour Electrical: 1,800 operations/hour (under rated load)	
Insulation resistance (see note 4)	100 MΩ min. (at 500 VDC)	
Dielectric strength	1,500 VAC, 50/60 Hz for 1 min between coil and contacts and contacts of different polarities (700 VAC between contacts of same polarity)	
Vibration resistance	Destruction: 10 to 55 to 10 Hz, 0.75 mm single amplitude (1.5 mm double amplitude) Malfunction: 10 to 55 to 10 Hz, 0.5 mm single amplitude (1.0 mm double amplitude)	
Shock resistance	Destruction: 1,000 m/s ² Malfunction: 100 m/s ²	
Error rate (level P) (Reference value) (see note 6)	1 mA at 100 mVDC	
Endurance	Mechanical: 100,000,000 operations min. (at operating frequency of 18,000 operations/hour) Electrical: 5,000,000 operations min. (under rated load and at operating frequency of 1,800 operations/hour) (see note 5)	
Ambient temperature	Operating: -10°C to 40°C (with no icing or condensation)	
Ambient humidity	Operating: 5% to 85%	
Weight	Approx. 38 g	

Note: 1. The data shown above are initial values.

2. The contact resistance was measured with 0.1 A at 5 VDC using the voltage drop method.

3. The operate or release time was measured with the rated voltage imposed with any contact bounce ignored at an ambient temperature of 23°C.

4. The insulation resistance was measured with a 500-VDC megger applied to the same places as those used for checking the dielectric strength.

5. The electrical endurance was measured at an ambient temperature of 23°C.

6. This value was measured at a switching frequency of 60 operations per minute.

■ Approved by Standards

UL508 (File No. E41515)

Model	Coil ratings	Contact ratings
G2A-□-US	6 to 120 VAC 6 to 120 VDC	1 A 120 VAC (resistive load) 1 A 30 VDC (inductive load)

Engineering Data

Maximum Switching Power

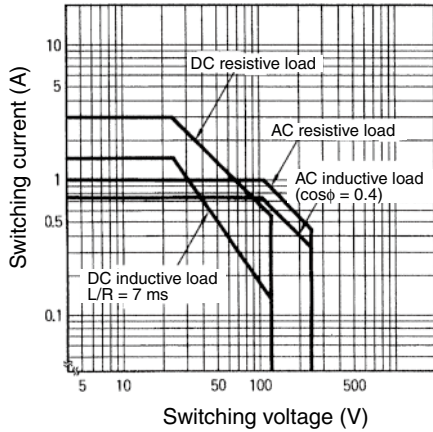

Endurance

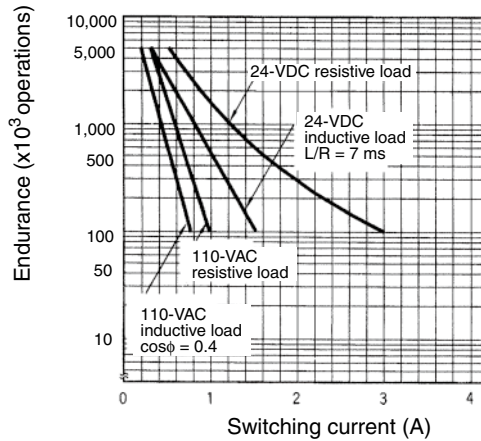

Ambient Temperature vs. Must-operate and Must-release Voltage

G2A AC (60 Hz)

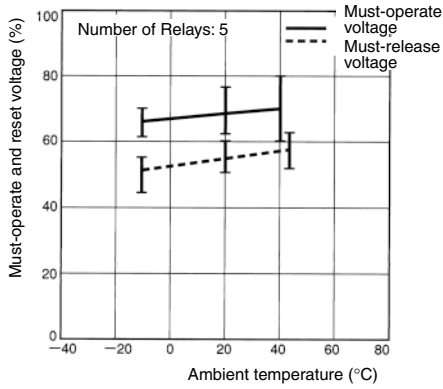

Ambient Temperature vs. Coil Temperature Rise

G2A 110 VAC (50 Hz)

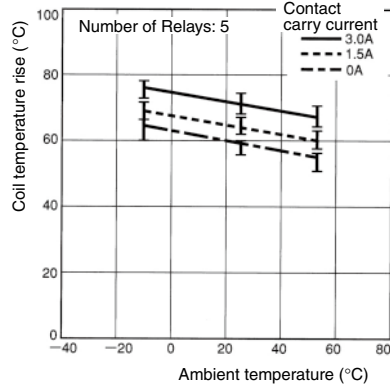

Malfunctioning Shock

G2A-432A 100/110 VAC

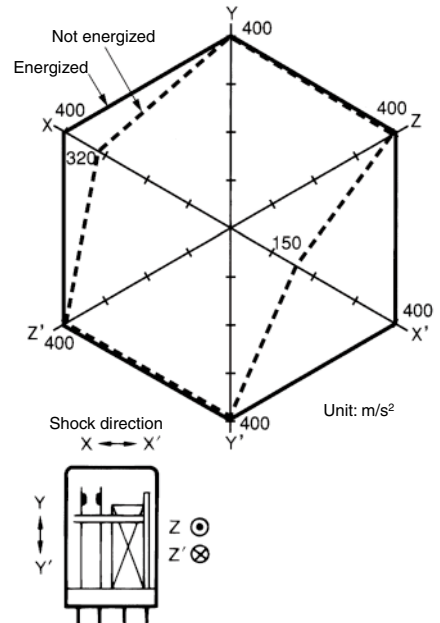

Number of samples = 5

Measurement conditions: Impose a shock of 100 m/s² in the ±X, ±Y, and ±Z directions three times each with the Relay energized and not energized to check the shock values that cause the Relay to malfunction.

G2A DC

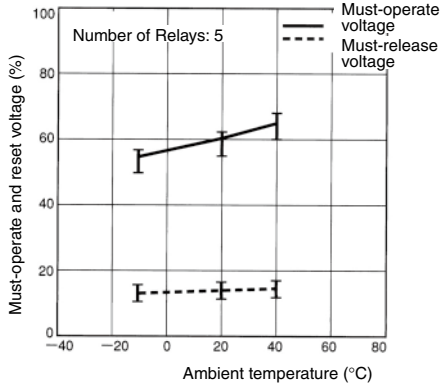

G2A DC

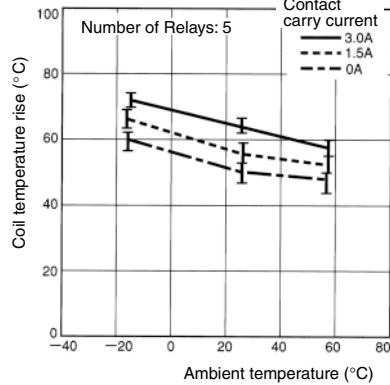

**Contact Reliability
(JIS C 4530 Allen-Bradley Test Circuit)**

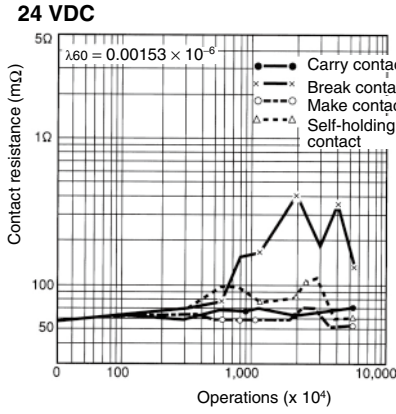
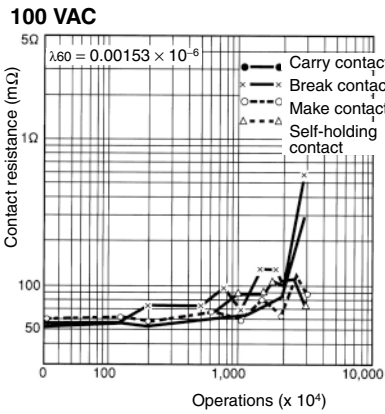

**Contact Reliability
(Improved Allen-Bradley Test Circuit)**

Contact load: 1 mA at 5 VDC (resistive load)
Failure criterion contact resistance: 100 Ω

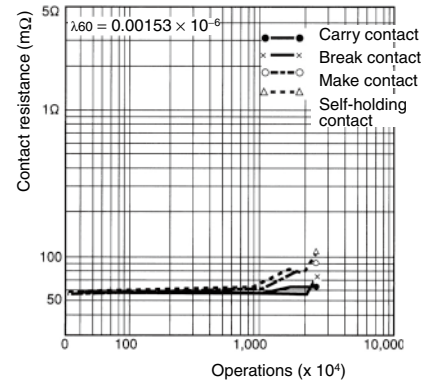

Coil Self-load Life Curve

(Unit: mA)

Model	Specifications	No. of Relays				
		1	2	3	5	10
G2A-432A	100 VAC, 60 Hz	14	28	42	70	140
	24 VDC	45	90	135	225	450

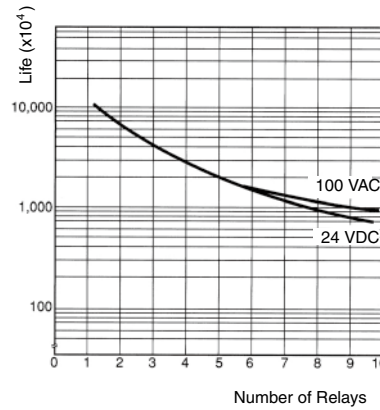

**Relay Mounting Adjacent Distance vs. Coil Temperature Rise
G2A-432A 24 VDC**

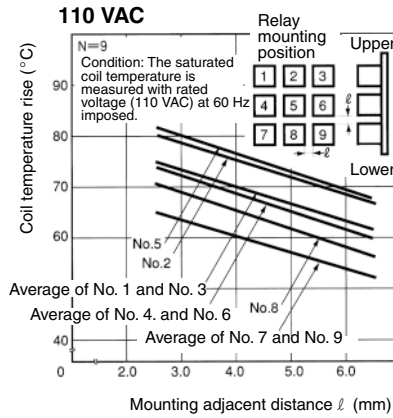
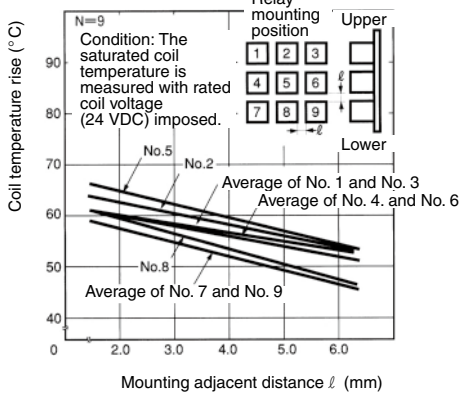

Accessories (Order Separately)

Connecting Sockets

Front-connecting Socket	Back-connecting Socket					
	DIN track/screw mounting	Solder terminals		Wire-wrap terminals		PCB terminals
PYF14A(-E) PYF14A-TU PYF14T	PY14 PY14-Y3	PY14-Y2 (with Relay Hold-down Clip)	PY14QN(2)	PY14QN(2)-Y2 (with Relay Hold-down Clip)	PY14-0	PY14-02

- Note:**
1. The PYF□A-TU is a high-humidity relay with nickel-plated rustproof terminal screws that are the same as the PYF□A in size.
 2. The PYF14T is slightly different from the PYF14A(-TU) in shape and size.
 3. The PYF□A-E is a finger-protection model, for which round terminals are not available. Use fork-shaped terminals or equivalent ones instead.

PY14-3 Back-connecting Socket (with check terminals for operation monitoring)

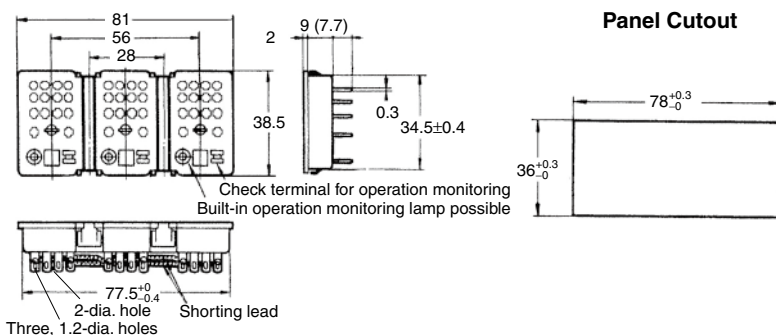
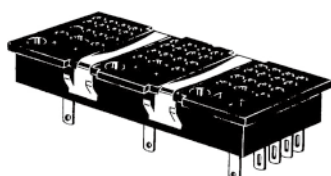

Relay Mounting Height with Socket

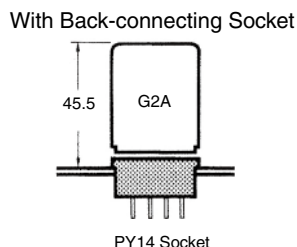
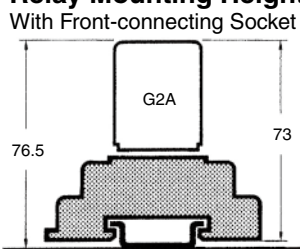

PYF14A
Note: PYF14A can be used for both DIN track mounting and screw mounting.

Relay Hold-down Clips

For Front-connecting Socket	For Back-connecting Socket		For Socket mounting plate
PYC-A2 	PYC-3 	PYC-5 	PYC-2

Note: When using a Relay Hold-down Clip for the built-in operation indicator model, use of the PYC-A2 or PYC-5, which allows easy viewing of the indicator, is recommended.

Dimensions

Note: 1. All units are in millimeters unless otherwise indicated.
 2. Dimensional tolerances are ± 0.1 mm.

Solder Terminal Models

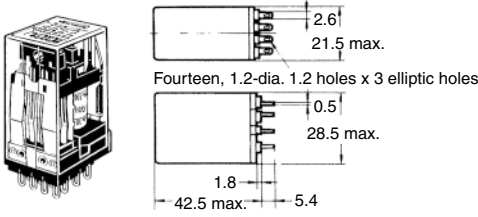

PCB Terminal Models

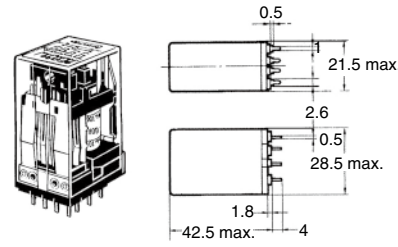

Mounting Holes on PCB (Bottom View)

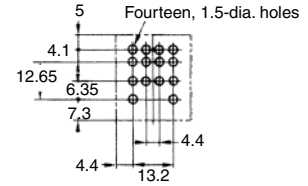

Terminal Arrangement/Internal Connections (Bottom View)

Standard Models

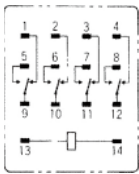

Make-before-break Contact Models

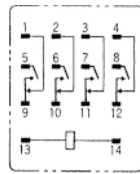

Arc Barrier Equipped Models

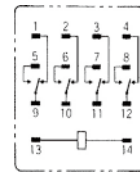

Built-in Diode Models

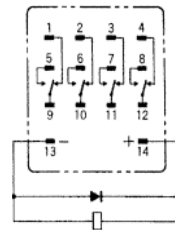

Built-in Operation Indicator Models

Color of operation indicator
 AC model: Red
 DC model: Green

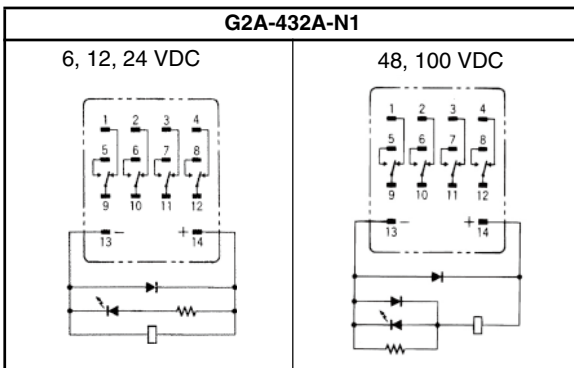
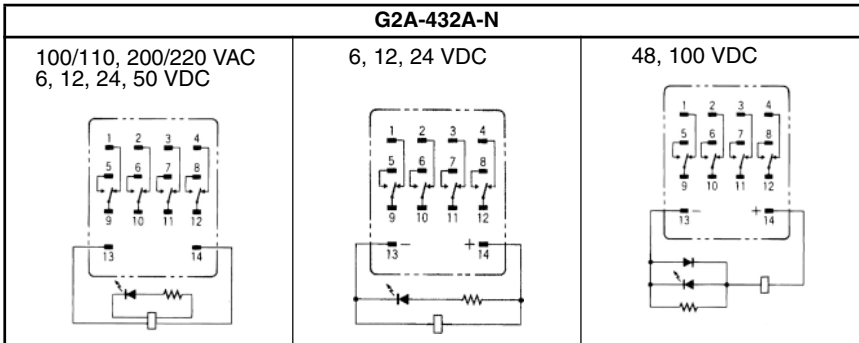

Note: Do not reverse the polarity of the coil of DC Relays that have a built-in indicator or diode.

Socket Mounting Plates (t = 1.6 mm)

Use any of these plates when mounting two or more Sockets side-by-side

PYP-1 (for Single Socket Mounting)

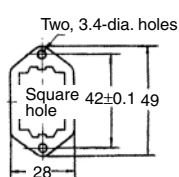

PYP-18 (for Mounting 18 Sockets)

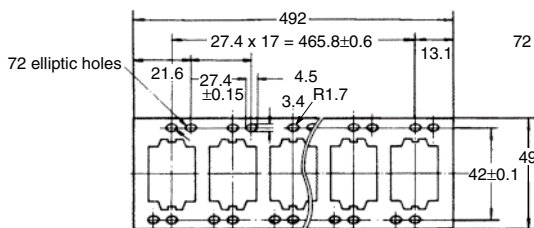

Note: PYP-18 and PYP-36 can be cut to a desired length for mounting less than 18 or 36 Sockets, respectively.

PYP-36 (for Mounting 36 Sockets)

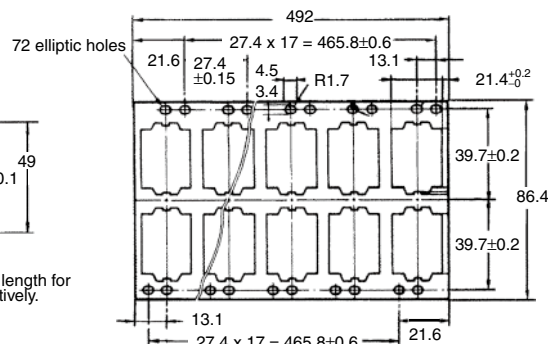

Safety Precautions

Refer to *Safety Precautions for All Relays*.

A DC coil model with a built-in indicator or built-in diode has coil polarity. Be sure to wire the terminals correctly, otherwise the diode may be broken or the operating indicator may not be lit. Furthermore, as a result of the short-circuiting of the built-in diode, the devices in the circuit may be damaged.

ALL DIMENSIONS SHOWN ARE IN MILLIMETERS.

To convert millimeters into inches, multiply by 0.03937. To convert grams into ounces, multiply by 0.03527.

In the interest of product improvement, specifications are subject to change without notice.

Safety Precautions for All Relays

Refer to the *Safety Precautions* section for each Relay for specific precautions applicable to that Relay.

■ Precautions for Safe Use

Observe the following precautions to ensure safety.

- Do not touch the terminal section (charged section) of the Relay or Socket while power is being supplied. Electric shock may occur.
- Never use a Relay for a load that exceeds the contact ratings of the Relay, such as the switching capacity. Doing so may result in reducing Relay performance for insulation failure, contact welding, and contact faults, and might even result in burning or other damage to the Relay itself.
- Do not drop the Relay or dismantle it. Doing so may reduce Relay performance and might even result in burning or other damage to the Relay itself.
- Relay durability is greatly affected by the switching conditions. Always test the Relay under actual application conditions to confirm applicability and use the Relay only for the number of switching operations that will not affect performance. Continued application of a Relay with reduced performance may result in insulation failure between circuits or in burning in the Relay itself.
- Do not apply an overvoltage or incorrect voltage to the coil, and do not wire the terminals incorrectly. Incorrect application may prevent the Relay from performing its designed function, may affect external circuits, and may even result in burning or other damage to the Relay itself.
- Do not use the Relay in atmospheres containing inflammable or explosive gases. Switching arcs or Relay heating may result in fire or explosion.
- Wire the Relay correctly according to the *Precautions for Correct Use* when performing wiring or soldering. If the Relay is used with wiring or soldering that is defective, abnormal heating while power is supplied may result in burning.

Relay Application

- Before actually using the Relay, perform all possible tests to confirm applicability. Unexpected trouble can occur in actual operation that would not be anticipated in theoretical planning.
- Unless otherwise specified, all ratings and performances given in this catalog are for JIS C5442 standard test conditions (temperature: 15 to 35°C, humidity: 25% to 75%, pressure: 86 to 106 kPa). When testing the Relay in the actual application, use the operating environment that will exist in actual applications along with the actual load conditions.
- All reference data provided in this catalog are from measurement samples taken from production lines and represented in graph form. Actual values will depend on the application.
- All ratings and performances given in this catalog are from independent tests. Values will vary for different combinations of ratings and performances.

■ Precautions for Correct Use

Refer to *Technical Guide for General-purpose Relays*.

In the interest of product improvement, specifications are subject to change without notice.

Read and Understand This Catalog

Please read and understand this catalog before purchasing the products. Please consult your OMRON representative if you have any questions or comments.

Warranty and Limitations of Liability

WARRANTY

OMRON's exclusive warranty is that the products are free from defects in materials and workmanship for a period of one year (or other period if specified) from date of sale by OMRON.

OMRON MAKES NO WARRANTY OR REPRESENTATION, EXPRESS OR IMPLIED, REGARDING NON-INFRINGEMENT, MERCHANTABILITY, OR FITNESS FOR PARTICULAR PURPOSE OF THE PRODUCTS. ANY BUYER OR USER ACKNOWLEDGES THAT THE BUYER OR USER ALONE HAS DETERMINED THAT THE PRODUCTS WILL SUITABLY MEET THE REQUIREMENTS OF THEIR INTENDED USE. OMRON DISCLAIMS ALL OTHER WARRANTIES, EXPRESS OR IMPLIED.

LIMITATIONS OF LIABILITY

OMRON SHALL NOT BE RESPONSIBLE FOR SPECIAL, INDIRECT, OR CONSEQUENTIAL DAMAGES, LOSS OF PROFITS, OR COMMERCIAL LOSS IN ANY WAY CONNECTED WITH THE PRODUCTS, WHETHER SUCH CLAIM IS BASED ON CONTRACT, WARRANTY, NEGLIGENCE, OR STRICT LIABILITY.

In no event shall responsibility of OMRON for any act exceed the individual price of the product on which liability is asserted.

IN NO EVENT SHALL OMRON BE RESPONSIBLE FOR WARRANTY, REPAIR, OR OTHER CLAIMS REGARDING THE PRODUCTS UNLESS OMRON'S ANALYSIS CONFIRMS THAT THE PRODUCTS WERE PROPERLY HANDLED, STORED, INSTALLED, AND MAINTAINED AND NOT SUBJECT TO CONTAMINATION, ABUSE, MISUSE, OR INAPPROPRIATE MODIFICATION OR REPAIR.

Application Considerations

SUITABILITY FOR USE

OMRON shall not be responsible for conformity with any standards, codes, or regulations that apply to the combination of products in the customer's application or use of the product.

At the customer's request, OMRON will provide applicable third party certification documents identifying ratings and limitations of use that apply to the products. This information by itself is not sufficient for a complete determination of the suitability of the products in combination with the end product, machine, system, or other application or use.

The following are some examples of applications for which particular attention must be given. This is not intended to be an exhaustive list of all possible uses of the products, nor is it intended to imply that the uses listed may be suitable for the products:

- Outdoor use, uses involving potential chemical contamination or electrical interference, or conditions or uses not described in this catalog.
- Nuclear energy control systems, combustion systems, railroad systems, aviation systems, medical equipment, amusement machines, vehicles, safety equipment, and installations subject to separate industry or government regulations.
- Systems, machines, and equipment that could present a risk to life or property.

Please know and observe all prohibitions of use applicable to the products.

NEVER USE THE PRODUCTS FOR AN APPLICATION INVOLVING SERIOUS RISK TO LIFE OR PROPERTY WITHOUT ENSURING THAT THE SYSTEM AS A WHOLE HAS BEEN DESIGNED TO ADDRESS THE RISKS, AND THAT THE OMRON PRODUCT IS PROPERLY RATED AND INSTALLED FOR THE INTENDED USE WITHIN THE OVERALL EQUIPMENT OR SYSTEM.

Disclaimers

CHANGE IN SPECIFICATIONS

Product specifications and accessories may be changed at any time based on improvements and other reasons.

It is our practice to change model numbers when published ratings or features are changed, or when significant construction changes are made. However, some specifications of the product may be changed without any notice. When in doubt, special model numbers may be assigned to fix or establish key specifications for your application on your request. Please consult with your OMRON representative at any time to confirm actual specifications of purchased product.

DIMENSIONS AND WEIGHTS

Dimensions and weights are nominal and are not to be used for manufacturing purposes, even when tolerances are shown.

ERRORS AND OMISSIONS

The information in this catalog has been carefully checked and is believed to be accurate; however, no responsibility is assumed for clerical, typographical, or proofreading errors, or omissions.

PERFORMANCE DATA

Performance data given in this catalog is provided as a guide for the user in determining suitability and does not constitute a warranty. It may represent the result of OMRON's test conditions, and the users must correlate it to actual application requirements. Actual performance is subject to the OMRON Warranty and Limitations of Liability.

PROGRAMMABLE PRODUCTS

OMRON shall not be responsible for the user's programming of a programmable product, or any consequence thereof.

COPYRIGHT AND COPY PERMISSION

This catalog shall not be copied for sales or promotions without permission.

This catalog is protected by copyright and is intended solely for use in conjunction with the product. Please notify us before copying or reproducing this catalog in any manner, for any other purpose. If copying or transmitting this catalog to another, please copy or transmit it in its entirety.