



MIC2846A

High Efficiency 6 Channel Linear WLED Driver with DAM™, Digital Control and Dual Low I_Q LDOs

General Description

The MIC2846A is a high efficiency White LED (WLED) driver featuring two low quiescent current LDOs. It is designed to drive up to six LEDs and greatly extend battery life for portable display backlighting and keypad backlighting in mobile devices. The MIC2846A architecture provides the highest possible efficiency by eliminating switching losses present in traditional charge pumps or inductive boost circuits. With a typical dropout of 40mV at 20mA, the MIC2846A allows the LEDs to be driven directly from the battery eliminating switching noise and losses present with the use of boost circuitry.

The MIC2846A features Dynamic Averaged Matching™ (DAM™) which is specifically designed to get the optimum matching despite process variations. This ensures a typical matching of $\pm 1.5\%$ between all six LED channels. The LED brightness is preset by an external resistor and can be dimmed using a single-wire digital control. The digital interface takes commands from digital programming pulses to change the brightness in a logarithmic scale similar to the eye's perception of brightness. The single-wire digital brightness control is divided into two modes of operation; full brightness mode or battery saving mode for a total of 49 brightness steps.

The MIC2846A also features two independently enabled low quiescent current LDOs. Each LDO offers $\pm 3\%$ accuracy over temperature, low dropout voltage (150mV @ 150mA), and low ground current under all load conditions (typically 35 μ A). Both LDOs can be turned off to draw virtually no current.

The MIC2846A is available in the 2.5mm x 2.5mm 14-pin Thin MLF® leadless package with a junction temperature range of -40°C to +125°C

Datasheet and support documentation can be found on Micrel's web site at: www.micrel.com.

Features

WLED Driver

- High Efficiency (no Voltage Boost losses)
- Dynamic Average Matching™ (DAM™)
- Single wire digital control
- Input voltage range: 3.0V to 5.5V
- Dropout of 40mV at 20mA
- Matching better than $\pm 1.5\%$ (typical)
- Current accuracy better than $\pm 1.5\%$ (typical)
- Maintains proper regulation regardless of how many channels are utilized

LDOs

- Very low ground current – Typical 35 μ A
- Stable with 1 μ F ceramic output capacitor
- Dropout at 150mV at 150mA
- Thermal shutdown and current limit protection
- Available in a 2.5mm x 2.5mm 14-pin Thin MLF® package

Applications

- Mobile handsets
- LCD Handset backlighting
- Handset keypad backlighting
- Digital cameras
- Portable media/MP3 players
- Portable navigation devices (GPS)
- Portable applications

DAM, Dynamic Average Matching is a trademark of Micrel, Inc.
MLF and MicroLeadFrame are registered trademark Amkor Technology Inc.

Micrel Inc. • 2180 Fortune Drive • San Jose, CA 95131 • USA • tel +1 (408) 944-0800 • fax + 1 (408) 474-1000 • <http://www.micrel.com>

Typical Application

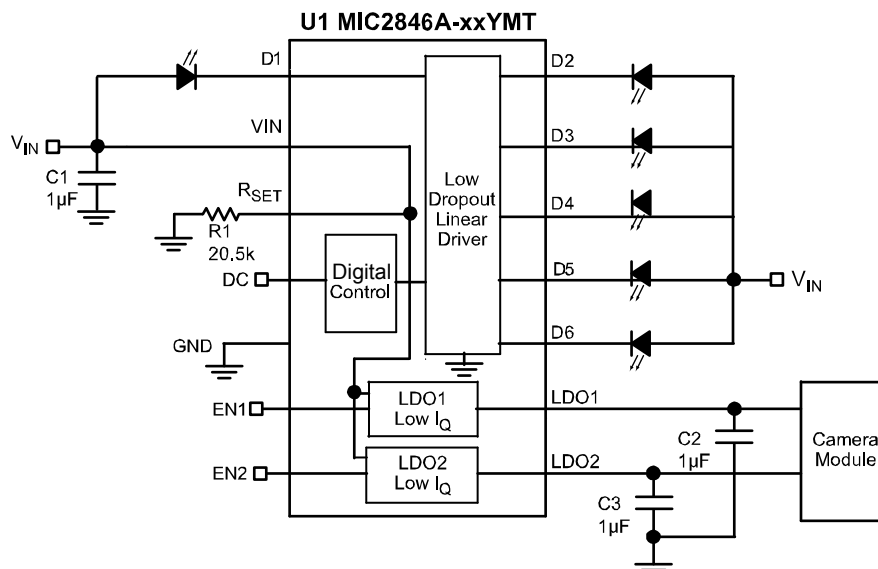

LCD Display Backlight with 6 WLEDs and Camera Module

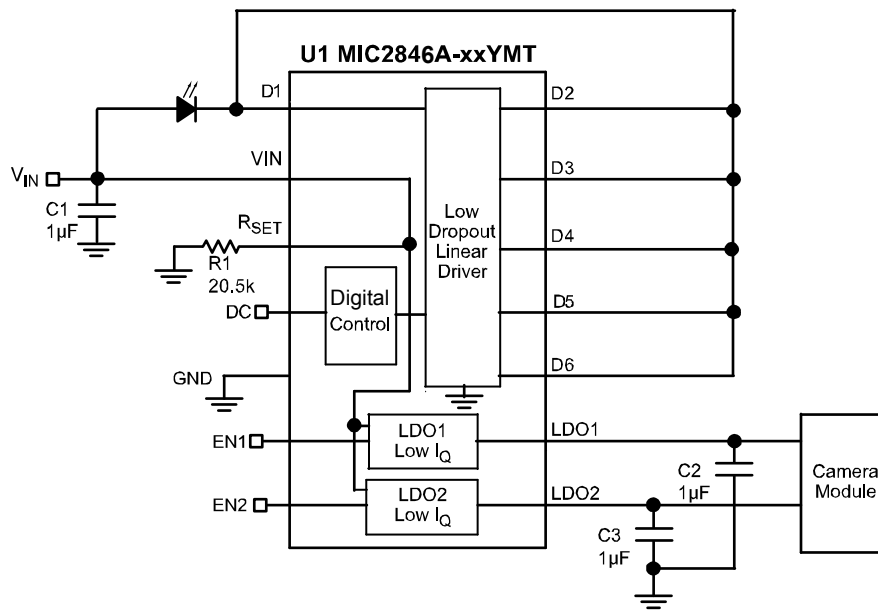

High Current Flash Driver

Ordering Information^(1,2,3)

Part Number	Mark Code	LDO1 VOUT	LDO2 VOUT	Temperature Range	Package
MIC2846A-MFYMT	YPMF	2.8V	1.5V	-40°C to +125°C	14-Pin 2.5mm x 2.5mm TMLF [®]
MIC2846A-MGYMT	YPMG	2.8V	1.8V	-40°C to +125°C	14-Pin 2.5mm x 2.5mm TMLF [®]
MIC2846A-PGYMT	YPPG	3.0V	1.8V	-40°C to +125°C	14-Pin 2.5mm x 2.5mm TMLF [®]
MIC2846A-PPYMT	YPPP	3.0V	3.0V	-40°C to +125°C	14-Pin 2.5mm x 2.5mm TMLF [®]
MIC2846A-SCYMT	YPSC	3.3V	1.0V	-40°C to +125°C	14-Pin 2.5mm x 2.5mm TMLF [®]

Note:

- Thin MLF[®] ▲ = Pin 1 identifier.
- Thin MLF[®] is a GREEN RoHS-compliant package. Lead finish is NiPdAu. Mold compound is halogen free.
- Contact Micrel for other output voltages.

Pin Configuration

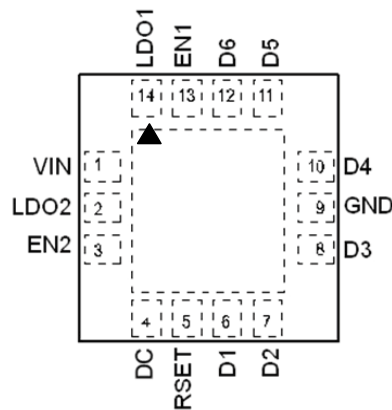

14-Pin 2.5mm x 2.5mm Thin MLF[®] (MT) (Top View)

Pin Description

Pin Number	Pin Name	Pin Function
1	VIN	Voltage Input. Connect at least 1 μ F ceramic capacitor between VIN and GND.
2	LDO2	Output of LDO2. Connect at least 1 μ F ceramic output capacitor.
3	EN2	Enable Input for LDO2. Active High Input. Logic High = On; Logic Low = Off; Do not leave floating.
4	DC	Enable input for LED driver. Can be used for dimming using the digital control interface. See Digital Dimming Interface for details. Do not leave floating.
5	RSET	An internal 1.27V reference sets the nominal maximum LED current. Example, apply a 20.5k Ω resistor between RSET and GND to set LED current to 20mA at 100% duty cycle.
6	D1	LED1 driver. Connect LED anode to VIN and cathode to this pin.
7	D2	LED2 driver. Connect LED anode to VIN and cathode to this pin.
8	D3	LED3 driver. Connect LED anode to VIN and cathode to this pin.
9	GND	Ground.
10	D4	LED4 driver. Connect LED anode to VIN and cathode to this pin.
11	D5	LED5 driver. Connect LED anode to VIN and cathode to this pin.
12	D6	LED6 driver. Connect LED anode to VIN and cathode to this pin.
13	EN1	Enable Input for LDO1. Active High Input. Logic High = On; Logic Low = Off; Do not leave floating.
14	LDO1	Output of LDO1. Connect at least 1 μ F ceramic output capacitor.
EPAD	HS PAD	Heat sink pad. Not internally connected. Connect to ground.

Absolute Maximum Ratings⁽¹⁾

Main Input Voltage (V_{IN})	-0.3V to +6V
Enable Input Voltage (V_{DC} , V_{EN1} , V_{EN2})	-0.3V to +6V
LED Driver Voltage (V_{D1-D6})	-0.3V to +6V
Power Dissipation	Internally Limited ⁽³⁾
Lead Temperature (soldering, 10sec.)	260°C
Storage Temperature (T_s)	-65°C to +150°C
ESD Rating ⁽⁴⁾	ESD Sensitive

Operating Ratings⁽²⁾

Supply Voltage (V_{IN})	+3.0V to +5.5V
Enable Input Voltage (V_{DC} , V_{EN1} , V_{EN2})	0V to V_{IN}
LED Driver Voltage (V_{D1-6})	0V to V_{IN}
Junction Temperature (T_J)	-40°C to +125°C
Junction Thermal Resistance 2.5mm x 2.5mm Thin MLF-14L (θ_{JA})	89°C/W

Electrical Characteristics**Linear WLED Drivers**

$V_{IN} = V_{DC} = 3.8V$, $V_{EN1} = V_{EN2} = 0V$, $R_{SET} = 20.5k\Omega$; $V_{D1-D6} = 0.6V$; $T_J = 25^\circ C$, **bold** values indicate $-40^\circ C \leq T_J \leq 125^\circ C$; unless noted.

Parameter	Conditions	Min	Typ	Max	Units
Current Accuracy ⁽⁵⁾			1.5		%
Matching ⁽⁶⁾			1.5		%
Drop-out	Where $I_{LED} = 90\%$ of LED current seen at $V_{DROPNOM} = 0.6V$, 100% brightness level		40	80	mV
Ground/Supply Bias Current	$I_{LED} = 20mA$		1.4	1.8	mA
Shutdown Current (current source leakage)	$V_{DC} = 0V$ for more than 1260 μs		0.01	1	μA

Digital Dimming

V_{DC} Input Voltage (V_{DC})	Logic Low			0.2	V
	Logic High	1.2			V
V_{DC} Enable Input Current	$V_{DC} = 1.2V$		0.01	1	μA
$t_{SHUTDOWN}$	Time DC pin is low to shutdown the device	1260			μs
t_{MODE_UP}	Time DC pin is low to change to Count Up Mode	100		160	μs
t_{MODE_DOWN}	Time DC pin is low to change to Count Down Mode	420		500	μs
t_{PROG_HIGH} , t_{PROG_LOW}	Time for valid edge count; Ignored if outside limit range	2		32	μs
t_{DELAY}	Time DC pin must remain high before a mode change can occur	100			μs
t_{PROG_SETUP}	First down edge must occur in this window during presetting brightness	5		75	μs
t_{START_UP}	Delay time starting when DC is first pulled high until LEDs start up	140			μs

LDOs

$V_{IN} = V_{EN1} = V_{EN2} = 3.8V$, $V_{DC} = 0V$; $C_{OUT1} = C_{OUT2} = 1\mu F$, $I_{OUT1} = I_{OUT2} = 100\mu A$; $T_J = 25^\circ C$, **bold** values indicate $-40^\circ C \leq T_J \leq 125^\circ C$; unless noted.

Parameter	Conditions	Min	Typ	Max	Units
Output Voltage Accuracy	Variation from nominal V_{OUT}	-2 -3		+2 +3	% %
V_{IN} Line Regulation			0.02	0.3	%/V
Load Regulation	$I_{OUT} = 100\mu A$ to 150mA		7		mV
Dropout Voltage ⁽⁷⁾	$V_{OUT} \geq 3.0V$; $I_{OUT} = 150mA$		150	330	mV
Ground Pin Current			35	70	μA
Ground Pin Current in Shutdown	$V_{EN} = 0V$		0.05	1.0	μA

LDOs (continued)

Parameter	Conditions	Min	Typ	Max	Units
Ripple Rejection	$f = 1\text{kHz}; C_{\text{OUT}} = 2.2\mu\text{F}$		65		dB
Current Limit	$V_{\text{OUT}} = 0\text{V}$	175	300	500	mA
Output Voltage Noise	Frequency 10Hz to 100kHz		200		μV_{RMS}

Enable Inputs (EN1,2)

Enable Input Voltage	Logic Low			0.2	V
	Logic High	1.2			V
Enable Input Current	$V_{\text{EN1}} = V_{\text{EN2}} = 1.2\text{V}$		0.01	1	μA
Turn-on Time	$C_{\text{OUT}} = 1\mu\text{F}; 90\% \text{ of } V_{\text{OUT}}$		50	100	μs

Notes:

- Exceeding the absolute maximum rating may damage the device.
- The device is not guaranteed to function outside its operating rating.
- The maximum allowable power dissipation of any T_A (ambient temperature) is $P_{\text{D(max)}} = (T_{\text{J(max)}} - T_A) / \theta_{\text{JA}}$. Exceeding the maximum allowable power dissipation will result in excessive die temperature, and the regulator will go into thermal shutdown (150°C).
- Devices are ESD sensitive. Handling precautions recommended. Human Body Model (HBM), $1.5\text{k}\Omega$ in series with 100pF .
- As determined by average current of all channels in use and all channels loaded.
- The current through each channel meets the stated limits from the average current of all channels.
- Dropout voltage is defined as the input-output differential at which the output voltage drops 2% below its nominal value measured at $V_{\text{IN}} = V_{\text{OUT}} + 1\text{V}$.

Typical Characteristics (WLED Driver)

Average LED Current vs. Brightness Level (30mA Peak)

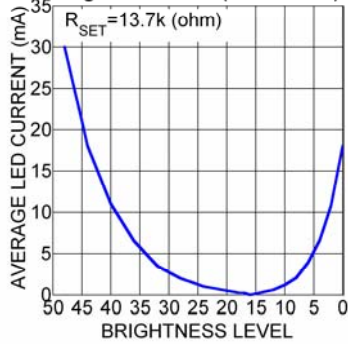

Average LED Current vs. Brightness Level (20mA Peak)

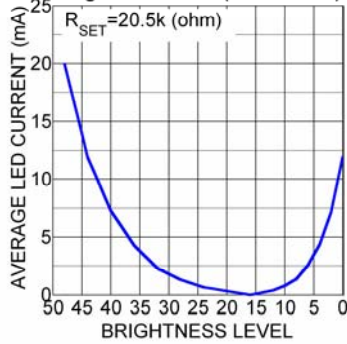

Average LED Current vs. Brightness Level (5mA Peak)

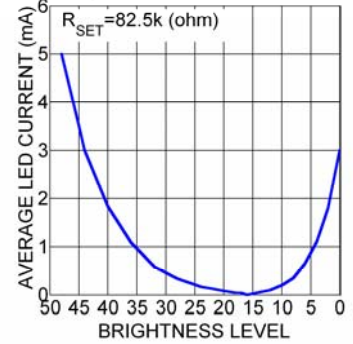

Single Channel Current vs. R_{SET}

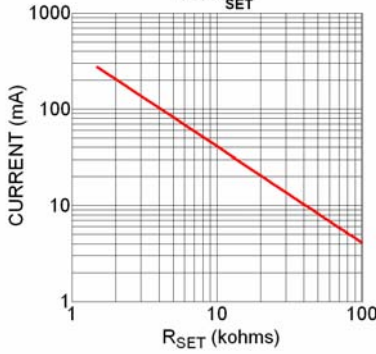

Six Parallel Channels Current vs. R_{SET}

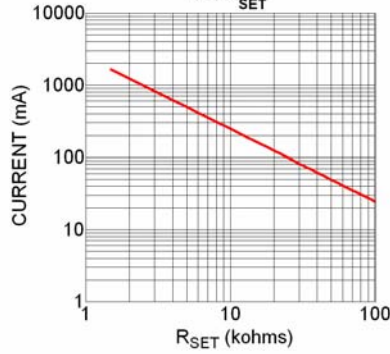

LED Driver Dropout vs. Temperature

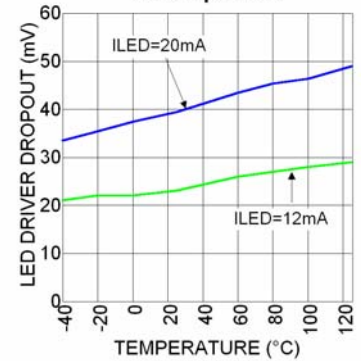

Single Channel Dropout vs. Load Current

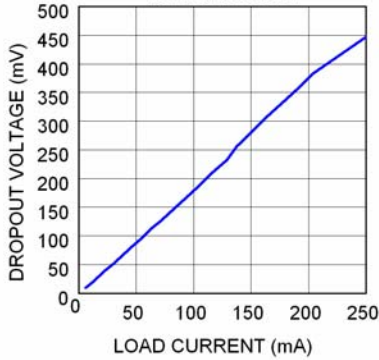

6 Parallel Channels Dropout vs. Load Current

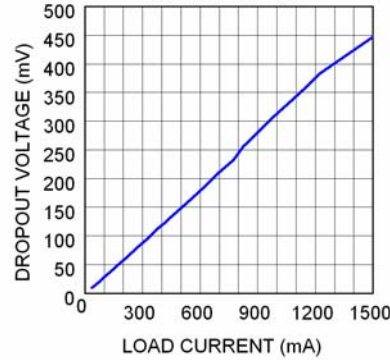

12mA Peak ILED vs. Battery Voltage

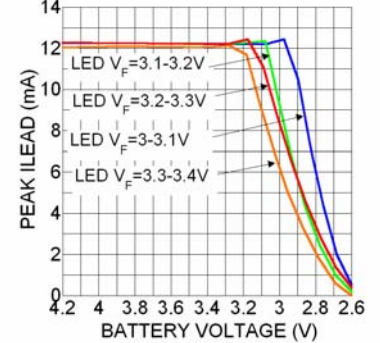

20mA Peak ILED vs. Battery Voltage

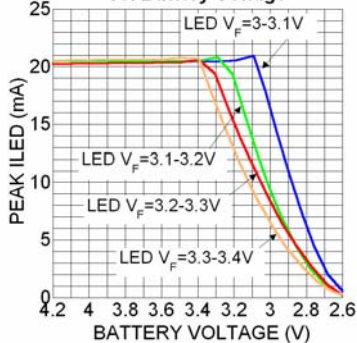

LED Current Matching vs. Temperature

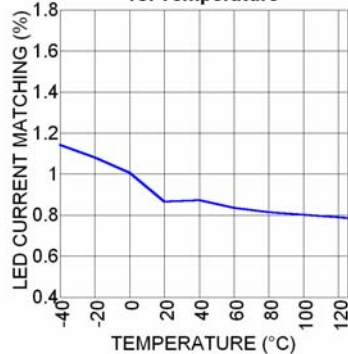

LED Current vs. Temperature

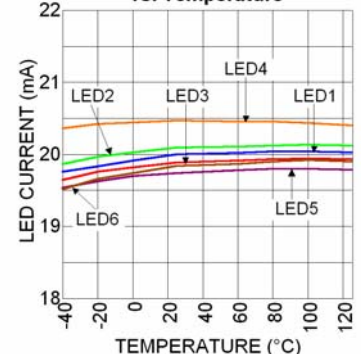

Typical Characteristics (LDO)

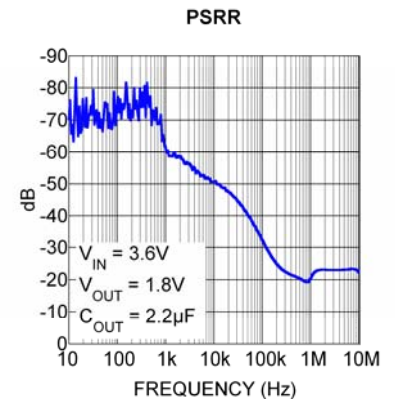
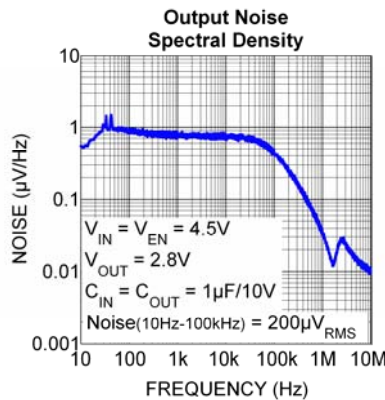
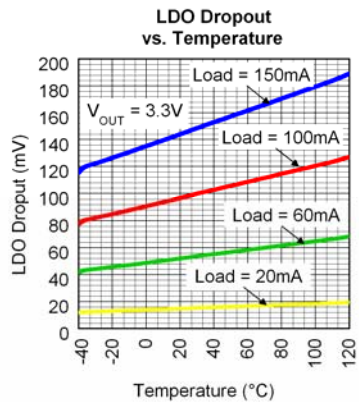
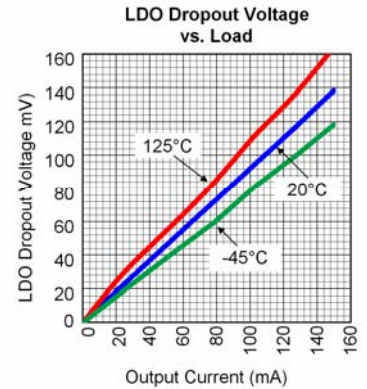
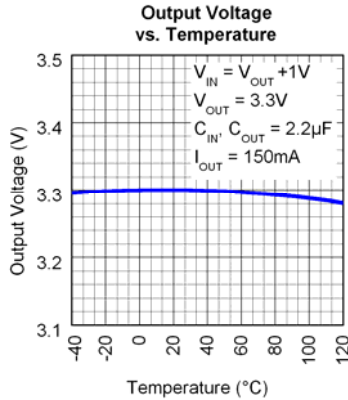
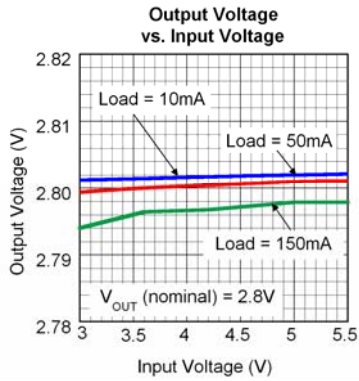
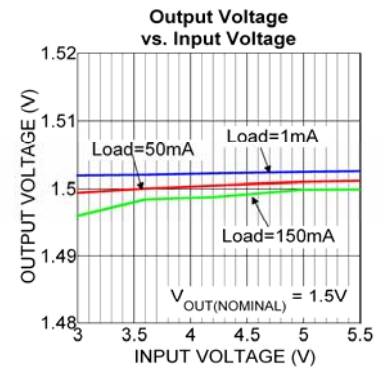
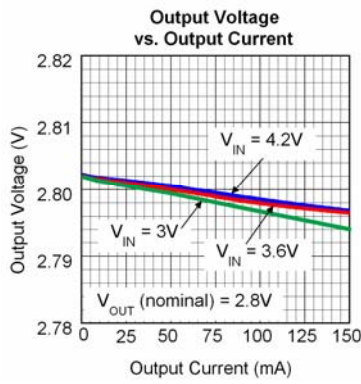
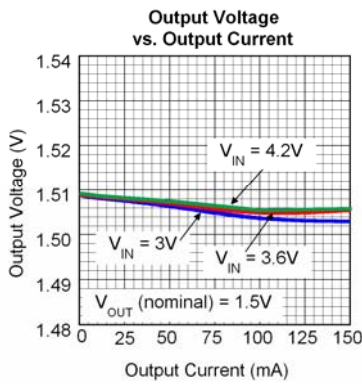
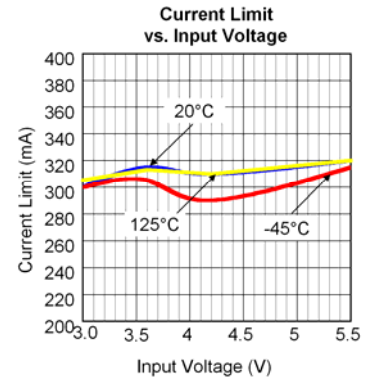
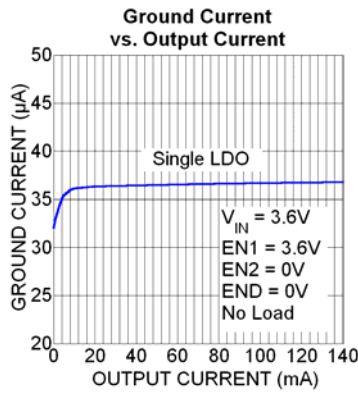
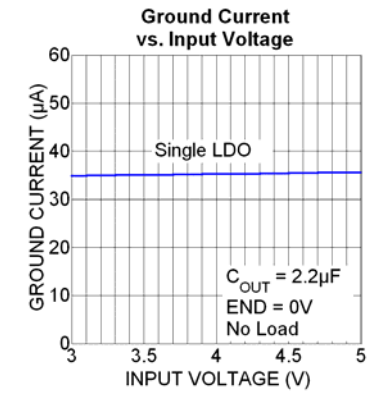

Functional Characteristics (WLED Driver)

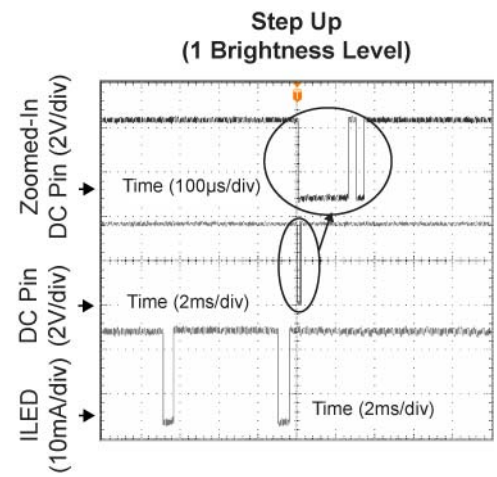
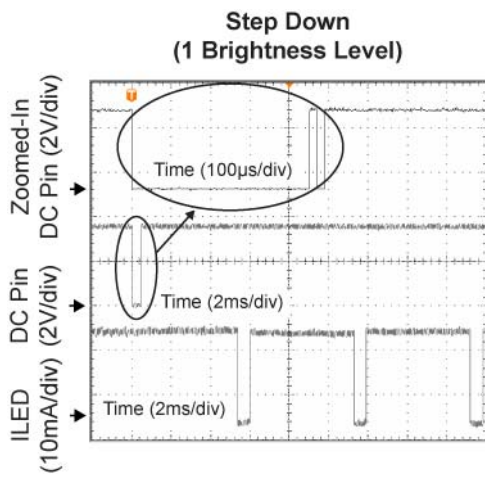
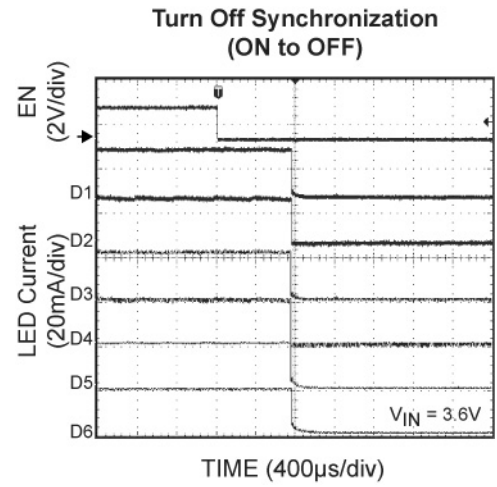
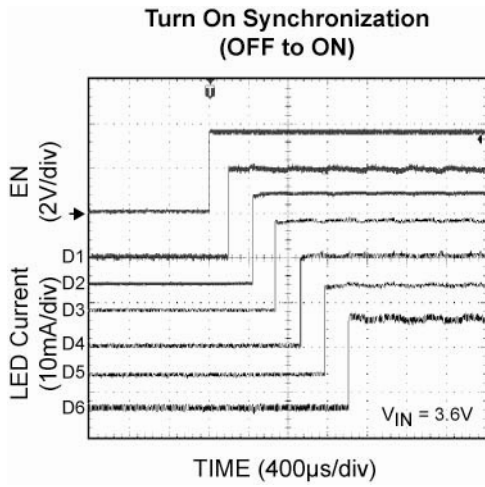

Functional Characteristics (LDO)

LDO Start-Up with No Load

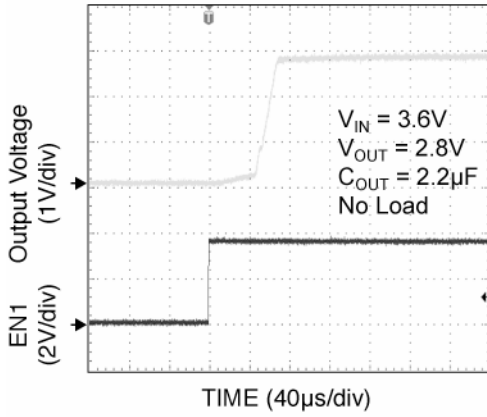

LDO Start-Up with 150mA Load

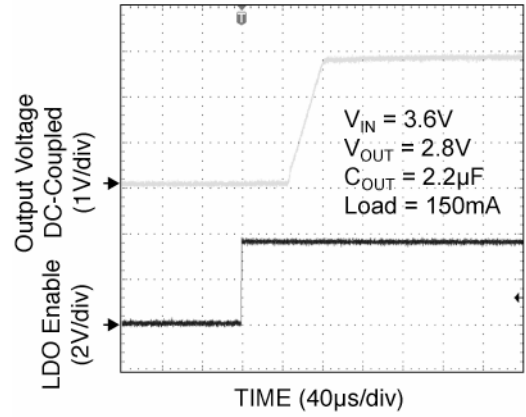

Dual LDO Start-Up with 150mA Load Each

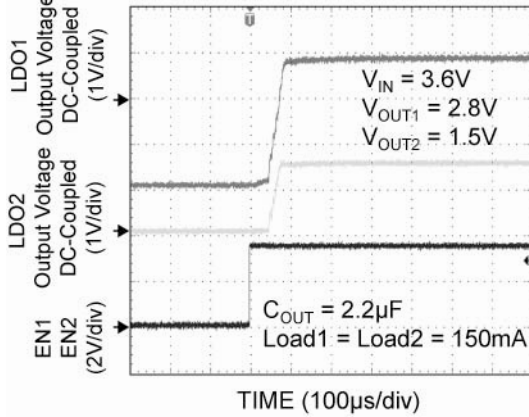

Load Transient from 10mA to 150mA on LDO1

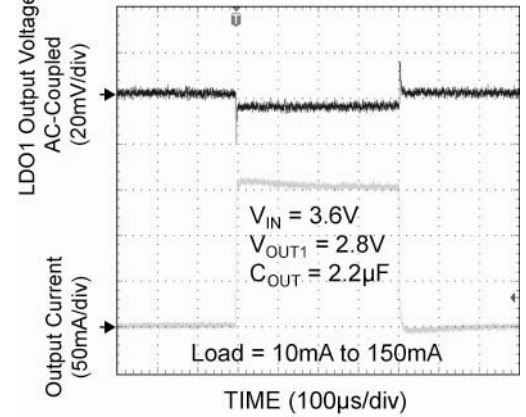

Load Transient from 10mA to 150mA on LDO1

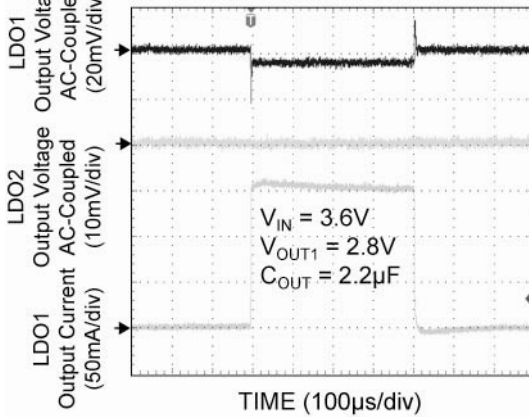

LDO Short Circuit Recovery to 150mA Load

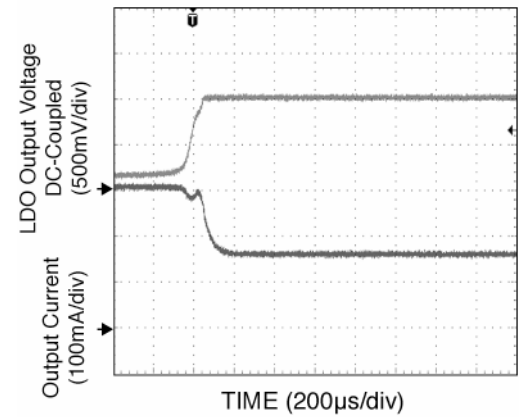

Functional Diagram

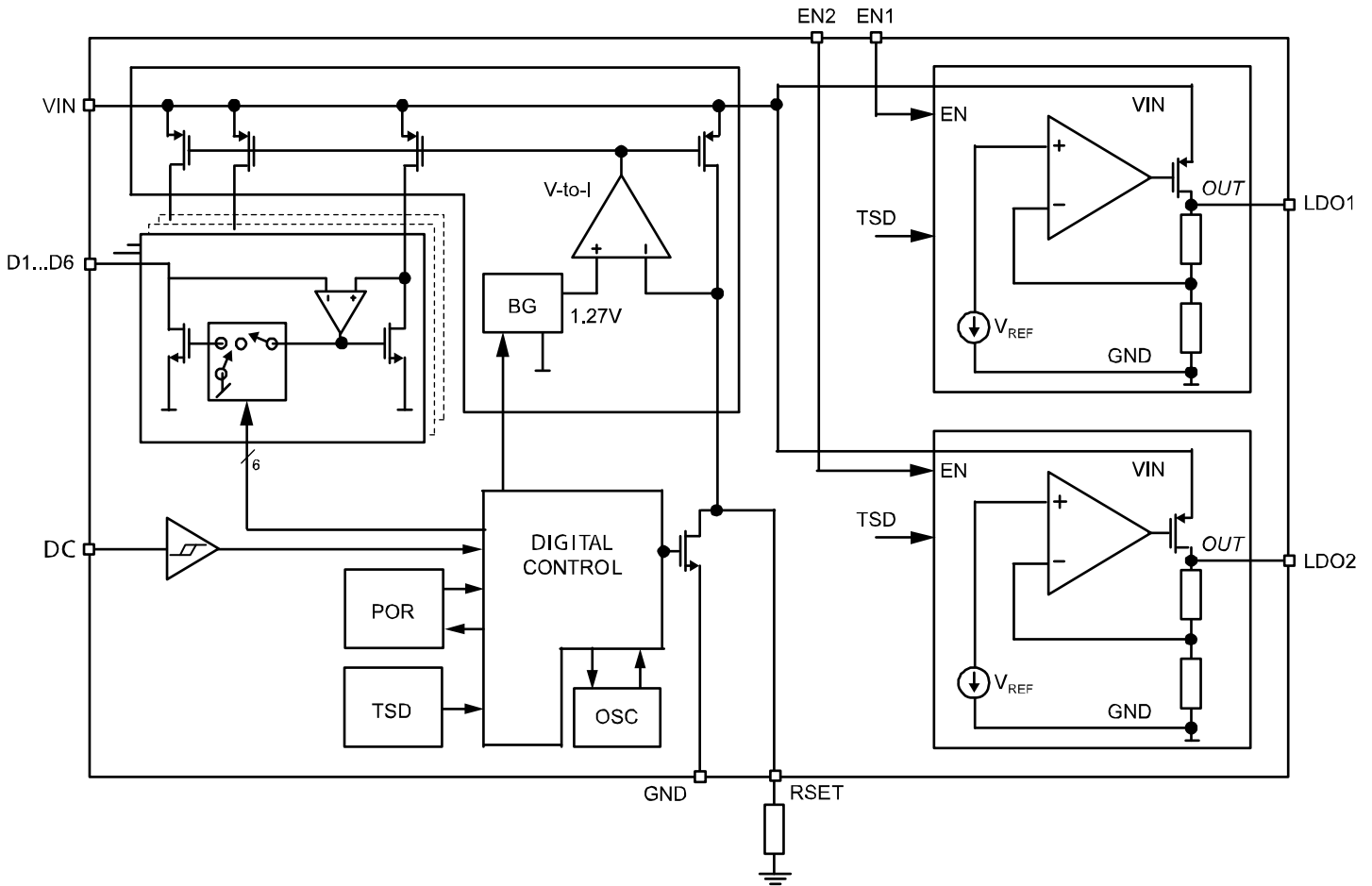

Figure 1. MIC2846A Functional Block Diagram

Functional Description

The MIC2846A is a six channel linear LED driver with dual 150mA LDOs. The LED driver incorporates a Dynamic Averaged Matching™ (DAM™) technique designed specifically to optimize on current accuracy and matching across process variation. It can maintain proper current regulation with LED current accuracy of 1.5% while the typical matching between the six channels is 1.5% at room temperature. The LED currents are independently driven from the input supply and will maintain regulation with a dropout of 40mV at 20mA. The low dropout of the linear LED Drivers allows the LEDs to be driven directly from the battery voltage and eliminates the need for boost or large and inefficient charge pumps. The maximum LED current for each channel is set via an external resistor while a single-wire digital interface controls dimming.

The MIC2846A has two LDOs with a dropout voltage of 150mV at 150mA and consume 35µA of current in operation. Each LDO has an independent enable pin, which reduces the operating current to less than 1µA in shutdown. Both linear regulators are stable with just 1µF of output capacitance.

Block Diagram

As shown in Figure 1, the MIC2846A consists of two LDOs with six current mirrors set to copy a master current determined by R_{SET} . The linear LED drivers have a designated control block for enabling and dimming of the LEDs. The MIC2846A dimming is controlled by the Digital Control block that receives digital signals for dimming. The LDOs each have their own control and are independent of the linear LED drivers. Each LDO consists of internal feedback resistors, an error amplifier, a PFET transistor and a control circuit for enabling.

VIN

The input supply (VIN) provides power to the LDOs, the linear LED drivers and the control circuitry. The VIN operating range is 3V to 5.5V. A minimum bypass capacitor of 1 μ F should be placed close to the input (VIN) pin and the ground (GND) pin. Refer to the layout recommendations section for details on placing the input capacitor (C1).

LDO1/LDO2

The output pins for LDO one and LDO two are labeled LDO1 and LDO2, respectively. A minimum of 1 μ F bypass capacitor should be placed as close as possible to the output pin of each LDO. Refer to the layout recommendations section for details on placing the output capacitor (C2, C3) of the LDOs.

EN1/EN2

A logic high signal on the enable pin activates the LDO output voltage of the device. A logic low signal on the enable pin deactivates the output and reduces supply current to less than 1 μ A. EN1 controls LDO1 and EN2 controls LDO2. Do not leave these control pins floating.

DC

The DC pin is used to enable and control dimming of the linear drivers on the MIC2846A. See the MIC2846A Digital Dimming Interface in the Application Information section for details. Pulling the DC pin low for more than 1260 μ s puts the MIC2846A into a low IQ sleep mode. The DC pin cannot be left floating; a floating enable pin may cause an indeterminate state on the outputs. A 200k Ω pull down resistor is recommended.

RSET

The RSET pin is used by connecting a RSET resistor to ground to set the peak current of the linear LED driver. The average LED current can be calculated by the equation (1).

$$I_{LED} \text{ (mA)} = 410 * \text{ADC} / R_{SET} \text{ (k}\Omega) \quad (1)$$

ADC is the average duty cycle of the LED current controlled by the single-wire digital dimming. See Table 1 for ADC values. When the device is fully on the average duty cycle equals 100% (ADC=1). A plot of ILED versus RSET at 100% duty cycle is shown in Figure 2.

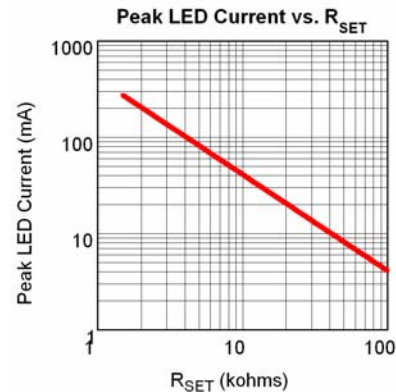

Figure 2. Peak LED Current vs. RSET (100% Duty Cycle)

D1-D6

The D1 through D6 pins are the LED driver for LED 1 through 6, respectively. The anodes of the LEDs are connected to VIN and the cathodes of the LEDs are connected to D1 through D6. When operating with less than six LEDs, leave the unused D pins unconnected. The six LED channels are independent of one another and may be combined or used separately. During start-up, the D1 through D6 channels are turned on in synchronization at around 250 μ s apart.

GND

The ground pin is the ground path for the linear drivers and LDOs. The ground of the input capacitor should be routed with low impedance traces to the GND pin and made as short as possible. Refer to the layout recommendations for more details.

Application Information

Brightness Level (0 - 48)	Average Duty Cycle (%)	Average I _{LED} (mA)	I _{PEAK} (mA)
0	100	12	60% of I_{PEAK} R_{SET} = 20.5kΩ I_{PEAK} = 12mA
1	80	9.6	
2	60	7.2	
3	48.33	5.8	
4	36.67	4.4	
5	29.17	3.5	
6	21.67	2.6	
7	16.67	2	
8	11.67	1.4	
9	9.17	1.1	
10	6.67	0.8	
11	5	0.6	
12	3.33	0.4	
13	2.5	0.3	
14	1.67	0.2	
15	0.83	0.1	
16	0	0	0
17	0.83	0.1	60% of I_{PEAK}
18	0.83	0.17	100% of I_{PEAK} R_{SET} = 20.5kΩ I_{PEAK} = 20mA
19	1.25	0.25	
20	1.67	0.33	
21	2.08	0.42	
22	2.5	0.5	
23	2.92	0.58	
24	3.33	0.67	
25	4.17	0.83	
26	5	1	
27	5.83	1.17	
28	6.67	1.33	
29	7.92	1.58	
30	9.17	1.83	
31	10.42	2.08	
32	11.67	2.33	
33	14.17	2.83	
34	16.67	3.33	
35	19.17	3.83	
36	21.67	4.33	
37	25.42	5.08	
38	29.17	5.83	
39	32.92	6.58	
40	36.67	7.33	
41	42.5	8.5	
42	48.33	9.67	
43	54.17	10.83	
44	60	12	
45	70	14	
46	80	16	
47	90	18	
48	100	20	

Table 1. Digital Interface Brightness Level Table

Dynamic Average Matching (DAM™)

The Dynamic Average Matching™ architecture multiplexes four voltage references to provide highly accurate LED current and channel matching. The MIC2846A achieves industry leading LED channel matching of 1.5% across the entire dimming range.

High Current Parallel Operation

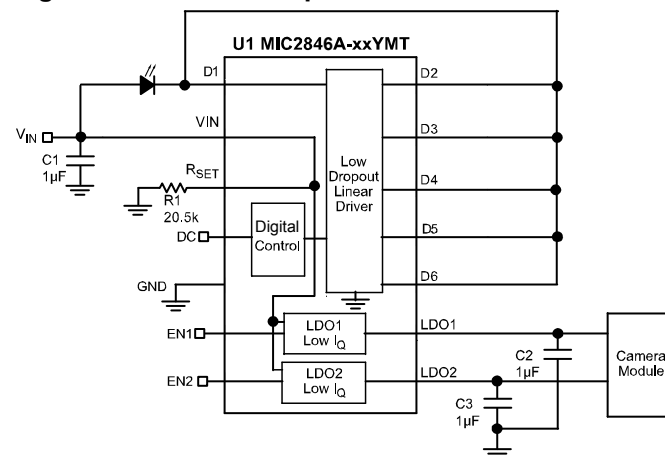

Figure 3. High Current LED Driver Circuit

The linear drivers are independent of each other and can be used individually or paralleled in any combination for higher current applications. A single WLED can be driven with all 6 linear drivers by connecting D1 through D6 in parallel to the cathode of the WLED as shown in Figure 3. This will generate a current 6 times the individual channel current and can be used for higher current WLEDs such as those used in flash or torch applications.

Digital Dimming

The MIC2846A utilizes an internal dynamic pulse width to generate an average duty cycle for each brightness level. By varying the duty cycle the average current achieves 49 logarithmically spaced brightness levels. This generates a brightness scale similar to the perception of brightness seen by the “human eye.” Figure 4 shows the LED current at different brightness levels. When dimming, the D1 through D6 pins are 60° out of phase from each other to reduce electromagnetic interference. The MIC2846A uses an internal frequency of approximately 700Hz to dim the WLEDs. With the period of approximately 1.43ms, the 60° phase shift equates to a timing offset of 238μs. As shown in Figure 5, brightness level 32 was selected to show the phase shift across the channels.

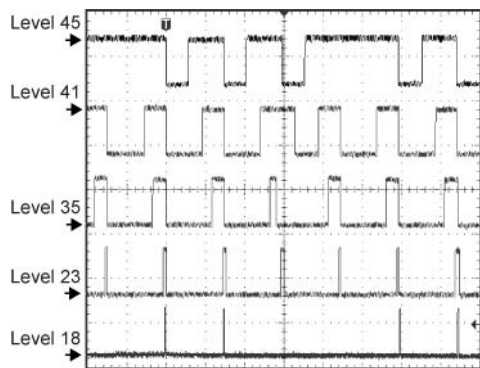

Figure 4. LED Current with Brightness Level Change

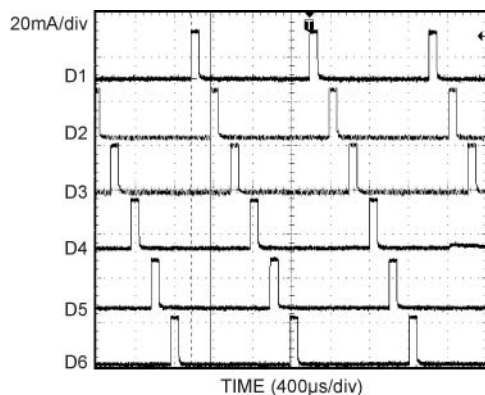

Figure 5. LED Current 60° Phase Shift

Digital Dimming Interface

The MIC2846A incorporates an easy to use single-wire, serial programming interface that allows users to set LED brightness up to 49 different levels, as shown in the table1.

Brightness levels 0 through 15 are logarithmically spaced with a peak current equal to 60% of the current programmed by R_{SET} . Brightness level 16 is provided for applications that want to “fade to black” with no current flowing through the LEDs. Brightness Level 17 has the same duty cycle as level 18, but the peak current is only 60% of the current set by R_{SET} ; therefore, the average current is 0.1mA. Brightness levels 18 through 48 are also logarithmically spaced, but the peak current is equal to 100% of the current determined by R_{SET} . Refer to Table 1 for the translation from brightness level to average LED duty cycle and current. The MIC2846A is designed to receive programming pulses to increase or decrease brightness. Once the brightness change signal is received, the DC pin is simply pulled high to maintain the brightness. This “set and forget” feature relieves processor computing power by eliminating the need to constantly send a PWM signal to the dimming pin. With a digital control interface, brightness levels can also be preset so that LEDs can be turned on at any particular

brightness level.

Start Up

Assuming the MIC2846A has been off for a long time and no presetting brightness command is issued (presetting is discussed in a later section), the MIC2846A will start-up in its default mode approximately 140µs (t_{START_UP}) after a logic level high is applied to the DC pin, shown in Figure 6. In the default mode the LEDs are turned on at the maximum brightness level of 48. Each falling edge during the t_{PROG_SETUP} period will cause the default brightness level to decrease by one. This is discussed in more detail in the Presetting Brightness section.

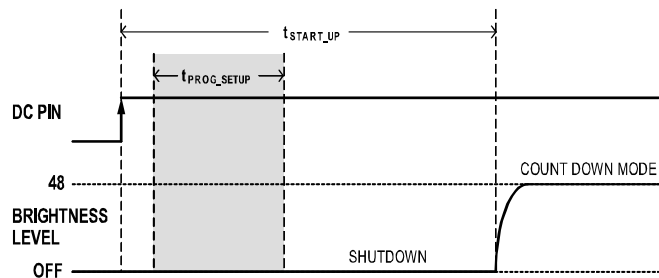

Figure 6. Typical Start-Up Timing

Shutdown

Whenever the DC input pin is pulled low for a period greater than or equal to $t_{SHUTDOWN}$ (1260µs), the MIC2846A will be shutdown as shown in Figure 7.

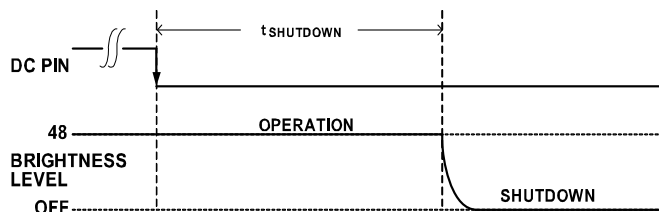

Figure 7. Shutdown Timing

Once the device is shutdown, the control circuit supply is disabled and the LEDs are turned off, drawing only 0.01µA. Brightness level information stored in the MIC2846A prior to shutdown will be erased.

Count Up Mode/Count Down Mode

The mode of MIC2846A can be in either Count Up Mode or Count Down Mode. The Count Down/Up Modes determine what the falling edges of the programming pulses will do to the brightness. In Count Up Mode, subsequent falling edges will increase brightness while in Count Down Mode, subsequent falling edges will decrease brightness. By default, the MIC2846A is in Count Down Mode when first turned on. The counting mode can be changed to Count Up Mode, by pulling the DC pin low for a period equal to t_{MODE_UP} (100µs to 160µs), shown in Figure 8. The device will remain in

Count Up Mode until its mode is changed to Count Down Mode or by disabling the MIC2846A to reset the mode back to default.

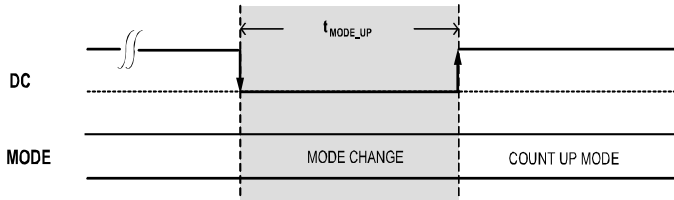

Figure 8. Mode Change to Count Up

To change the mode back to Count Down Mode, pull the DC pin low for a period equal to t_{MODE_DOWN} (420 μ s to 500 μ s), shown in Figure 9. Now the internal circuitry will remain in Count Down Mode until changed to Count Up as described previously.

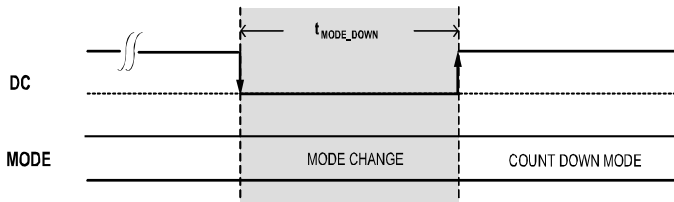

Figure 9. Mode Change to Count Down

Programming the Brightness Level

MIC2846A is designed to start driving the LEDs 140 μ s (t_{START_UP}) after the DC pin is first pulled high at the maximum brightness level of 48. After start up, the internal control logic is ready to decrease the LED brightness upon receiving programming pulses (negative edges applied to DC pin). Since MIC2846A starts in Count Down Mode, the brightness level can be decreased without a mode change by applying two programming pulses, as shown in Figure 10. Note that the extra pulse is needed to decrease brightness because the first edge is ignored. Anytime the first falling edge occurs later than 32 μ s after a Mode Change, it will be ignored. Ignoring the first falling edge is necessary in order that Mode Change (t_{MODE_UP} , t_{MODE_DOWN}) pulses do not result in adjustments to the brightness level. Each programming pulse has a high (t_{PROG_HIGH}) and a low (t_{PROG_LOW}) pulse width that must be between 2 μ s to 32 μ s. The MIC2846A will remember the brightness level and mode it was changed to. For proper operation, ensure that the DC pin remains high for at least t_{DELAY} (140 μ s) before issuing a mode change command.

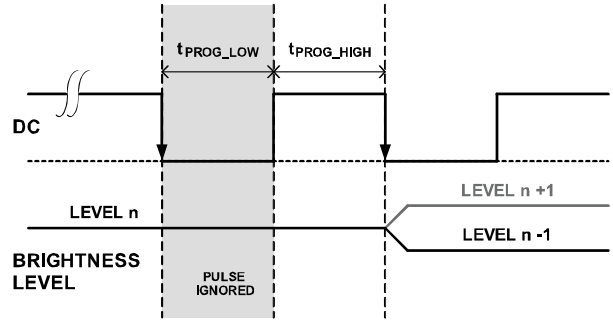

Figure 10. Brightness Programming Pulses

Multiple brightness levels can be set as shown in Figure 11. When issuing multiple brightness level adjustments to the DC pin, ensure both t_{PROG_LOW} and t_{PROG_HIGH} are within 2 μ s to 32 μ s.

To maintain operation at the current brightness level simply maintain a logic level high at the DC pin.

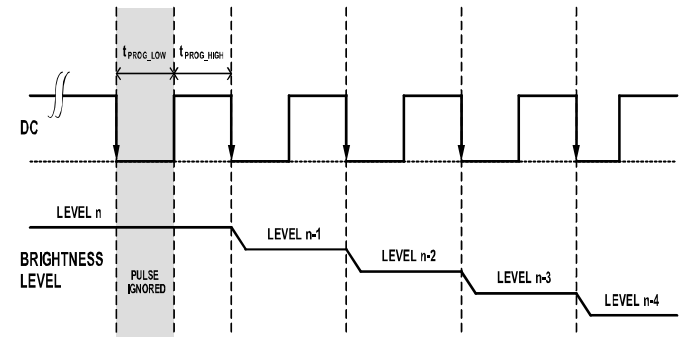

Figure 11. Decreasing Brightness Several Levels

As mentioned, MIC2846A can be programmed to set LED drive current to produce one of 49 distinct brightness levels. The internal logic keeps track of the brightness level with an Up/Down counter circuit. The following section explains how the brightness counter functions with continued programming edges.

Counter Roll-Over

The MIC2846A internal up/down counter contains registers from 0 to 48 (49 levels). When the brightness level is at 0 and a programming pulse forces the brightness to step down, then the counter will roll-over to level 48. This is illustrated in Figure 12.

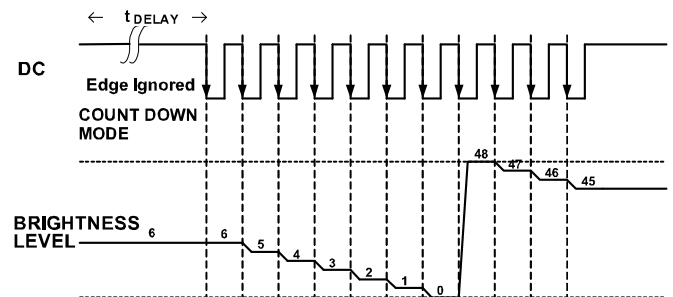

Figure 12. Down Counter Roll-Over

Similarly, when the counter mode is set to Count Up and a programming pulse forces the brightness level to step up from level 48, then the counter will roll-over to level 0 as illustrated in Figure 13.

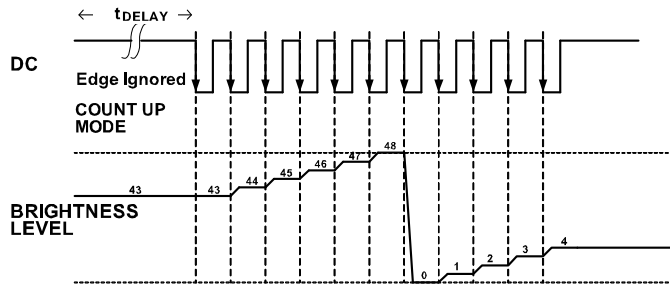

Figure 13. Up Counter Roll-Over

One-Step Brightness Changes

The “One-Step” brightness change procedure relieves the user from keeping track of the MIC2846A’s up/down counter mode. It combines a Mode Change with a programming edge; therefore, regardless of the previous Count Mode, it will change the brightness level by one.

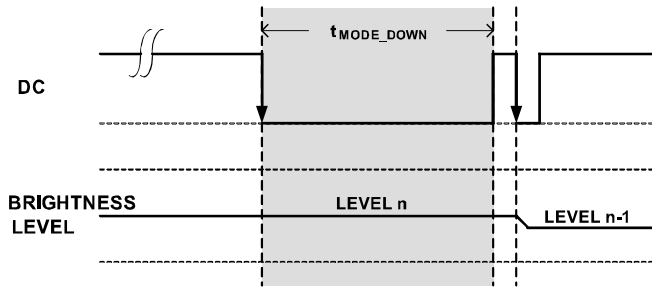

Figure 14. One-Step Brightness Decrease

The One-Step Brightness Decrease method is quite simple. First, the DC pin is pulled low for a period equal to the t_{MODE_DOWN} (420 μ s to 500 μ s) and immediately followed by a falling edge within t_{PROG_HIGH} (2 μ s to 32 μ s) as shown in Figure 14. This will decrease the brightness level by 1. Similarly a One-Step Brightness Increase can be assured by first generating a DC down pulse whose period is equal to the t_{MODE_UP} (100 μ s to 160 μ s) and immediately followed by a falling edge within t_{PROG_HIGH} (2 μ s to 32 μ s). Figure 15 illustrates the proper timing for execution of a One-Step Brightness Increase.

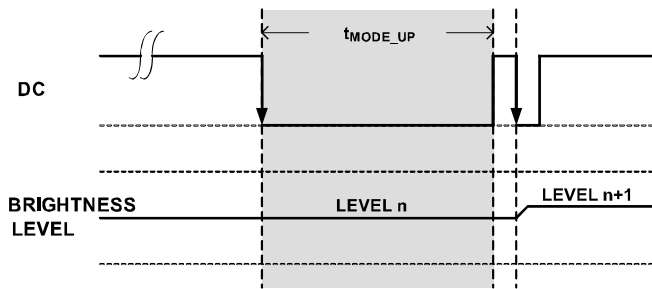

Figure 15. One-Step Brightness Increase

Presetting Brightness

Presetting the brightness will allow the MIC2846A to start-up at any brightness level (0 to 48). The MIC2846A does not turn on the linear LED driver until the DC pin is kept high for t_{START_UP} (140 μ s). This grants the user time to preset the brightness level by sending a series of programming edges via the DC pin. The precise timing for the first down edge is between 5 μ s and 75 μ s after the DC pin is first pulled high. The 70 μ s timeframe between 5 μ s and 75 μ s is the t_{PROG_SETUP} period. The first presetting pulse edge must occur somewhere between the timeframe of 5 μ s to 75 μ s, otherwise the MIC2846A may continue to start up at the full (default) brightness level.

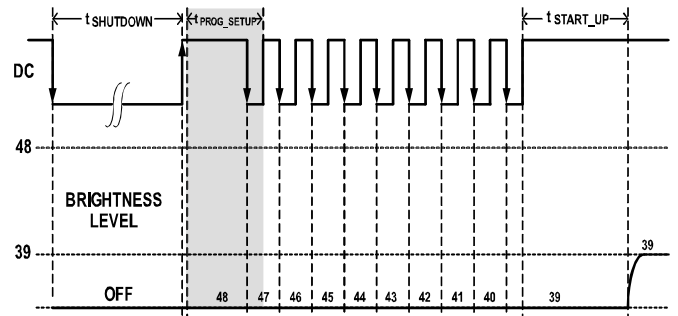

Figure 16. Presetting Timing

Figure 16 shows the correct presetting sequence to set the MIC2846A brightness to level 39 prior to start up. Notice that when using the presetting feature the first programming pulse is not ignored. This is because the counter’s default mode is Count Down and a Mode Change cannot be performed in the presetting mode. (Note that the t_{PROG_HIGH} and t_{PROG_LOW} pulse width must still be between 2 μ s to 32 μ s.)

LDO

MIC2846A LDOs are low noise 150mA LDOs. The MIC2846A LDO regulator is fully protected from damage due to fault conditions, offering linear current limiting and thermal shutdown.

Input Capacitor

The MIC2846A stability can be maintained using a ceramic input capacitor of 1 μ F. Low-ESR ceramic capacitors provide optimal performance at a minimum amount of space. Additional high-frequency capacitors, such as small-valued NPO dielectric-type capacitors, help filter out high-frequency noise and are good practice in any noise sensitive circuit. X5R or X7R dielectrics are recommended for the input capacitor. Y5V dielectrics lose most of their capacitance over temperature and are therefore, not recommended.

Output Capacitor

The MIC2846A LDOs require an output capacitor of at least 1 μ F or greater to maintain stability, however, the output capacitor can be increased to 2.2 μ F to reduce output noise without increasing package size. The design is optimized for use with low-ESR ceramic chip capacitors. High ESR capacitors are not recommended because they may cause high frequency oscillation. X7R/X5R dielectric-type ceramic capacitors are recommended due to their improved temperature performance compared to Z5U and Y5V capacitors. X7R-type capacitors change capacitance by 15% over their operating temperature range and are the most stable type of ceramic capacitors. Z5U and Y5V dielectric capacitors change value by as much as 50% and 60%, respectively, over their operating temperature ranges. To use a ceramic chip capacitor with Y5V dielectric, the value must be much higher than an X7R ceramic capacitor to ensure the same minimum capacitance over the equivalent operating temperature range.

No-Load Stability

Unlike many other voltage regulators, the MIC2846A LDOs will remain stable and in regulation with no load.

Thermal Considerations

The MIC2846A LDOs are each designed to provide 150mA of continuous current. Maximum ambient operating temperature can be calculated based on the

output current and the voltage drop across the part. For example if the input voltage is 3.6V, the output voltage is 2.8V, and the output current = 150mA. The actual power dissipation of the regulator circuit can be determined using the equation:

$$P_{LDO1} = (V_{IN} - V_{OUT1}) I_{OUT} + V_{IN} I_{GND}$$

Because this device is CMOS and the ground current (I_{GND}) is typically <100 μ A over the load range, the power dissipation contributed by the ground current is < 1% and can be ignored for this calculation.

$$P_{LDO1} = (3.6V - 2.8V) \times 150mA$$

$$P_{LDO1} = 0.120W$$

Since there are two LDOs in the same package, the power dissipation must be calculated individually and then summed together to arrive at the total power dissipation.

$$P_{TOTAL} = P_{LDO1} + P_{LDO2}$$

To determine the maximum ambient operating temperature of the package, use the junction-to-ambient thermal resistance ($\theta_{JA} = 60^{\circ}C/W$) of the device and the following basic equation:

$$P_{TOTAL(max)} = \left(\frac{T_{J(max)} - T_A}{\theta_{JA}} \right)$$

$T_{J(max)} = 125^{\circ}C$, is the maximum junction temperature of the die and θ_{JA} , is the thermal resistance = $60^{\circ}C/W$.

Substituting P_{TOTAL} for $P_{TOTAL(max)}$ and solving for the ambient operating temperature will give the maximum operating conditions for the regulator circuit.

For example, when operating the MIC2846A LDOs (LDO1=2.8V and LDO2=1.5V) at an input voltage of 3.6V with 150mA load on each, the maximum ambient operating temperature T_A can be determined as follows:

$$P_{LDO1} = (3.6V - 2.8V) \times 150mA = 0.120W$$

$$P_{LDO2} = (3.6V - 1.5V) \times 150mA = 0.315W$$

$$P_{TOTAL} = 0.120W + 0.315W = 0.435W$$

$$= (125^{\circ}C - T_A) / (60^{\circ}C/W)$$

$$T_A = 125^{\circ}C - 0.435W \times 60^{\circ}C/W$$

$$T_A = 98.9^{\circ}C$$

Therefore, under the above conditions, the maximum ambient operating temperature of $98.9^{\circ}C$ is allowed.

MIC2846A Typical Application Circuit

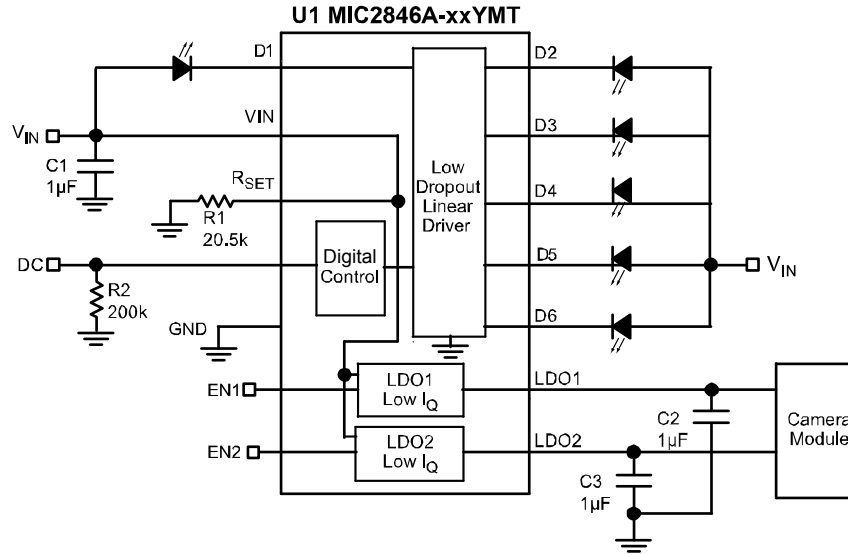

Bill of Materials

Item	Part Number	Manufacturer	Description	Qty.
C1, C2, C3	C1608X5R0J105K	TDK ⁽¹⁾	Ceramic Capacitor, 1µF, 6.3V, X5R, Size 0603	1
	06036D105KAT2A	AVX ⁽²⁾		
	GRM188R60J105KE19D	Murata ⁽³⁾		
	VJ0603G225KXYAT	Vishay ⁽⁴⁾		
D1 – D6	SWTS1007	Seoul Semiconductor ⁽⁵⁾	WLED	6
	99-116UNC	EverLight ⁽⁶⁾		
R1	CRCW060320K5F5EA	Vishay ⁽⁴⁾	Resistor, 20.5k, 1%, 1/16W, Size 0603	1
R2	CRCW06032003FK5EA	Vishay ⁽⁴⁾	Resistor, 200k, 1%, 1/16W, Size 0603	1
U1	MIC2846A-xxYMT	Micrel, Inc. ⁽⁷⁾	6 Channel Digital Control Linear WLED Driver with DAM™ and Dual Low IQ LDO	1

Notes:

1. TDK: www.tdk.com
2. AVX: www.avx.com
3. Murata: www.murata.com
4. Vishay: www.vishay.com
5. Seoul Semiconductor: www.seoulsemicon.com
6. EverLight: www.everlight.com
7. Micrel, Inc.: www.micrel.com

PCB Layout Recommendations (Fixed)

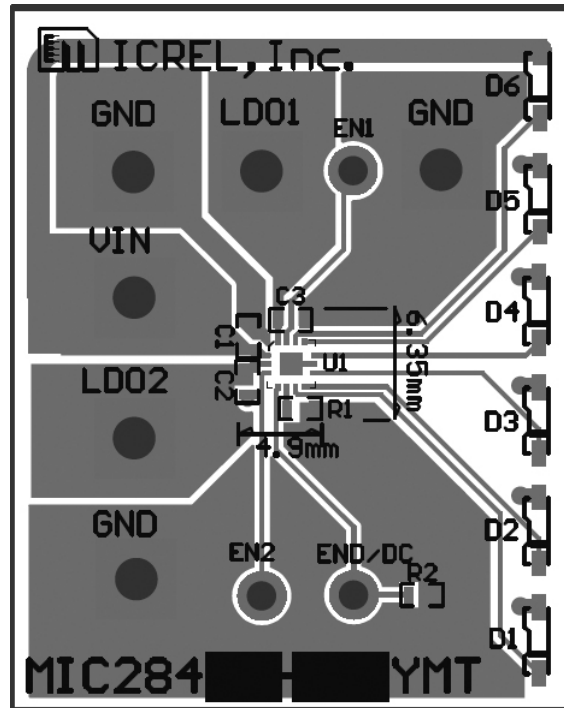

Top Layer

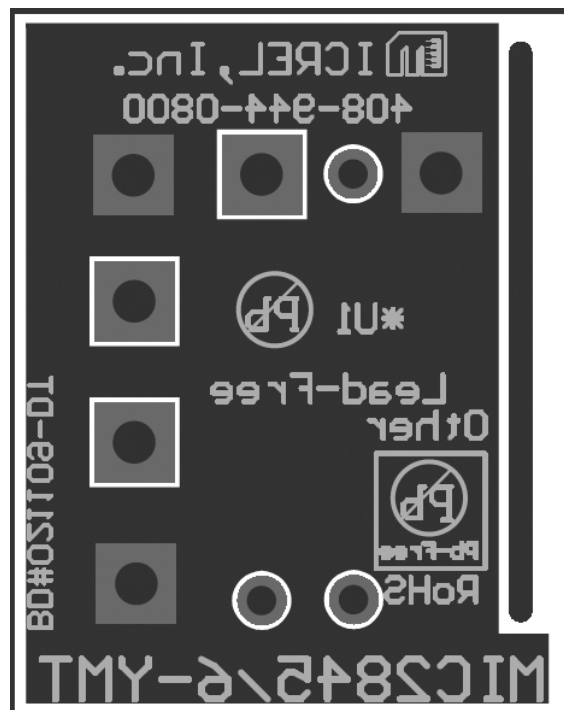

Bottom Layer

Package Information

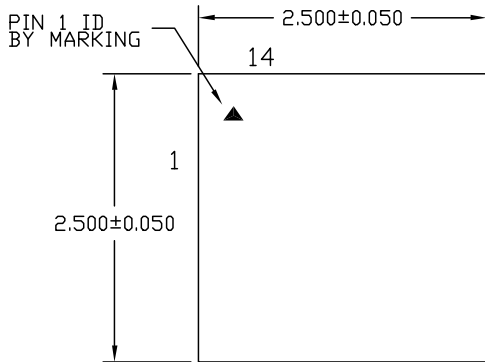

TOP VIEW

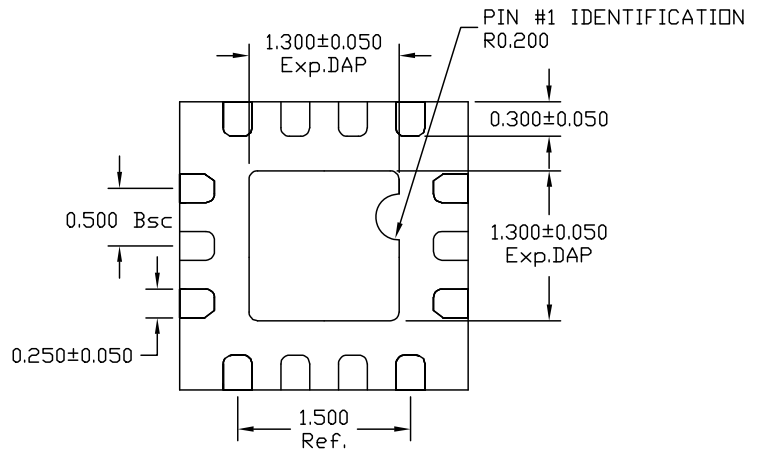

BOTTOM VIEW

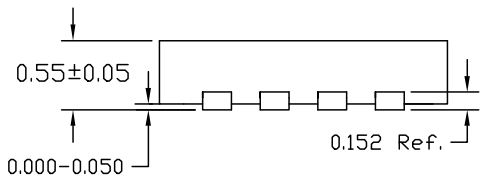

SIDE VIEW

NOTES :

1. ALL DIMENSIONS ARE IN MILLIMETERS.
2. MAX. PACKAGE WARPAGE IS 0.05 mm.
3. MAXIMUM ALLOWABLE BURRS IS 0.076 mm IN ALL DIRECTIONS.
4. PIN #1 ID ON TOP WILL BE LASER MARKED.

14-Pin (2.5mm x 2.5mm) Thin MLF® (MT)

MICREL, INC. 2180 FORTUNE DRIVE SAN JOSE, CA 95131 USA

TEL +1 (408) 944-0800 FAX +1 (408) 474-1000 WEB <http://www.micrel.com>

The information furnished by Micrel in this data sheet is believed to be accurate and reliable. However, no responsibility is assumed by Micrel for its use. Micrel reserves the right to change circuitry and specifications at any time without notification to the customer.

Micrel Products are not designed or authorized for use as components in life support appliances, devices or systems where malfunction of a product can reasonably be expected to result in personal injury. Life support devices or systems are devices or systems that (a) are intended for surgical implant into the body or (b) support or sustain life, and whose failure to perform can be reasonably expected to result in a significant injury to the user. A Purchaser's use or sale of Micrel Products for use in life support appliances, devices or systems is a Purchaser's own risk and Purchaser agrees to fully indemnify Micrel for any damages resulting from such use or sale.

© 2009 Micrel, Incorporated.