

GSID150A120T2C1

6-Pack IGBT Module



Features:

- Short Circuit Rated 10 μ s
- Low Saturation Voltage: $V_{CE(sat)} = 1.90V @ I_C = 150A, T_C=25^\circ C$
- Low Switching Loss
- 100% RBSOA Tested ($2 \times I_C$)
- Low Stray Inductance
- Lead Free, Compliant with RoHS Requirement



Applications:

- Industrial Inverters
- Servo Applications

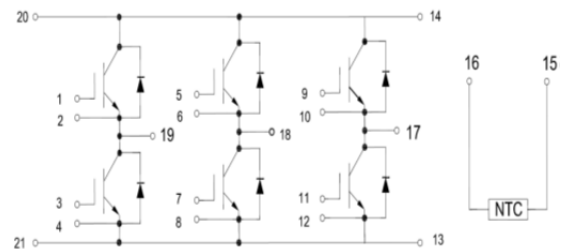

IGBT, Inverter

Maximum Rated Values ($T_C=25^\circ C$ unless otherwise specified)

V_{CES}	Collector-Emitter Blocking Voltage		1200	V
V_{GES}	Gate-Emitter Voltage		± 20	V
I_C	Continuous Collector Current	$T_C = 80^\circ C$	150	A
		$T_C = 25^\circ C$	285	A
$I_{CM(1)}$	Peak Collector Current Repetitive	$T_J = 175^\circ C$	300	A
t_{sc}	Short Circuit Withstand Time		>10	μs
P_D	Maximum Power Dissipation per IGBT	$T_C = 25^\circ C$ $T_{Jmax} = 175^\circ C$	1087	W

Electrical Characteristics of IGBT ($T_C=25^\circ\text{C}$ unless otherwise specified)

Static characteristics

Symbol	Description	Conditions	Min	Typ	Max	Unit
$V_{GE(th)}$	Gate-Emitter Threshold Voltage	$I_C = 1\text{ mA}, V_{CE} = V_{GE}$	5.0	5.5	6.0	V
$V_{CE(sat)}$	Collector-Emitter Saturation Voltage	$I_C = 150\text{A}, V_{GE} = 15\text{V}$	$T_J = 25^\circ\text{C}$	1.9	2.10	V
			$T_J = 125^\circ\text{C}$	2.20		
			$T_J = 150^\circ\text{C}$	2.30		V
I_{CES}	Collector-Emitter Leakage Current	$V_{GE} = 0\text{V}, V_{CE} = V_{CES}, T_J = 25^\circ\text{C}$			1	mA
I_{GES}	Gate-Emitter Leakage Current	$V_{GE} = \pm 20\text{V}, V_{CE} = 0\text{V}, T_J = 25^\circ\text{C}$			200	nA
C_{ies}	Input Capacitance	$V_{CE} = 25\text{V}, V_{GE} = 0\text{V}, f = 1\text{MHz}$		21.2		nF
C_{res}	Output capacitance			1.09		nF

Switching Characteristics

$t_{d(on)}$	Turn-on Delay Time	$V_{CC} = 600\text{V}, I_C = 10\text{A}, R_G = 15\Omega, V_{GE} = \pm 15\text{V}, \text{Inductive Load}$	$T_J = 25^\circ\text{C}$	735		ns
			$T_J = 125^\circ\text{C}$	720		
			$T_J = 150^\circ\text{C}$	720		
t_r	Rise Time		$T_J = 25^\circ\text{C}$	180		ns
			$T_J = 125^\circ\text{C}$	190		
			$T_J = 150^\circ\text{C}$	195		
$t_{d(off)}$	Turn-off Delay Time		$T_J = 25^\circ\text{C}$	630		ns
			$T_J = 125^\circ\text{C}$	655		
			$T_J = 150^\circ\text{C}$	675		
t_f	Fall Time		$T_J = 25^\circ\text{C}$	170		ns
		$T_J = 125^\circ\text{C}$	200			
		$T_J = 150^\circ\text{C}$	210			
E_{on}	Turn-on Switching Loss	$T_J = 25^\circ\text{C}$	19.7		mJ	
		$T_J = 125^\circ\text{C}$	23.3			
		$T_J = 150^\circ\text{C}$	24.8			
E_{off}	Turn-off Switching Loss	$T_J = 25^\circ\text{C}$	9.3		mJ	

Q _g	Total Gate Charge		T _J = 125°C		12.7		
			T _J = 150°C		14.7		
			T _J = 25°C		1650		nC
			T _J = 125°C		1665		
			T _J = 150°C		1672		
RBSOA	Reverse Bias Safe Operation Area	I _C =300A, V _{CC} =1050V, V _p =1200V, R _g = 15Ω, V _{GE} =+15V to 0V, T _J =150°C	Trapezoid				
SCSOA	Short Circuit Safe Operation Area	V _{CC} = 600V, V _{GE} = 15V, T _J = 150°C	10				μs
R _{θJC}	IGBT Thermal Resistance: Junction-To-Case			0.138			°C/W

Diode, Inverter

Maximum Rated Values (T_C=25°C unless otherwise specified)

V _{RRM}	Repetitive Peak Reverse Voltage	1200	V
I _F	Diode Continuous Forward Current	150	A
I _{FM}	Repetitive Peak Forward Current	300	A

Electrical Characteristics of FWD (T_C=25°C unless otherwise specified)

Symbol	Description	Conditions	Min	Typ	Max	Unit	
V _{FM}	Forward Voltage	I _F = 150A , V _{GE} = 0V	T _J = 25°C		2.30		V
			T _J = 125°C		2.40		
			T _J = 150°C		2.40		
I _{rr}	Peak Reverse Recovery Current		T _J = 25°C		50		A
			T _J = 125°C		65		
			T _J = 150°C		75		
Q _{rr}	Reverse Recovery Charge	I _F = 150A, di/dt = 900A/μs, V _{rr} = 600V, V _{GE} = -15V	T _J = 25°C		7.3		μC
			T _J = 125°C		14.3		
			T _J = 150°C		18.3		
E _{rec}	Reverse Recovery Energy		T _J = 25°C		2.0		mJ
			T _J = 125°C		4.3		

		$T_J = 150^\circ\text{C}$	5.8	
$R_{\theta JC}$	Diode Thermal Resistance: Junction-To-Case		0.258	$^\circ\text{C}/\text{W}$

Internal NTC-Thermistor Characteristics

Symbol	Description	Min	Typ	Max	Unit
R_{25}	$T_C = 25^\circ\text{C}$		5		$\text{k}\Omega$
$\Delta R/R$	$T_C = 100^\circ\text{C}$, $R_{100} = 481\Omega$			± 5	%
P_{25}	$T_C = 25^\circ\text{C}$		50		mW
$B_{25/50}$	$R_2 = R_{25} \exp[B_{25/50}(1/T_2 - 1/(298.15\text{K}))]$		3380		K
$B_{25/80}$	$R_2 = R_{25} \exp[B_{25/80}(1/T_2 - 1/(298.15\text{K}))]$		3440		K

Module

Symbol	Description	Min	Typ	Max	Unit
V_{iso}	Isolation Voltage(All Terminals Shorted) $f = 50\text{Hz}$, 1minute	2500			V
T_J	Maximum Junction Temperature			175	$^\circ\text{C}$
T_{JOP}	Maximum Operating Junction Temperature Range	-40		+150	$^\circ\text{C}$
T_{stg}	Storage Temperature	-40		+125	$^\circ\text{C}$
$R_{\theta CS}$	Case-To-Sink (Conductive Grease Applied)		0.02		$^\circ\text{C}/\text{W}$
M	Mounting Screw:M5	4.0		6.0	N·m
G	Weight		300		g

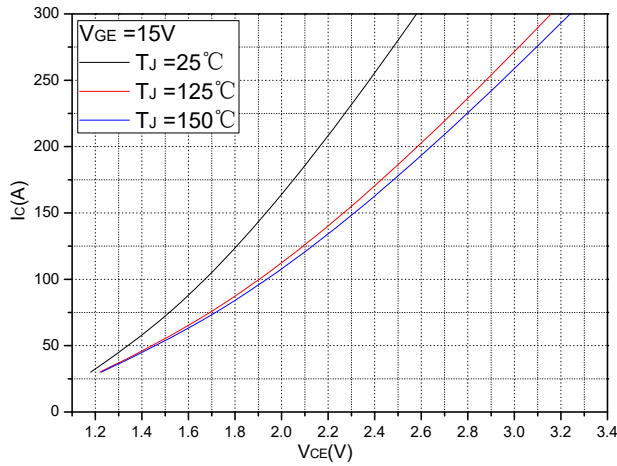

Fig.1 Typical Saturation Voltage Characteristics

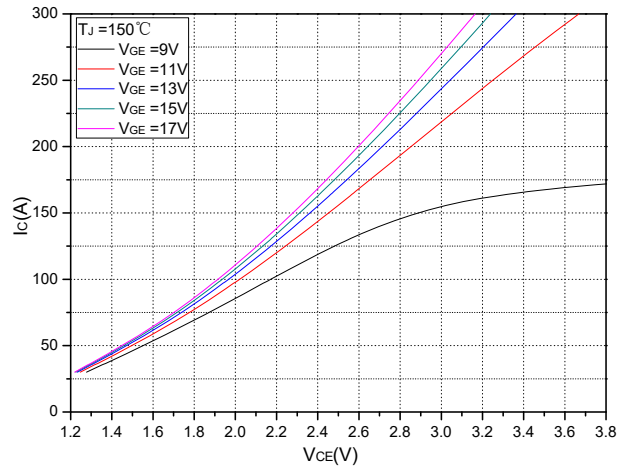

Fig.2 Typical Output Characteristics

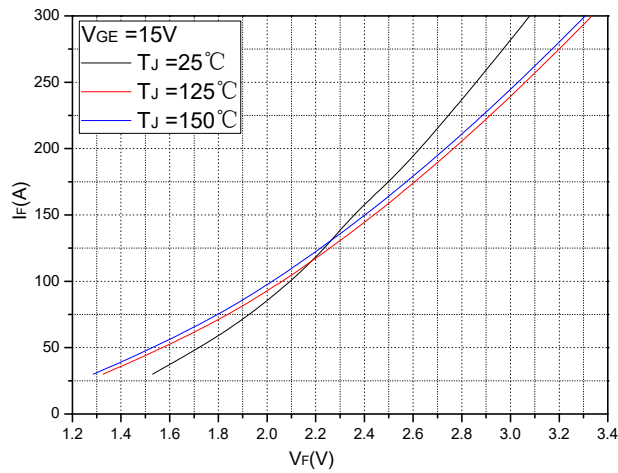

Fig.3 Forward Characteristics of FWD

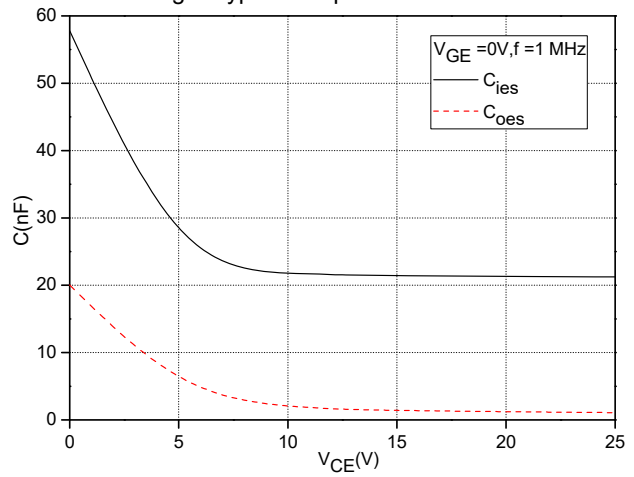

Fig.4 Capacitance Characteristics

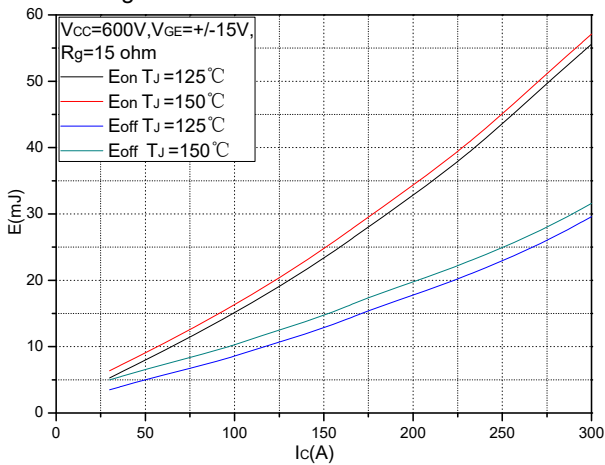

Fig.5 Typical Switching Loss vs. Collector Current

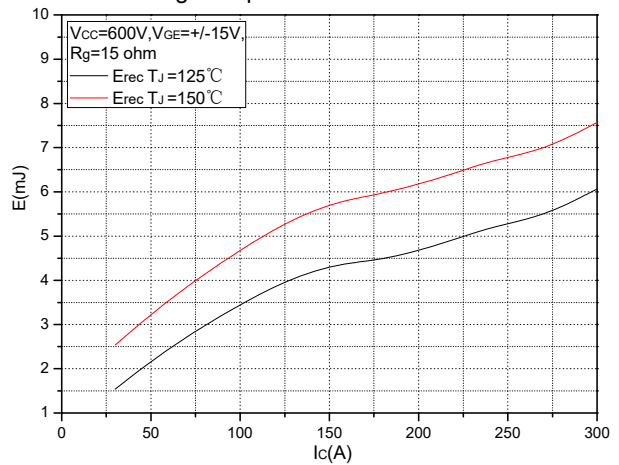

Fig.6 Typical Switching Loss vs. Collector Current

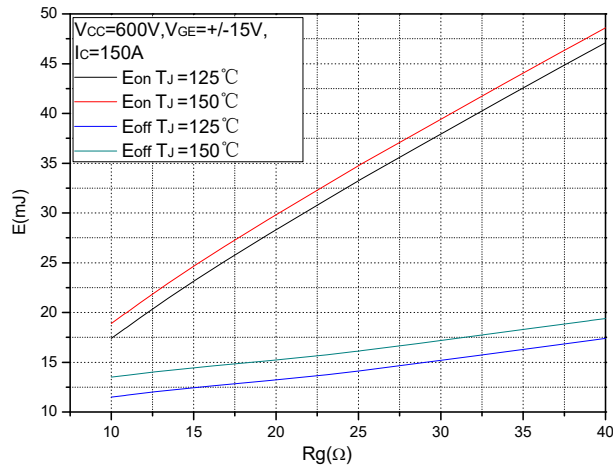

Fig.7 Typical Switching Losses vs. Gate Resistance

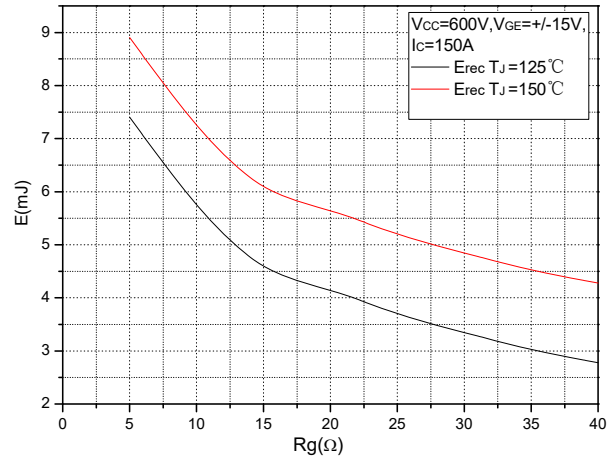

Fig.8 Typical Switching Losses vs. Gate Resistance

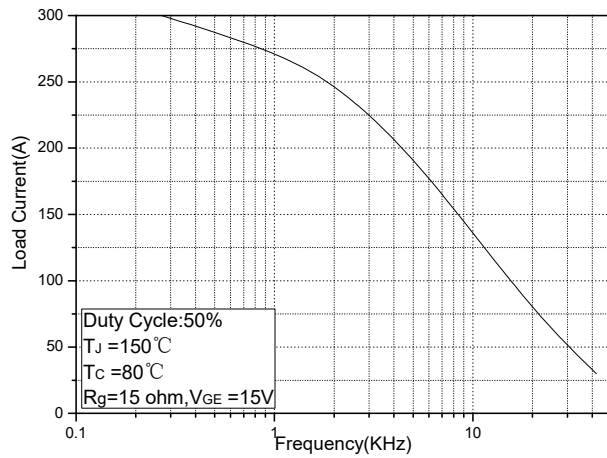

Fig.9 Typical Load Current vs. Frequency

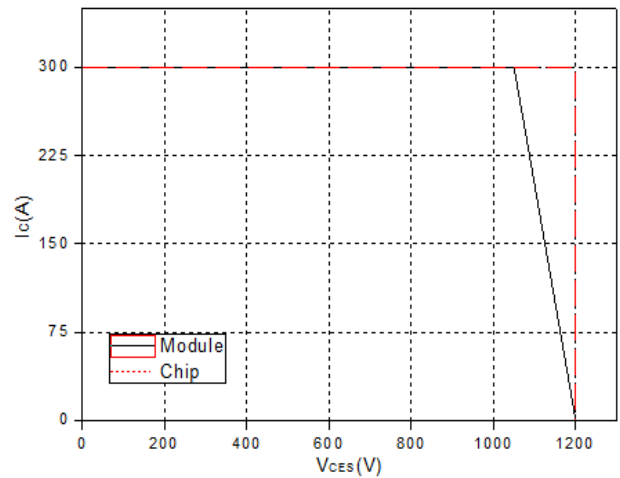

Fig.10 Reverse Bias Safe Operation Area (RBSOA)

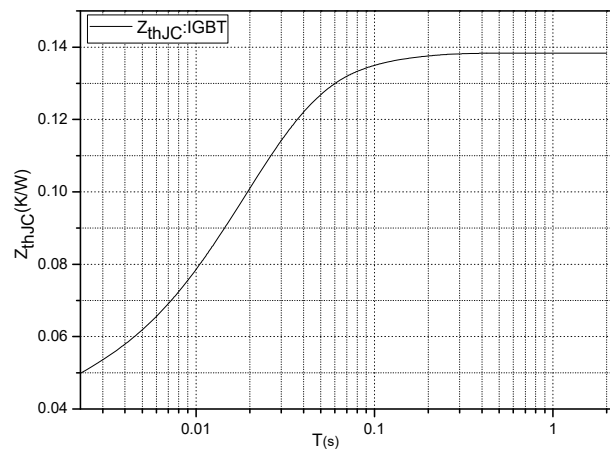

Fig.11 Transient thermal impedance (IGBT)

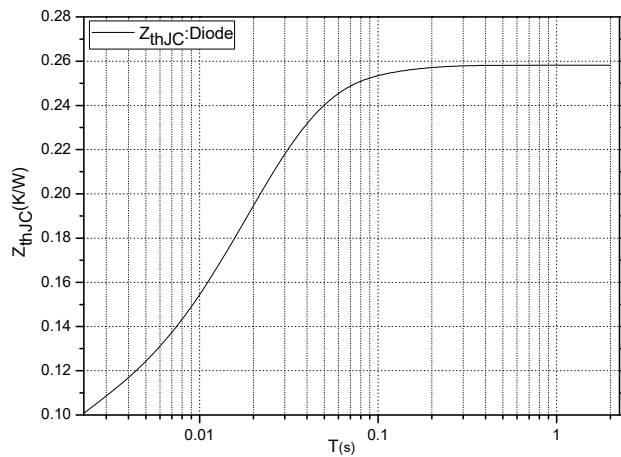

Fig.12 Transient thermal impedance (Diode)

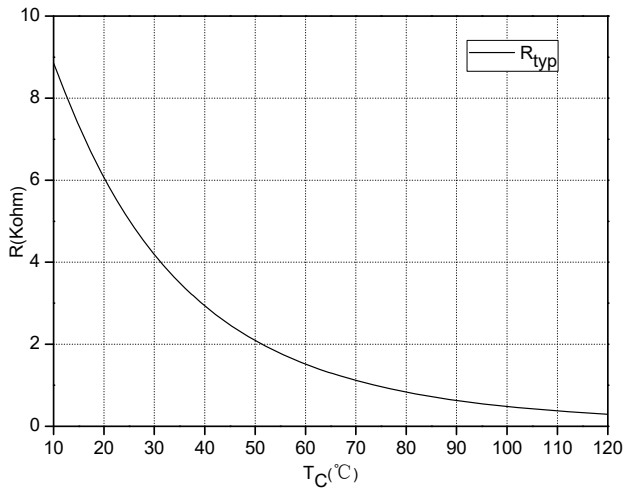
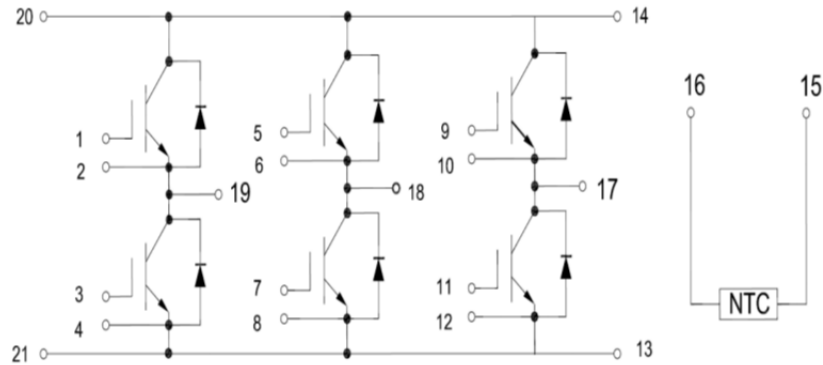
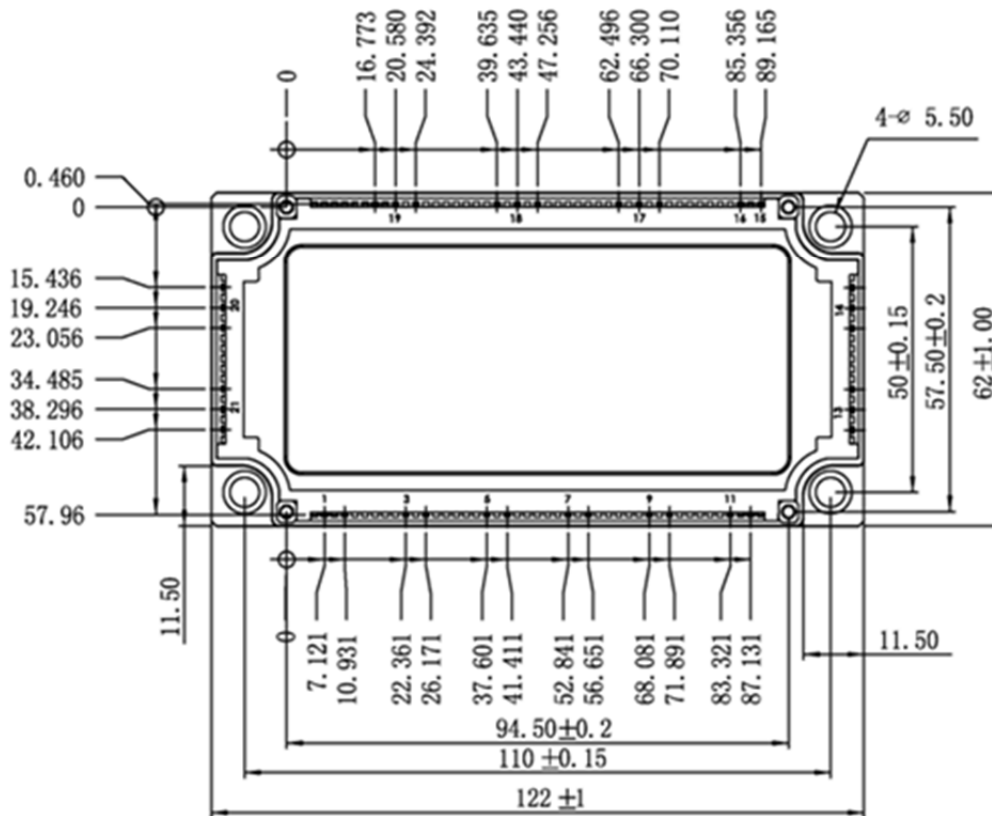
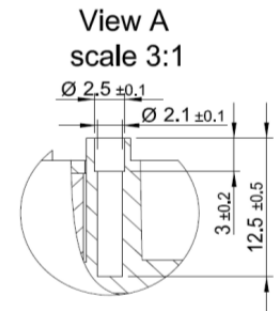
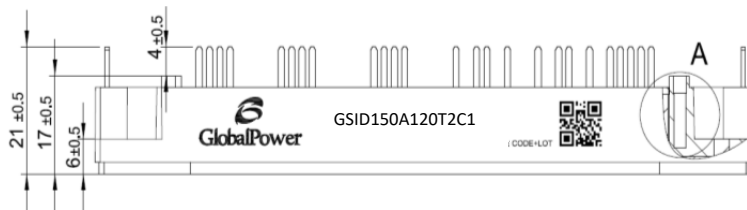

Fig.13 NTC Temperature characteristics

Internal Circuit:



Package Outline (Unit: mm):



Revision History

Date	Revision	Notes
06/15/2015	1.0	Initial release
11/17/2015	2.0	Add test data at junction temperature of 150 °C.
01/03/2020	2.1	Applied company name change

Notes

RoHS Compliance

The levels of RoHS restricted materials in this product are below the maximum concentration values (also referred to as the threshold limits) permitted for such substances, or are used in an exempted application, in accordance with EU Directive 2011/65/EC (RoHS2), as implemented March, 2013. RoHS Declarations for this product can be obtained from the Product Documentation sections of www.SemiQ.com.

REACH Compliance

REACH substances of high concern (SVHC) information is available for this product. Since the European Chemicals Agency (ECHA) has published notice of their intent to frequently revise the SVHC listing for the foreseeable future, please contact our office at SemiQ Headquarters in Lake Forest, California to insure you get the most up-to-date REACH SVHC Declaration. REACH banned substance information (REACH Article 67) is also available upon request.

SemiQ Inc., reserves the right to make changes to the product specifications and data in this document without notice. SemiQ products are sold pursuant to SemiQ's terms and conditions of sale in place at the time of order acknowledgement.

This product has not been designed or tested for use in, and is not intended for use in, applications implanted into the human body nor in applications in which failure of the product could lead to death, personal injury or property damage, including but not limited to equipment used in the operation of nuclear facilities, life-support machines, cardiac defibrillators or similar emergency medical equipment, aircraft navigation or communication or control systems, or air traffic control.

SemiQ makes no warranty, representation or guarantee regarding the suitability of its products for any particular purpose, nor does SemiQ assume any liability arising out of the application or use of any product or circuit, and specifically disclaims any and all liability, including without limitation special, consequential or incidental damages. Buyer is responsible for its products and applications using SemiQ products.

To obtain additional technical information or to place an order for this product, please contact us. The information in this datasheet is provided by SemiQ. SemiQ reserves the right to make changes, corrections, modifications, and improvements of datasheet without notice.