

FEATURES

- ▶ High performance at low power
- ▶ High speed
 - ▶ -3 dB bandwidth of 560 MHz, $G = 1$
 - ▶ 0.1 dB gain flatness to 300 MHz
 - ▶ Slew rate: 2800 V/ μ s, 25% to 75%
 - ▶ Fast 0.1% settling time of 9 ns
- ▶ Low power: 9.6 mA per amplifier
- ▶ Low harmonic distortion
 - ▶ 100 dB SFDR at 10 MHz
 - ▶ 90 dB SFDR at 20 MHz
- ▶ Low input voltage noise: 3.6 nV/ $\sqrt{\text{Hz}}$
- ▶ ± 0.5 mV typical input offset voltage
- ▶ Externally adjustable gain
- ▶ Can be used with gains less than 1
- ▶ Differential-to-differential or single-ended-to-differential operation
- ▶ Adjustable output common-mode voltage
- ▶ Input common-mode range shifted down by $1 V_{BE}$
- ▶ Wide supply range: +3 V to ± 5 V
- ▶ Available in 16-lead and 24-lead LFCSP packages

APPLICATIONS

- ▶ ADC drivers
- ▶ Single-ended-to-differential converters
- ▶ IF and baseband gain blocks
- ▶ Differential buffers
- ▶ Line drivers

GENERAL DESCRIPTION

The ADA4932-1/ADA4932-2 are the next generation AD8132 with higher performance and lower noise and power consumption. They are an ideal choice for driving high performance ADCs as a single-ended-to-differential or differential-to-differential amplifier. The output common-mode voltage is user adjustable by means of an internal common-mode feedback loop, allowing the ADA4932-1/ADA4932-2 output to match the input of the ADC. The internal feedback loop also provides exceptional output balance as well as suppression of even-order harmonic distortion products.

With the ADA4932-1/ADA4932-2, differential gain configurations are easily realized with a simple external four-resistor feedback network that determines the closed-loop gain of the amplifier.

The ADA4932-1/ADA4932-2 were fabricated using the Analog Devices, Inc., proprietary silicon-germanium (SiGe) complementary

FUNCTIONAL BLOCK DIAGRAM

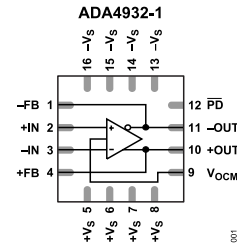

Figure 1. ADA4932-1

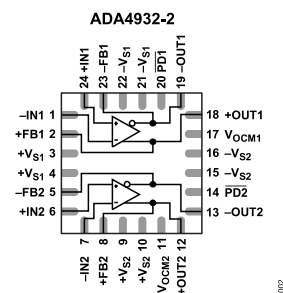

Figure 2. ADA4932-2

bipolar process, enabling it to achieve low levels of distortion and noise at low power consumption.

The low offset and excellent dynamic performance of the ADA4932-1/ADA4932-2 make them well suited for a wide variety of data acquisition and signal processing applications.

The ADA4932-1 is available in a 16-lead LFCSP, and the ADA4932-2 is available in a 24-lead LFCSP. The pinouts are optimized to facilitate the printed circuit board (PCB) layout and minimize distortion. The ADA4932-1/ADA4932-2 are specified to operate over the -40°C to $+105^{\circ}\text{C}$ temperature range; both operate on supplies between +3 V and ± 5 V.

TABLE OF CONTENTS

Features.....	1	Applications Information.....	20
Applications.....	1	Analyzing an Application Circuit.....	20
Functional Block Diagram.....	1	Setting the Closed-Loop Gain.....	20
General Description.....	1	Estimating the Output Noise Voltage	20
Specifications.....	3	Impact of Mismatches in the Feedback	
±5 V Operation	3	Networks.....	21
5 V Operation	5	Calculating the Input Impedance for an	
Absolute Maximum Ratings.....	7	Application Circuit.....	21
Thermal Resistance.....	7	Input Common-Mode Voltage Range	23
Maximum Power Dissipation.....	7	Input and Output Capacitive AC Coupling.....	23
ESD Caution.....	7	Setting the Output Common-Mode Voltage	23
Pin Configurations and Function Descriptions.....	8	High Performance Precision ADC Driver.....	23
Typical Performance Characteristics.....	9	High Performance ADC Driving.....	25
Test Circuits.....	17	Layout, Grounding, and Bypassing.....	26
Terminology.....	18	Outline Dimensions.....	27
Theory of Operation.....	19	Ordering Guide.....	27

REVISION HISTORY**4/2022—Rev. E to Rev. F**

Changes to \overline{PD} Input Voltage Parameter and \overline{PD} Pin Bias Current per Amplifier Parameter, Table 3.....	4
Changes to \overline{PD} Input Voltage Parameter and \overline{PD} Pin Bias Current per Amplifier Parameter, Table 6.....	6
Updated Outline Dimensions.....	27

SPECIFICATIONS

±5 V OPERATION

$T_A = 25^\circ\text{C}$, $+V_S = 5\text{ V}$, $-V_S = -5\text{ V}$, $V_{\text{OCM}} = 0\text{ V}$, $R_F = 499\ \Omega$, $R_G = 499\ \Omega$, $R_T = 53.6\ \Omega$ (when used), $R_{L, \text{dm}} = 1\text{ k}\Omega$, unless otherwise noted. All specifications refer to single-ended input and differential outputs, unless otherwise noted. Refer to [Figure 54](#) for signal definitions.

±D_{IN} to V_{OUT, dm} Performance

Table 1.

Parameter	Test Conditions/Comments	Min	Typ	Max	Unit
DYNAMIC PERFORMANCE					
-3 dB Small Signal Bandwidth	$V_{\text{OUT, dm}} = 0.1\text{ V p-p}$		560		MHz
	$V_{\text{OUT, dm}} = 0.1\text{ V p-p}$, $R_F = R_G = 205\ \Omega$		1000		MHz
-3 dB Large Signal Bandwidth	$V_{\text{OUT, dm}} = 2.0\text{ V p-p}$		360		MHz
	$V_{\text{OUT, dm}} = 2.0\text{ V p-p}$, $R_F = R_G = 205\ \Omega$		360		MHz
Bandwidth for 0.1 dB Flatness	$V_{\text{OUT, dm}} = 2.0\text{ V p-p}$, ADA4932-1, $R_L = 200\ \Omega$		300		MHz
	$V_{\text{OUT, dm}} = 2.0\text{ V p-p}$, ADA4932-2, $R_L = 200\ \Omega$		100		MHz
Slew Rate	$V_{\text{OUT, dm}} = 2\text{ V p-p}$, 25% to 75%		2800		V/ μs
Settling Time to 0.1%	$V_{\text{OUT, dm}} = 2\text{ V step}$		9		ns
Overdrive Recovery Time	$V_{\text{IN}} = 0\text{ V to }5\text{ V ramp}$, $G = 2$		20		ns
NOISE/HARMONIC PERFORMANCE					
See Figure 53 for distortion test circuit					
Second Harmonic	$V_{\text{OUT, dm}} = 2\text{ V p-p}$, 1 MHz		-110		dBc
	$V_{\text{OUT, dm}} = 2\text{ V p-p}$, 10 MHz		-100		dBc
	$V_{\text{OUT, dm}} = 2\text{ V p-p}$, 20 MHz		-90		dBc
	$V_{\text{OUT, dm}} = 2\text{ V p-p}$, 50 MHz		-72		dBc
Third Harmonic	$V_{\text{OUT, dm}} = 2\text{ V p-p}$, 1 MHz		-130		dBc
	$V_{\text{OUT, dm}} = 2\text{ V p-p}$, 10 MHz		-120		dBc
	$V_{\text{OUT, dm}} = 2\text{ V p-p}$, 20 MHz		-105		dBc
	$V_{\text{OUT, dm}} = 2\text{ V p-p}$, 50 MHz		-80		dBc
IMD	$f_1 = 30\text{ MHz}$, $f_2 = 30.1\text{ MHz}$, $V_{\text{OUT, dm}} = 2\text{ V p-p}$		-91		dBc
Voltage Noise (RTI)	$f = 1\text{ MHz}$		3.6		nV/ $\sqrt{\text{Hz}}$
Input Current Noise	$f = 1\text{ MHz}$		1.0		pA/ $\sqrt{\text{Hz}}$
Crosstalk	$f = 10\text{ MHz}$, ADA4932-2		-100		dB
INPUT CHARACTERISTICS					
Offset Voltage	$V_{+\text{DIN}} = V_{-\text{DIN}} = V_{\text{OCM}} = 0\text{ V}$	-2.2	±0.5	+2.2	mV
	T_{MIN} to T_{MAX} variation		-3.7		$\mu\text{V}/^\circ\text{C}$
Input Bias Current		-5.2	-2.5	-0.1	μA
	T_{MIN} to T_{MAX} variation		-9.5		nA/ $^\circ\text{C}$
Input Offset Current		-0.2	±0.025	+0.2	μA
Input Resistance	Differential		11		M Ω
	Common mode		16		M Ω
Input Capacitance			0.5		pF
Input Common-Mode Voltage Range			$-V_S + 0.2$ to $+V_S - 1.8$		V
CMRR	$\Delta V_{\text{OUT, dm}}/\Delta V_{\text{IN, cm}}$, $\Delta V_{\text{IN, cm}} = \pm 1\text{ V}$		-100	-87	dB
Open-Loop Gain		64	66		dB
OUTPUT CHARACTERISTICS					

SPECIFICATIONS

Table 1.

Parameter	Test Conditions/Comments	Min	Typ	Max	Unit
Output Voltage Swing	Maximum ΔV_{OUT} , single-ended output, $R_F = R_G = 10\text{ k}\Omega$, $R_L = 1\text{ k}\Omega$	$-V_S + 1.4$ to $+V_S - 1.4$	$-V_S + 1.2$ to $+V_S - 1.2$		V
Linear Output Current	200 kHz, $R_{L, dm} = 10\ \Omega$, SFDR = 68 dB		80		mA rms
Output Balance Error	$\Delta V_{OUT, cm}/\Delta V_{OUT, dm}$, $\Delta V_{OUT, dm} = 2\text{ V p-p}$, 1 MHz, see Figure 52 for output balance test circuit		-64	-60	dB

 V_{OCM} to $V_{OUT, cm}$ Performance

Table 2.

Parameter	Test Conditions/Comments	Min	Typ	Max	Unit
V_{OCM} DYNAMIC PERFORMANCE					
-3 dB Small Signal Bandwidth	$V_{OUT, cm} = 100\text{ mV p-p}$		270		MHz
-3 dB Large Signal Bandwidth	$V_{OUT, cm} = 2\text{ V p-p}$		105		MHz
Slew Rate	$V_{IN} = 1.5\text{ V to }3.5\text{ V}$, 25% to 75%		410		V/ μ s
Input Voltage Noise (RTI)	$f = 1\text{ MHz}$		9.6		nV/ $\sqrt{\text{Hz}}$
V_{OCM} INPUT CHARACTERISTICS					
Input Voltage Range			$-V_S + 1.2$ to $+V_S - 1.2$		V
Input Resistance		22	25	29	k Ω
Input Offset Voltage	$V_{+DIN} = V_{-DIN} = 0\text{ V}$	-5.1	± 1	+5.1	mV
V_{OCM} CMRR	$\Delta V_{OUT, dm}/\Delta V_{OCM}$, $\Delta V_{OCM} = \pm 1\text{ V}$		-100	-86	dB
Gain	$\Delta V_{OUT, cm}/\Delta V_{OCM}$, $\Delta V_{OCM} = \pm 1\text{ V}$	0.995	0.998	1.000	V/V

General Performance

Table 3.

Parameter	Test Conditions/Comments	Min	Typ	Max	Unit
POWER SUPPLY					
Operating Range		3.0		11	V
Quiescent Current per Amplifier		9.0	9.6	10.1	mA
	T_{MIN} to T_{MAX} variation		35		μ A/ $^{\circ}$ C
	Powered down		0.9	1.0	mA
Power Supply Rejection Ratio	$\Delta V_{OUT, dm}/\Delta V_S$, $\Delta V_S = 1\text{ V p-p}$		-96	-84	dB
POWER-DOWN ($\overline{\text{PD}}$)					
$\overline{\text{PD}}$ Input Voltage	Powered down		$\leq (+V_S - 2.8)$		V
	Enabled		$\geq (+V_S - 2.2)$		V
Turn-Off Time			1100		ns
Turn-On Time			16		ns
$\overline{\text{PD}}$ Pin Bias Current per Amplifier					μ A
Enabled	$\overline{\text{PD}} = 5\text{ V}$	-1	+0.25	+1	μ A
Disabled	$\overline{\text{PD}} = -5\text{ V}$	-165	-120	-65	μ A
OPERATING TEMPERATURE RANGE					
		-40		+105	$^{\circ}$ C

SPECIFICATIONS

5 V OPERATION

$T_A = 25^\circ\text{C}$, $+V_S = 5\text{ V}$, $-V_S = 0\text{ V}$, $V_{\text{OCM}} = 2.5\text{ V}$, $R_F = 499\ \Omega$, $R_G = 499\ \Omega$, $R_T = 53.6\ \Omega$ (when used), $R_{L, \text{dm}} = 1\text{ k}\Omega$, unless otherwise noted. All specifications refer to single-ended input and differential outputs, unless otherwise noted. Refer to [Figure 54](#) for signal definitions.

 $\pm D_{\text{IN}}$ to $V_{\text{OUT, dm}}$ Performance

Table 4.

Parameter	Test Conditions/Comments	Min	Typ	Max	Unit
DYNAMIC PERFORMANCE					
-3 dB Small Signal Bandwidth	$V_{\text{OUT, dm}} = 0.1\text{ V p-p}$		560		MHz
	$V_{\text{OUT, dm}} = 0.1\text{ V p-p}$, $R_F = R_G = 205\ \Omega$		990		MHz
-3 dB Large Signal Bandwidth	$V_{\text{OUT, dm}} = 2.0\text{ V p-p}$		315		MHz
	$V_{\text{OUT, dm}} = 2.0\text{ V p-p}$, $R_F = R_G = 205\ \Omega$		320		MHz
Bandwidth for 0.1 dB Flatness	$V_{\text{OUT, dm}} = 2.0\text{ V p-p}$, ADA4932-1, $R_L = 200\ \Omega$		120		MHz
	$V_{\text{OUT, dm}} = 2.0\text{ V p-p}$, ADA4932-2, $R_L = 200\ \Omega$		200		MHz
Slew Rate	$V_{\text{OUT, dm}} = 2\text{ V p-p}$, 25% to 75%		2200		V/ μs
Settling Time to 0.1%	$V_{\text{OUT, dm}} = 2\text{ V step}$		10		ns
Overdrive Recovery Time	$V_{\text{IN}} = 0\text{ V to }2.5\text{ V ramp}$, $G = 2$		20		ns
NOISE/HARMONIC PERFORMANCE					
Second Harmonic	$V_{\text{OUT, dm}} = 2\text{ V p-p}$, 1 MHz		-110		dBc
	$V_{\text{OUT, dm}} = 2\text{ V p-p}$, 10 MHz		-100		dBc
	$V_{\text{OUT, dm}} = 2\text{ V p-p}$, 20 MHz		-90		dBc
	$V_{\text{OUT, dm}} = 2\text{ V p-p}$, 50 MHz		-72		dBc
Third Harmonic	$V_{\text{OUT, dm}} = 2\text{ V p-p}$, 1 MHz		-120		dBc
	$V_{\text{OUT, dm}} = 2\text{ V p-p}$, 10 MHz		-100		dBc
	$V_{\text{OUT, dm}} = 2\text{ V p-p}$, 20 MHz		-87		dBc
	$V_{\text{OUT, dm}} = 2\text{ V p-p}$, 50 MHz		-70		dBc
IMD	$f_1 = 30\text{ MHz}$, $f_2 = 30.1\text{ MHz}$, $V_{\text{OUT, dm}} = 2\text{ V p-p}$		-91		dBc
Voltage Noise (RTI)	$f = 1\text{ MHz}$		3.6		nV/ $\sqrt{\text{Hz}}$
Input Current Noise	$f = 1\text{ MHz}$		1.0		pA/ $\sqrt{\text{Hz}}$
Crosstalk	$f = 10\text{ MHz}$, ADA4932-2		-100		dB
INPUT CHARACTERISTICS					
Offset Voltage	$V_{+DIN} = V_{-DIN} = V_{\text{OCM}} = 2.5\text{ V}$	-2.2	± 0.5	+2.2	mV
	T_{MIN} to T_{MAX} variation		-3.7		$\mu\text{V}/^\circ\text{C}$
Input Bias Current		-5.3	-3.0	-0.23	μA
	T_{MIN} to T_{MAX} variation		-9.5		nA/ $^\circ\text{C}$
Input Offset Current		-0.25	± 0.025	+0.25	μA
Input Resistance	Differential		11		M Ω
	Common mode		16		M Ω
Input Capacitance			0.5		pF
Input Common-Mode Voltage Range			$-V_S + 0.2$ to		V
			$+V_S - 1.8$		
CMRR	$\Delta V_{\text{OUT, dm}}/\Delta V_{\text{IN, cm}}$, $\Delta V_{\text{IN, cm}} = \pm 1\text{ V}$		-100	-87	dB
Open-Loop Gain		64	66		dB
OUTPUT CHARACTERISTICS					

SPECIFICATIONS

Table 4.

Parameter	Test Conditions/Comments	Min	Typ	Max	Unit
Output Voltage Swing	Maximum ΔV_{OUT} , single-ended output, $R_F = R_G = 10$ k Ω , $R_L = 1$ k Ω	$-V_S + 1.15$ to $+V_S - 1.15$	$-V_S + 1.02$ to $+V_S - 1.02$		V
Linear Output Current	200 kHz, $R_{L, dm} = 10$ Ω , SFDR = 67 dB		53		mA rms
Output Balance Error	$\Delta V_{OUT, cm}/\Delta V_{OUT, dm}$, $\Delta V_{OUT, dm} = 1$ V p-p, 1 MHz, see Figure 52 for output balance test circuit		-64	-60	dB

 V_{OCM} to $V_{OUT, cm}$ Performance

Table 5.

Parameter	Test Conditions/Comments	Min	Typ	Max	Unit
V_{OCM} DYNAMIC PERFORMANCE					
-3 dB Small Signal Bandwidth	$V_{OUT, cm} = 100$ mV p-p		260		MHz
-3 dB Large Signal Bandwidth	$V_{OUT, cm} = 2$ V p-p		90		MHz
Slew Rate	$V_{IN} = 1.5$ V to 3.5 V, 25% to 75%		360		V/ μ s
Input Voltage Noise (RTI)	$f = 1$ MHz		9.6		nV/ $\sqrt{\text{Hz}}$
V_{OCM} INPUT CHARACTERISTICS					
Input Voltage Range			$-V_S + 1.2$ to $+V_S - 1.2$		V
Input Resistance		22	25	29	k Ω
Input Offset Voltage	$V_{+DIN} = V_{-DIN} = 2.5$ V	-6.5	-3.0	+6.5	mV
V_{OCM} CMRR	$\Delta V_{OUT, dm}/\Delta V_{OCM}$, $\Delta V_{OCM} = \pm 1$ V		-100	-86	dB
Gain	$\Delta V_{OUT, cm}/\Delta V_{OCM}$, $\Delta V_{OCM} = \pm 1$ V	0.995	0.998	1.000	V/V

General Performance

Table 6.

Parameter	Test Conditions/Comments	Min	Typ	Max	Unit
POWER SUPPLY					
Operating Range		3.0		11	V
Quiescent Current per Amplifier		8.2	8.8	9.5	mA
	T_{MIN} to T_{MAX} variation		35		μ A/ $^{\circ}$ C
	Powered down		0.7	0.8	mA
Power Supply Rejection Ratio	$\Delta V_{OUT, dm}/\Delta V_S$, $\Delta V_S = 1$ V p-p		-96	-84	dB
POWER-DOWN (\overline{PD})					
\overline{PD} Input Voltage	Powered down		$\leq (+V_S - 2.8)$		V
	Enabled		$\geq (+V_S - 2.2)$		V
Turn-Off Time			1100		ns
Turn-On Time			16		ns
\overline{PD} Pin Bias Current per Amplifier					μ A
Enabled	$\overline{PD} = 5$ V	-1	+0.25	+1	μ A
Disabled	$\overline{PD} = 0$ V	-75	-45	-15	μ A
OPERATING TEMPERATURE RANGE		-40		+105	$^{\circ}$ C

ABSOLUTE MAXIMUM RATINGS

Table 7.

Parameter	Rating
Supply Voltage	11 V
Power Dissipation	See Figure 3
Input Current, +IN, -IN, \overline{PD}	± 5 mA
Storage Temperature Range	-65°C to +125°C
Operating Temperature Range	
ADA4932-1	-40°C to +105°C
ADA4932-2	-40°C to +105°C
Lead Temperature (Soldering, 10 sec)	300°C
Junction Temperature	150°C

Stresses at or above those listed under Absolute Maximum Ratings may cause permanent damage to the product. This is a stress rating only; functional operation of the product at these or any other conditions above those indicated in the operational section of this specification is not implied. Operation beyond the maximum operating conditions for extended periods may affect product reliability.

THERMAL RESISTANCE

θ_{JA} is specified for the device (including exposed pad) soldered to a high thermal conductivity 2s2p circuit board, as described in EIA/JESD 51-7.

Table 8. Thermal Resistance

Package Type	θ_{JA}	Unit
ADA4932-1, 16-Lead LFCSP (Exposed Pad)	91	°C/W
ADA4932-2, 24-Lead LFCSP (Exposed Pad)	65	°C/W

MAXIMUM POWER DISSIPATION

The maximum safe power dissipation for the ADA4932-1/ADA4932-2 package is limited by the associated rise in junction temperature (T_J) on the die. At approximately 150°C, which is the glass transition temperature, the plastic changes its properties. Even temporarily exceeding this temperature limit can change the stresses that the package exerts on the die, permanently shifting the parametric performance of the ADA4932-1/ADA4932-2. Exceeding a junction temperature of 150°C for an extended period can result in changes in the silicon devices, potentially causing failure.

The power dissipated in the package (P_D) is the sum of the quiescent power dissipation and the power dissipated in the package due to the load drive. The quiescent power is the voltage between the supply pins (V_S) times the quiescent current (I_S). The power dissipated due to the load drive depends upon the particular application. The power due to load drive is calculated by multiplying the load current by the associated voltage drop across the device. RMS voltages and currents must be used in these calculations.

Airflow increases heat dissipation, effectively reducing θ_{JA} . In addition, more metal directly in contact with the package leads/ exposed pad from metal traces, through holes, ground, and power planes reduces θ_{JA} .

Figure 3 shows the maximum safe power dissipation in the package vs. the ambient temperature for the single 16-lead LFCSP (91°C/W) and the dual 24-lead LFCSP (65°C/W) on a JEDEC standard 4-layer board with the exposed pad soldered to a PCB pad that is connected to a solid plane.

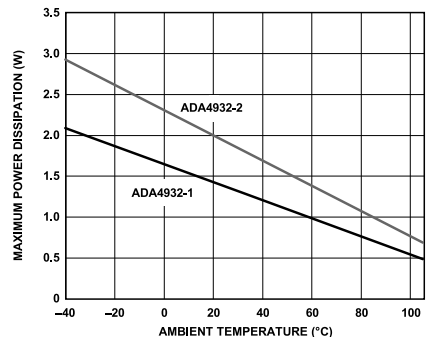

Figure 3. Maximum Power Dissipation vs. Ambient Temperature for a 4-Layer Board

ESD CAUTION



ESD (electrostatic discharge) sensitive device. Charged devices and circuit boards can discharge without detection. Although this product features patented or proprietary protection circuitry, damage may occur on devices subjected to high energy ESD. Therefore, proper ESD precautions should be taken to avoid performance degradation or loss of functionality.

PIN CONFIGURATIONS AND FUNCTION DESCRIPTIONS

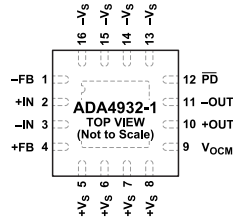

NOTES
1. SOLDER EXPOSED PADDLE ON BACK OF PACKAGE TO GROUND PLANE OR TO A POWER PLANE.

Figure 4. ADA4932-1 Pin Configuration

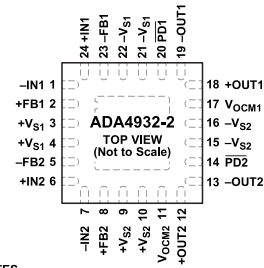

NOTES
1. SOLDER EXPOSED PADDLE ON BACK OF PACKAGE TO GROUND PLANE OR TO A POWER PLANE.

Figure 5. ADA4932-2 Pin Configuration

Table 9. ADA4932-1 Pin Function Descriptions

Pin No.	Mnemonic	Description
1	-FB	Negative Output for Feedback Component Connection.
2	+IN	Positive Input Summing Node.
3	-IN	Negative Input Summing Node.
4	+FB	Positive Output for Feedback Component Connection.
5 to 8	+V _S	Positive Supply Voltage.
9	V _{OCM}	Output Common-Mode Voltage.
10	+OUT	Positive Output for Load Connection.
11	-OUT	Negative Output for Load Connection.
12	$\overline{\text{PD}}$	Power-Down Pin.
13 to 16	-V _S	Negative Supply Voltage.
17	Exposed Paddle (EPAD)	Solder the exposed paddle on the back of the package to a ground plane or to a power plane.

Table 10. ADA4932-2 Pin Function Descriptions

Pin No.	Mnemonic	Description
1	-IN1	Negative Input Summing Node 1.
2	+FB1	Positive Output Feedback 1.
3, 4	+V _{S1}	Positive Supply Voltage 1.
5	-FB2	Negative Output Feedback 2.
6	+IN2	Positive Input Summing Node 2.
7	-IN2	Negative Input Summing Node 2.
8	+FB2	Positive Output Feedback 2.
9, 10	+V _{S2}	Positive Supply Voltage 2.
11	V _{OCM2}	Output Common-Mode Voltage 2.
12	+OUT2	Positive Output 2.
13	-OUT2	Negative Output 2.
14	$\overline{\text{PD}}_2$	Power-Down Pin 2.
15, 16	-V _{S2}	Negative Supply Voltage 2.
17	V _{OCM1}	Output Common-Mode Voltage 1.
18	+OUT1	Positive Output 1.
19	-OUT1	Negative Output 1.
20	$\overline{\text{PD}}_1$	Power-Down Pin 1.
21, 22	-V _{S1}	Negative Supply Voltage 1.
23	-FB1	Negative Output Feedback 1.
24	+IN1	Positive Input Summing Node 1.
25	Exposed Paddle (EPAD)	Solder the exposed paddle on the back of the package to a ground plane or to a power plane.

TYPICAL PERFORMANCE CHARACTERISTICS

$T_A = 25^\circ\text{C}$, $+V_S = 5\text{ V}$, $-V_S = -5\text{ V}$, $V_{\text{OCM}} = 0\text{ V}$, $R_G = 499\ \Omega$, $R_F = 499\ \Omega$, $R_T = 53.6\ \Omega$ (when used), $R_{L, \text{dm}} = 1\text{ k}\Omega$, unless otherwise noted. Refer to Figure 51 for test setup. Refer to Figure 54 for signal definitions.

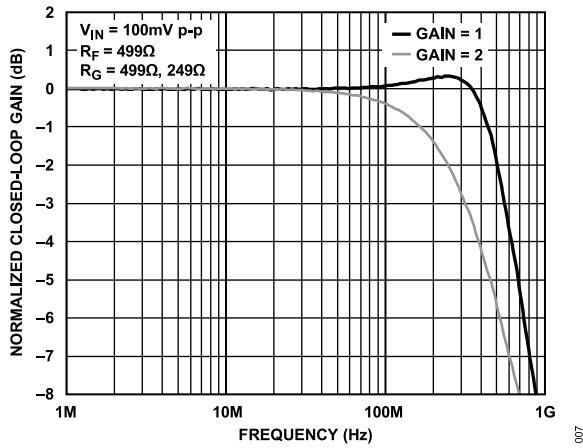

Figure 6. Small Signal Frequency Response for Various Gains

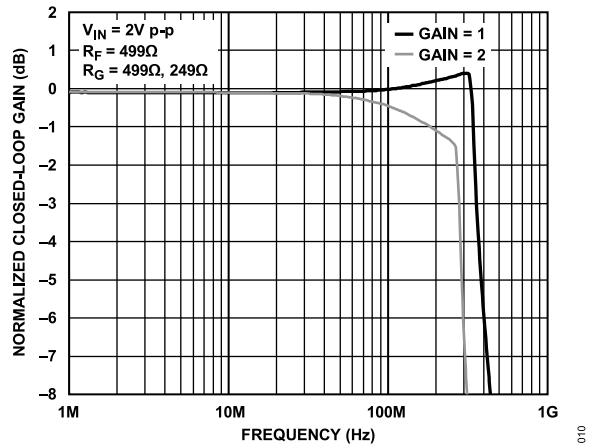

Figure 9. Large Signal Frequency Response for Various Gains

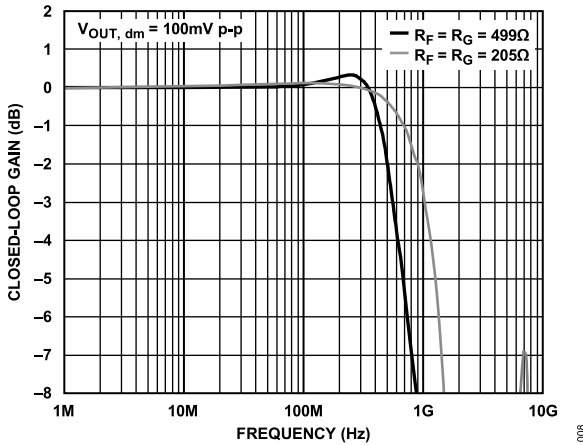

Figure 7. Small Signal Frequency Response for Various R_F and R_G

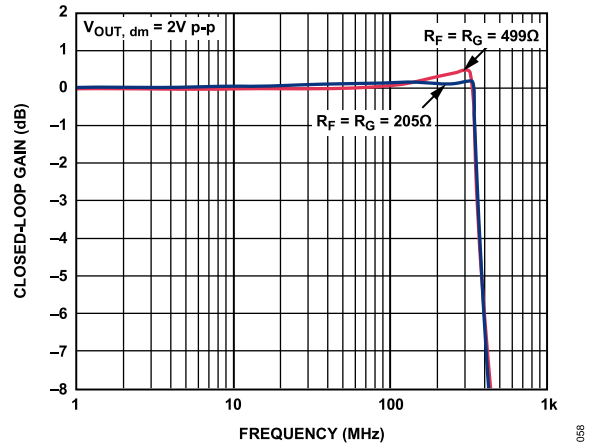

Figure 10. Large Signal Frequency Response for Various R_F and R_G

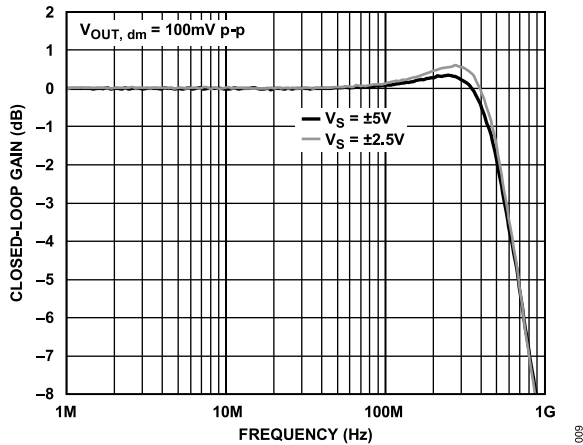

Figure 8. Small Signal Frequency Response for Various Supplies

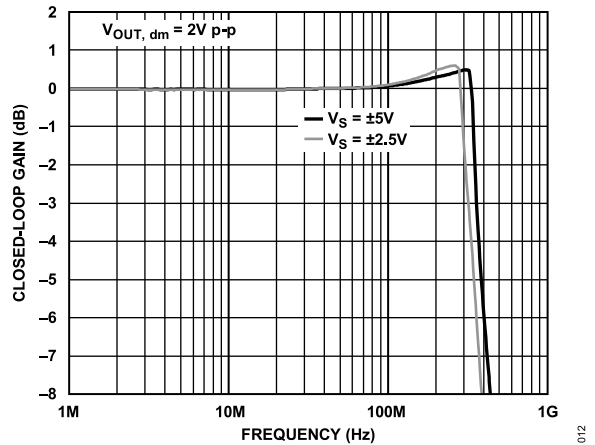

Figure 11. Large Signal Frequency Response for Various Supplies

TYPICAL PERFORMANCE CHARACTERISTICS

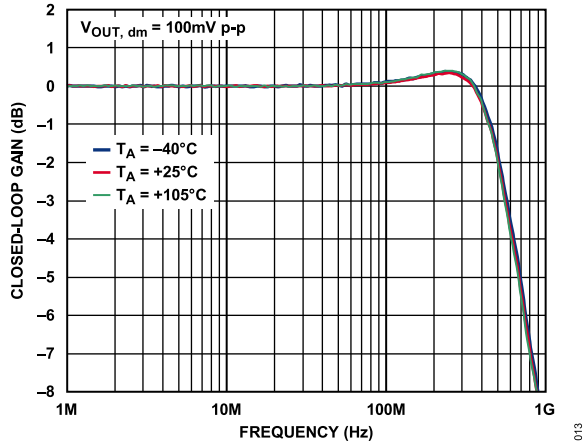

Figure 12. Small Signal Frequency Response for Various Temperatures

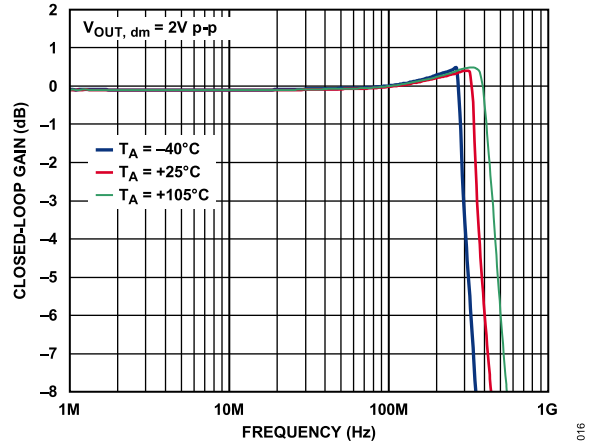

Figure 15. Large Signal Frequency Response for Various Temperatures

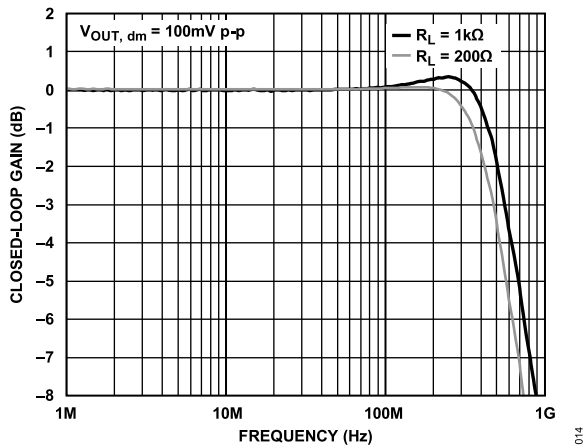

Figure 13. Small Signal Frequency Response at Various Loads

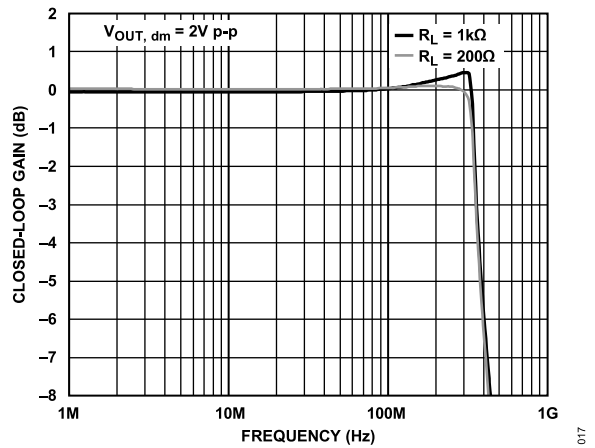

Figure 16. Large Signal Frequency Response at Various Loads

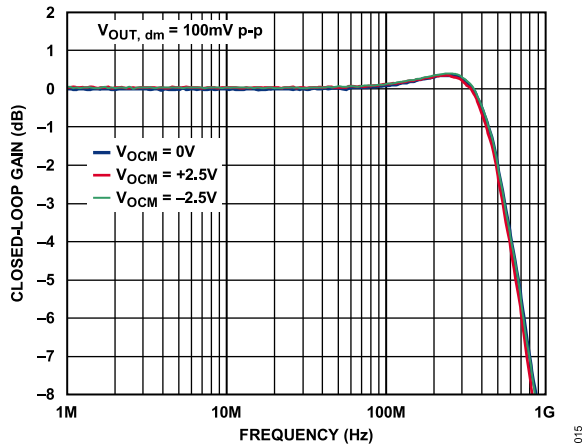

Figure 14. Small Signal Frequency Response for Various V_{OCM} Levels

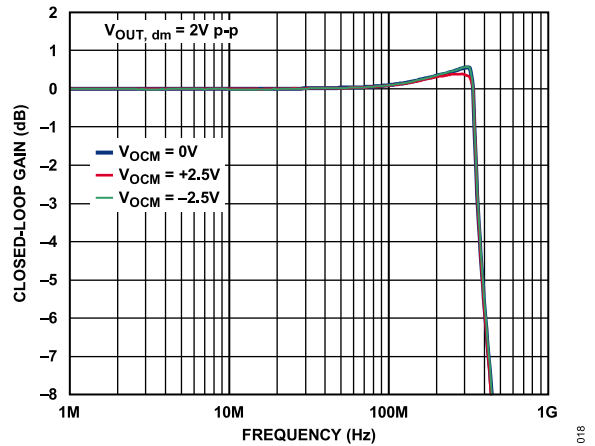

Figure 17. Large Signal Frequency Response for Various V_{OCM} Levels

TYPICAL PERFORMANCE CHARACTERISTICS

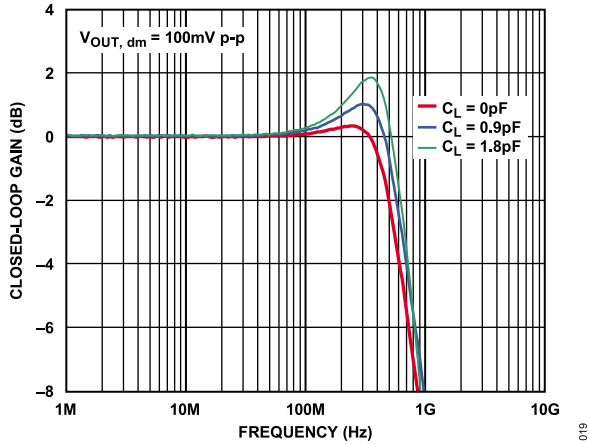

Figure 18. Small Signal Frequency Response at Various Capacitive Loads

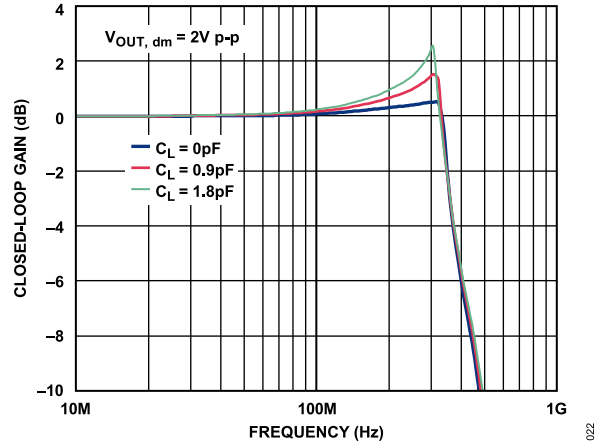

Figure 21. Large Signal Frequency Response at Various Capacitive Loads

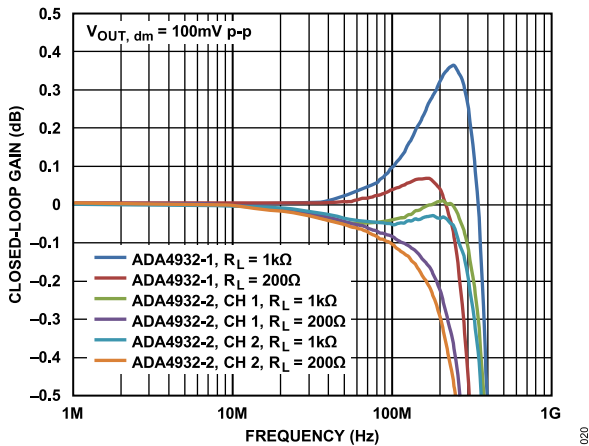

Figure 19. 0.1 dB Flatness Small Signal Frequency Response for Various Loads

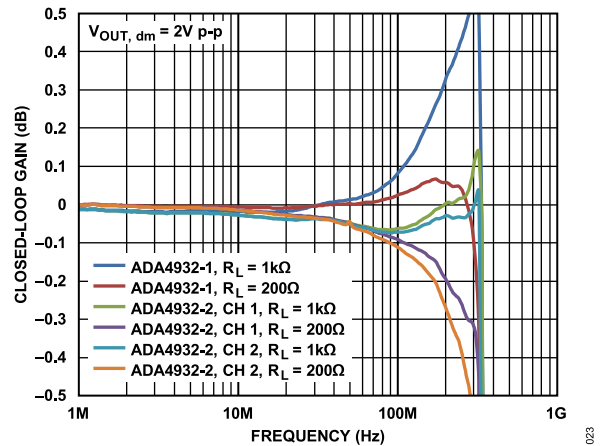

Figure 22. 0.1 dB Flatness Large Signal Frequency Response for Various Loads

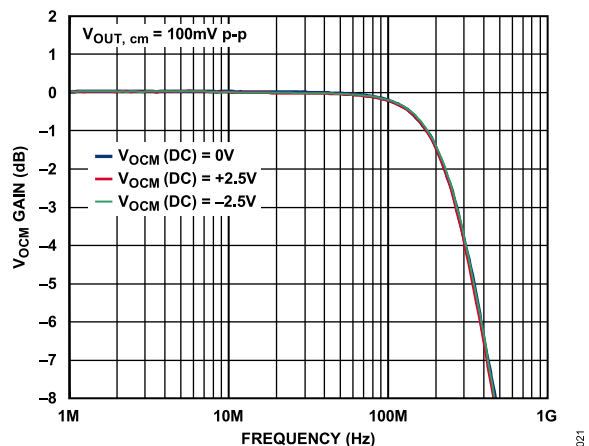

Figure 20. V_{OCM} Small Signal Frequency Response at Various DC Levels

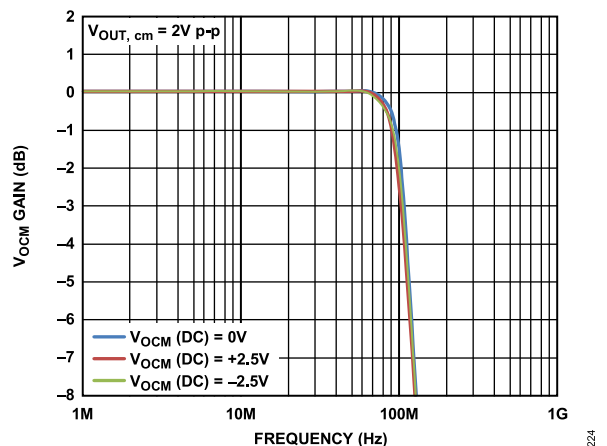

Figure 23. V_{OCM} Large Signal Frequency Response at Various DC Levels

TYPICAL PERFORMANCE CHARACTERISTICS

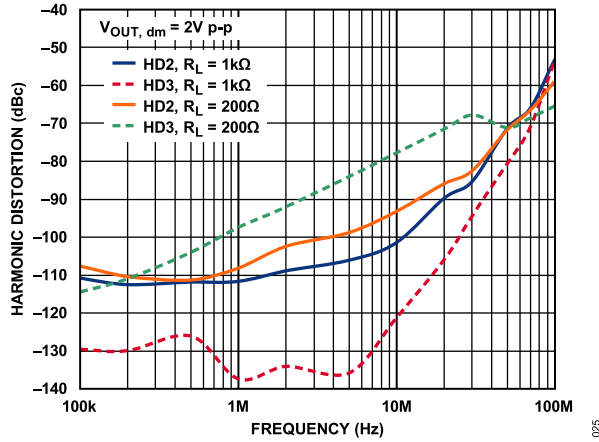

Figure 24. Harmonic Distortion vs. Frequency at Various Loads

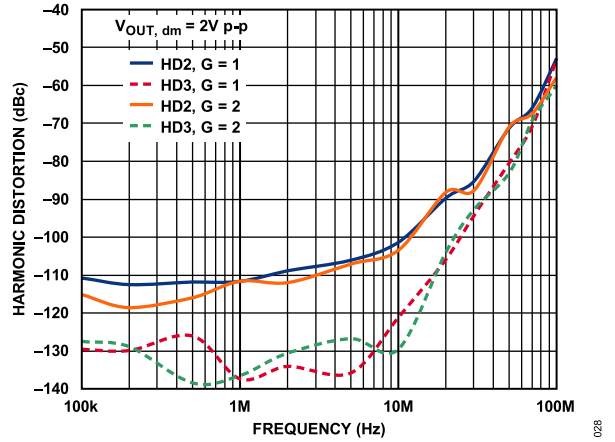

Figure 27. Harmonic Distortion vs. Frequency at Various Gains

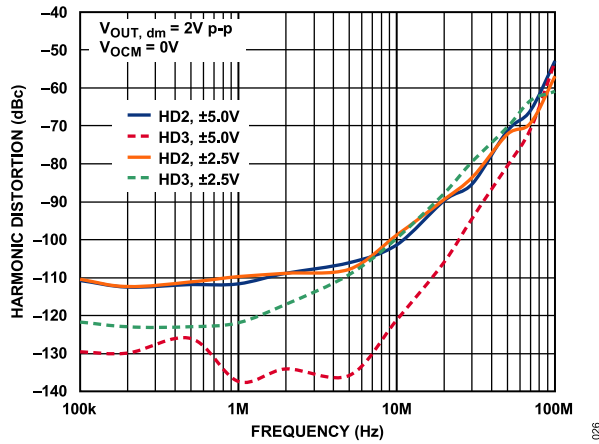

Figure 25. Harmonic Distortion vs. Frequency at Various Supplies

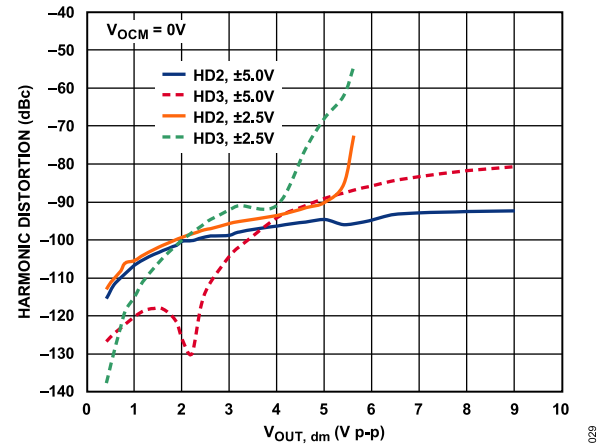

Figure 28. Harmonic Distortion vs. $V_{OUT, dm}$ and Supply Voltage, $f = 10\text{ MHz}$

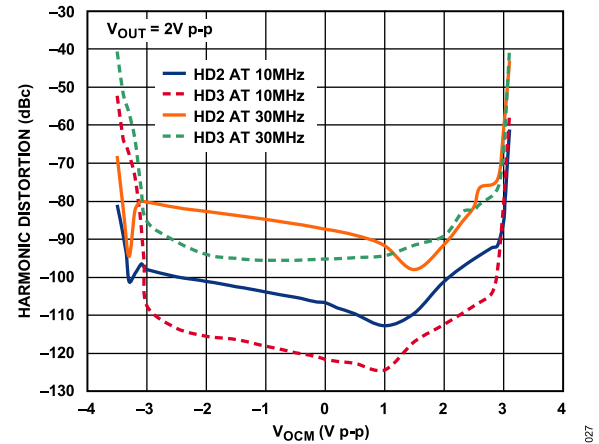

Figure 26. Harmonic Distortion vs. V_{OCM} at Various Frequencies, $\pm 5\text{ V}$ Supplies

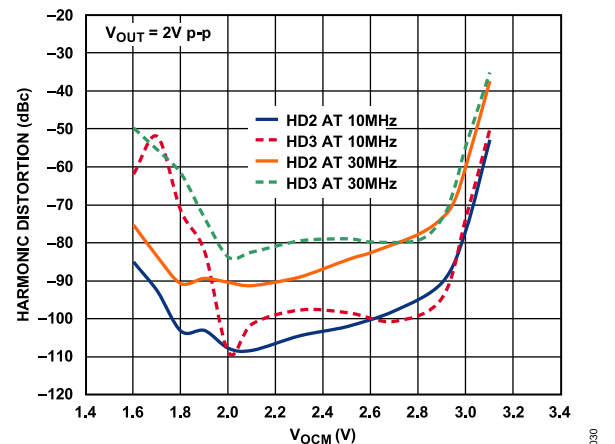

Figure 29. Harmonic Distortion vs. V_{OCM} at Various Frequencies, $+5\text{ V}$ Supply

TYPICAL PERFORMANCE CHARACTERISTICS

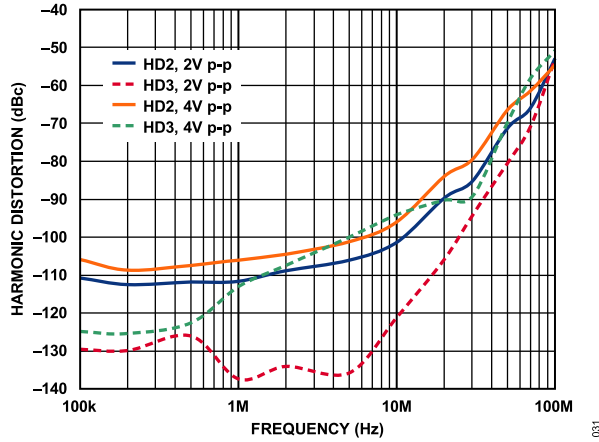

Figure 30. Harmonic Distortion vs. Frequency at Various $V_{OUT, dm}$

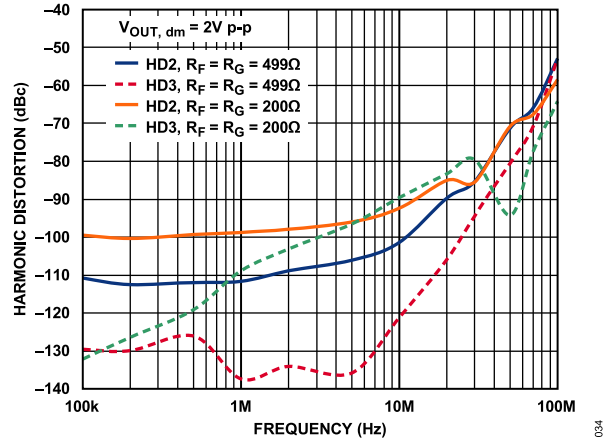

Figure 33. Harmonic Distortion vs. Frequency at Various R_F and R_G

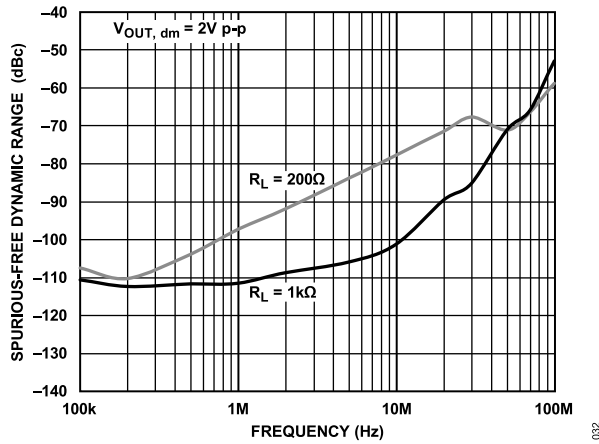

Figure 31. Spurious-Free Dynamic Range vs. Frequency at Various Loads

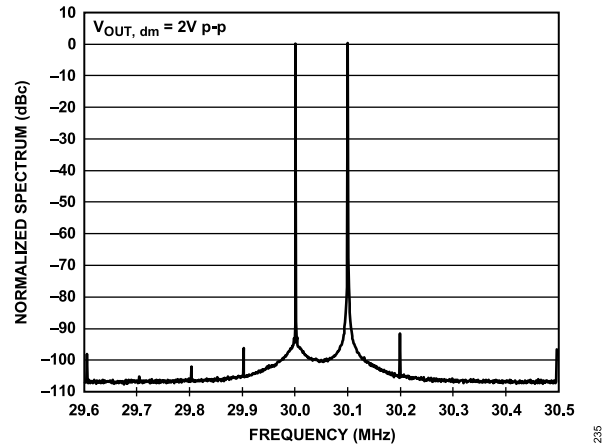

Figure 34. 30 MHz Intermodulation Distortion

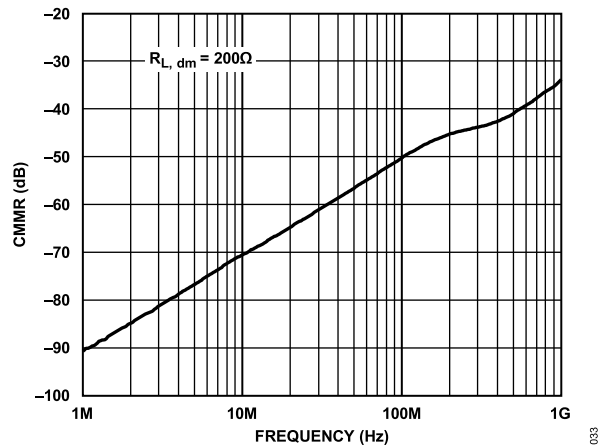

Figure 32. CMRR vs. Frequency

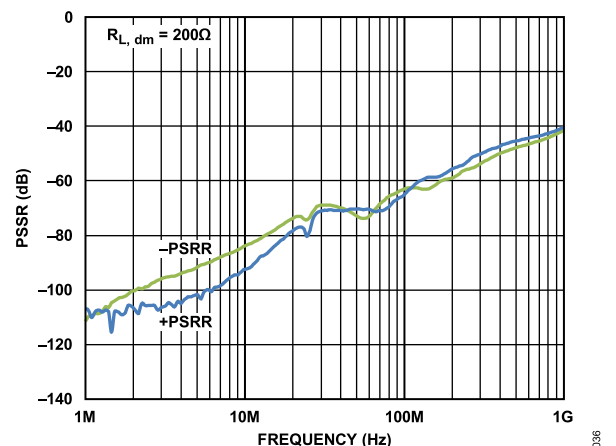

Figure 35. PSRR vs. Frequency

TYPICAL PERFORMANCE CHARACTERISTICS

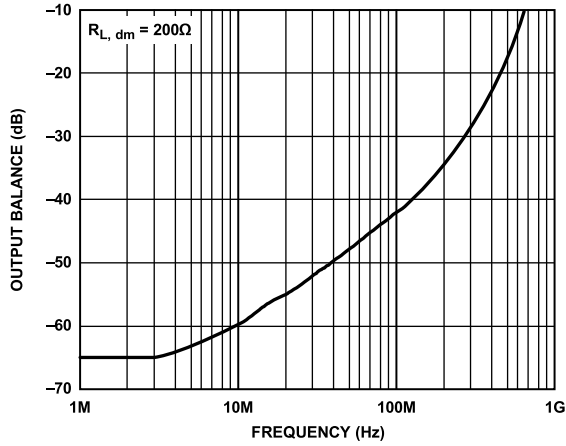

Figure 36. Output Balance vs. Frequency

237

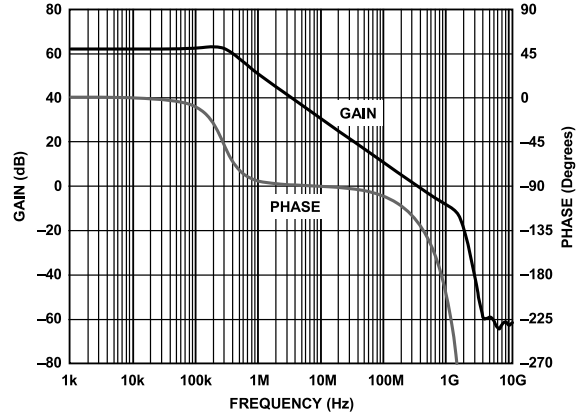

Figure 39. Open-Loop Gain and Phase vs. Frequency

240

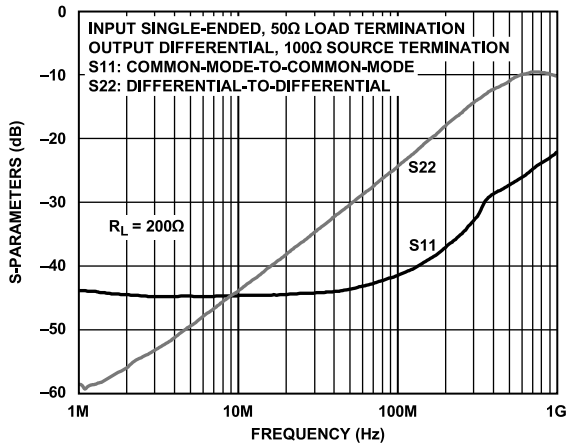

Figure 37. Return Loss (S_{11} , S_{22}) vs. Frequency

038

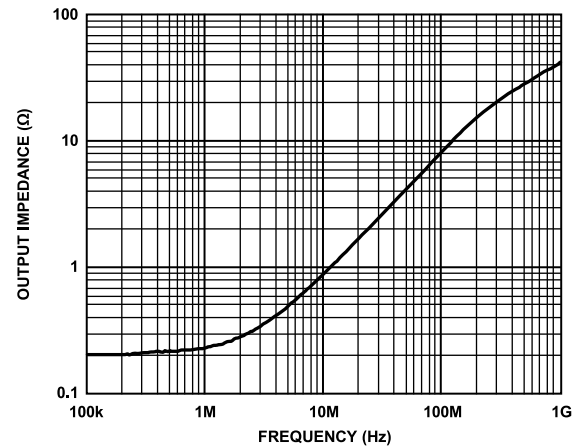

Figure 40. Closed-Loop Output Impedance Magnitude vs. Frequency, $G = 1$

241

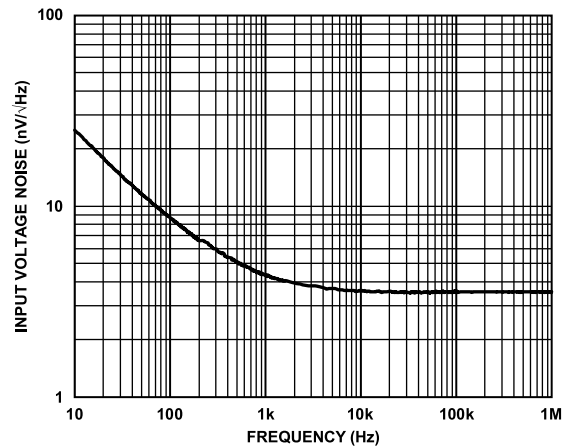

Figure 38. Voltage Noise Spectral Density, Referred to Input

039

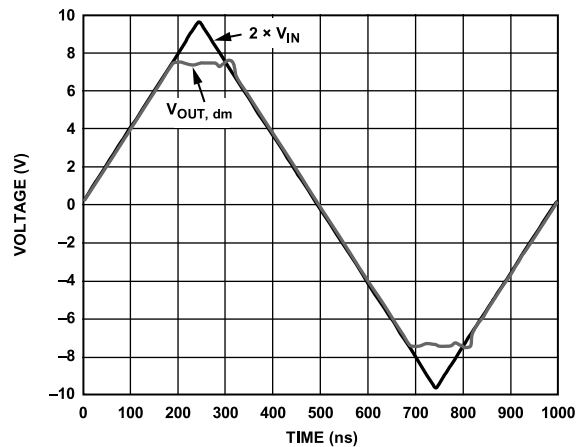

Figure 41. Overdrive Recovery, $G = 2$

242

TYPICAL PERFORMANCE CHARACTERISTICS

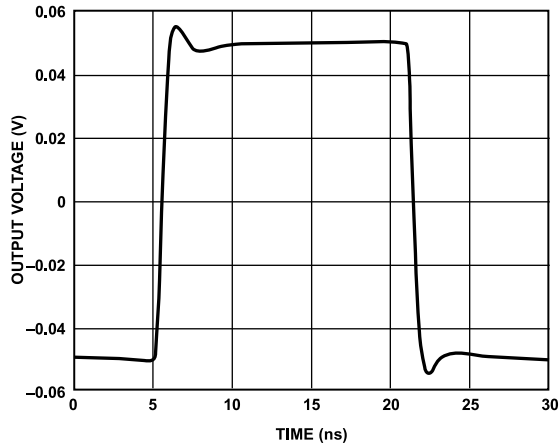

Figure 42. Small Signal Pulse Response

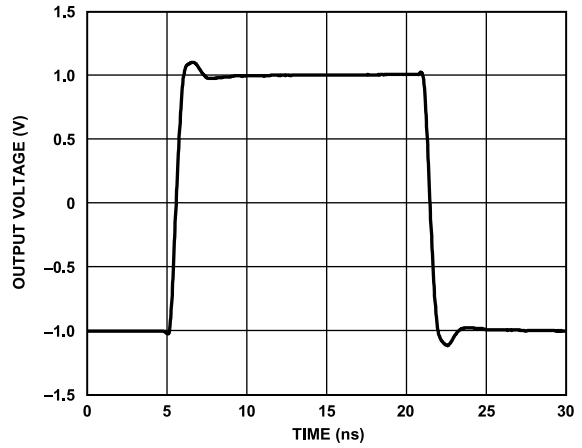

Figure 45. Large Signal Pulse Response

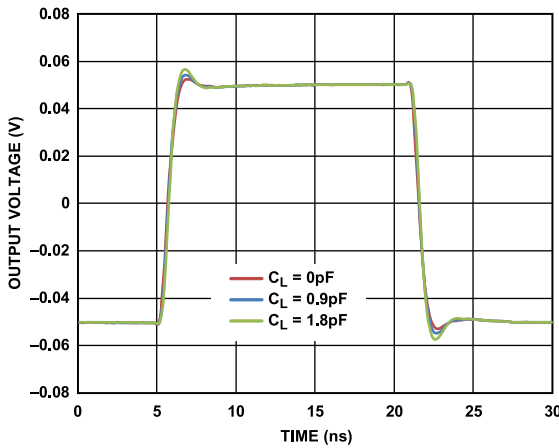

Figure 43. Small Signal Pulse Response for Various Capacitive Loads

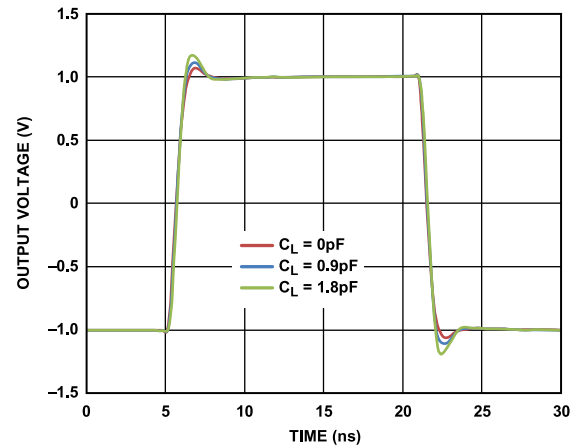

Figure 46. Large Signal Pulse Response for Various Capacitive Loads

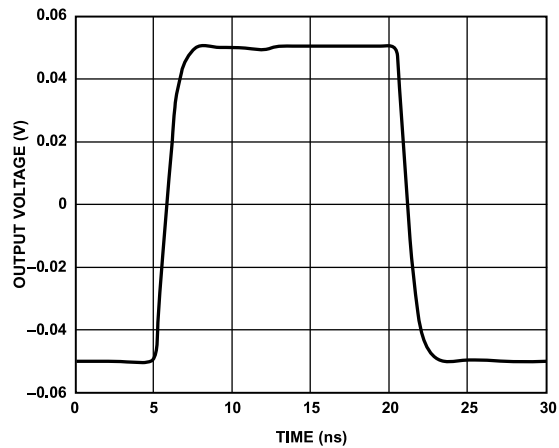

Figure 44. V_{OCM} Small Signal Pulse Response

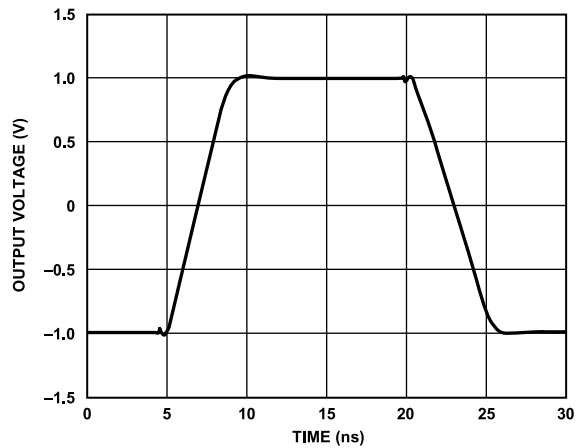

Figure 47. V_{OCM} Large Signal Pulse Response

TYPICAL PERFORMANCE CHARACTERISTICS

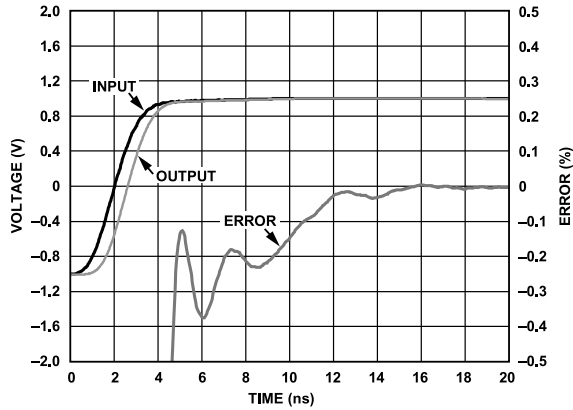

Figure 48. Settling Time

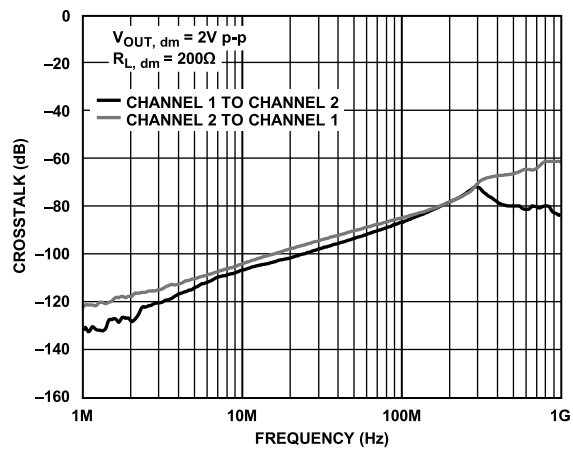

Figure 49. Crosstalk vs. Frequency, ADA4932-2

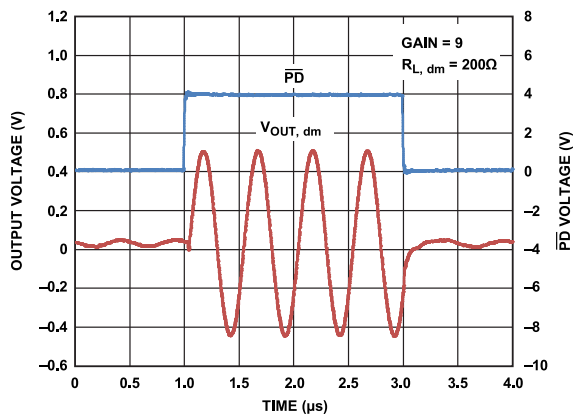

Figure 50. \overline{PD} Response Time

TEST CIRCUITS

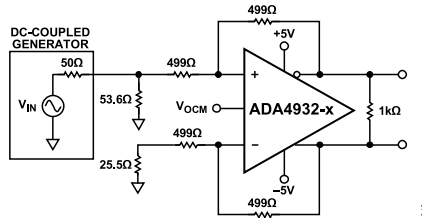

Figure 51. Equivalent Basic Test Circuit, $G = 1$

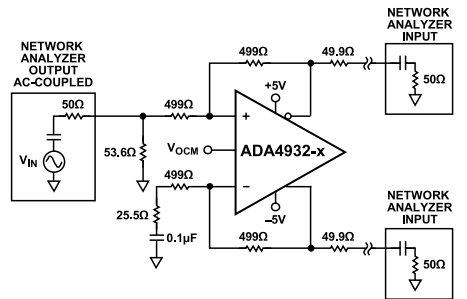

Figure 52. Test Circuit for Output Balance, CMRR

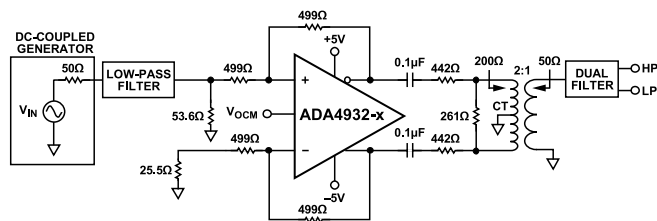

Figure 53. Test Circuit for Distortion Measurements

TERMINOLOGY

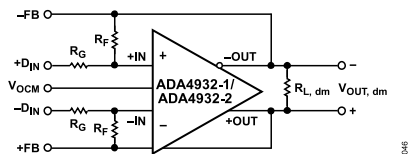

Figure 54. Signal and Circuit Definitions

Differential Voltage

Differential voltage refers to the difference between two node voltages. For example, the output differential voltage (or equivalently, output differential mode voltage) is defined as

$$V_{OUT, dm} = (V_{+OUT} - V_{-OUT})$$

where V_{+OUT} and V_{-OUT} refer to the voltages at the +OUT and -OUT terminals with respect to a common ground reference. Similarly, the differential input voltage is defined as

$$V_{IN, dm} = (+D_{IN} - (-D_{IN}))$$

Common-Mode Voltage

Common-mode voltage refers to the average of two node voltages with respect to the local ground reference. The output common-mode voltage is defined as

$$V_{OUT, cm} = (V_{+OUT} + V_{-OUT})/2$$

Balance

Output balance is a measure of how close the output differential signals are to being equal in amplitude and opposite in phase. Output balance is most easily determined by placing a well-matched resistor divider between the differential voltage nodes and comparing the magnitude of the signal at the divider midpoint with the magnitude of the differential signal (see Figure 52). By this definition, output balance is the magnitude of the output common-mode voltage divided by the magnitude of the output differential mode voltage.

$$\text{Output Balance Error} = \left| \frac{\Delta V_{OUT, cm}}{\Delta V_{OUT, dm}} \right|$$

THEORY OF OPERATION

The ADA4932-1/ADA4932-2 differ from conventional op amps in that it has two outputs whose voltages move in opposite directions and an additional input, V_{OCM} . Like an op amp, it relies on high open-loop gain and negative feedback to force these outputs to the desired voltages. The ADA4932-1/ADA4932-2 behave much like standard voltage feedback op amps and facilitates single-ended-to-differential conversions, common-mode level shifting, and amplifications of differential signals. Like an op amp, the ADA4932-1/ADA4932-2 have high input impedance and low output impedance. Because they use voltage feedback, the ADA4932-1/ADA4932-2 manifest a nominally constant gain bandwidth product.

Two feedback loops are employed to control the differential and common-mode output voltages. The differential feedback, set with

external resistors, controls only the differential output voltage. The common-mode feedback controls only the common-mode output voltage. This architecture makes it easy to set the output common-mode level to any arbitrary value within the specified limits. The output common-mode voltage is forced, by the internal common-mode feedback loop, to be equal to the voltage applied to the V_{OCM} input.

The internal common-mode feedback loop produces outputs that are highly balanced over a wide frequency range without requiring tightly matched external components. This results in differential outputs that are very close to the ideal of being identical in amplitude and are exactly 180° apart in phase.

APPLICATIONS INFORMATION

ANALYZING AN APPLICATION CIRCUIT

The ADA4932-1/ADA4932-2 use high open-loop gain and negative feedback to force their differential and common-mode output voltages in such a way as to minimize the differential and common-mode error voltages. The differential error voltage is defined as the voltage between the differential inputs labeled +IN and -IN (see Figure 54). For most purposes, this voltage is zero. Similarly, the difference between the actual output common-mode voltage and the voltage applied to V_{OCM} is also zero. Starting from these principles, any application circuit can be analyzed.

SETTING THE CLOSED-LOOP GAIN

Using the approach described in the Analyzing an Application Circuit section, the differential gain of the circuit in Figure 54 can be determined by

$$\left| \frac{V_{OUT, dm}}{V_{IN, dm}} \right| = \frac{R_F}{R_G}$$

This presumes that the input resistors (R_G) and feedback resistors (R_F) on each side are equal.

ESTIMATING THE OUTPUT NOISE VOLTAGE

The differential output noise of the ADA4932-1/ADA4932-2 can be estimated using the noise model in Figure 55. The input-referred

noise voltage density, v_{nIN}, is modeled as a differential input, and the noise currents, i_{nIN-} and i_{nIN+}, appear between each input and ground. The output voltage due to v_{nIN} is obtained by multiplying v_{nIN} by the noise gain, G_N (defined in the G_N equation that follows). The noise currents are uncorrelated with the same mean-square value, and each produces an output voltage that is equal to the noise current multiplied by the associated feedback resistance. The noise voltage density at the V_{OCM}/V_{OCMx} pin is v_{nCM}. When the feedback networks have the same feedback factor, as is true in most cases, the output noise due to v_{nCM} is common mode. Each of the four resistors contributes (4kTR_{xx})^{1/2}. The noise from the feedback resistors appears directly at the output, and the noise from the gain resistors appears at the output multiplied by R_F/R_G. Table 11 summarizes the input noise sources, the multiplication factors, and the output-referred noise density terms.

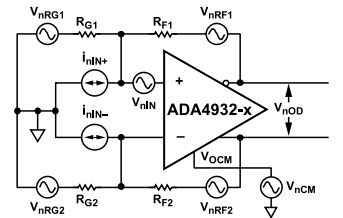

Figure 55. Noise Model

Table 11. Output Noise Voltage Density Calculations for Matched Feedback Networks

Input Noise Contribution	Input Noise Term	Input Noise Voltage Density	Output Multiplication Factor	Differential Output Noise Voltage Density Term
Differential Input	v _{nIN}	v _{nIN}	G _N	v _{nO1} = G _N (v _{nIN})
Inverting Input	i _{nIN-}	i _{nIN-} × (R _{F2})	1	v _{nO2} = (i _{nIN-})(R _{F2})
Noninverting Input	i _{nIN+}	i _{nIN+} × (R _{F1})	1	v _{nO3} = (i _{nIN+})(R _{F1})
V _{OCM} Input	v _{nCM}	v _{nCM}	0	v _{nO4} = 0 V
Gain Resistor, R _{G1}	v _{nRG1}	(4kTR _{G1}) ^{1/2}	R _{F1} /R _{G1}	v _{nO5} = (R _{F1} /R _{G1})(4kTR _{G1}) ^{1/2}
Gain Resistor, R _{G2}	v _{nRG2}	(4kTR _{G2}) ^{1/2}	R _{F2} /R _{G2}	v _{nO6} = (R _{F2} /R _{G2})(4kTR _{G2}) ^{1/2}
Feedback Resistor, R _{F1}	v _{nRF1}	(4kTR _{F1}) ^{1/2}	1	v _{nO7} = (4kTR _{F1}) ^{1/2}
Feedback Resistor, R _{F2}	v _{nRF2}	(4kTR _{F2}) ^{1/2}	1	v _{nO8} = (4kTR _{F2}) ^{1/2}

Table 12. Differential Input, DC-Coupled

Nominal Gain (dB)	R _F (Ω)	R _G (Ω)	R _{IN, dm} (Ω)	Differential Output Noise Density (nV/√Hz)
0	499	499	998	9.25
6	499	249	498	12.9
10	768	243	486	18.2

Table 13. Single-Ended Ground-Referenced Input, DC-Coupled, R_S = 50 Ω

Nominal Gain (dB)	R _F (Ω)	R _{G1} (Ω)	R _T (Ω) (Std 1%)	R _{IN, cm} (Ω)	R _{G2} (Ω) ¹	Differential Output Noise Density (nV/√Hz)
0	511	499	53.6	665	525	9.19
6	523	249	57.6	374	276	12.6
10	806	243	57.6	392	270	17.7

¹ R_{G2} = R_{G1} + (R_S||R_T).

APPLICATIONS INFORMATION

Similar to the case of a conventional op amp, the output noise voltage densities can be estimated by multiplying the input-referred terms at +IN and -IN by the appropriate output factor,

where:

$G_N = \frac{2}{(\beta_1 + \beta_2)}$ is the circuit noise gain.

$\beta_1 = \frac{R_{G1}}{R_{F1} + R_{G1}}$ and $\beta_2 = \frac{R_{G2}}{R_{F2} + R_{G2}}$ are the feedback factors.

When the feedback factors are matched, $R_{F1}/R_{G1} = R_{F2}/R_{G2}$, $\beta_1 = \beta_2 = \beta$, and the noise gain becomes

$$G_N = \frac{1}{\beta} = 1 + \frac{R_F}{R_G}$$

Note that the output noise from V_{OCM} goes to zero in this case. The total differential output noise density, v_{nOD} , is the root-sum-square of the individual output noise terms.

$$v_{nOD} = \sqrt{\sum_{i=1}^8 v_{nOi}^2}$$

Table 12 and Table 13 list several common gain settings, associated resistor values, input impedance, and output noise density for both balanced and unbalanced input configurations.

IMPACT OF MISMATCHES IN THE FEEDBACK NETWORKS

As previously mentioned, even if the external feedback networks (R_F/R_G) are mismatched, the internal common-mode feedback loop still forces the outputs to remain balanced. The amplitudes of the signals at each output remain equal and 180° out of phase. The input-to-output differential mode gain varies proportionately to the feedback mismatch, but the output balance is unaffected.

The gain from the V_{OCM}/V_{OCMx} pin to $V_{OUT, dm}$ is equal to

$$2(\beta_1 - \beta_2)/(\beta_1 + \beta_2)$$

When $\beta_1 = \beta_2$, this term goes to zero and there is no differential output voltage due to the voltage on the V_{OCM} input (including noise). The extreme case occurs when one loop is open and the other has 100% feedback; in this case, the gain from V_{OCM} input to $V_{OUT, dm}$ is either +2 or -2, depending on which loop is closed. The feedback loops are nominally matched to within 1% in most applications, and the output noise and offsets due to the V_{OCM} input are negligible. If the loops are intentionally mismatched by a large amount, it is necessary to include the gain term from V_{OCM} to $V_{OUT, dm}$ and account for the extra noise. For example, if $\beta_1 = 0.5$ and $\beta_2 = 0.25$, the gain from V_{OCM} to $V_{OUT, dm}$ is 0.67. If the V_{OCM}/V_{OCMx} pin is set to 2.5 V, a differential offset voltage is present at the output of $(2.5 \text{ V})(0.67) = 1.67 \text{ V}$. The differential output noise contribution is $(9.6 \text{ nV}/\sqrt{\text{Hz}})(0.67) = 6.4 \text{ nV}/\sqrt{\text{Hz}}$. Both of these results are undesirable in most applications; therefore, it is best to use nominally matched feedback factors.

Mismatched feedback networks also result in a degradation of the ability of the circuit to reject input common-mode signals, much the same as for a four-resistor difference amplifier made from a conventional op amp.

As a practical summarization of the above issues, resistors of 1% tolerance produce a worst-case input CMRR of approximately 40 dB, a worst-case differential-mode output offset of 25 mV due to a 2.5 V V_{OCM} input, negligible V_{OCM} noise contribution, and no significant degradation in output balance error.

CALCULATING THE INPUT IMPEDANCE FOR AN APPLICATION CIRCUIT

The effective input impedance of a circuit depends on whether the amplifier is being driven by a single-ended or differential signal source. For balanced differential input signals, as shown in Figure 56, the input impedance ($R_{IN, dm}$) between the inputs (+D_{IN} and -D_{IN}) is $R_{IN, dm} = R_G + R_G = 2 \times R_G$.

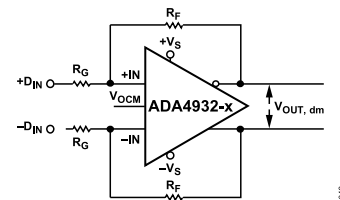

Figure 56. ADA4932-1/ADA4932-2 Configured for Balanced (Differential) Inputs

For an unbalanced, single-ended input signal (see Figure 57), the input impedance is

$$R_{IN, se} = \left(\frac{R_G}{1 - \frac{R_F}{2 \times (R_G + R_F)}} \right)$$

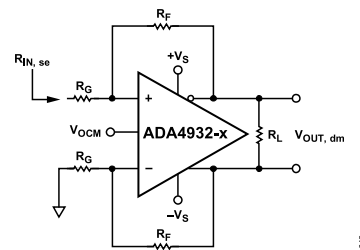

Figure 57. The ADA4932-1/ADA4932-2 with Unbalanced (Single-Ended) Input

The input impedance of the circuit is effectively higher than it is for a conventional op amp connected as an inverter because a fraction of the differential output voltage appears at the inputs as a common-mode signal, partially bootstrapping the voltage across the input resistor, R_G . The common-mode voltage at the amplifier input terminals can be easily determined by noting that the voltage at the inverting input is equal to the noninverting output voltage divided down by the voltage divider that is formed by R_F and R_G in the lower loop. This voltage is present at both input terminals due

APPLICATIONS INFORMATION

to negative voltage feedback and is in phase with the input signal, thus reducing the effective voltage across R_G in the upper loop and partially bootstrapping R_G .

Terminating a Single-Ended Input

This section describes how to properly terminate a single-ended input to the ADA4932-1/ADA4932-2 with a gain of 1, $R_F = 499 \Omega$, and $R_G = 499 \Omega$. An example using an input source with a terminated output voltage of 1 V p-p and source resistance of 50 Ω illustrates the four steps that must be followed. Note that because the terminated output voltage of the source is 1 V p-p, the open-circuit output voltage of the source is 2 V p-p. The source shown in Figure 58 indicates this open-circuit voltage.

1. Calculate the input impedance by using the following formula:

$$R_{IN, se} = \left(\frac{R_G}{1 - \frac{R_G}{2 \times (R_G + R_F)}} \right) = \left(\frac{499}{1 - \frac{499}{2 \times (499 + 499)}} \right)$$

$$= 665 \Omega$$

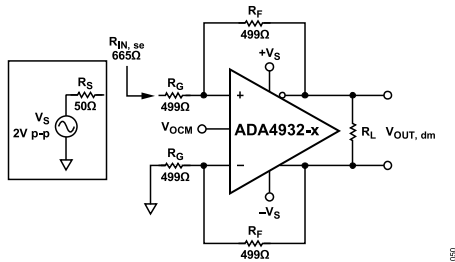

Figure 58. Calculating Single-Ended Input Impedance, R_{IN}

2. To match the 50 Ω source resistance, calculate the termination resistor, R_T , using $R_T || 665 \Omega = 50 \Omega$. The closest standard 1% value for R_T is 53.6 Ω .

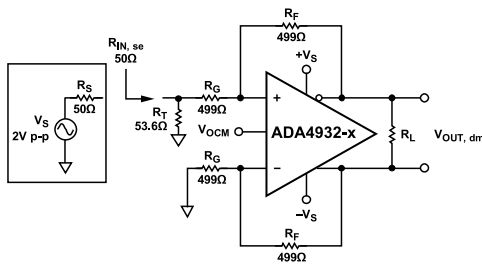

Figure 59. Adding Termination Resistor, R_T

3. Figure 59 shows that the effective R_G in the upper feedback loop is now greater than the R_G in the lower loop due to the addition of the termination resistors. To compensate for the imbalance of the gain resistors, add a correction resistor (R_{TS}) in series with R_G in the lower loop. R_{TS} is the Thevenin equivalent of the source resistance, R_S , and the termination resistance, R_T , and is equal to $R_S || R_T$.

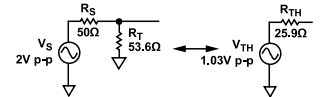

Figure 60. Calculating the Thevenin Equivalent

$R_{TS} = R_{TH} = R_S || R_T = 25.9 \Omega$. Note that V_{TH} is greater than 1 V p-p, which was obtained with $R_T = 50 \Omega$. The modified circuit with the Thevenin equivalent (closest 1% value used for R_{TH}) of the terminated source and R_{TS} in the lower feedback loop is shown in Figure 61.

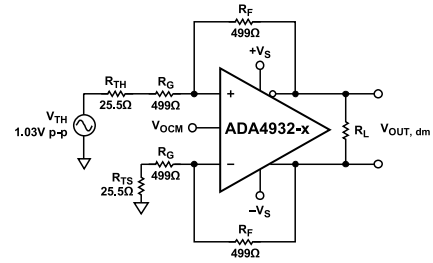

Figure 61. Thevenin Equivalent and Matched Gain Resistors

Figure 61 presents a tractable circuit with matched feedback loops that can be easily evaluated.

It is useful to point out two effects that occur with a terminated input. The first is that the value of R_G is increased in both loops, lowering the overall closed-loop gain. The second is that V_{TH} is a little larger than 1 V p-p, as it would be if $R_T = 50 \Omega$.

These two effects have opposite impacts on the output voltage, and for large resistor values in the feedback loops (~1 k Ω), the effects essentially cancel each other out. For small R_F and R_G , or high gains, however, the diminished closed-loop gain is not canceled completely by the increased V_{TH} . This can be seen by evaluating Figure 61.

The desired differential output in this example is 1 V p-p because the terminated input signal was 1 V p-p and the closed-loop gain = 1. The actual differential output voltage, however, is equal to $(1.03 \text{ V p-p})(499/524.5) = 0.98 \text{ V p-p}$. To obtain the desired output voltage of 1 V p-p, a final gain adjustment can be made by increasing R_F without modifying any of the input circuitry (see Step 4).

4. The feedback resistor value is modified as a final gain adjustment to obtain the desired output voltage.

To make the output voltage $V_{OUT} = 1 \text{ V p-p}$, calculate R_F by using the following formula:

$$R_F = \frac{(\text{Desired } V_{OUT, dm}) (R_G + R_{TS})}{V_{TH}} = \frac{(1 \text{ V p-p})(524.5)}{1.03 \text{ V p-p}} = 509 \Omega$$

The closest standard 1% value to 509 Ω is 511 Ω , which gives a differential output voltage of 1.00 V p-p.

APPLICATIONS INFORMATION

The final circuit is shown in [Figure 62](#).

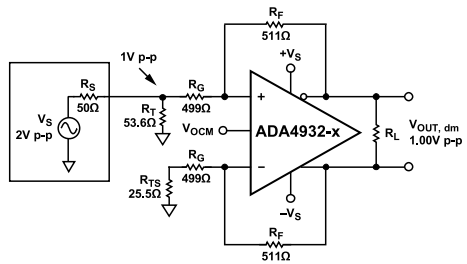

Figure 62. Terminated Single-Ended-to-Differential System with $G = 2$

INPUT COMMON-MODE VOLTAGE RANGE

The ADA4932-1/ADA4932-2 input common-mode range is shifted down by approximately one V_{BE} , in contrast to other ADC drivers with centered input ranges such as the ADA4932-1/ADA4932-2. The downward-shifted input common-mode range is especially suited to dc-coupled, single-ended-to-differential, and single-supply applications.

For ± 5 V operation, the input common-mode range at the summing nodes of the amplifier is specified as -4.8 V to $+3.2$ V, and is specified as $+0.2$ V to $+3.2$ V with a $+5$ V supply. To avoid nonlinearities, the voltage swing at the $+IN$ and $-IN$ terminals must be confined to these ranges.

INPUT AND OUTPUT CAPACITIVE AC COUPLING

While the ADA4932-1/ADA4932-2 is best suited to dc-coupled applications, it is nonetheless possible to use it in ac-coupled circuits. Input ac coupling capacitors can be inserted between the source and R_G . This ac coupling blocks the flow of the dc common-mode feedback current and causes the ADA4932-1/ADA4932-2 dc input common-mode voltage to equal the dc output common-mode voltage. These ac coupling capacitors must be placed in both loops to keep the feedback factors matched. Output ac coupling capacitors can be placed in series between each output and its respective load.

SETTING THE OUTPUT COMMON-MODE VOLTAGE

The V_{OCM}/V_{OCMx} pin of the ADA4932-1/ADA4932-2 is internally biased with a voltage divider comprised of two 50 k Ω resistors across the supplies, with a tap at a voltage approximately equal to the midsupply point, $[(+V_S) + (-V_S)]/2$. Because of this internal divider, the V_{OCM}/V_{OCMx} pin sources and sinks current, depending on the externally applied voltage and its associated source resistance. Relying on the internal bias results in an output common-mode voltage that is within about 100 mV of the expected value.

In cases where more accurate control of the output common-mode level is required, it is recommended that an external source or resistor divider be used with source resistance less than 100 Ω . If an external voltage divider consisting of equal resistor values

is used to set V_{OCM} to midsupply with greater accuracy than produced internally, higher values can be used because the external resistors are placed in parallel with the internal resistors. The output common-mode offset listed in the [Specifications](#) section assumes that the V_{OCM} input is driven by a low impedance voltage source.

It is also possible to connect the V_{OCM} input to a common-mode level (CML) output of an ADC; however, care must be taken to ensure that the output has sufficient drive capability. The input impedance of the V_{OCM}/V_{OCMx} pin is approximately 25 k Ω . If multiple ADA4932-1/ADA4932-2 devices share one ADC reference output, a buffer may be necessary to drive the parallel inputs.

HIGH PERFORMANCE PRECISION ADC DRIVER

Using a differential amplifier to drive an ADC successfully is linked to balancing each side of the differential amplifier correctly. [Figure 64](#) shows the schematic for the ADA4932-1, [AD7626](#), and associated circuitry. In the test circuit used, a 2.4 MHz band-pass filter follows the signal source. The band-pass filter eliminates harmonics of the 2.4 MHz signal and ensures that only the frequency of interest is passed and processed by the ADA4932-1 and [AD7626](#).

The ADA4932-1 is particularly useful when driving higher frequency inputs to the [AD7626](#), a 10 MSPS ADC with a switched capacitor input. The resistor (R_8 , R_9) and capacitor (C_5 , C_6) circuit between the ADA4932-1 and [AD7626](#) $IN+$ and $IN-$ pins acts as a low-pass filter to noise. The filter limits the input bandwidth to the [AD7626](#), but its main function is to optimize the interface between the driving amplifier and the [AD7626](#). The series resistor isolates the driver amplifier from high frequency switching spikes from the ADC switched capacitor front end. The [AD7626](#) data sheet shows values of 20 Ω and 56 pF. In [Figure 64](#), these values were empirically optimized to 33 Ω and 56 pF. The resistor-capacitor combination can be optimized slightly for the circuit and input frequency being converted by simply varying the R-C combination; however, keep in mind that having the incorrect combination limits the THD and linearity performance of the [AD7626](#). In addition, increasing the bandwidth as seen by the ADC introduces more noise. Another aspect of optimization is the selection of the power supply voltages for the ADA4932-1. In the circuit, the output common-mode voltage (V_{CM} pin) of the [AD7626](#) is 2.048 V for the internal reference voltage of 4.096 V, and each input ($IN+$, $IN-$) swings between 0 V and 4.096 V, 180° out of phase. This provides an 8.2 V full-scale differential input to the ADC. The ADA4932-1 output stage requires about 1.4 V headroom with respect to each supply voltage for linear operation. Optimum distortion performance is obtained when the supply voltages are approximately symmetrical about the common-mode voltage. If a negative supply of -2.5 V is chosen, then a positive supply of at least $+6.5$ V is needed for symmetry about the common-mode voltage of 2.048 V.

Experiments performed indicate that a positive supply of 7.25 V gives the best overall distortion for a 2.4 MHz tone. Using a low jitter clock source and a single tone -1 dBFS amplitude, 2.402 MHz

APPLICATIONS INFORMATION

input to the AD7626 yielded the results shown in Figure 63 of 88.49 dB SNR and -86.17 dB THD. At this input level, the ADC limits the SFDR to 83.8 dB. As can be seen from the plot, the harmonics of the fundamental alias back into the pass band. For example, when sampling at 10 MSPS, the third harmonic (7.206 MHz) is aliased into the pass band at 10.000 MHz - 7.206 MHz = 2.794 MHz.

The nonharmonic noise admitted through the pass band of the band-pass filter used in the circuit is replaced by the average noise across the Nyquist bandwidth when calculating the SNR and THD. The performance of this or any high speed circuit is highly dependent on proper PCB layout. This includes, but is not limited to, power supply bypassing, controlled impedance lines (where required), component placement, signal routing, and power and ground planes. For a more detailed analysis of this circuit, refer to Circuit Note CN-0105.

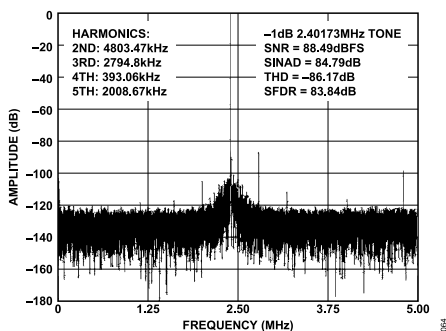

Figure 63. AD7626 Output, 64,000 Point, FFT Plot -1 dBFS Amplitude 2.40173 MHz Input Ton, 10.000 MSPS Sampling Rate

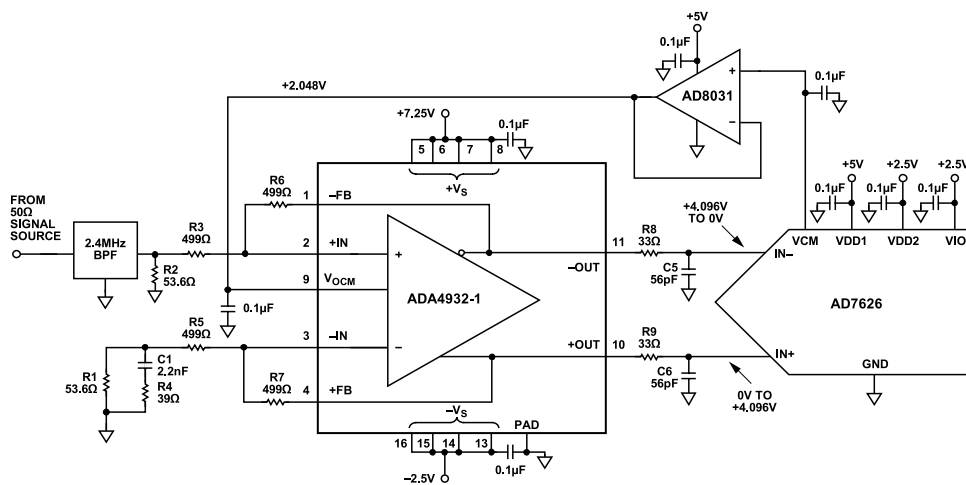

Figure 64. ADA4932-1 Driving the AD7626 (All Connections and Decoupling Not Shown)

HIGH PERFORMANCE ADC DRIVING

The ADA4932-1/ADA4932-2 are ideally suited for broadband dc-coupled applications. The circuit in Figure 65 shows a front-end connection for an ADA4932-1 driving an AD9245, a 14-bit, 20 MSPS/40 MSPS/65 MSPS/80 MSPS ADC, with dc coupling on the ADA4932-1 input and output. (The AD9245 achieves its optimum performance when driven differentially.) The ADA4932-1 eliminates the need for a transformer to drive the ADC and performs a single-ended-to-differential conversion and buffering of the driving signal.

The ADA4932-1 is configured with a single 3.3 V supply and a gain of 1 for a single-ended input to differential output. The 53.6 Ω termination resistor, in parallel with the single-ended input impedance of approximately 665 Ω, provides a 50 Ω termination for the source. The additional 25.5 Ω (524.5 Ω total) at the inverting input balances the parallel impedance of the 50 Ω source and the termination resistor driving the noninverting input.

In this example, the signal generator has a 1 V p-p symmetric, ground-referenced bipolar output when terminated in 50 Ω. The V_{OCM} input is bypassed for noise reduction, and set externally with 1% resistors to maximize output dynamic range on the tight 3.3 V supply.

Because the inputs are dc-coupled, dc common-mode current flows in the feedback loops, and a nominal dc level of 0.84 V is present at the amplifier input terminals. A fraction of the output signal is also present at the input terminals as a common-mode signal; its level is equal to the ac output swing at the noninverting output, divided down by the feedback factor of the lower loop. In this example, this ripple is $0.5 \text{ V p-p} \times [524.5/(524.5 + 511)] = 0.25 \text{ V p-p}$. This ac signal is riding on the 0.84 V dc level, producing a voltage swing between 0.72 V and 0.97 V at the input terminals. This is well within the specified limits of 0.2 V to 1.5 V.

With an output common-mode voltage of 1.65 V, each ADA4932-1 output swings between 1.4 V and 1.9 V, opposite in phase, providing a gain of 1 and a 1 V p-p differential signal to the ADC input. The differential RC section between the ADA4932-1 output and the ADC provides single-pole low-pass filtering and extra buffering for the current spikes that are output from the ADC input when its SHA capacitors are discharged.

The AD9245 is configured for a 1 V p-p full-scale input by connecting its SENSE pin to VREF, as shown in Figure 65.

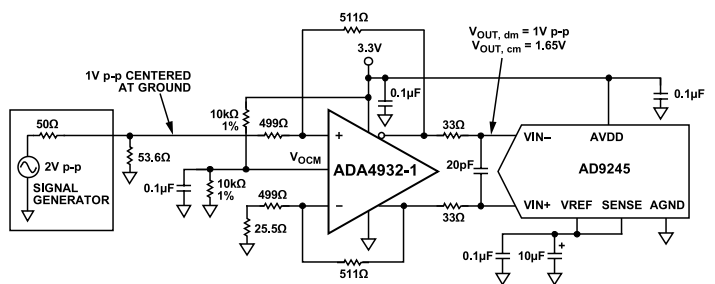

Figure 65. ADA4932-1 Driving an AD9245 ADC with DC-Coupled Input and Output

LAYOUT, GROUNDING, AND BYPASSING

As a high speed device, the ADA4932-1/ADA4932-2 are sensitive to the PCB environment in which it operates. Realizing its superior performance requires attention to the details of high speed PCB design.

The first requirement is a solid ground plane that covers as much of the board area around the ADA4932-1/ADA4932-2 as possible. However, the area near the feedback resistors (R_F), gain resistors (R_G), and clear the input summing nodes (Pin 2 and Pin 3) of all ground and power planes (see Figure 66). Clearing the ground and power planes minimizes any stray capacitance at these nodes and thus minimizes peaking of the response of the amplifier at high frequencies.

The thermal resistance, θ_{JA} , is specified for the device, including the exposed pad, soldered to a high thermal conductivity 4-layer circuit board, as described in EIA/JESD51-7.

Bypass the power supply pins as close to the device as possible and directly to a nearby ground plane. Use high frequency ceramic chip capacitors (1000 pF and 0.1 μ F) for each supply. Place the 1000 pF capacitor closer to the device. Further away, provide low frequency bulk bypassing using 10 μ F tantalum capacitors from each supply to ground.

Ensure that signal routing is short and direct to avoid parasitic effects. Wherever complementary signals exist, provide a symmetrical layout to maximize balanced performance. When routing differential signals over a long distance, keep PCB traces close together, and twist any differential wiring to minimize loop area. Doing this reduces radiated energy and makes the circuit less susceptible to interference.

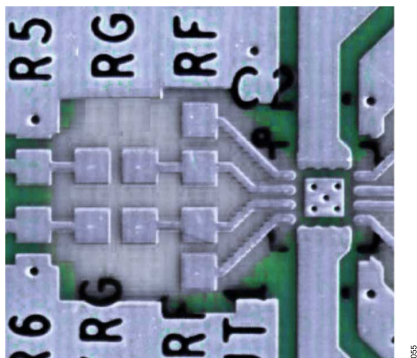

Figure 66. Ground and Power Plane Voiding in Vicinity of R_F and R_G

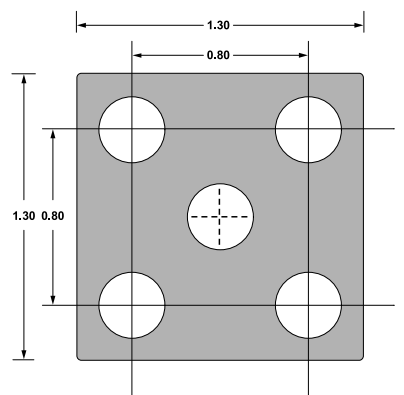

Figure 67. Recommended PCB Thermal Attach Pad Dimensions (Millimeters)

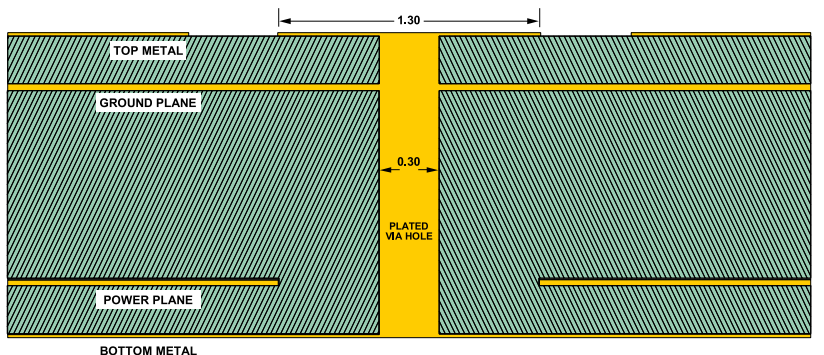
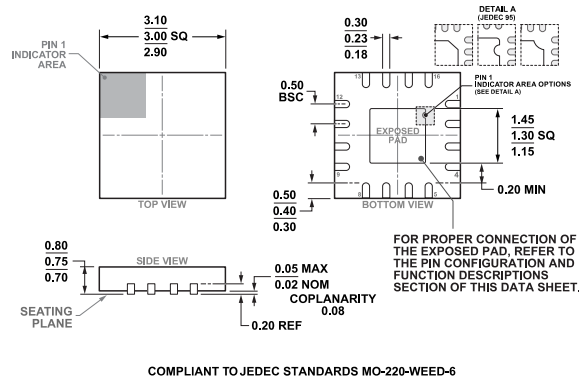
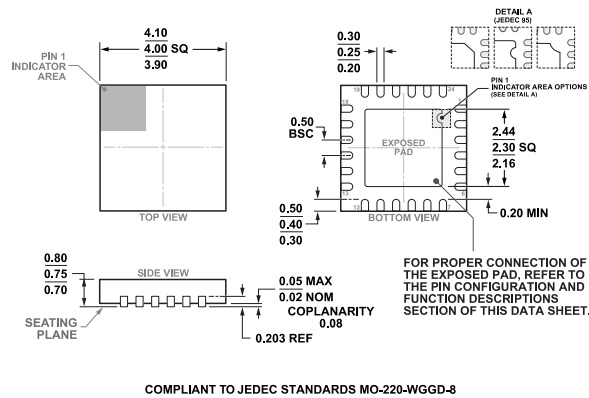

Figure 68. Cross-Section of 4-Layer PCB Showing Thermal Via Connection to Buried Ground Plane (Dimensions in Millimeters)

OUTLINE DIMENSIONS



**Figure 69. 16-Lead Lead Frame Chip Scale Package [LFCSP]
3 mm x 3 mm Body and 0.75 mm Package Height
(CP-16-21)
Dimensions shown in millimeters**



**Figure 70. 24-Lead Lead Frame Chip Scale Package [LFCSP]
4 mm x 4 mm Body and 0.75 mm Package Height
(CP-24-14)
Dimensions shown in millimeters**

Updated: April 04, 2022

ORDERING GUIDE

Model ¹	Temperature Range	Package Description	Packing Quantity	Package Option	Marking Code
ADA4932-1YCPZ-R2	-40°C to +105°C	16-Lead LFCSP (3mm x 3mm w/ EP)	Reel, 250	CP-16-21	H1K
ADA4932-1YCPZ-R7	-40°C to +105°C	16-Lead LFCSP (3mm x 3mm w/ EP)	Reel, 1500	CP-16-21	H1K
ADA4932-1YCPZ-RL	-40°C to +105°C	16-Lead LFCSP (3mm x 3mm w/ EP)	Reel, 5000	CP-16-21	H1K
ADA4932-2YCPZ-R2	-40°C to +105°C	24-Lead LFCSP (4mm x 5mm w/ EP)	Reel, 250	CP-24-14	
ADA4932-2YCPZ-R7	-40°C to +105°C	24-Lead LFCSP (4mm x 5mm w/ EP)	Reel, 1500	CP-24-14	
ADA4932-2YCPZ-RL	-40°C to +105°C	24-Lead LFCSP (4mm x 5mm w/ EP)	Reel, 5000	CP-24-14	

¹ Z = RoHS Compliant Part.