

HIGH FREQUENCY SECONDARY RECTIFIER

MAJOR PRODUCT CHARACTERISTICS

$I_{F(AV)}$	2 x 15 A
V_{RRM}	300 V
I_{RM} (typ.)	4.5A
T_j (max)	175 °C
V_F (max)	1.4 V
t_{rr} (max)	35 ns

FEATURES AND BENEFITS

- Designed for high frequency applications.
- Hyperfast recovery competes with GaAs devices.
- Allows size decrease of snubbers and heatsinks.

DESCRIPTION

The TURBOSWITCH "R" is an ultra high performance diode.

This TURBOSWITCH family, which drastically cuts losses in associated MOSFET when run at high dI_F/dt , is suited for HF OFF-Line SMPS and DC/DC converters.

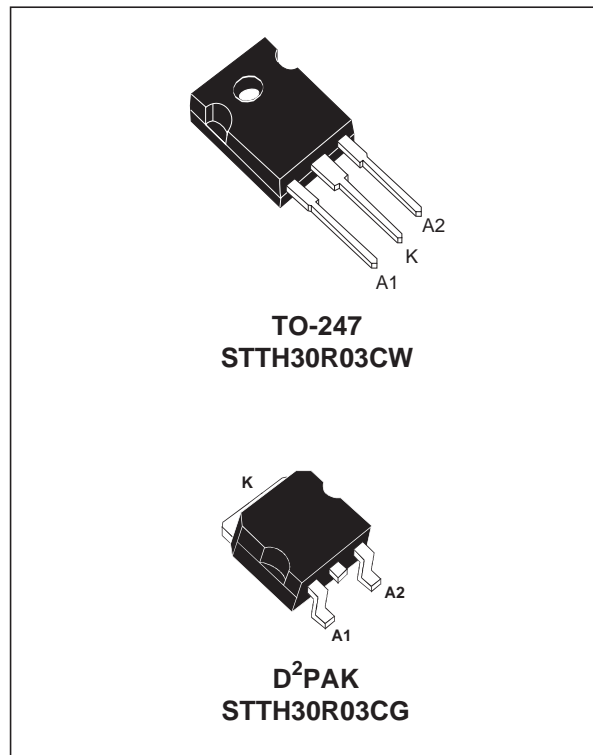

ABSOLUTE RATINGS (limiting values, per diode)

Symbol	Parameter		Value	Unit
V_{RRM}	Repetitive peak reverse voltage		300	V
$I_{F(RMS)}$	RMS forward current		30	A
$I_{F(AV)}$	Average forward current	$T_c = 120^\circ\text{C}$ $\delta = 0.5$	Per diode 15 Per device 30	A
I_{FSM}	Surge non repetitive forward current	$t_p = 10$ ms sinusoidal	120	A
T_{stg}	Storage temperature range		- 65 + 175	°C
T_j	Maximum operating junction temperature		+ 175	°C

THERMAL AND POWER DATA

Symbol	Parameter		Value	Unit
R _{th (j-c)}	Junction to case	Per diode	2.0	°C/W
		Total	1.2	
R _{th (c)}		Coupling	0.4	

STATIC ELECTRICAL CHARACTERISTICS

Symbol	Parameter	Tests conditions		Min.	Typ.	Max.	Unit
I _R *	Reverse leakage current	V _R = V _{RRM}	T _j = 25°C			20	μA
			T _j = 125°C		30	200	
V _F **	Forward voltage drop	I _F = 15 A	T _j = 25°C			1.9	V
			T _j = 125°C		1.1	1.4	

Pulse test : * t_p = 5 ms, δ < 2 %

** t_p = 380 μs, δ < 2%

To evaluate the maximum conduction losses use the following equation :

$$P = 1 \times I_{F(AV)} + 0.026 I_{F(RMS)}^2$$

RECOVERY CHARACTERISTICS

Symbol	Tests conditions		Min.	Typ.	Max.	Unit
t _{rr}	I _F = 0.5 A I _{rr} = 0.25 A I _R = 1A	T _j = 25°C		20		ns
	I _F = 1 A dI _F /dt = - 50 A/μs V _R = 30V				35	
I _{RM}	V _R = 200 V I _F = 15A dI _F /dt = - 200A/μs	T _j = 125°C		4.5	6	A
S factor				0.4		

TURN-ON SWITCHING CHARACTERISTICS

Symbol	Tests conditions	Min.	Typ.	Max.	Unit
t _{fr}	T _j = 25°C I _F = 15A dI _F /dt = 100A/μs measured at 1.1xV _{Fmax}			300	ns
V _{FP}	T _j = 25°C I _F = 15A dI _F /dt = 100A/μs			3.5	V

Fig. 1: Conduction losses versus average current

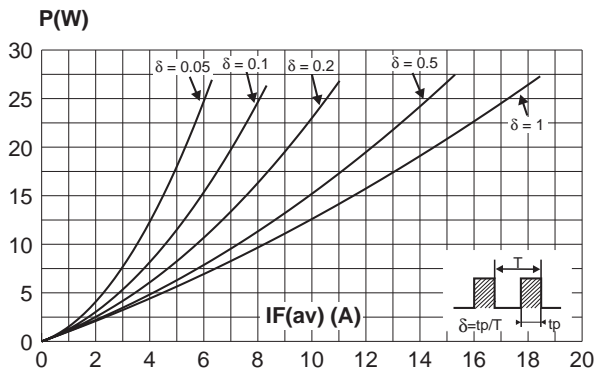

Fig. 2: Forward voltage drop versus forward current

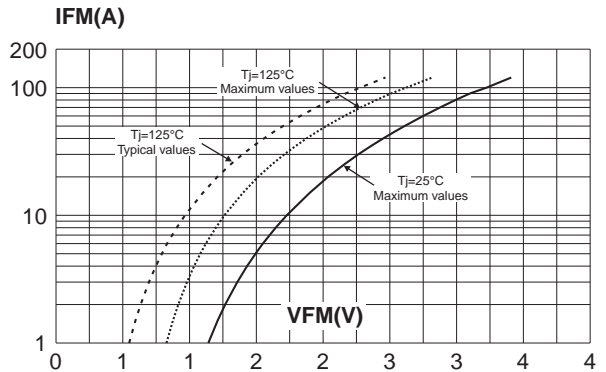

Fig. 3: Relative variation of thermal impedance junction to case versus pulse duration

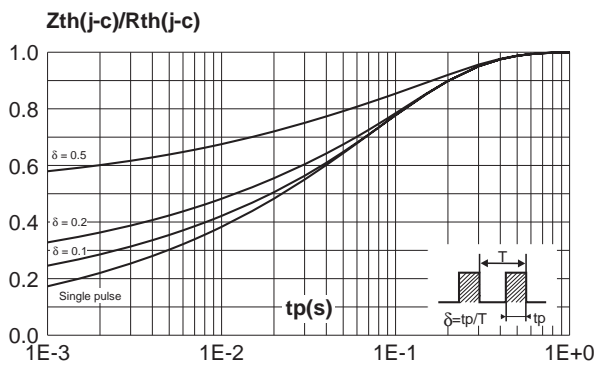

Fig. 4: Peak reverse recovery current versus dIF/dt (90% confidence)

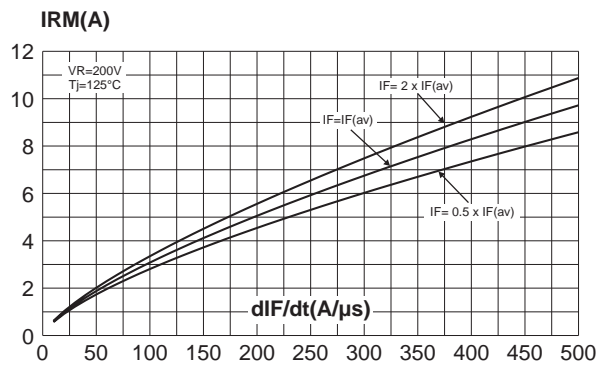

Fig. 5: Reverse recovery time versus dIF/dt (90% confidence)

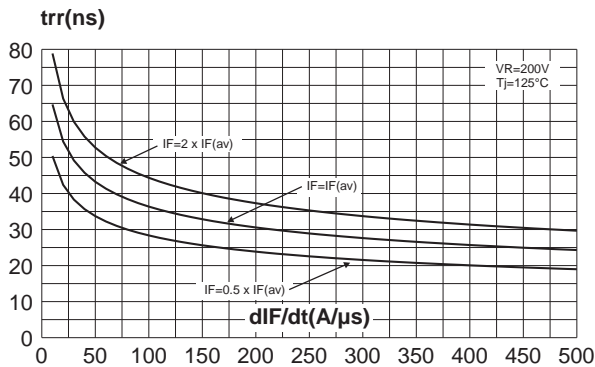

Fig. 6: Reverse recovery charges versus dIF/dt (90% confidence)

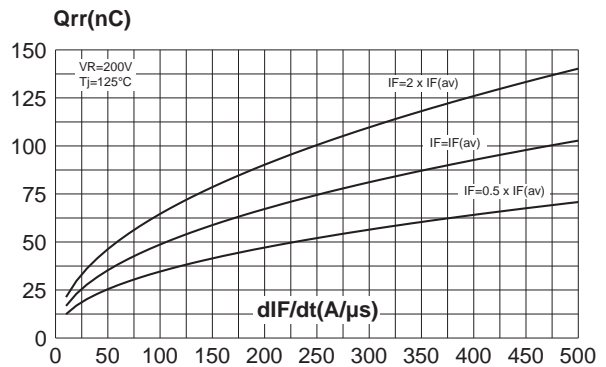

Fig. 7: Softness factor (tb/ta) versus dI_F/dt (typical values).

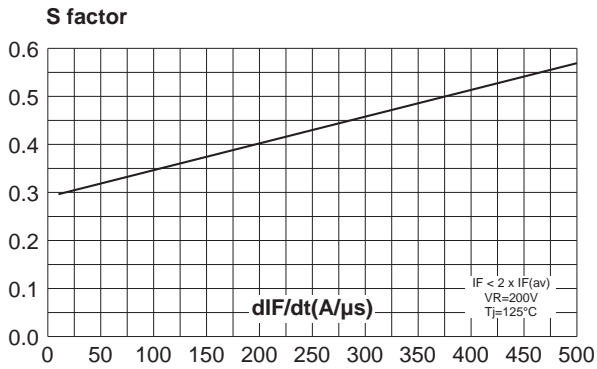

Fig. 8: Relative variation of dynamic parameters versus junction temperature (Reference: $T_j=125^\circ\text{C}$).

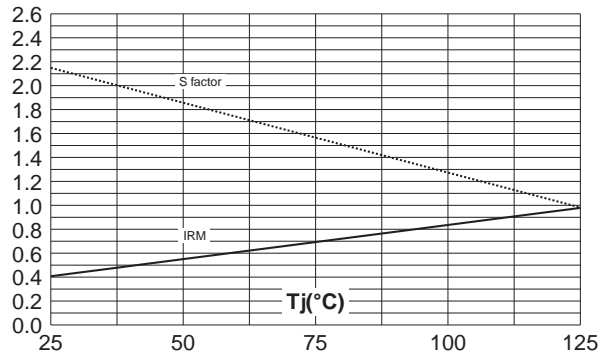

Fig. 9: Transient peak forward voltage versus dI_F/dt (90% confidence).

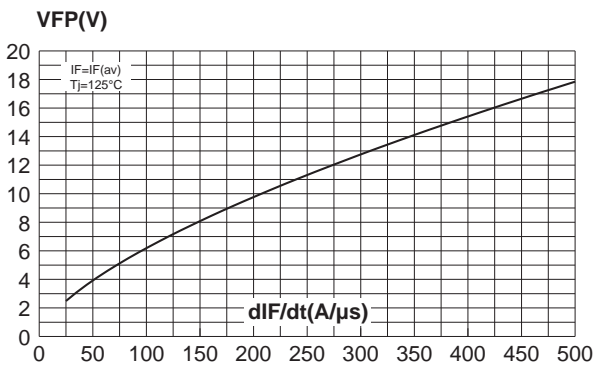
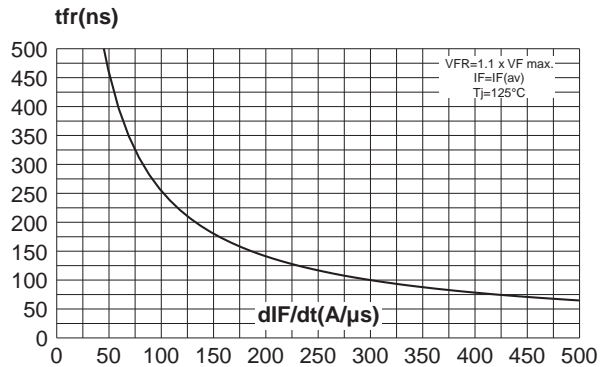
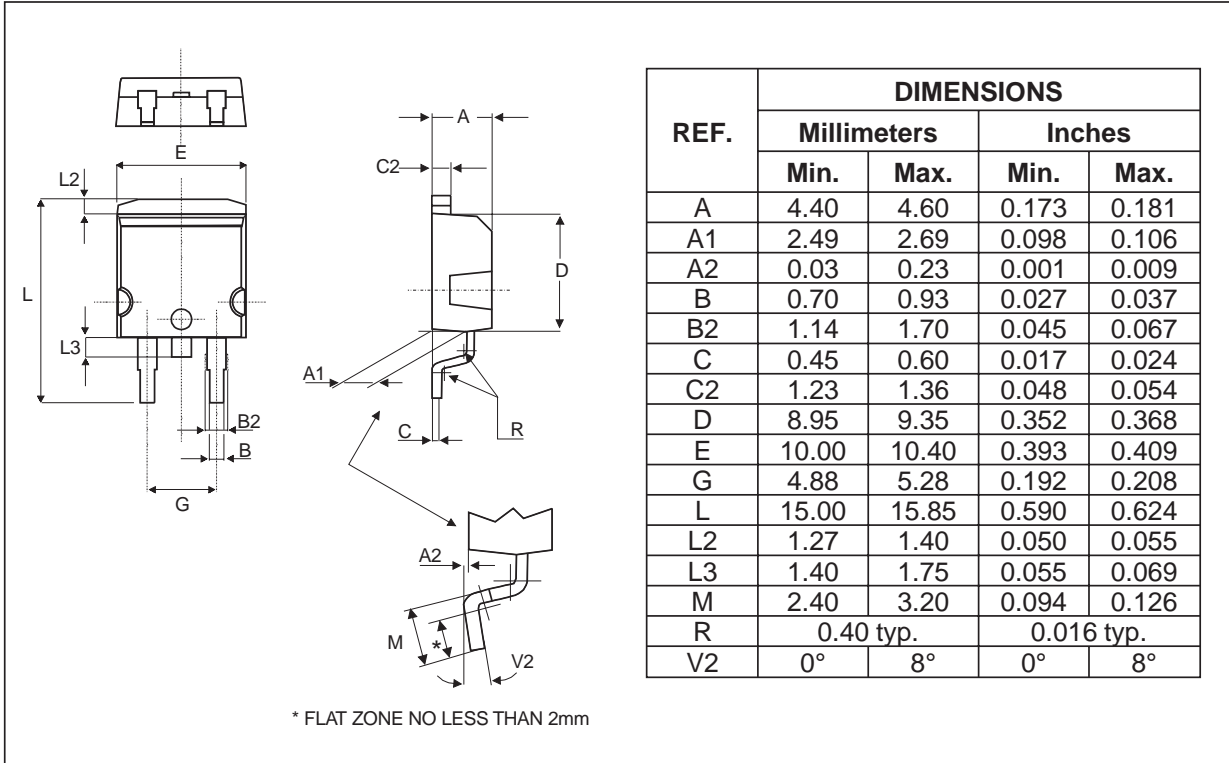

Fig. 10: Forward recovery time versus dI_F/dt (90% confidence).



PACKAGE MECHANICAL DATA

D²PAK



FOOTPRINT

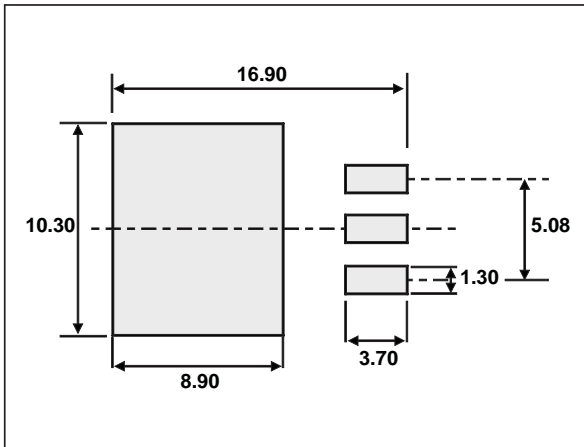

STTH30R03CW/CG

PACKAGE MECHANICAL DATA

TO-247

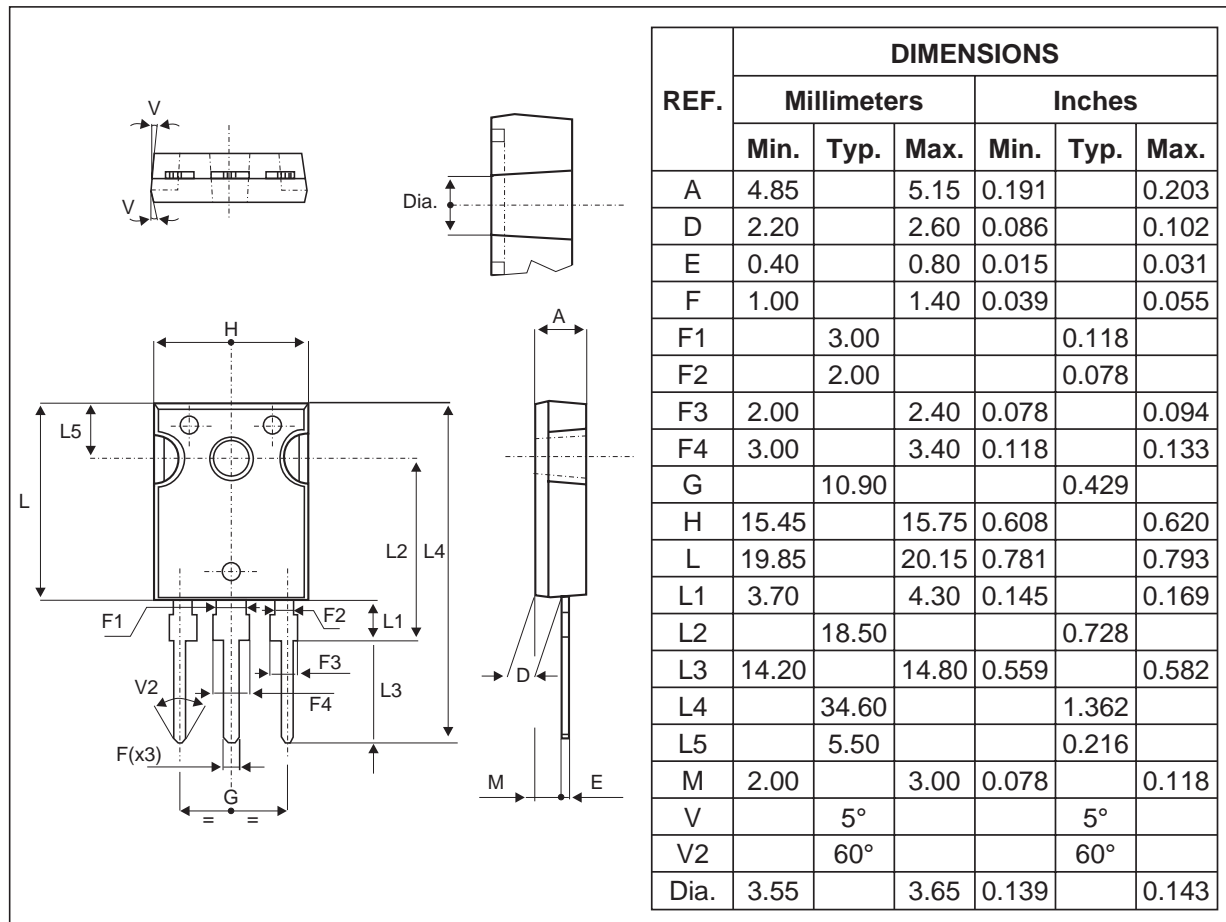

Ordering code	Marking	Package	Weight	Base qty	Delivery mode
STTH30R03CW	STTH30R03CW	TO-247	4.36g	30	Tube
STTH30R03CG	STTH30R03CG	D ² PAK	1.48g	50	Tube
STTH30R03CG-TR	STTH30R03CG	D ² PAK	1.48g	1000	Tape & Reel

- Cooling method: by conduction (C)
- Recommended torque value: 0.8 N.m.
- Maximum torque value: 1 N.m.
- Epoxy meets UL 94,V0

Information furnished is believed to be accurate and reliable. However, STMicroelectronics assumes no responsibility for the consequences of use of such information nor for any infringement of patents or other rights of third parties which may result from its use. No license is granted by implication or otherwise under any patent or patent rights of STMicroelectronics. Specifications mentioned in this publication are subject to change without notice. This publication supersedes and replaces all information previously supplied. STMicroelectronics products are not authorized for use as critical components in life support devices or systems without express written approval of STMicroelectronics.

The ST logo is a registered trademark of STMicroelectronics

© 2002 STMicroelectronics - Printed in Italy - All rights reserved.

STMicroelectronics GROUP OF COMPANIES

Australia - Brazil - Canada - China - Finland - France - Germany
 Hong Kong - India - Israel - Italy - Japan - Malaysia - Malta - Morocco - Singapore
 Spain - Sweden - Switzerland - United Kingdom - United States.

<http://www.st.com>

