

TPS5442x5 Step-Down Converter Evaluation Module User's Guide



Table of Contents

1 Introduction	3
2 Description	3
2.1 Typical End-User Applications.....	3
2.2 EVM Features.....	3
3 EVM Electrical Performance Specifications	3
4 Schematic	4
5 Test Setup	5
5.1 Test and Configuration Software.....	5
5.2 Test Equipment.....	5
5.3 The PWR-681EVM.....	6
5.4 List of Test Points, Jumpers and Switch.....	7
6 EVM Configuration Using the Fusion GUI	8
6.1 Configuration Procedure.....	9
7 Test Procedure	10
7.1 Line/Load Regulation Measurement Procedure.....	10
7.2 Efficiency.....	10
7.3 Bode Plot Measurement Procedure.....	10
7.4 Equipment Shutdown.....	10
8 Performance Data and Typical Characteristic Curves	11
8.1 Efficiency.....	11
8.2 Load Regulation.....	11
8.3 Line Regulation.....	12
8.4 Transient Response.....	12
8.5 Output Ripple.....	13
8.6 Control On.....	14
8.7 Control Off.....	15
8.8 Overcurrent Protection.....	15
8.9 Control Loop Bode Plot.....	16
8.10 Thermal Image.....	17
9 Fusion GUI	18
10 EVM Assembly Drawing and PCB Layout	39
11 List of Materials	42
12 Revision History	43

List of Figures

Figure 4-1. PWR-681EVM Schematic.....	4
Figure 5-1. PWR-681EVM Overview.....	6
Figure 5-2. Tip and Barrel Measurement.....	6
Figure 8-1. Efficiency of 0.95-V Output vs Line and Load.....	11
Figure 8-2. Load Regulation of 0.95-V Output.....	11
Figure 8-3. Line Regulation of 0.95-V Output.....	12
Figure 8-4. Transient Response of 0.95-V Output at 12 V _{IN} , Transient is 0 A to 20 A, 2.5 A/μs.....	12
Figure 8-5. Output Ripple and SW Node of 0.95-V Output at 12 V _{IN} , 0-A Output.....	13
Figure 8-6. Output Ripple and SW Node of 0.95-V Output at 12 V _{IN} , 20-A Output.....	13
Figure 8-7. Start up from Control, 0.95-V Output at 12 V _{IN} , 20-A Output.....	14
Figure 8-8. 0.5-V Pre-bias start up from Control, 0.95-V Output at 12 V _{IN} , 0-A Output.....	14
Figure 8-9. Soft Stop from Control, 0.95-V Output at 12 V _{IN} , 20-A Output.....	15
Figure 8-10. Overcurrent Protection, 0.95-V Output at 12 V _{IN} , 36-A Output.....	15
Figure 8-11. Restart from Overcurrent Protection, 0.95-V Output at 12 V _{IN}	16

Figure 8-12. Bode Plot at 0.95-V Output at 12 V _{IN} , 20-A Output.....	16
Figure 8-13. Thermal Image at 0.95-V Output at 12 V _{IN} , 20-A Output.....	17
Figure 8-14. Thermal Image at 0.95-V Output at 12 V _{IN} , 30-A Output.....	17
Figure 9-1. First Window at Fusion Launch.....	18
Figure 9-2. Scan Finds Device Successfully.....	18
Figure 9-3. Software Launch Continued.....	19
Figure 9-4. Software Launch Continued.....	19
Figure 9-5. First Screen After Successful Launch Configure: Limits and On/Off.....	20
Figure 9-6. Configure: Limits and On/Off- On/Off Configuration Pop-up.....	21
Figure 9-7. Configure: Limits and On/Off- On/Off Config Pop-Up with Change.....	22
Figure 9-8. Configure: Advanced.....	23
Figure 9-9. Configure: Device Info.....	24
Figure 9-10. Configure: SMBALERT # Mask.....	25
Figure 9-11. Configure: All.....	26
Figure 9-12. Configure: All Config- On/Off Config Pop-up.....	27
Figure 9-13. Configure: <i>Store Config to NVM</i>	28
Figure 9-14. Change View Screen to Monitor Screen.....	29
Figure 9-15. Monitor Screen.....	30
Figure 9-16. System Dashboard.....	31
Figure 9-17. Status Screen.....	32
Figure 9-18. Import Project / Import Configuration File.....	33
Figure 9-19. Store Configuration To Memory.....	34
Figure 9-20. Data Logging.....	35
Figure 9-21. Data Log File.....	36
Figure 9-22. PMBus Logging.....	37
Figure 9-23. PMBus Log Details.....	38
Figure 10-1. PWR-681EVM Top Layer Assembly Drawing (top view).....	39
Figure 10-2. PWR-681EVM Top Layer (top view).....	39
Figure 10-3. PWR-681EVM Layer 1 (top view).....	40
Figure 10-4. PWR-681EVM Layer 2 (top view).....	40
Figure 10-5. PWR-681EVM Bottom Layer (top view).....	41
Figure 10-6. PWR-681EVM Bottom Layer Assembly Drawing (top view).....	41

List of Tables

Table 3-1. PWR-681EVM Electrical Performance Specifications.....	3
Table 5-1. The Function of Each Test Point.....	7
Table 6-1. Key Factory Configuration Parameters.....	8
Table 7-1. List of Test Points for Line/Load Measurements.....	10
Table 7-2. List of Test Points for Efficiency Measurements.....	10
Table 11-1. PWR681 List of Materials	42

Trademarks

All trademarks are the property of their respective owners.

1 Introduction

The PWR681EVM evaluation module uses either the TPS544B25 or TPS544C25 devices. The TPS544B25 and TPS544C25 are highly integrated synchronous buck converters that are designed for up to 20-A or 30-A current output, respectively.

2 Description

The PWR681EVM is designed as a single output DC-DC converter that demonstrates either the TPS544B25 or the TPS544C25 in a typical low-voltage application while providing a number of test points to evaluate the performance. It uses a nominal 12-V input bus to produce a regulated 0.95-V output at up to either 20-A or 30-A of load current, depending on the device installed.

2.1 Typical End-User Applications

- High-Density Power Solutions
- Communications Equipment
- Servers and Computing Equipment
- Smart Power Systems

2.2 EVM Features

- Regulated 0.95-V output up to 30-ADC, steady-state output current
- Configurable features via the PMBus interface include:
 - Programmable Output Voltage via the PMBus Interface
 - Programmable UVLO, Soft Start, and Enable via the PMBus Interface
 - Programmable Overcurrent Warning, Fault Limits and Programmable Response to Faults via the PMBus Interface
 - Programmable Overvoltage, Undervoltage Warning, Fault Limit and Programmable Response to Faults via the PMBus Interface
 - Programmable external Overtemperature Warning, Fault Limit and Programmable Response to Faults via the PMBus Interface
- Convenient Test Points for Probing Critical Waveforms
- Optional External Temperature Sensor

3 EVM Electrical Performance Specifications

Table 3-1. PWR-681EVM Electrical Performance Specifications

PARAMETER		TEST CONDITIONS	MIN	TYP	MAX	UNITS
Input Characteristics						
Voltage range		V_{IN}	4.5	12	18	V
Maximum input current		$V_{IN} = 8\text{ V}, I_O = 30\text{ A}$			5	A
No load input current		$V_{IN} = 12\text{ V}, I_O = 0\text{ A}$		42		mA
Output Characteristics						
V_{OUT}	Output voltage	Output current = 10 A		0.95		V
I_{OUT}	Output load current	$I_{OUT(min)}$ to $I_{OUT(max)}$	0		30	A
Output voltage regulation		Line regulation: input voltage = 4.5 V to 18 V		0.5%		
		Load regulation: output current = 0 A to $I_{OUT(max)}$		0.5%		
V_{OUT}	Output voltage ripple	$V_{IN} = 12\text{ V}, I_{OUT} = 30\text{ A}$		20		mV _{PP}
V_{OUT}	Output overcurrent			36		A
Systems Characteristics						
Switching frequency		F_{SW}		500		kHz
V_{OUT}	Peak efficiency	$V_{IN} = 12\text{ V}, I_O = 13\text{ A}, F_{SW} = 500\text{ kHz}$		88%		
Operating temperature		T_{oper}	0		105	°C

4 Schematic

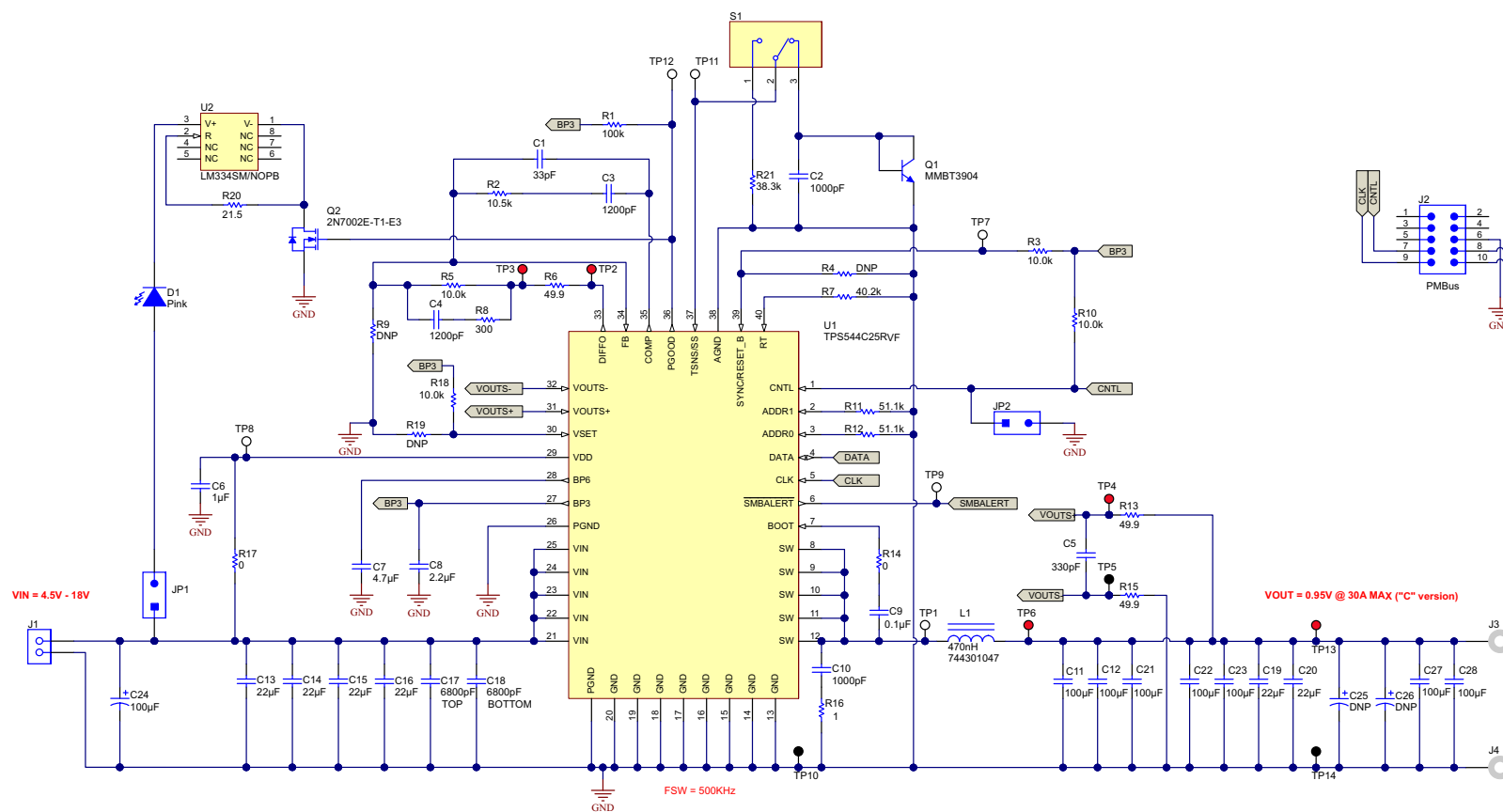

Figure 4-1. PWR-681EVM Schematic

5 Test Setup

5.1 Test and Configuration Software

To change any of the default configuration parameters on the EVM, it is necessary to obtain the TI Fusion Digital Power Designer software. This can be downloaded from the TI website.

5.1.1 Description

The Fusion Digital Power Designer is the graphical user interface (GUI) used to configure and monitor the Texas Instruments TPS544B25 or TPS544C25 power converter installed on this evaluation module. The application uses the PMBus protocol to communicate with the controller over serial bus by way of a TI USB adapter. This adapter can be purchased at <http://www.ti.com/tool/usb-to-gpio>.

Note

The TI USB adapter must be purchased separately. It is not included with this EVM kit.

5.1.2 Features

Some of the tasks performed with the GUI include:

- Turn on or off the power supply output, either through the hardware control line or the PMBus operation command.
- Monitor real-time data. Items such as input voltage, output voltage, output current, temperature, and warnings and faults are continuously monitored and displayed by the GUI.
- Configure common operating characteristics such as V_{OUT}, UVLO, soft-start time, warning and fault thresholds, fault response, and ON/OFF.

This software is available for download at http://www.ti.com/tool/fusion_digital_power_designer

5.2 Test Equipment

Voltage Source: The input voltage source V_{IN} must be a 0-V to 18-V variable dc source capable of supplying at least 8 A_{DC}. Connect V_{IN} to J1 [Figure 5-1](#).

Multimeters: It is recommended to use two separate multimeters [Figure 5-1](#). One meter is used to measure V_{IN} and one to measure V_{OUT}.

Output Load: A variable electronic load is recommended for testing [Figure 5-1](#). It must be capable of 30 A at voltages as low as 0.9 V.

Oscilloscope: An oscilloscope is recommended for measuring output noise and ripple. Output ripple must be measured using a tip-and-barrel method or better as shown in [Figure 5-2](#). The scope must be adjusted to 20-MHz bandwidth, ac coupling at 50 mV/division, and must be set to 1-μs/division.

Fan: During prolonged operation at high loads, it may be necessary to provide forced air cooling with a small fan aimed at the EVM. Temperature of the devices on the EVM must be maintained below 105°C.

USB-to-GPIO Interface Adapter: A communications adapter is required between the EVM and the host computer. This EVM was designed to use the Texas Instruments USB-to-GPIO Adapter. This adapter can be purchased at <http://www.ti.com/tool/usb-to-gpio>.

Recommended Wire Gauge: The voltage drop in the load wires must be kept as low as possible in order to keep the working voltage at the load within its operating range. See the following table for recommended wire gauge and length to achieve a voltage drop of no more than 0.2 V at the maximum 30-A load.

AWG GAUGE	OHMS PER FOOT (Ω)	LOAD WIRES COMBINED LENGTH (Ft)	EACH WIRE LENGTH (Ft)
12	1.59E-3	6.30	3.15
14	2.53E-3	3.96	1.98
16	4.02E-3	2.49	1.25
18	6.39E-3	1.57	0.78

Note

If AWG 12 wire is used, no more than 3.15 feet of wire must be used between the EVM and the load.

5.3 The PWR-681EVM

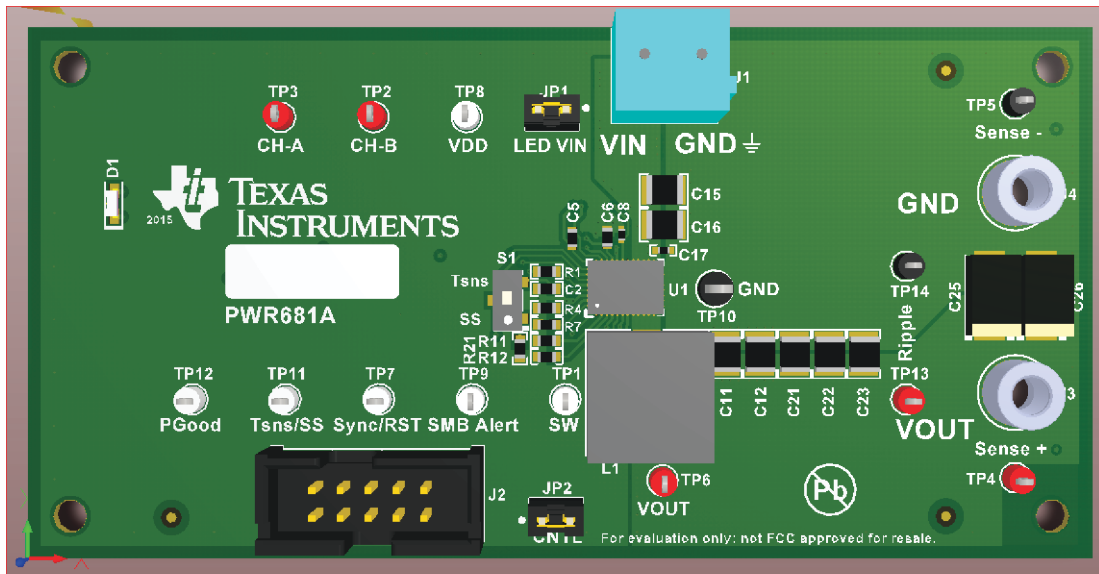
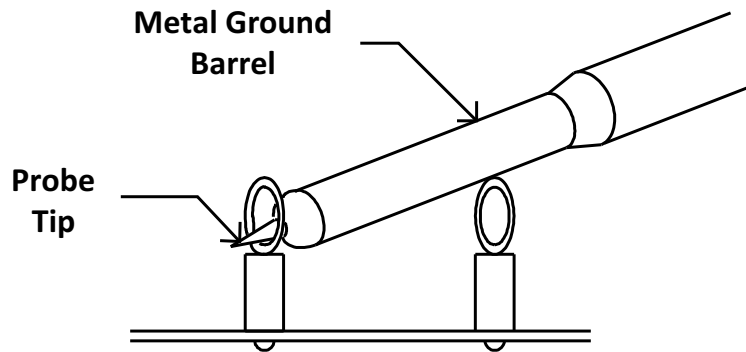

Figure 5-1. PWR-681EVM Overview



Tip and Barrel V_{OUT} Ripple Measurement

Figure 5-2. Tip and Barrel Measurement

5.4 List of Test Points, Jumpers and Switch

Table 5-1. The Function of Each Test Point

ITEM	TYPE	NAME	DESCRIPTION
TP1	T-H loop	SW	Power supply Switch Node
TP2	T-H loop	CH-B	Measure loop stability
TP3	T-H loop	CH-A	Measure loop stability
TP4	T-H loop	V _{sense} +	Remote sense +
TP5	T-H loop	V _{sense} –	Remote sense –
TP6	T-H loop	V _{out}	Use this V _{OUT} for efficiency measurements
TP7	T-H loop	SYNC/RST	Input a sync signal from a clock source; or apply logic low signal to RESET V _{OUT} to initial boot-up voltage set by VSET pin. Refer to the Datasheet for details.
TP8	T-H loop	VDD	Supplies the internal circuitry
TP9	T-H loop	SMB_Alert	Monitor alerts
TP10	T-H loop	GND	Common GND
TP11	T-H loop	Tsns/SS	Monitor the voltage on the TSNS/SS pin
TP12	T-H loop	PGOOD	PGOOD (also drives LED lamp)
TP13	T-H loop	V _{OUT}	Use for tip-barrel ripple measurement
TP14	T-H loop	GND	Use for tip-barrel ripple measurement
JP1	2-pin jumper	LED Vin	Remove jumper to measure Vin for efficiency. Replace jumper and LED lights with PGOOD.
JP2	2-pin jumper	CNTL	Shunts control pin to GND (turns off the IC for default configuration of ON_OFF_CONFIG, refer to the Datasheet for details)
S1	SPDT switch	TSNS and SS Switch	Switch between external temperature sensor and SS resistor to be connected to TSNS/SS pin

6 EVM Configuration Using the Fusion GUI

The TPS544B25 or TPS544C25 installed on this EVM leave the factory pre-configured. See [Table 6-1](#) for a short list of key factory configuration parameters as obtained from the configuration file.

Table 6-1. Key Factory Configuration Parameters

ADDRESS HEX	ADDRESS DEC	PART ID		
0x24	36	TPS544x25		
GENERAL				
CMD Code	CMD CODE HEX	ENCODED HEX	DECODED	COMMENTS
VIN_OFF	0x36	0xF010	4.0 V	Turn OFF voltage
VIN_ON	0x35	0xF012	4.5 V	Turn ON voltage
IOUT_CAL_OFFSET	0x39	0xE000	0.0000 A	Current offset for GUI readout
IOUT_OC_FAULT_LIMIT	0x46	0xF848 (TPS544C25)	36 A	OC fault level
		0xF830 (TPS544B25)	24 A	
IOUT_OC_FAULT_RESPONSE	0x47	0xBF	Restart	Response to OC fault
IOUT_OC_WARN_LIMIT	0x4A	0xF844 (TPS544C25)	34 A	OC warning level
		0xF82C (TPS544B25)	22 A	
VOUT_COMMAND	0x21	0x01E6	0.95 V	output voltage
VOUT_MAX	0x24	0x0300	1.5 V	maximum output voltage
VOUT_TRANSITION_RATE	0x27	0xD03C	1 mV/us	Vout transition rate
VOUT_SCALE_LOOP	0x29	0xF004	1	Output sense scaling ratio for main control loop
VOUT_OV_FAULT_LIMIT	0x40	0x0290	1.281 V	Output overvoltage fault threshold
VOUT_OV_FAULT_RESPONSE	0x41	0xBF	Restart	Output overvoltage fault response
VOUT_OV_WARN_LIMIT	0x42	0x0267	1.201 V	Output overvoltage warn threshold
VOUT_UV_WARN_LIMIT	0x43	0x0143	0.631 V	Output undervoltage warn threshold
VOUT_UV_FAULT_LIMIT	0x44	0x0130	0.594 V	Output undervoltage fault threshold
VOUT_UV_FAULT_RESPONSE	0x45	0xBF	Restart	Output undervoltage fault response
ON_OFF_CONFIG	0x02	0x16	CNTL only, Active High	Control signal and operation command not required
OPERATION	0x01	0x00	Operation is not used to enable regulation; Unit: immediate off	
OT_FAULT_LIMIT	0x4F	0x007D	125°C	OT fault level
OT_WARN_LIMIT	0x51	0x0064	100°C	OT warn level
TON_DELAY	0x60	0x0000	0 ms	Turn-on delay
TON_RISE	0x61	0x0005	5 ms	Soft-start time
TON_MAX_FAULT_LIMIT	0x62	0x0064	100 ms	Upper limit for Vout reaching regulation
TOFF_DELAY	0x64	0x0000	0 ms	Turn-off delay
TOFF_FALL	0x65	0x0000	1 ms	Soft-stop fall time
MFR_VOUT_MIN	0xA4	0x0100	0.5 V	minimum output voltage

If it is desired to configure the EVM to settings other than the factory settings shown in [Table 6-1](#), the TI Fusion Digital Power Designer software can be used for reconfiguration. It is necessary to have input voltage applied to the EVM prior to launching the software so that the TPS544B25 or TPS544C25 installed is active and able to respond to the GUI and the GUI can recognize the device. The default configuration for the EVM is to start converting at an input voltage of 4.5 V; therefore, to avoid any converter activity during configuration, an input voltage less than 4.5 V must be applied. An input voltage of 4 V is recommended.

6.1 Configuration Procedure

1. Adjust the input supply to provide 4 V_{DC}, current limited to 1 A_{DC}.
2. Apply the input voltage to the EVM. See [Figure 5-1](#) for overview of the EVM and its connections.
3. Launch the Fusion GUI software. See the screen shots in [Section 9](#) for more information.
4. Configure the EVM operating parameters as desired.
5. VSET pin is pulled up to BP3 on the EVM, so the VOUT_COMMAND at boot up is restored from the internal EEPROM. The SYNC/RESET_B pin is configured to SYNC function under this setup. In order to use VSET or RESET_B function, proper resistor of R19 should be populated and resistor R18 should be removed. Please see Datasheet for more details.
6. S1 on the EVM provides the option to use the external temperature sensor Q1 on the EVM.

Note

To read the external temperature value on PMBus, the bit 8 (SS_DET_DIS) in (E5h) MFR_SPECIFIC_21 register needs to be set to 1. Otherwise, the READ_TEMPERATURE_2 will always return 25°C.

7. With an input of 4 V_{DC}, the internal configuration circuitry will be powered and active but the device will still be in UVLO and outputs off.

7 Test Procedure

7.1 Line/Load Regulation Measurement Procedure

1. Ensure that the electronic load is set to draw 0 A_{DC}.
2. Increase V_{IN} from 0 V to 12 V using the digital multimeter to measure input voltage.
3. Use the other digital multimeter to measure output voltage V_{OUT} at TP4 and TP5.

Table 7-1. List of Test Points for Line/Load Measurements

TEST POINT	NODE NAME	DESCRIPTION
JP1	VIN	Measurement point for VIN +VE (remove the jumper, LED will not light)
TP10	GND	Measurement point for VIN –VE
TP4	V_sense +	Measurement point for VOUT +VE
TP5	V_sense -	Measurement point for VOUT –VE

4. Vary the load from 0 A_{DC} to maximum rated output A_{DC} (TPS544B25 = 20 A, TPS544C25 = 30 A) . V_{OUT} must remain in regulation as defined in [Table 3-1](#).
5. Vary V_{IN} from 4.5 V to 18 V. V_{OUT} must remain in regulation as defined in [Table 3-1](#).
6. Decrease the load to 0 A.
7. Decrease V_{IN} to 0 V or turn off the supply.

7.2 Efficiency

To measure the efficiency of the power train on the EVM, it is important to measure the voltages at the correct location. This is necessary because otherwise the measurements will include losses in efficiency that are not related to the power train itself. Losses incurred by the voltage drop in the copper traces and in the input and output connectors are not related to the efficiency of the power train, and they must not be included in efficiency measurements.

Table 7-2. List of Test Points for Efficiency Measurements

TEST POINT	NODE NAME	DESCRIPTION
JP1	VIN	Measurement point for VIN +VE (remove the jumper, LED will not light)
TP10	GND	Measurement point for VIN –VE
TP6	VOUT	Measurement point for VOUT +VE
TP10	GND	Measurement point for VOUT –VE

Input current can be measured at any point in the input wires, and output current can be measured anywhere in the output wires of the output being measured. Using these measurement points result in efficiency measurements that do not include losses due to the connectors and PCB traces.

7.3 Bode Plot Measurement Procedure

1. Follow [Section 7.1](#) to set VIN and Load to desired operating condition.
2. Connect the AC small signal injection out of isolation transformer to test points TP2 and TP3.
3. Connect input signal amplitude measurement probe (Channel A) to TP3.
4. Connect output signal amplitude measurement probe (Channel B) to TP2.
5. Connect ground lead of Channel A and Channel B to TP10.
6. Inject 10 mV or less signal through the isolation transformer.
7. Sweep the frequency from 500 Hz to 500 kHz with 10-Hz or lower post filter.
8. Control loop gain can be measured by 20 x log (ChannelB/ChannelA).
9. Control loop phase can be measured by the phase difference between Channel A and Channel B.
10. Follow [Section 7.4](#) to power off the device.

7.4 Equipment Shutdown

1. Reduce the load current to 0 A.
2. Reduce input voltage to 0 V.
3. Shut down the external fan if in use.
4. Shut down equipment.

8 Performance Data and Typical Characteristic Curves

Figure 8-1 through Figure 8-13 present typical performance curves for the PWR-681EVM.

8.1 Efficiency

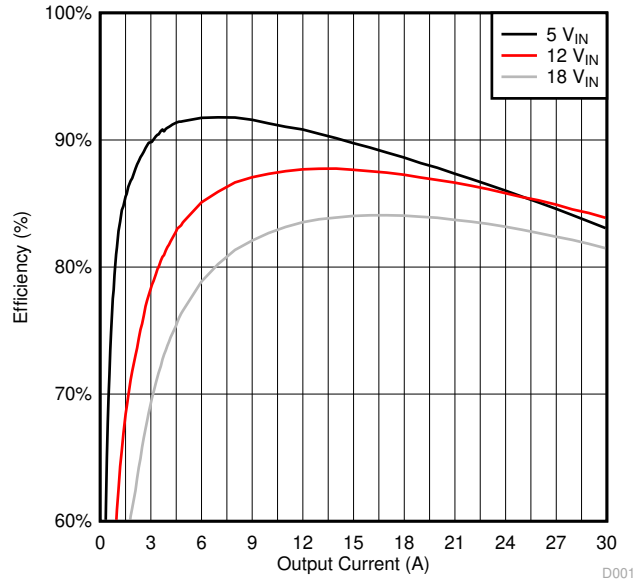

Figure 8-1. Efficiency of 0.95-V Output vs Line and Load

8.2 Load Regulation

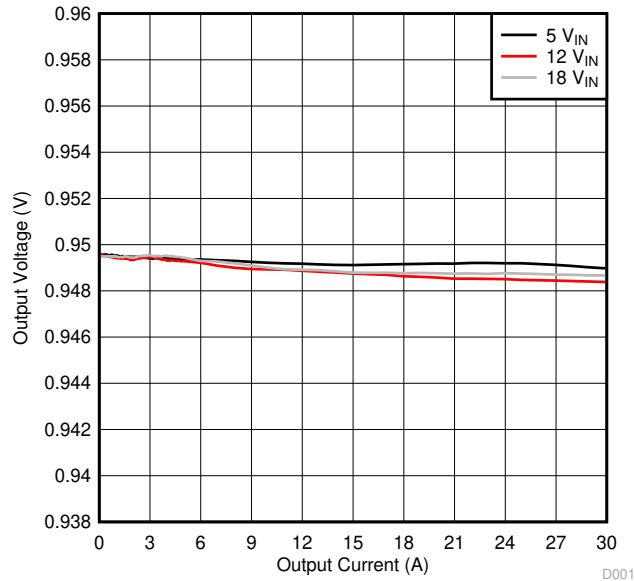

Figure 8-2. Load Regulation of 0.95-V Output

8.3 Line Regulation

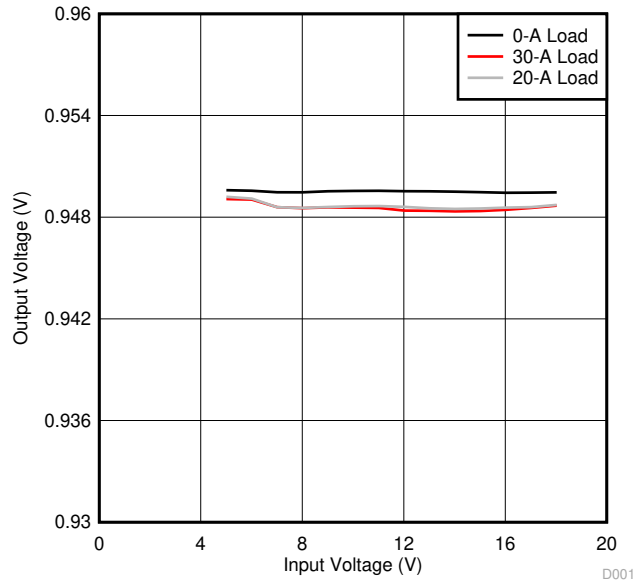
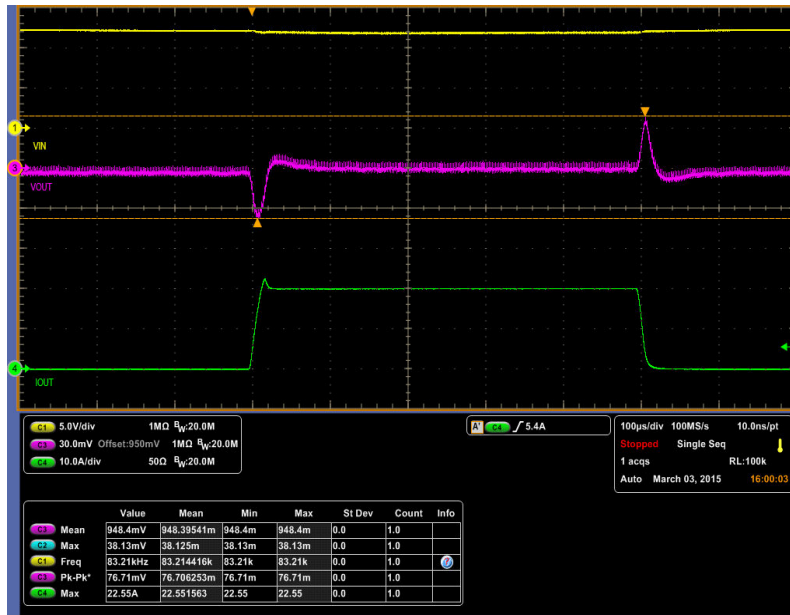

Figure 8-3. Line Regulation of 0.95-V Output

8.4 Transient Response



Ch1 = V_{IN} at 5 V/division, Ch3 = V_{OUT} at 30 mV/division, Ch4 = I_{OUT} at 10 A/division

Figure 8-4. Transient Response of 0.95-V Output at 12 V_{IN} , Transient is 0 A to 20 A, 2.5 A/ μ s

8.5 Output Ripple

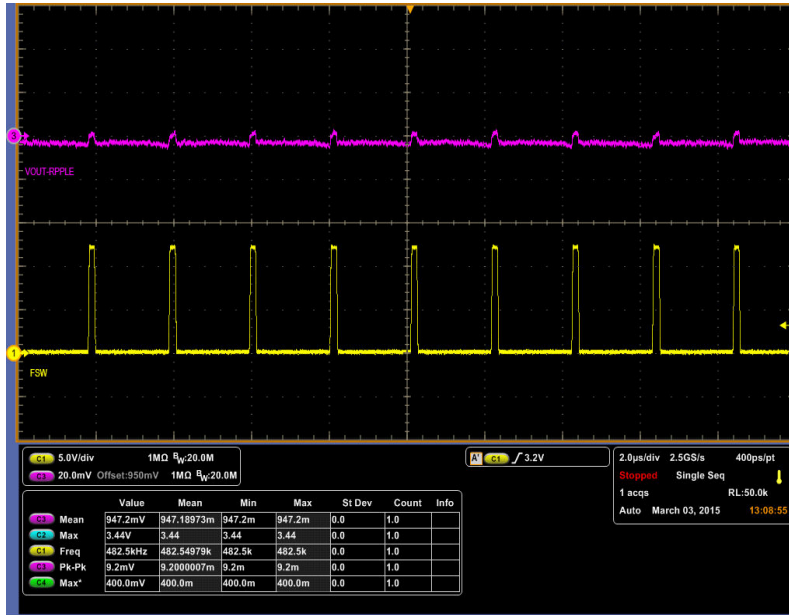

Ch1 = SW at 5 V/division, Ch3 = V_{OUT} ripple at 20 mV/division

Figure 8-5. Output Ripple and SW Node of 0.95-V Output at 12 V_{IN} , 0-A Output

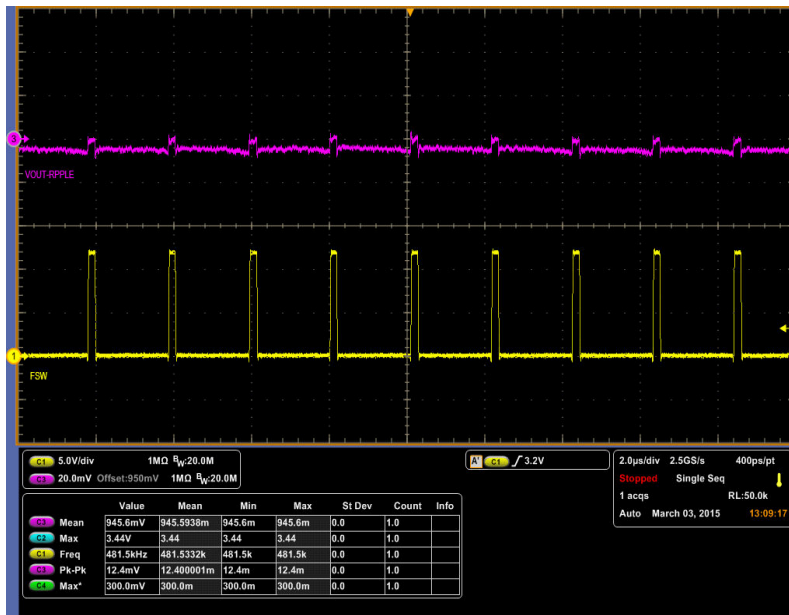

Ch1 = SW at 5 V/division, Ch3 = V_{OUT} ripple at 20 mV/division

Figure 8-6. Output Ripple and SW Node of 0.95-V Output at 12 V_{IN} , 20-A Output

8.6 Control On

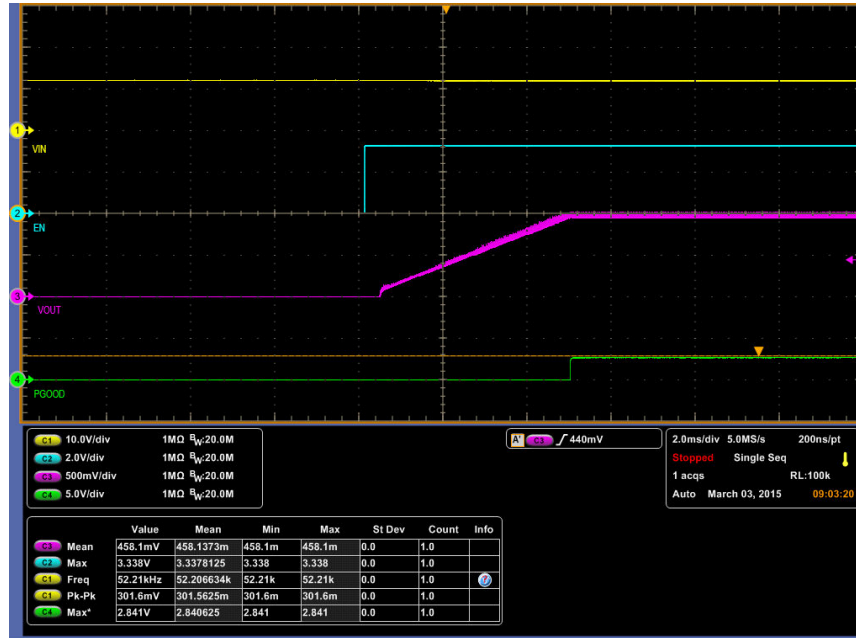

Ch1 = V_{IN} at 10 V/division, Ch2 = CNTL at 2 V/division, Ch3 = V_{OUT} at 500 mV/division, Ch4 = PGOOD at 5 V/division

Figure 8-7. Start up from Control, 0.95-V Output at 12 V_{IN} , 20-A Output



Ch1 = V_{IN} at 10 V/division, Ch2 = CNTL at 2 V/division, Ch3 = V_{OUT} at 500 mV/division, Ch4 = PGOOD at 5 V/division

Figure 8-8. 0.5-V Pre-bias start up from Control, 0.95-V Output at 12 V_{IN} , 0-A Output

8.7 Control Off

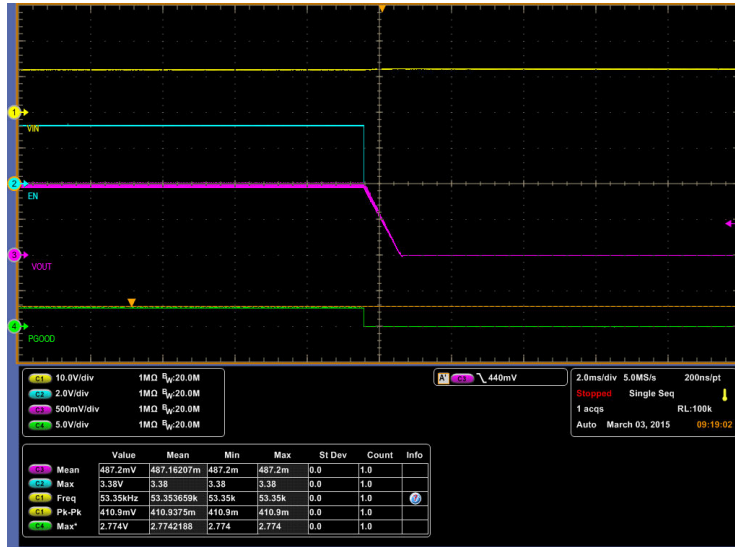

Ch1 = V_{IN} at 10 V/division, Ch2 = CNTL at 2 V/division, Ch3 = V_{OUT} at 500 mV/division, Ch4 = PGOOD at 5 V/division

Figure 8-9. Soft Stop from Control, 0.95-V Output at 12 V_{IN} , 20-A Output

8.8 Overcurrent Protection

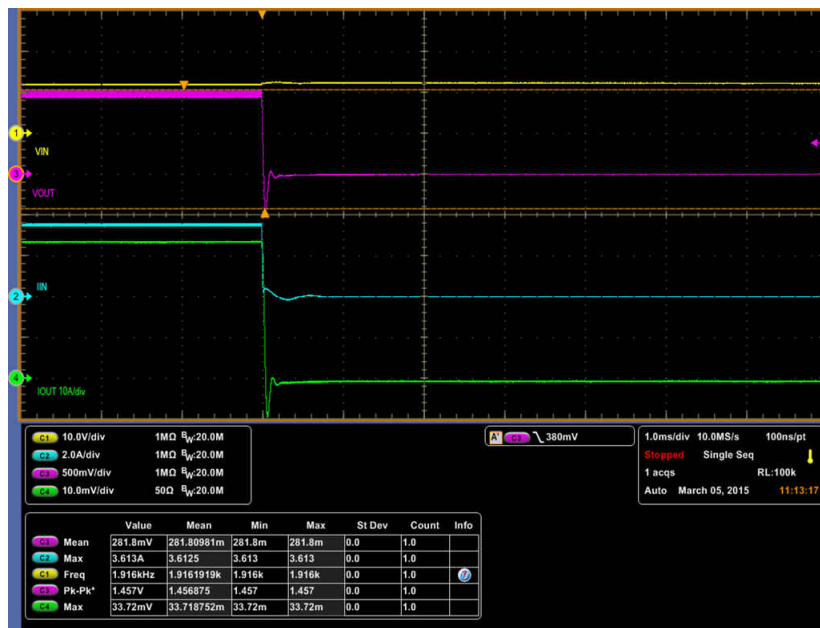

Ch1 = V_{IN} at 10 V/division, Ch2 = I_{IN} at 2 A/division, Ch3 = V_{OUT} at 500 mV/division, Ch4 = I_{OUT} at 10 A/division

Figure 8-10. Overcurrent Protection, 0.95-V Output at 12 V_{IN} , 36-A Output

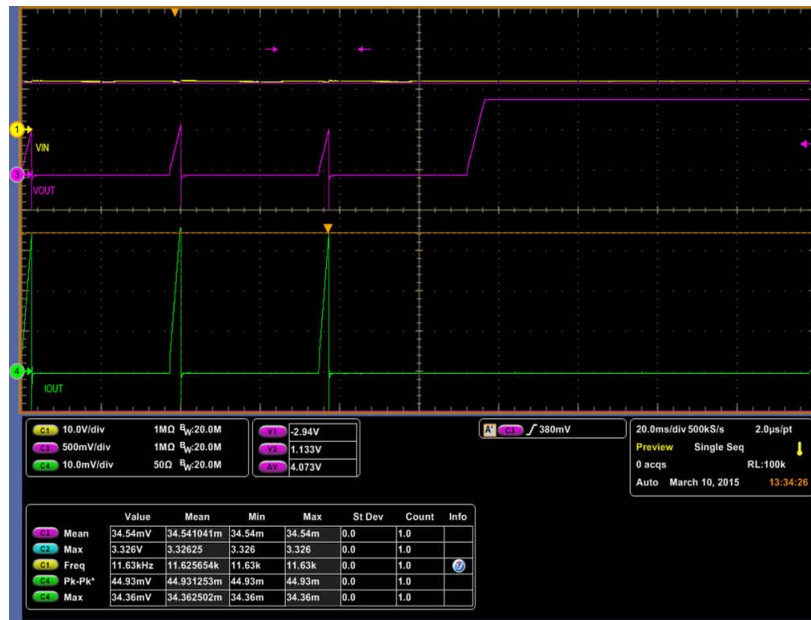

Ch1 = V_{IN} at 10 V/division, Ch2 = I_{IN} at 2 A/division, Ch3 = V_{OUT} at 500 mV/division, Ch4 = I_{OUT} at 10 A/division

Figure 8-11. Restart from Overcurrent Protection, 0.95-V Output at 12 V_{IN}

8.9 Control Loop Bode Plot

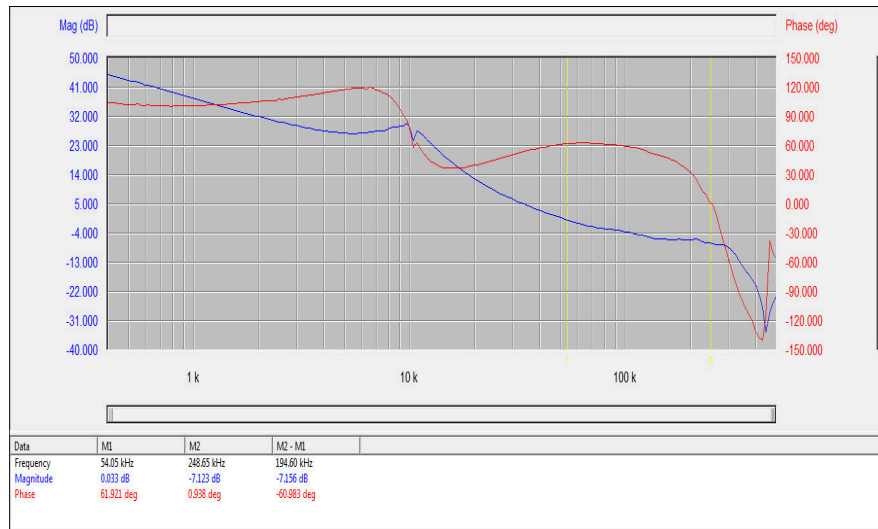

Figure 8-12. Bode Plot at 0.95-V Output at 12 V_{IN} , 20-A Output

8.10 Thermal Image

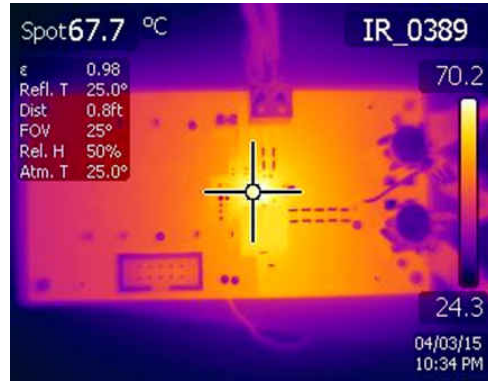

Figure 8-13. Thermal Image at 0.95-V Output at 12 V_{IN}, 20-A Output

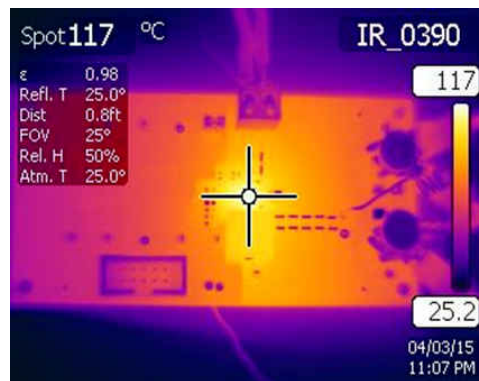

Figure 8-14. Thermal Image at 0.95-V Output at 12 V_{IN}, 30-A Output

9 Fusion GUI

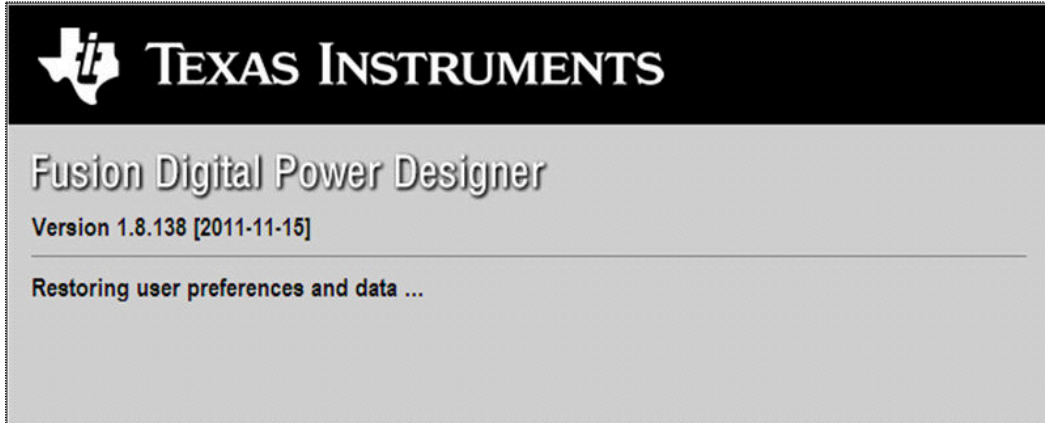

Figure 9-1. First Window at Fusion Launch



Figure 9-2. Scan Finds Device Successfully



Figure 9-3. Software Launch Continued

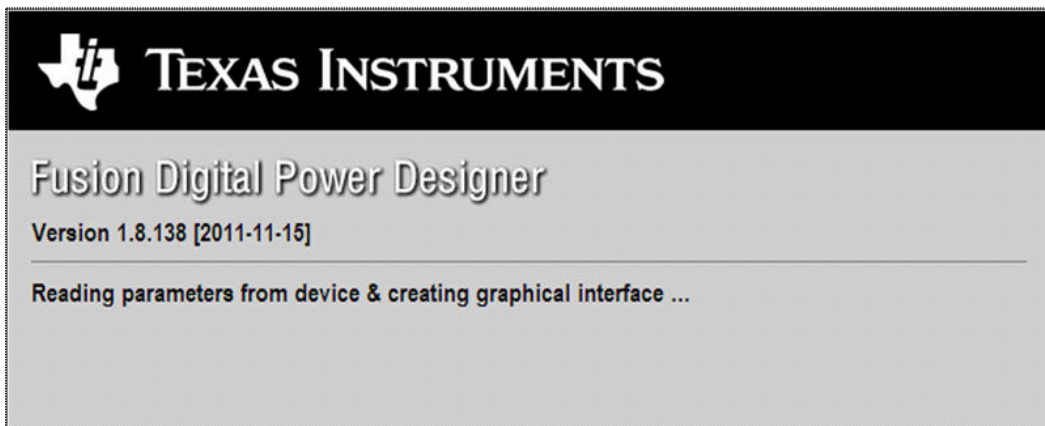

Figure 9-4. Software Launch Continued

Use this next screen to configure (Figure 9-5):

- OV and UV Fault and Warn Limit
- OC Fault and OC Warn Limit
- OT Fault and OT Warn Limit
- Fault Response
- UVLO
- On/Off Configuration
- Sequencing
- V_{OUT} Command Voltage

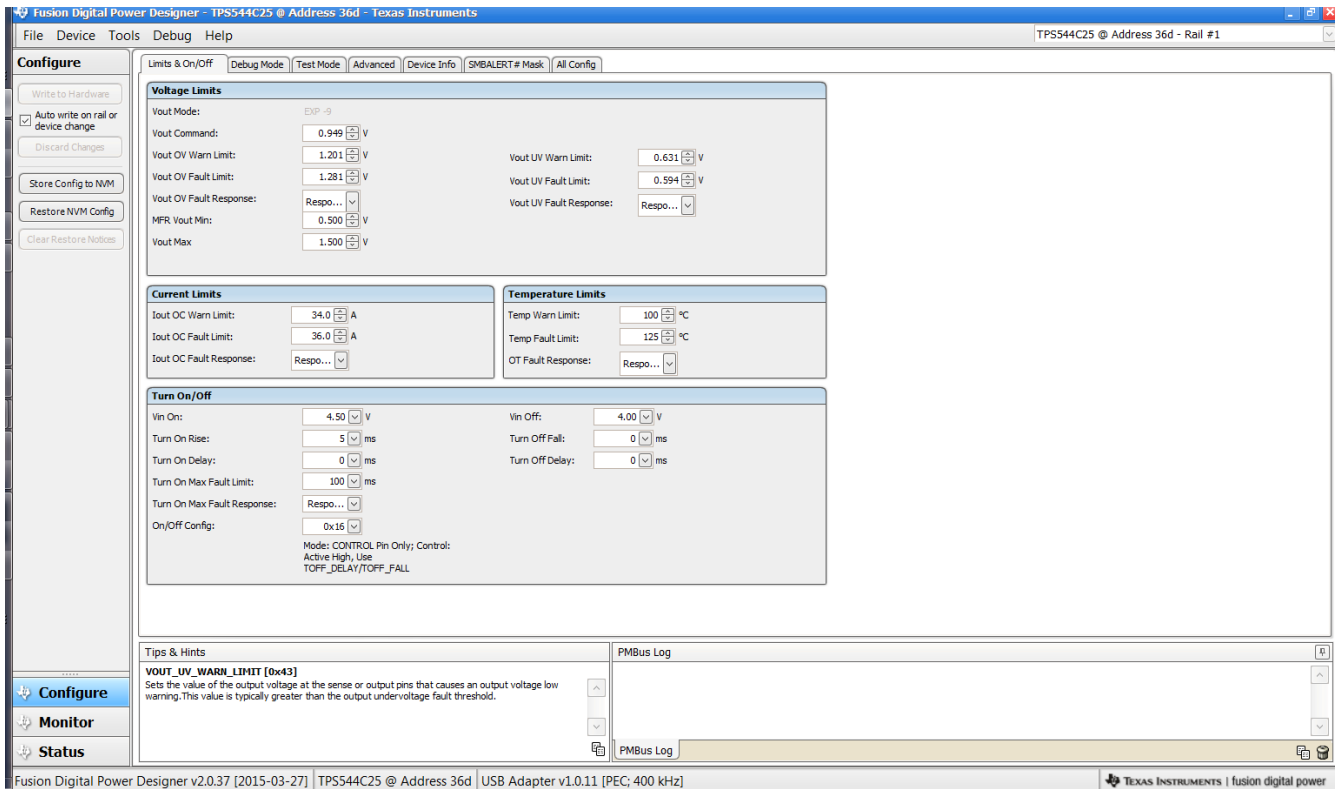

Figure 9-5. First Screen After Successful Launch Configure: Limits and On/Off

Changing the on/off configuration prompts a pop-up window with details of the options [Figure 9-6](#)).

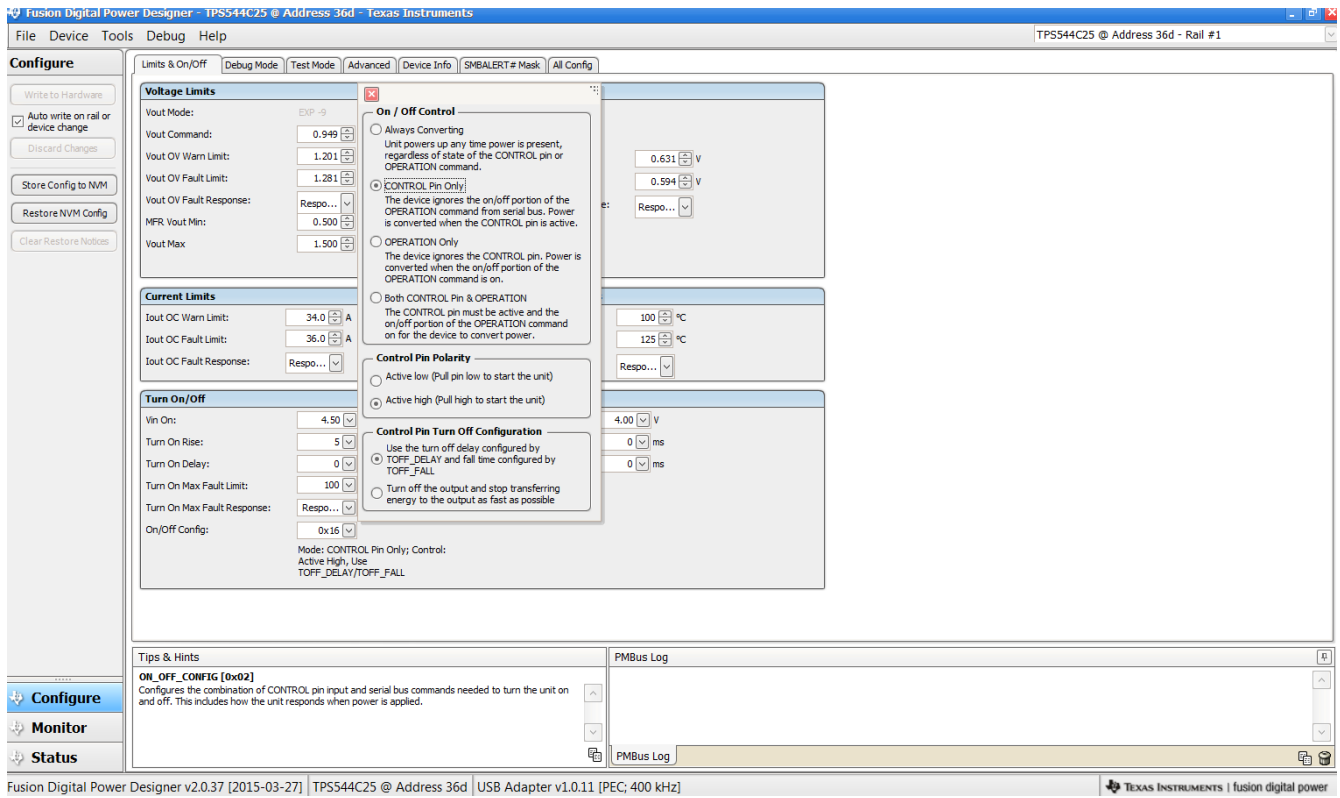

Figure 9-6. Configure: Limits and On/Off- On/Off Configuration Pop-up

After a change is selected, orange **U** icon is displayed to offer *Undo Change* option. Change is not retained until either *Write to Hardware* or *Store Config to NVM* is selected. When *Write to Hardware* is selected, change is committed to volatile memory and defaults back to previous setting on input power cycle. When *Store Config to NVM* is selected, change is committed to nonvolatile memory and becomes the new default (Figure 9-7).

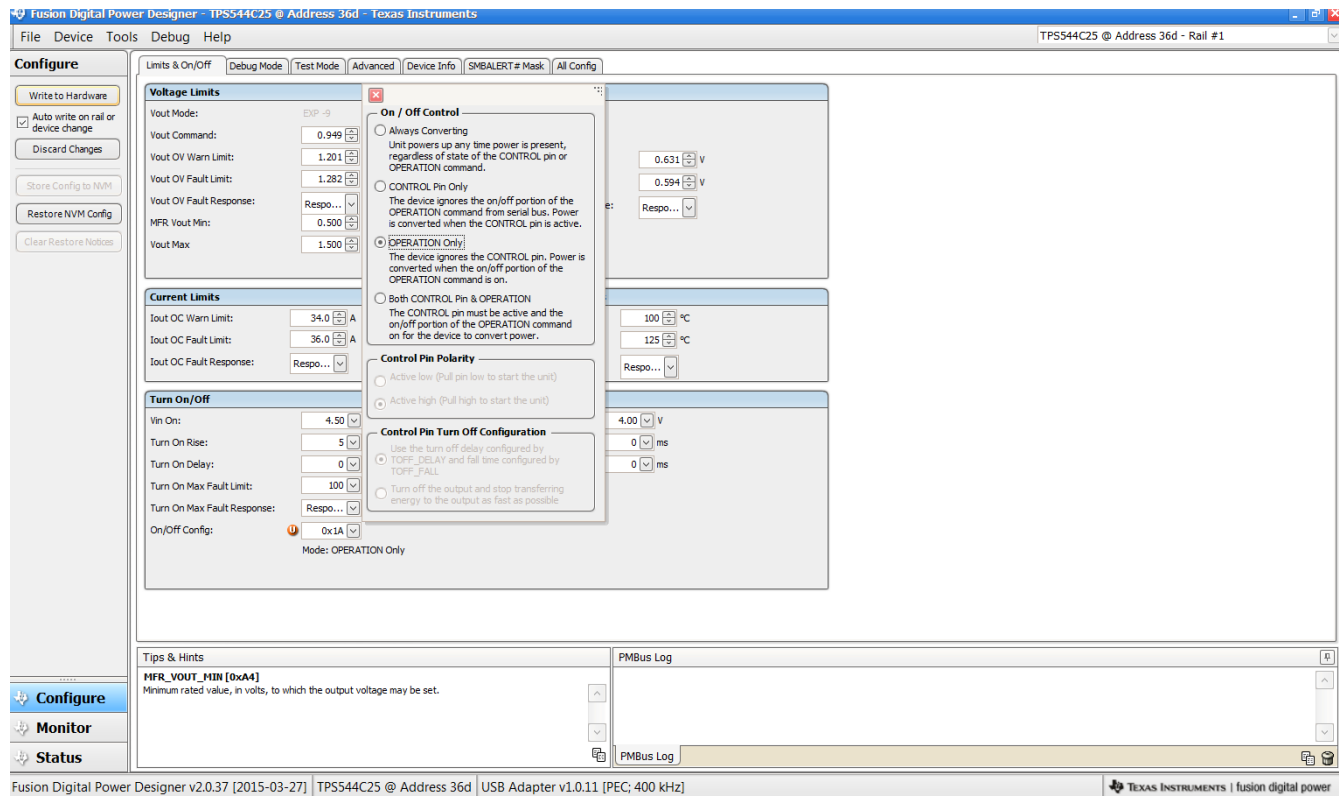

Figure 9-7. Configure: Limits and On/Off- On/Off Config Pop-Up with Change

Use "Advanced" tag to configure (Figure 9-8) :

- E5h OPTIONS (MFR_SPECIFIC_21)
- F0h MISC_CONFIG_OPTIONS options (MFR_SPECIFIC_32)

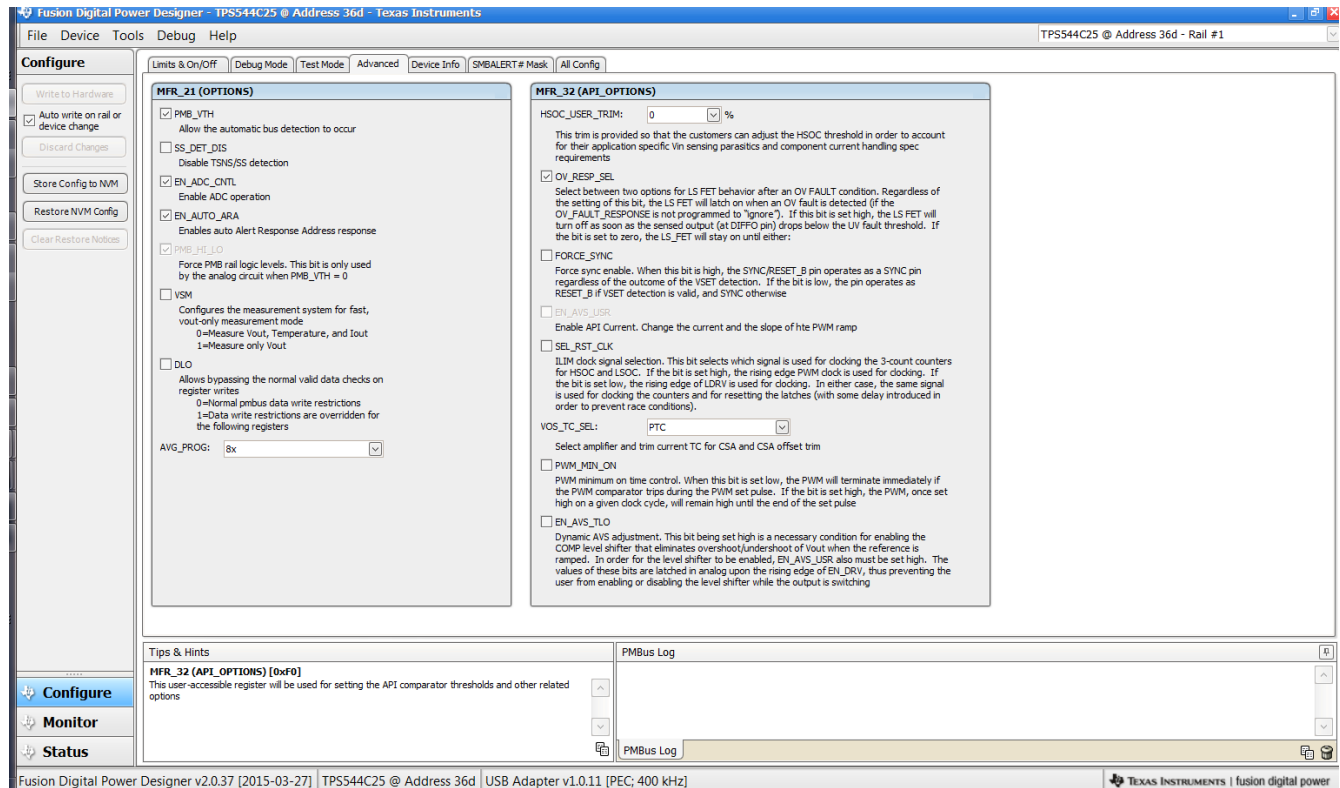

Figure 9-8. Configure: Advanced

The device information, User Scratch Pad, Write Protection options, the configuration of Vout Scale loop, Vout Transition Rate and Iout Offset can be found on "Device Info" tag (Figure 9-9). The I_{OUT} offset can be typed in or scrolled to a new value. The range for I_{OUT} cal offset is -4 A to 3.9375 A and the resolution step is 62.5 mA. If a value is typed in that is between the available discrete steps, the typed-in value does not change but the nearest discrete step is retained. The actual step is displayed on relaunch of the Fusion GUI.

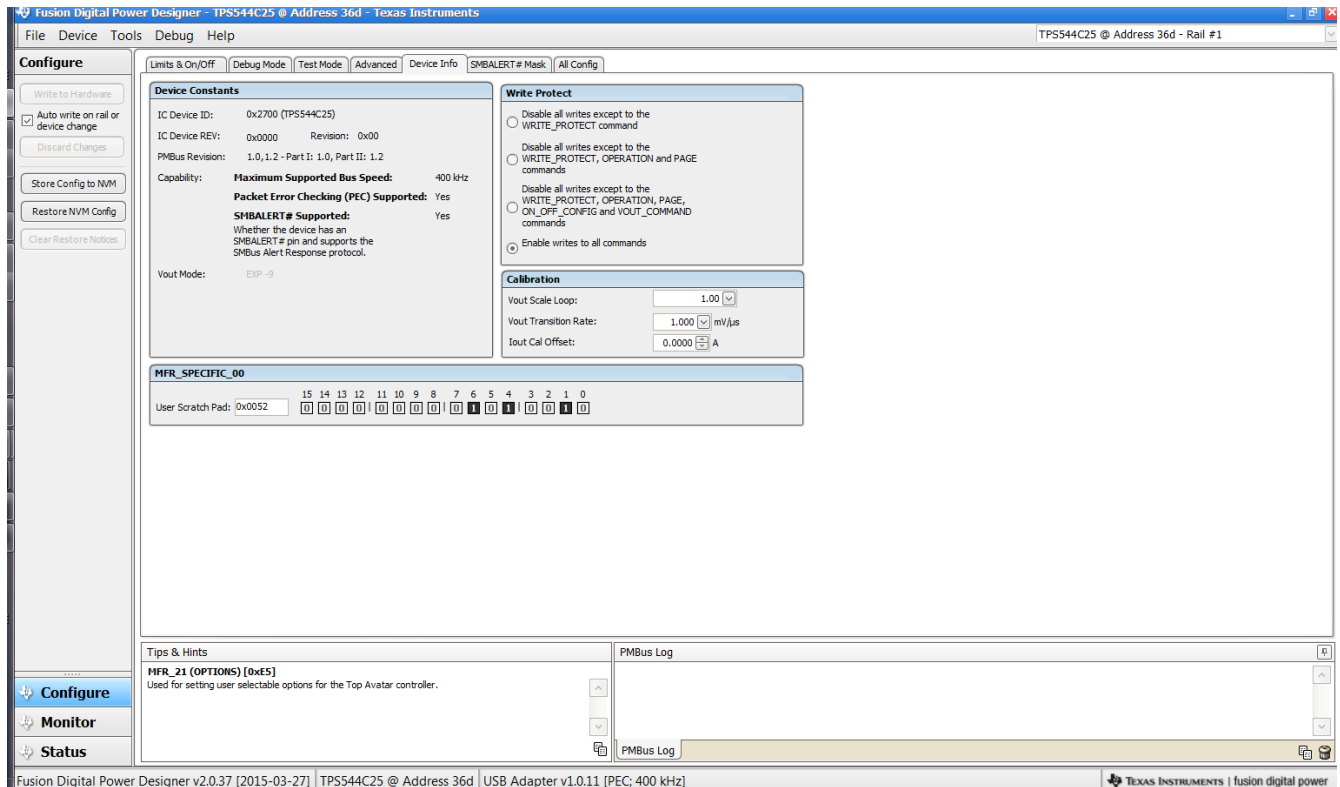

Figure 9-9. Configure: Device Info

The sources of SMBALERT which can be masked can be found and configured on the "SMBALERT # Mast" screen (Figure 9-10)

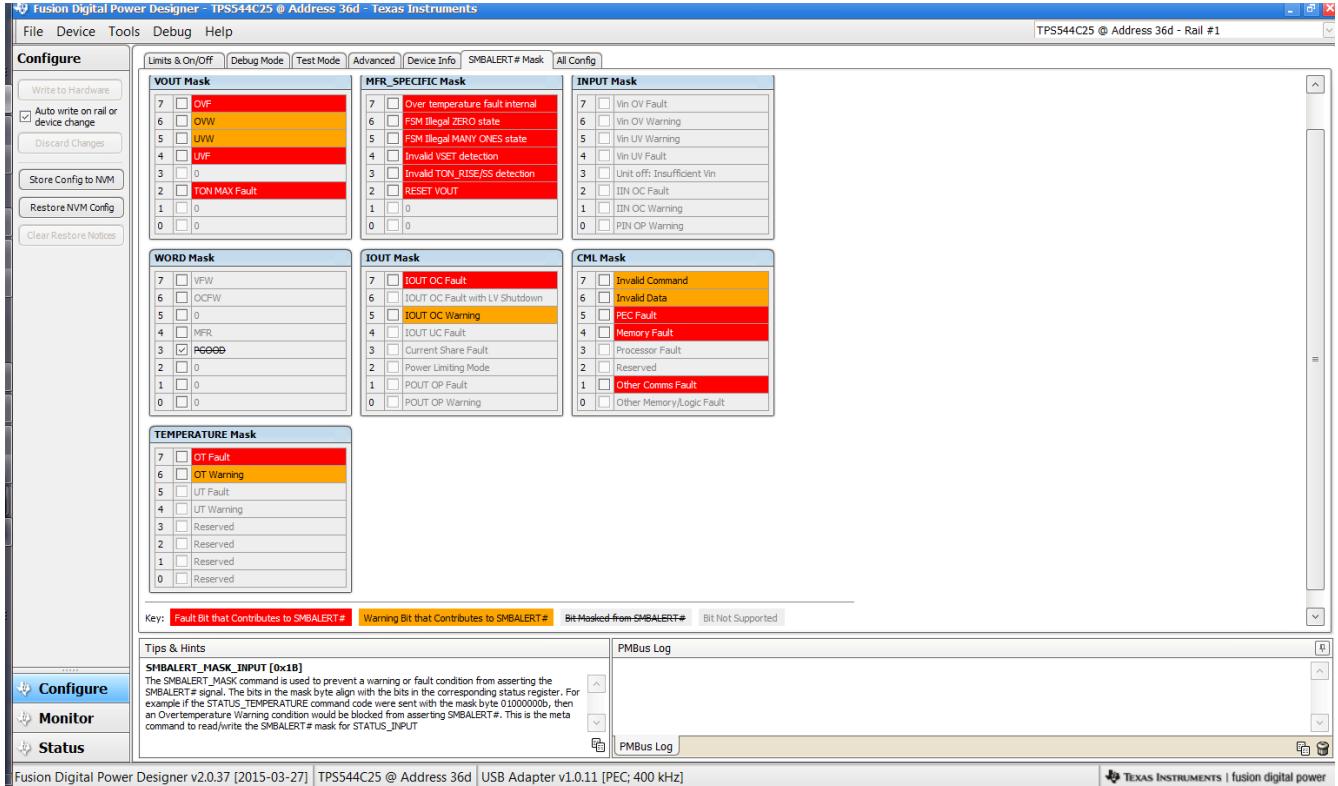
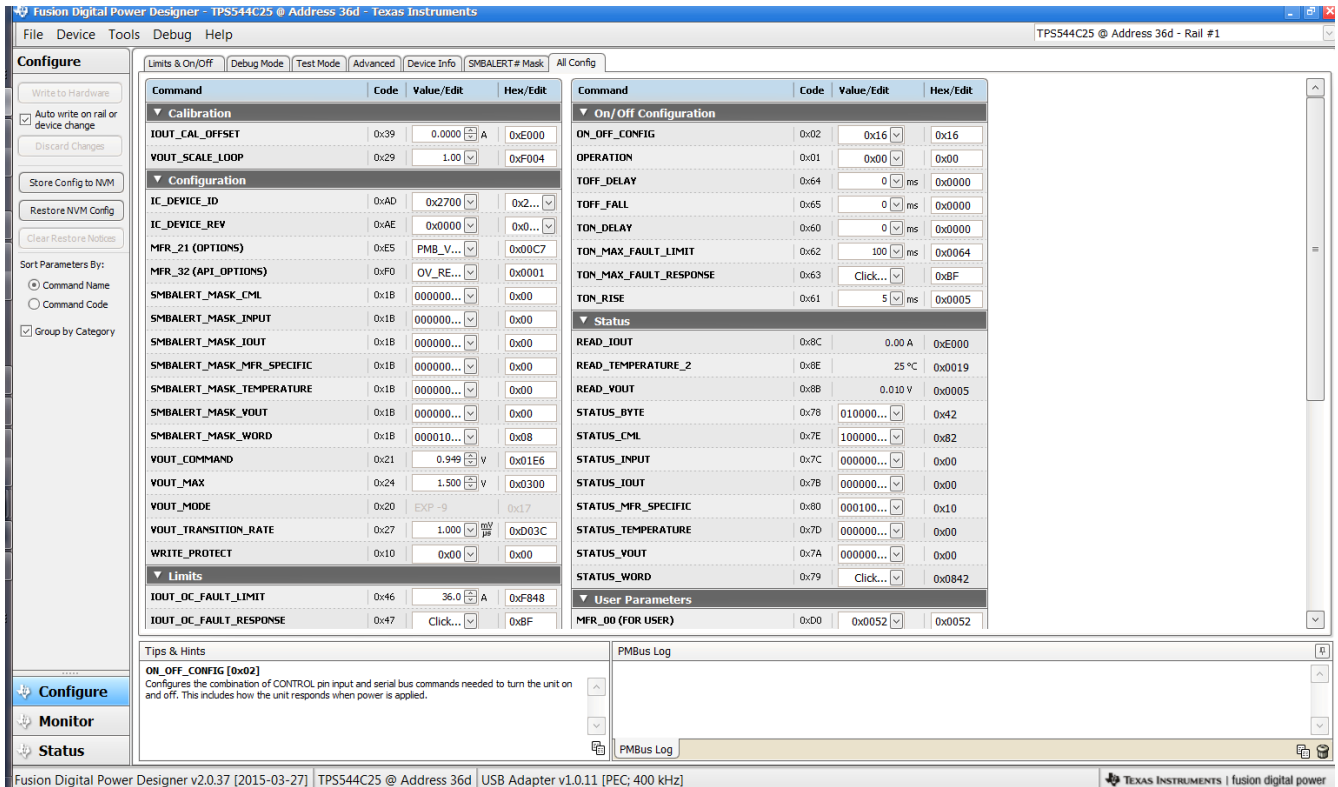

Figure 9-10. Configure: SMBALERT # Mask

Use "All Config" tag to configure all of the configurable parameters (Figure 9-11). The screen also shows other details like hexadecimal (hex) encoding.



The screenshot displays the 'All Config' tab in the Fusion Digital Power Designer software. The interface is divided into several sections:

- Left Panel:** Contains navigation buttons for 'Configure', 'Monitor', and 'Status'. It also includes options like 'Write to Hardware', 'Auto write on rail or device change', and 'Store Config to NVM'.
- Top Menu:** Includes 'File', 'Device', 'Tools', 'Debug', and 'Help'. The current device is identified as 'TPS544C25 @ Address 36d - Rail #1'.
- Main Configuration Area:** A large table with columns for 'Command', 'Code', 'Value/Edit', and 'Hex/Edit'. It is organized into several expandable sections:
 - Calibration:** Parameters like IOUT_CAL_OFFSET (0x39) and VOUT_SCALE_LOOP (0x29).
 - Configuration:** Parameters like IC_DEVICE_ID (0xAD), MFR_21 (0xE5), and VOUT_MAX (0x24).
 - Limits:** Parameters like IOUT_OC_FAULT_LIMIT (0x46) and IOUT_OC_FAULT_RESPONSE (0x47).
 - On/Off Configuration:** Parameters like ON_OFF_CONFIG (0x02), TOFF_DELAY (0x64), and TON_DELAY (0x60).
 - Status:** Parameters like READ_IOUT (0x8C), READ_TEMPERATURE_2 (0x8E), and STATUS_BYTE (0x78).
 - User Parameters:** Parameter MFR_00 (FOR USER) (0xD0).
- Bottom Panel:** Includes 'Tips & Hints' (e.g., ON_OFF_CONFIG [0x02] description) and a 'PMBus Log' area.
- Footer:** Shows the software version 'Fusion Digital Power Designer v2.0.37 [2015-03-27]' and hardware details like 'TPS544C25 @ Address 36d' and 'USB Adapter v1.0.11 [PEC; 400 kHz]'.

Figure 9-11. Configure: All

On/Off configuration can also be configured from the "All Config" screens, and the same process applies (Figure 9-12).

The screenshot shows the Fusion Digital Power Designer software interface. The main window is titled "TPS544C25 @ Address 36d - Rail #1". The "Configure" tab is active, and the "All Config" sub-tab is selected. The interface is divided into several sections:

- Left Sidebar:** Contains buttons for "Write to Hardware", "Auto write on rail or device change", "Discard Changes", "Store Config to NVM", "Restore NVM Config", "Clear Restore Notices", and "Sort Parameters By: Command Name, Command Code, Group by Category".
- Calibration Table:**

Command	Code	Value/Edit	Hex/Edit
IOUT_CAL_OFFSET	0x39	0.0000 A	0xE000
VOUT_SCALE_LOOP	0x29	1.00	0xF004
- Configuration Table:**

Command	Code	Value/Edit	Hex/Edit
IC_DEVICE_ID	0xAD	0x2700	0x2...
IC_DEVICE_REV	0xAE	0x0000	0x0...
MFR_21 (OPTIONS)	0xE5	FMB_V...	0x00C7
MFR_32 (APL_OPTIONS)	0xF0	OV_RE...	0x0001
SMBALERT_MASK_CML	0x1B	000000...	0x00
SMBALERT_MASK_INPUT	0x1B	000000...	0x00
SMBALERT_MASK_IOUT	0x1B	000000...	0x00
SMBALERT_MASK_MFR_SPECIFIC	0x1B	000000...	0x00
SMBALERT_MASK_TEMPERATURE	0x1B	000000...	0x00
SMBALERT_MASK_VOUT	0x1B	000000...	0x00
SMBALERT_MASK_WORD	0x1B	000010...	0x08
VOUT_COMMAND	0x21	0.949 V	0x01E6
VOUT_MAX	0x24	1.500 V	0x0300
VOUT_MODE	0x20	EXP -9	0x17
VOUT_TRANSITION_RATE	0x27	1.000 mV	0xD03C
WRITE_PROTECT	0x10	0x00	0x00
- Limits Table:**

Command	Code	Value/Edit	Hex/Edit
IOUT_OC_FAULT_LIMIT	0x46	36.0 A	0xF848
IOUT_OC_FAULT_RESPONSE	0x47	Click...	0x8F
- On/Off Configuration Table:**

Command	Code	Value/Edit	Hex/Edit
ON_OFF_CONFIG	0x02	0x1A	0x1A
OPERATION	0x01	0x00	0x00
TOFF_DELAY	0x64	0	0
TOFF_FALL	0x65	0	0
TON_DELAY	0x60	0	0
TON_MAX_FAULT_LIMIT	0x62	100	100
TON_MAX_FAULT_RESPONSE	0x63	Click...	Click...
TON_RISE	0x61	5	5
- Status Table:**

Command	Code	Value/Edit	Hex/Edit
READ_IOUT	0x8C	0.00	0.00
READ_TEMPERATURE_2	0x8E	25	25
READ_VOUT	0x88	0.010	0.010
STATUS_BYTE	0x78	010000...	010000...
STATUS_CML	0x7E	100000...	100000...
STATUS_INPUT	0x7C	000000...	000000...
STATUS_IOUT	0x7B	000000...	000000...
STATUS_MFR_SPECIFIC	0x80	000100...	000100...
STATUS_TEMPERATURE	0x7D	000000...	000000...
STATUS_VOUT	0x7A	000000...	000000...
STATUS_WORD	0x79	Click...	Click...
- On / Off Control Pop-up:**
 - Always Converting:** Unit powers up any time power is present, regardless of state of the CONTROL pin or OPERATION command.
 - CONTROL Pin Only:** The device ignores the on/off portion of the OPERATION command from serial bus. Power is converted when the CONTROL pin is active.
 - OPERATION Only:** The device ignores the CONTROL pin. Power is converted when the on/off portion of the OPERATION command is on.
 - Both CONTROL Pin & OPERATION:** The CONTROL pin must be active and the on/off portion of the OPERATION command on for the device to convert power.
 - Control Pin Polarity:**
 - Active low (Pull pin low to start the unit)
 - Active high (Pull high to start the unit)
 - Control Pin Turn Off Configuration:**
 - Use the turn off delay configured by TOFF_DELAY and fall time configured by TOFF_FALL
 - Turn off the output and stop transferring energy to the output as fast as possible
- Bottom Panel:** Includes "Tips & Hints" for ON_OFF_CONFIG [0x02], "PMBus Log", and "Fusion Digital Power Designer v2.0.37 [2015-03-27] TPS544C25 @ Address 36d | USB Adapter v1.0.11 [PEC; 400 kHz]".

Figure 9-12. Configure: All Config- On/Off Config Pop-up

After making changes to one or more configurable parameters, the changes can be committed to nonvolatile memory by selecting *Store Config to NVM*. This action prompts a *confirm selection* pop-up, and if confirmed, the changes are committed to nonvolatile memory (Figure 9-13).

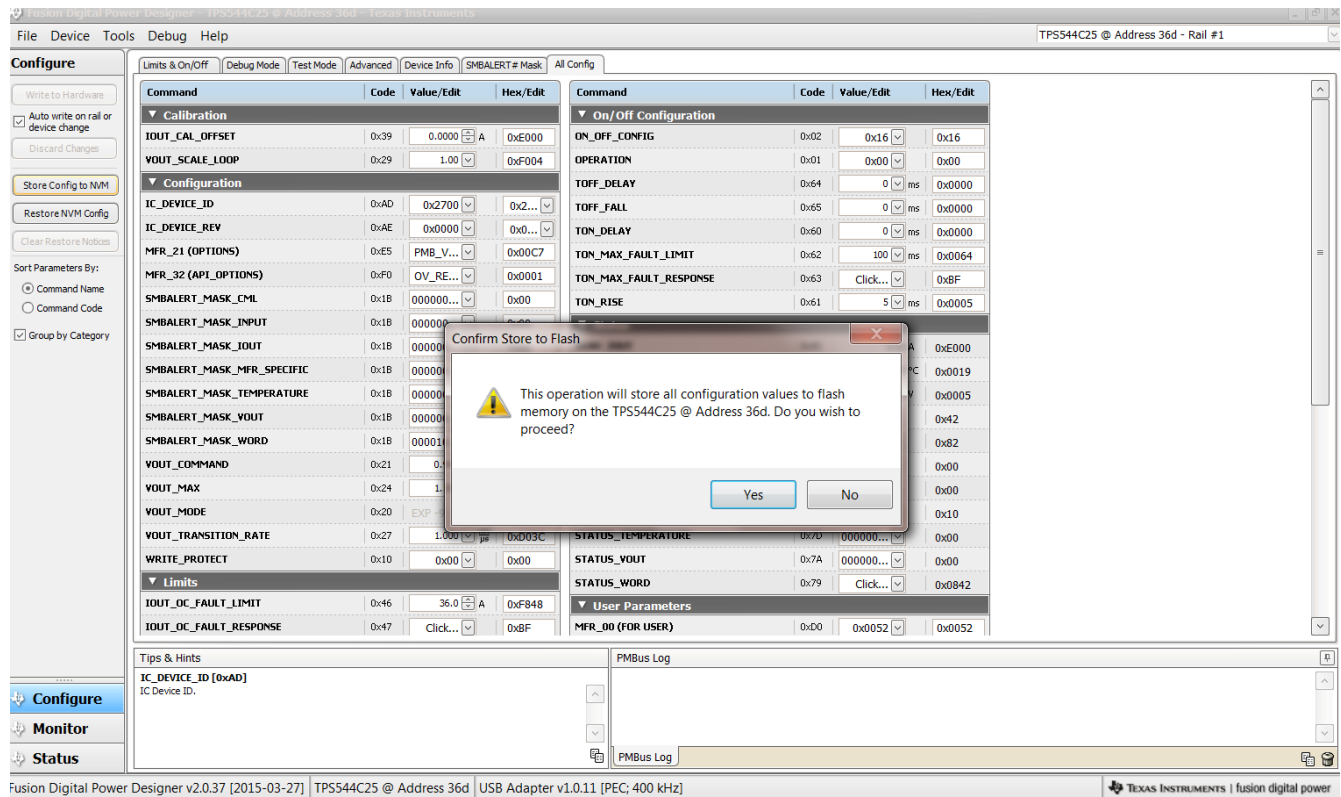

Figure 9-13. Configure: Store Config to NVM

In the lower left corner, the different view screens can be changed. The view screens can be changed between *Configure*, *Monitor* and *Status* as needed (Figure 9-14).

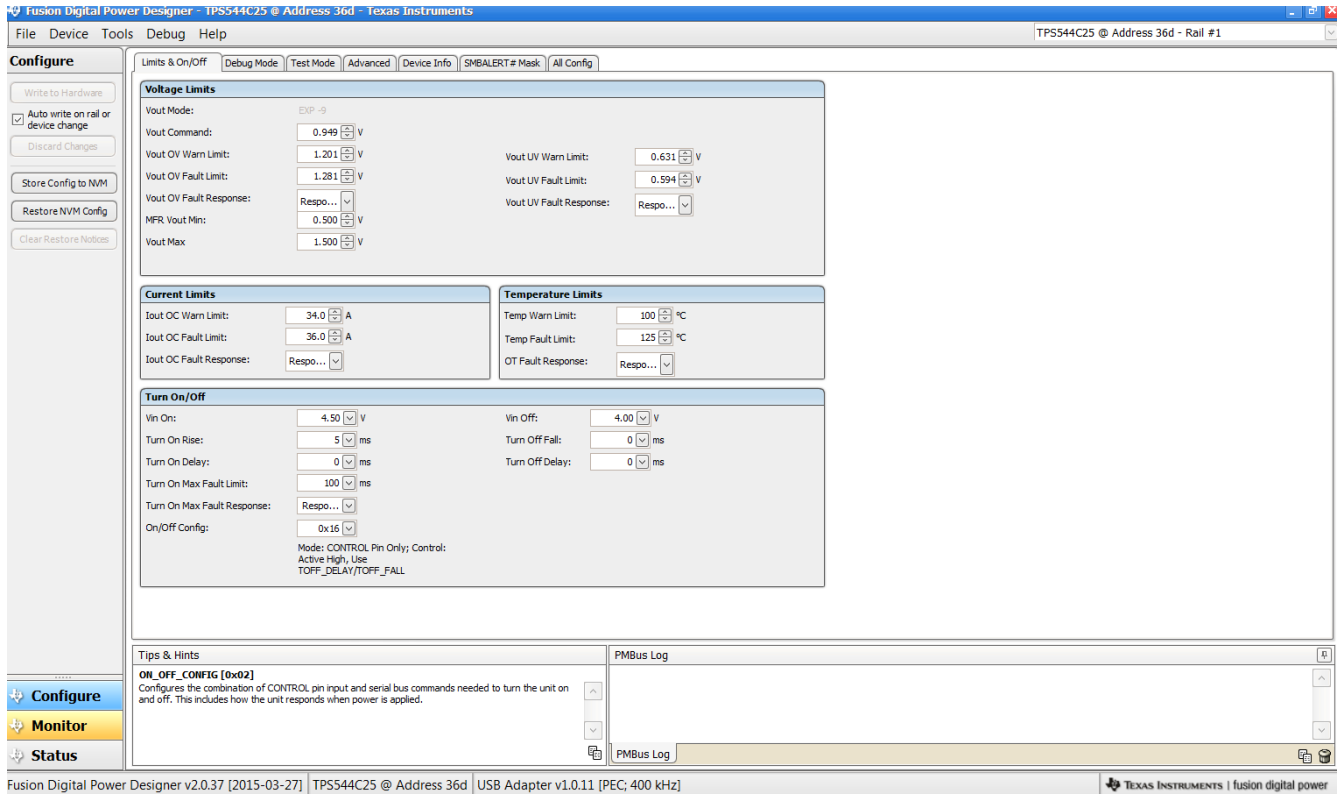

Figure 9-14. Change View Screen to Monitor Screen

When the *Monitor* screen is selected (Figure 9-15), the screen changes to display real-time data of the parameters that are measured by the controller. This screen provides access to:

- Graphs of V_{OUT} , I_{OUT} , and *Temperature*. As shown, Pout display is turned off.
- *Start/Stop polling* which turns on or off the real-time display of data.
- *Clear Faults* to clear any prior fault flags
- Quick access to on/off configuration
- Control pin activation, and operation command.
- PMBus log which displays activity on the PMBus.
- *Tips and hints* which displays additional information when the cursor is hovered over configurable parameters.

At first GUI launch, faults may occur due to communications during power up. These faults can be cleared once the device is enabled.



Figure 9-15. Monitor Screen

Selecting *System Dashboard* from mid-left screen adds a new window which displays system-level information (Figure 9-16).

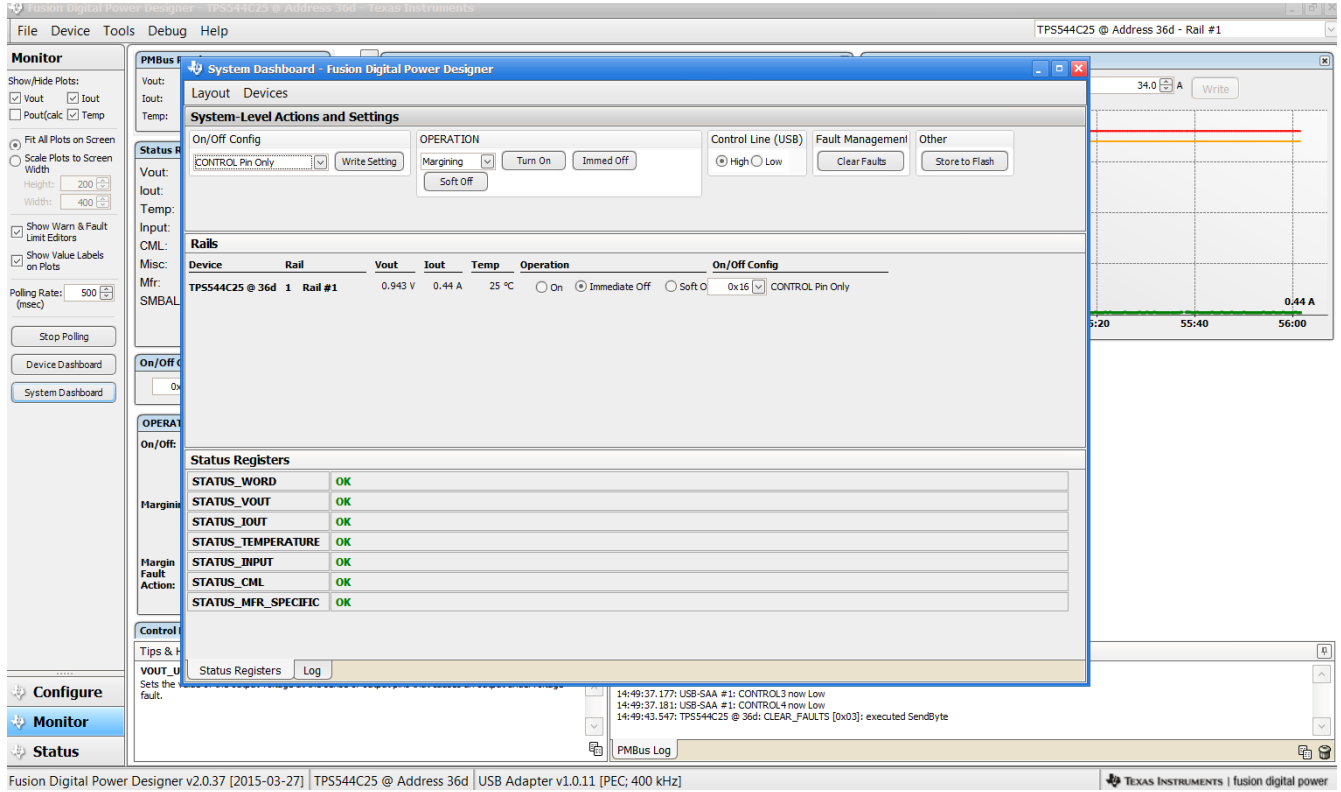

Figure 9-16. System Dashboard

Selecting *Status* from lower left corner shows the status of the controller (Figure 9-17).

The screenshot shows the 'Status' screen in the Fusion Digital Power Designer software. The interface includes a menu bar (File, Device, Tools, Debug, Help), a toolbar (Stop Polling, Launch Dashboard, Clear Faults), and a main display area with several status registers. A legend at the bottom indicates that red boxes represent 'Fault', yellow boxes represent 'Warning', and blue boxes represent 'See other register'. The status registers are:

- STATUS_WOUT**: 7 OV, 6 OVW, 5 UVW, 4 UVF, 3 0, 2 TON MAX Fault, 1 0, 0 0.
- STATUS_IOUT**: 7 IOUT OC Fault, 6 IOUT OC Fault with LV Shutdown, 5 IOUT OC Warning, 4 IOUT UC Fault, 3 Current Share Fault, 2 Power Limiting Mode, 1 POUT OP Fault, 0 POUT OP Warning.
- STATUS_TEMP**: 7 OT Fault, 6 OT Warning, 5 UT Fault, 4 UT Warning, 3 Reserved, 2 Reserved, 1 Reserved, 0 Reserved.
- STATUS_WORD**: 15 VFW, 14 OCFW, 13 INPUT, 12 Internal Thermal Fault, 11 PGOOD_Z, 10 FANS, 9 OTHER, 8 Unknown, 7 Busy, 6 OFF, 5 OVF, 4 OCF, 3 VIN_UV, 2 OTFW, 1 CML, 0 OTH.
- STATUS_CML**: 7 Invalid Command, 6 Invalid Data, 5 PEC Fault, 4 Memory Fault, 3 Processor Fault, 2 Reserved, 1 Other Comms Fault, 0 Other Memory/Logic Fault.
- STATUS_INPUT**: 7 Vin OV Fault, 6 Vin OV Warning, 5 Vin UV Warning, 4 Vin UV Fault, 3 Unit off: Insufficient Vin, 2 IIN OC Fault, 1 IIN OC Warning, 0 PIN OP Warning.
- STATUS_FANS_1_2**: 7 Fan 1 Fault, 6 Fan 2 Fault, 5 Fan 1 Warning, 4 Fan 2 Warning, 3 Fan 1 Speed Overridden, 2 Fan 2 Speed Overridden, 1 Air Flow Fault, 0 Air Flow Warning.
- STATUS_FANS_3_4**: 7 Fan 3 Fault, 6 Fan 4 Fault, 5 Fan 3 Warning, 4 Fan 4 Warning, 3 Fan 3 Speed Overridden, 2 Fan 4 Speed Overridden, 1 Reserved, 0 Reserved.
- STATUS_MFR_SPECIFIC**: 7 Over temperature fault inten, 6 FSM Illegal ZERO state, 5 FSM Illegal MANY ONES state, 4 Invalid VSET detection, 3 Invalid TON_RISE/SS detectio, 2 RESET VOUT, 1 0, 0 0.
- STATUS_OTHER**: 7 Reserved, 6 Reserved, 5 Input A fuse Or circuit breaker fault, 4 Input B fuse or circuit breaker fault, 3 Input A OR-ing device fault, 2 Input B OR-ing device fault, 1 Output OR-ing device fault, 0 Reserved.

At the bottom of the screen, there is a status bar with the text: 'Fusion Digital Power Designer v2.0.37 [2015-03-27] | TPS544C25 @ Address 36d | USB Adapter v1.0.11 [PEC; 400 kHz] | TEXAS INSTRUMENTS | fusion digital power'.

Figure 9-17. Status Screen

Selecting the pull-down menu *File- Import Project* from the upper left menu bar can be used to configure all parameters in the device at once with a desired configuration, or even revert back to a *known-good* configuration. This action results in a browse-type sequence where the desired configuration file can be located and loaded (Figure 9-18).

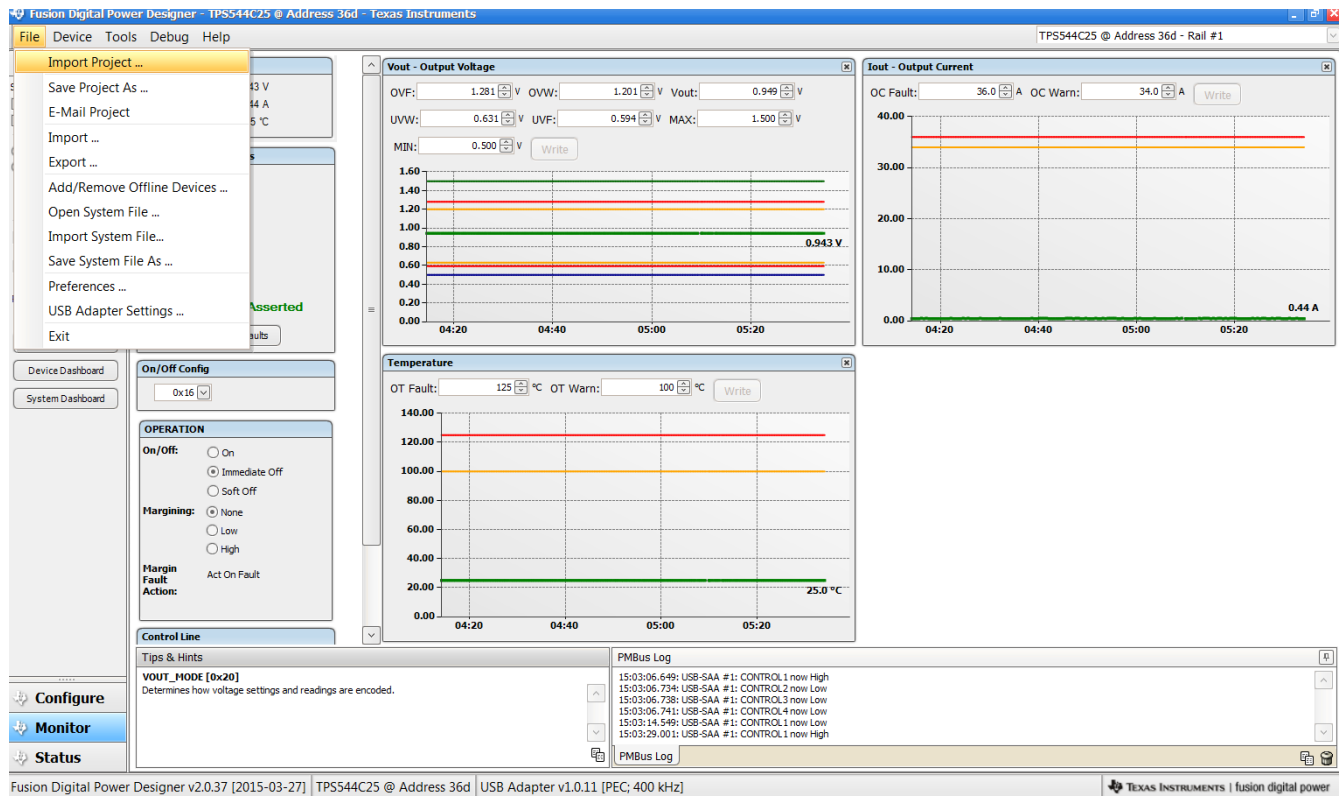

Figure 9-18. Import Project / Import Configuration File

Selecting *Store User Configuration to Flash Memory* from the device pull-down menu has the same functionality as the *Store Config to NVM* button from the configure screen. It results in committing the current configuration to nonvolatile memory (Figure 9-19).

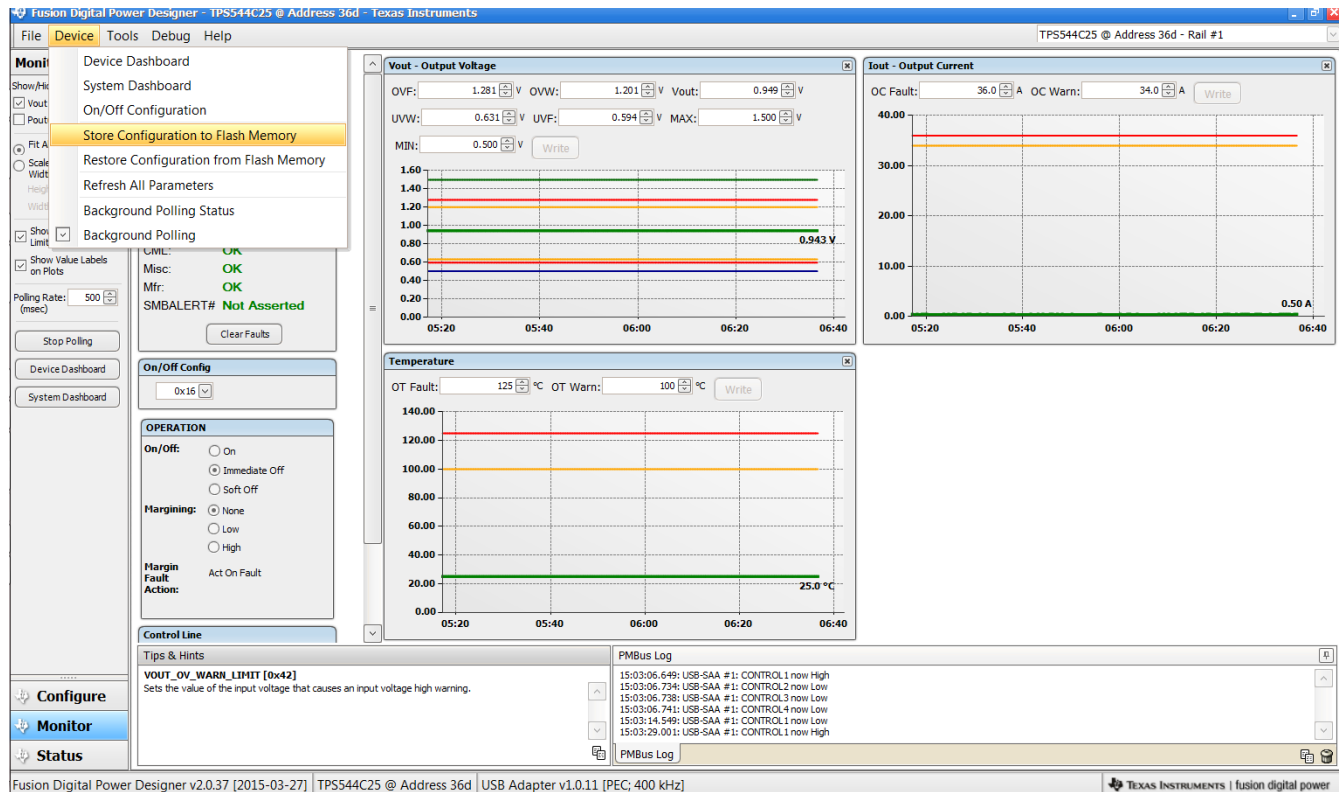

Figure 9-19. Store Configuration To Memory

Select *Data Logging* (Figure 9-20), from the Tools drop-down menu. This enables logging of common operating values such as V_{OUT} , I_{OUT} , and temperature. The user is prompted to select a location for the file to be stored as well as the type of file. Select the storage location for the file and the type of file. Logging begins when the *Start Data Logging* button is selected, and stops when it is reselected.

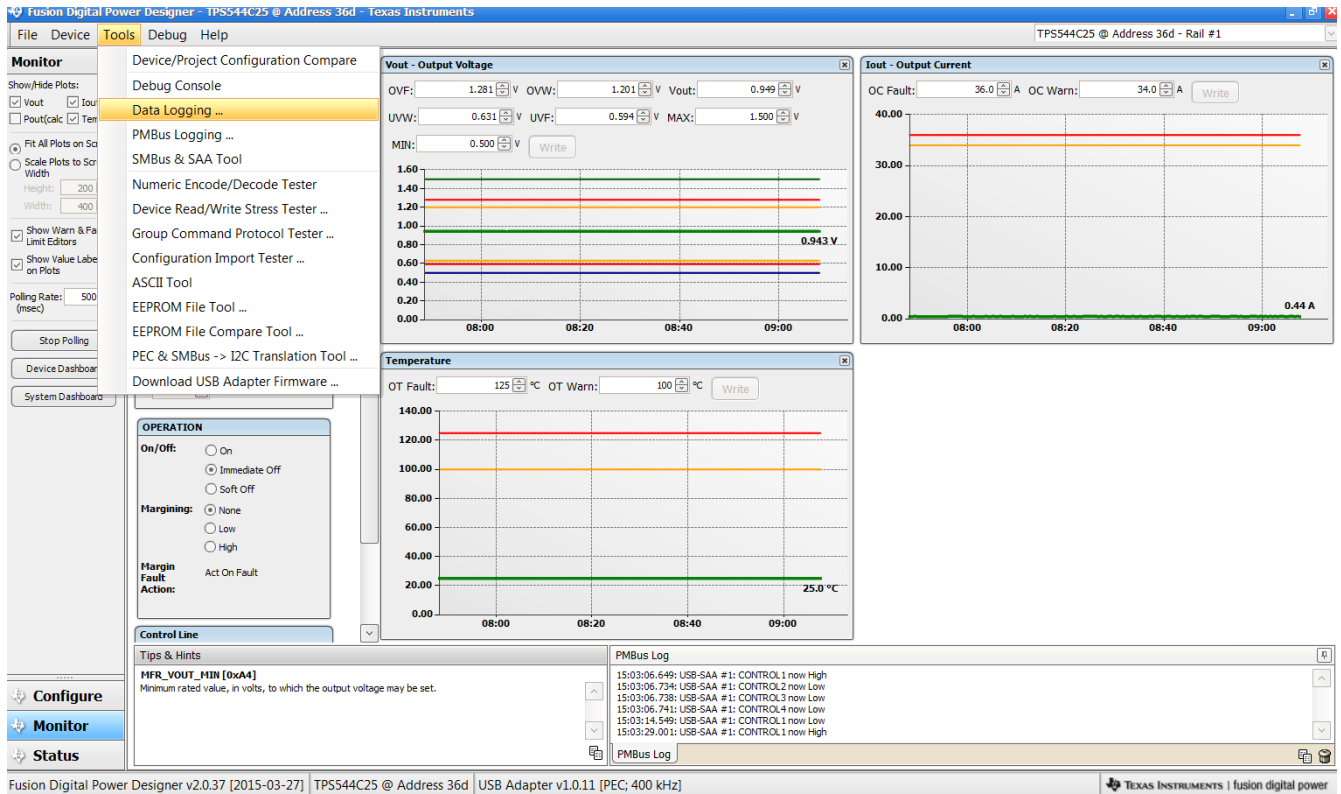
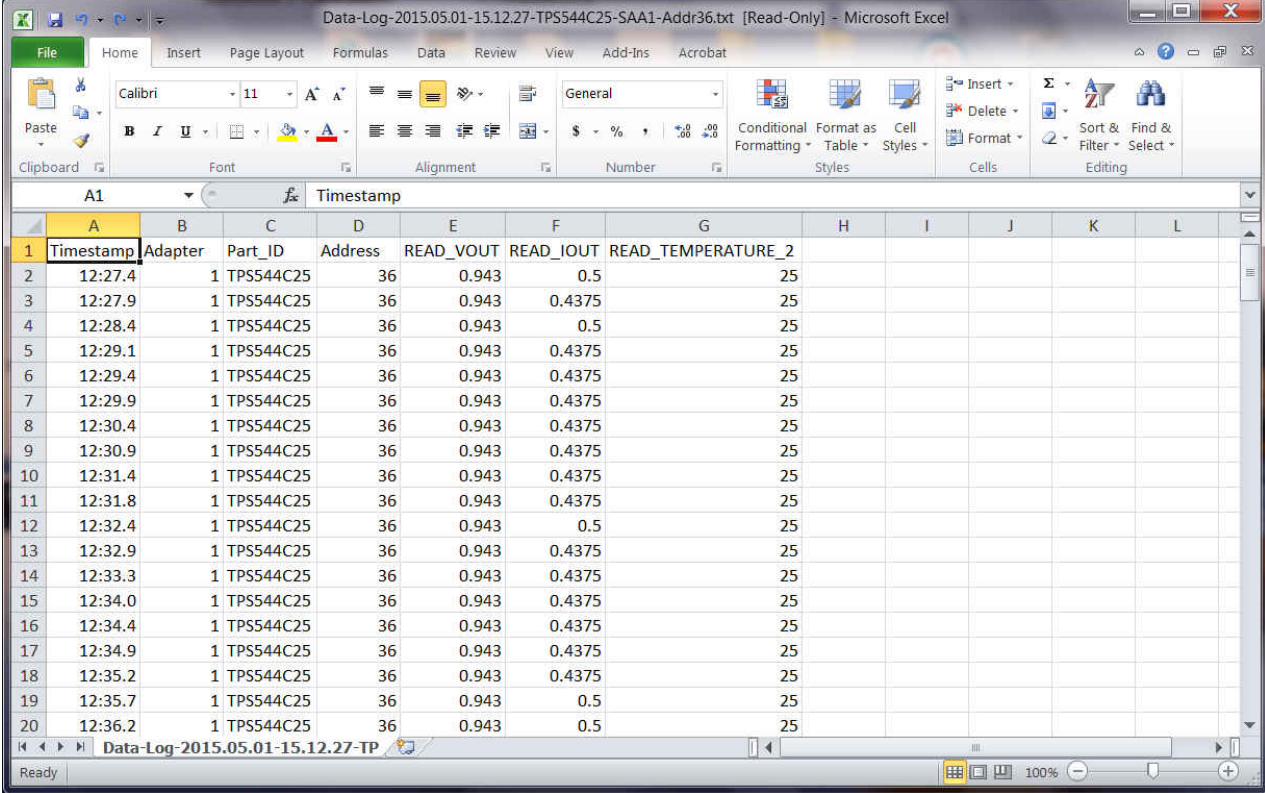

Figure 9-20. Data Logging

Common contents of the data log as shown in (Figure 9-21).



	A	B	C	D	E	F	G	H	I	J	K	L
1	Timestamp	Adapter	Part_ID	Address	READ_VOUT	READ_IOUT	READ_TEMPERATURE_2					
2	12:27.4	1	TPS544C25	36	0.943	0.5	25					
3	12:27.9	1	TPS544C25	36	0.943	0.4375	25					
4	12:28.4	1	TPS544C25	36	0.943	0.5	25					
5	12:29.1	1	TPS544C25	36	0.943	0.4375	25					
6	12:29.4	1	TPS544C25	36	0.943	0.4375	25					
7	12:29.9	1	TPS544C25	36	0.943	0.4375	25					
8	12:30.4	1	TPS544C25	36	0.943	0.4375	25					
9	12:30.9	1	TPS544C25	36	0.943	0.4375	25					
10	12:31.4	1	TPS544C25	36	0.943	0.4375	25					
11	12:31.8	1	TPS544C25	36	0.943	0.4375	25					
12	12:32.4	1	TPS544C25	36	0.943	0.5	25					
13	12:32.9	1	TPS544C25	36	0.943	0.4375	25					
14	12:33.3	1	TPS544C25	36	0.943	0.4375	25					
15	12:34.0	1	TPS544C25	36	0.943	0.4375	25					
16	12:34.4	1	TPS544C25	36	0.943	0.4375	25					
17	12:34.9	1	TPS544C25	36	0.943	0.4375	25					
18	12:35.2	1	TPS544C25	36	0.943	0.4375	25					
19	12:35.7	1	TPS544C25	36	0.943	0.5	25					
20	12:36.2	1	TPS544C25	36	0.943	0.5	25					

Figure 9-21. Data Log File

Selecting *PMBus Logging* (Figure 9-22) from the Tools drop-down menu enables the logging of all PMBus activity in the same way as the datalogging. This includes communications traffic for each polling loop between the GUI and the device. It also includes common operating values such as V_{OUT} , I_{OUT} , and temperature. The user is prompted to select a location for the file to be stored. See next screen (Figure 9-23).

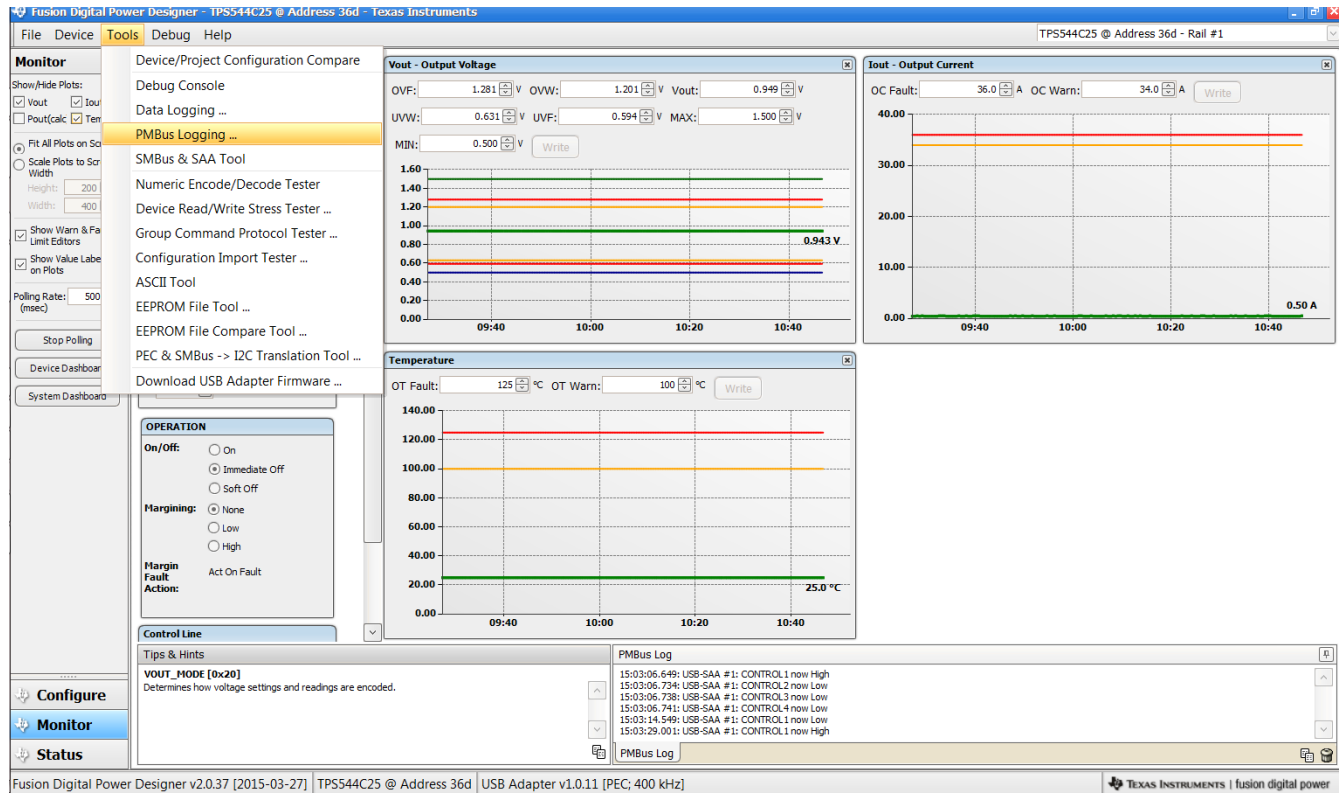

Figure 9-22. PMBus Logging

Select the storage location for the file and the type of file. As shown (Figure 9-23), the file is a CSV file to be stored in the directory path shown. Logging begins when the *Start Logging* button is selected, and stops when it is reselected (as *Stop Logging*). This file can rapidly grow in size, so caution is advised when using this function.

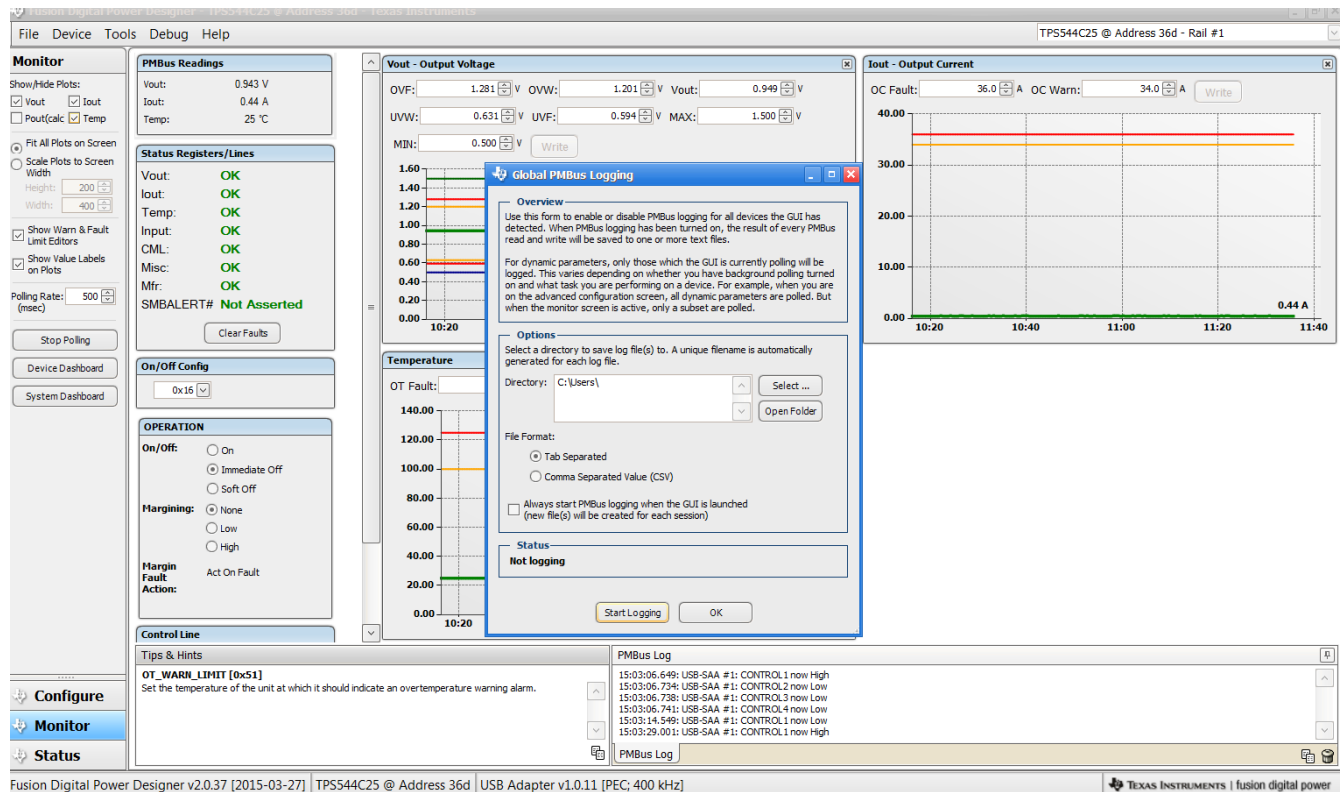
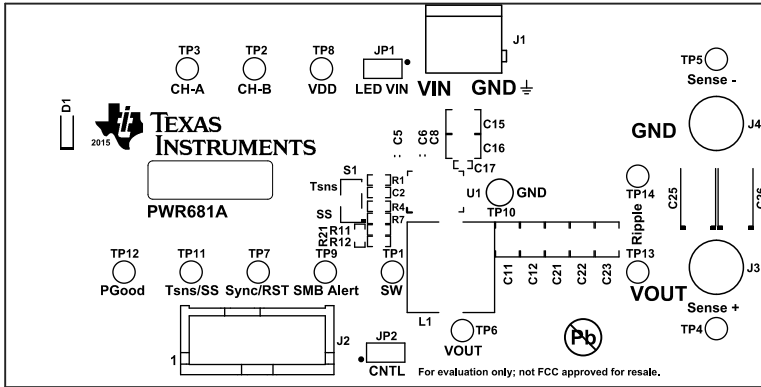

Figure 9-23. PMBus Log Details

10 EVM Assembly Drawing and PCB Layout

Figure 10-1 through Figure 10-6 show the design of the PWR-681EVM printed-circuit board (PCB).



ALL ARTWORK VIEWED FROM TOP SIDE	BOARD #: PWR681	REV: A	SUN REV: Not In VersionControl
LAYER NAME = Top Overlay			
PLOT NAME = Top Overlay	GENERATED : 3/30/2015 11:10:41 AM	TEXAS INSTRUMENTS	

Figure 10-1. PWR-681EVM Top Layer Assembly Drawing (top view)

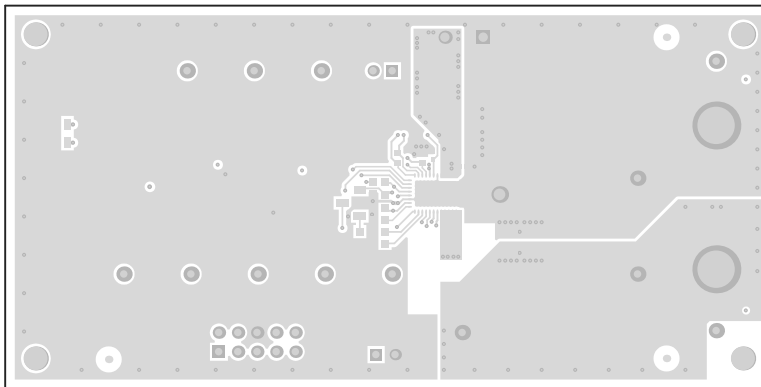

ALL ARTWORK VIEWED FROM TOP SIDE	BOARD #: PWR681	REV: A	SUN REV: Not In VersionControl
LAYER NAME = Top Layer			
PLOT NAME = Top Layer	GENERATED : 3/30/2015 11:10:42 AM	TEXAS INSTRUMENTS	

Figure 10-2. PWR-681EVM Top Layer (top view)

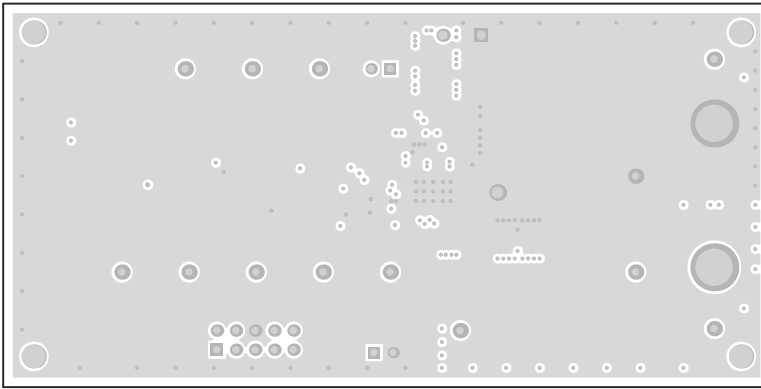

ALL ARTWORK VIEWED FROM TOP SIDE	BOARD #: PWR681	REV: A	SUN REV: Not In VersionControl
LAYER NAME = MidLayer1			
PLOT NAME = Inner Layer 1	GENERATED : 3/30/2015 11:10:42 AM	TEXAS INSTRUMENTS	

Figure 10-3. PWR-681EVM Layer 1 (top view)

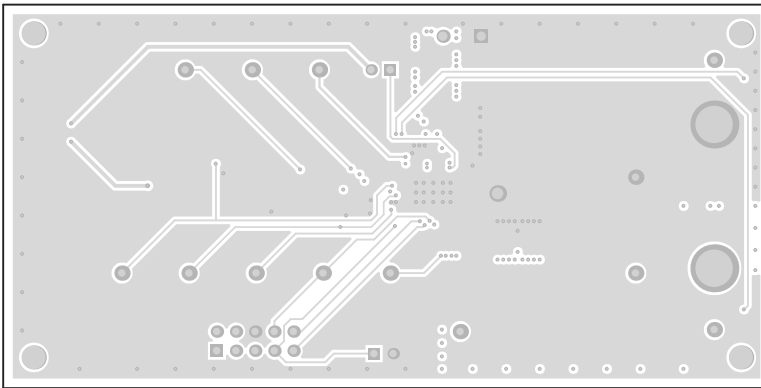

ALL ARTWORK VIEWED FROM TOP SIDE	BOARD #: PWR681	REV: A	SUN REV: Not In VersionControl
LAYER NAME = MidLayer2			
PLOT NAME = Inner Layer 2	GENERATED : 3/30/2015 11:10:43 AM	TEXAS INSTRUMENTS	

Figure 10-4. PWR-681EVM Layer 2 (top view)

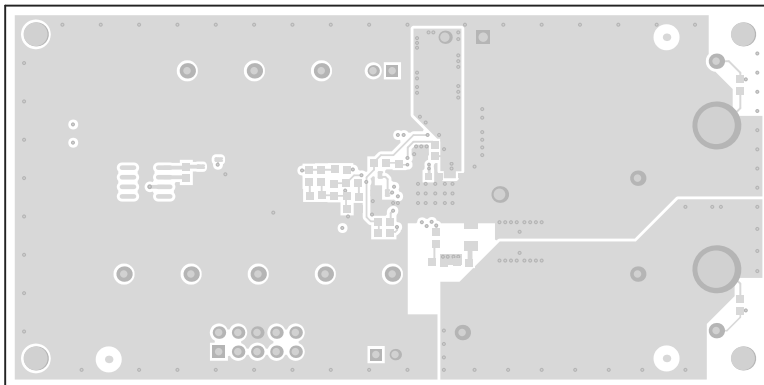

ALL ARTWORK VIEWED FROM TOP SIDE	BOARD #: PWR681	REV: A	SUN REV: Not In VersionControl
LAYER NAME = Bottom Layer			
PLOT NAME = Bottom Layer	GENERATED : 3/30/2015 11:10:43 AM	TEXAS INSTRUMENTS	

Figure 10-5. PWR-681EVM Bottom Layer (top view)

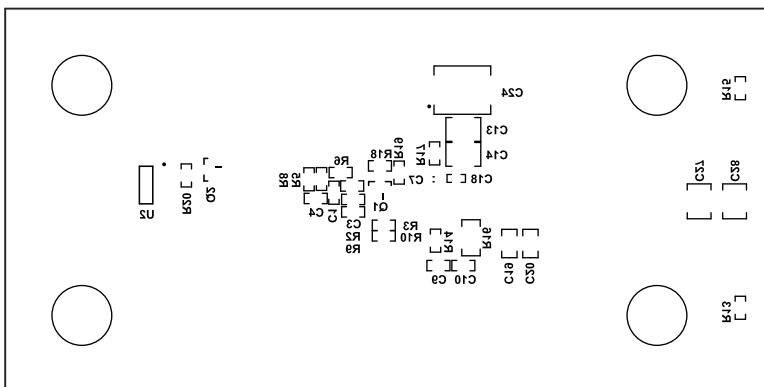

ALL ARTWORK VIEWED FROM TOP SIDE	BOARD #: PWR681	REV: A	SUN REV: Not In VersionControl
LAYER NAME = Bottom Overlay			
PLOT NAME = Bottom Overlay	GENERATED : 3/30/2015 11:10:44 AM	TEXAS INSTRUMENTS	

Figure 10-6. PWR-681EVM Bottom Layer Assembly Drawing (top view)

11 List of Materials

The EVM components list according to the schematic shown in [Table 11-1](#).

Note

TPS544C25 version used for this example. The TPS544B25 EVM has the same List of Material as the TPS544C25 EVM with the exception of U1.

Table 11-1. PWR681 List of Materials

QTY	DES	DESCRIPTION	MANUFACTURER	PART NUMBER
1	PCB	Printed Circuit Board	Any	PWR681
1	C1	Capacitor, ceramic, 33 pF, 100 V, ±5%, C0G/NP0, 0603	AVX	06031A330JAT2A
2	C2, C10	Capacitor, ceramic, 1000 pF, 100 V, ±5%, X7R, 0603	AVX	06031C102JAT2A
2	C3, C4	Capacitor, ceramic, 1200 pF, 50 V, ±5%, C0G/NP0, 0603	TDK	C1608C0G1H122J
1	C5	Capacitor, ceramic, 330 pF, 50 V, ±1%, C0G/NP0, 0603	TDK	C1608C0G1H331F080A A
1	C6	Capacitor, ceramic, 1 µF, 25 V, ±10%, X7R, 0603	MuRata	GRM188R71E105KA12D
1	C7	Capacitor, ceramic, 4.7 µF, 10 V, ±10%, X5R, 0603	Kemet	C0603C475K8PACTU
1	C8	Capacitor, ceramic, 2.2 µF, 6.3 V, ±10%, X6S, 0402	MuRata	GRM155C80J225KE95D
1	C9	Capacitor, ceramic, 0.1 µF, 25 V, ±5%, X7R, 0603	Kemet	C0603C104J3RACTU
7	C11, C12, C21, C22, C23, C27, C28	Multi-layer ceramic capacitor, 100 µF, 6.3 V, X5R, 1210	Würth	885012109004
4	C13, C14, C15, C16	Multi-layer ceramic capacitor, 22 µF, 25 V, X5R, 1210	Würth	885012109014
2	C17, C18	Capacitor, ceramic, 6800 pF, 25 V, ±10%, X7R, 0402	MuRata	GRM155R71E682KA01D
2	C19, C20	Capacitor, ceramic, 22 µF, 6.3 V, ±20%, X5R, 0805	MuRata	GRM21BR60J226ME39L
1	C24	Capacitor, TA, 100 µF, 25 V, ±10%, 0.1 Ω, SMD	AVX	TPSV107K025R0100
1	D1	LED, pink, SMD	Bivar	SMS1105PKD
4	H1, H2, H3, H4	Bumpon, cylindrical, 0.312 X 0.200, black	3M	SJ61A1
2	H5, H6	Screw, 6-32 x 3/8" steel	B&F Fastener Supply	PMSSS 632 0038 PH
1	J1	2-pin terminal block, 0.200" spacing	Würth	691216510002
1	J2	10-pin header, 2x5, 0.100" spacing, shrouded	Würth	61201021621
2	J3, J4	Swage threaded standoff, brass, swage mount, TH	Keystone	1546
2	JP1, JP2	2-pin header, 0.100" spacing	Würth	61300211121
1	L1	Inductor, shielded drum core, ferrite, 470 nH, 35 A, 0.00032 Ω, SMD	Würth Elektronik eiSos	744301047
1	LBL1	Thermal transfer printable labels, 0.650" W x 0.200" H - 10,000 per roll	Brady	THT-14-423-10
1	Q1	Transistor, NPN, 40 V, 0.2 A, SOT-23	Fairchild Semiconductor	MMBT3904
1	Q2	MOSFET, N-Channel, 60 V, 0.24 A, SOT-23	Vishay-Siliconix	2N7002E-T1-E3
1	R1	Resistor, 100 kΩ, 1%, 0.1 W, 0603	STD	STD
1	R2	Resistor, 10.5 kΩ, 1%, 0.1 W, 0603	STD	STD
4	R3, R5, R10, R18	Resistor, 10.0 kΩ, 1%, 0.1 W, 0603	STD	STD
3	R6, R13, R15	Resistor, 49.9 Ω, 1%, 0.1 W, 0603	STD	STD
1	R7	Resistor, 40.2 kΩ, 1%, 0.1 W, 0603	STD	STD
1	R8	Resistor, 300 Ω, 1%, 0.1 W, 0603	STD	STD
2	R11, R12	Resistor, 51.1 kΩ, 1%, 0.1 W, 0603	STD	STD
1	R14	Resistor, 0 Ω, 5%, 0.1 W, 0603	STD	STD
1	R16	Resistor, 1.0 Ω, 5%, 0.25 W, 1206	STD	STD

Table 11-1. PWR681 List of Materials (continued)

QTY	DES	DESCRIPTION	MANUFACTURER	PART NUMBER
1	R17	Resistor, 0 Ω, 5%, 0.1 W, 0603	STD	STD
1	R20	Resistor, 21.5, 1%, 0.1 W, 0603	STD	STD
1	R21	Resistor, 38.3 kΩ, 1%, 0.1 W, 0603	STD	STD
1	S1	Switch, slide, SPDT 100 mA, SMT	Copal Electronics	CAS-120TA
2	SH-JP1, SH-JP2	Shunt, 100 mil, gold plated, black	3M	969102-0000-DA
6	TP1, TP7, TP8, TP9, TP11, TP12	Test point, miniature, white, TH	Keystone	5002
5	TP2, TP3, TP4, TP6, TP13	Test point, miniature, red, TH	Keystone	5000
2	TP5, TP14	Test point, miniature, black, TH	Keystone	5001
1	TP10	Test point, multipurpose, black, TH	Keystone	5011
1	U1	18 V, 30 A PMBUS Synchronous Buck Converters, RVF0040A	Texas Instruments	TPS544C25RVF
1	U2	3-Terminal Adjustable Current Source, 8-pin Narrow SOIC, Pb-Free	Texas Instruments	LM334SM/NOPB
0	C25, C26	Capacitor, TA, 330 μF, 6.3 V, ±20%, 0.025 Ω, SMD	Sanyo	6TPE330ML
0	FID1, FID2, FID3, FID4, FID5, FID6	Fiducial mark. There is nothing to buy or mount.	N/A	N/A
0	R4	Resistor, 0 Ω, 5%, 0.1 W, 0603	Panasonic	ERJ-3GEY0R00V
0	R9, R19	Resistor, 30.1 kΩ, 1%, 0.1 W, 0603	Vishay-Dale	CRCW060330K1FKEA

12 Revision History

NOTE: Page numbers for previous revisions may differ from page numbers in the current version.

Changes from Revision A (September 2015) to Revision B (August 2021)

Page

- Updated the numbering format for tables, figures, and cross-references throughout the document.3
- Updated the user's guide title..... 3

Changes from Revision * (May 2015) to Revision A (September 2015)

Page

- Added updated EVM Assembly Drawings and PCB Layout drawings..... 39
- Changed C11, C12, C21, C22, C23, C27, C28 description, manufacturer and part number..... 42
- Changed C13, C14, C15, C16 description, manufacturer and part number. 42
- Changed J1 description, manufacturer and part number.....42
- Changed J2 description, manufacturer and part number.....42
- Changed JP1 and JP2 description, manufacturer and part number..... 42
- Changed L1 part number..... 42
- Changed all resistor manufacturer and part numbers to STD. 42

IMPORTANT NOTICE AND DISCLAIMER

TI PROVIDES TECHNICAL AND RELIABILITY DATA (INCLUDING DATA SHEETS), DESIGN RESOURCES (INCLUDING REFERENCE DESIGNS), APPLICATION OR OTHER DESIGN ADVICE, WEB TOOLS, SAFETY INFORMATION, AND OTHER RESOURCES "AS IS" AND WITH ALL FAULTS, AND DISCLAIMS ALL WARRANTIES, EXPRESS AND IMPLIED, INCLUDING WITHOUT LIMITATION ANY IMPLIED WARRANTIES OF MERCHANTABILITY, FITNESS FOR A PARTICULAR PURPOSE OR NON-INFRINGEMENT OF THIRD PARTY INTELLECTUAL PROPERTY RIGHTS.

These resources are intended for skilled developers designing with TI products. You are solely responsible for (1) selecting the appropriate TI products for your application, (2) designing, validating and testing your application, and (3) ensuring your application meets applicable standards, and any other safety, security, regulatory or other requirements.

These resources are subject to change without notice. TI grants you permission to use these resources only for development of an application that uses the TI products described in the resource. Other reproduction and display of these resources is prohibited. No license is granted to any other TI intellectual property right or to any third party intellectual property right. TI disclaims responsibility for, and you will fully indemnify TI and its representatives against, any claims, damages, costs, losses, and liabilities arising out of your use of these resources.

TI's products are provided subject to [TI's Terms of Sale](#) or other applicable terms available either on ti.com or provided in conjunction with such TI products. TI's provision of these resources does not expand or otherwise alter TI's applicable warranties or warranty disclaimers for TI products.

TI objects to and rejects any additional or different terms you may have proposed.

Mailing Address: Texas Instruments, Post Office Box 655303, Dallas, Texas 75265
Copyright © 2022, Texas Instruments Incorporated