

ZB5AK1813

Head for illuminated selector switch, Harmony XB5, XB4, white Ø22 mm 3 position spring return



Main

Range of Product	Harmony XB5
Product or Component Type	Head for illuminated selector switch
Product Compatibility	Integral LED
Device short name	ZB5
Bezel material	Dark grey plastic
Mounting diameter	0.87 in (22 mm)
Head type	Standard
Sale per indivisible quantity	1
Shape of signaling unit head	Round
Type of operator	Right to centre spring return
Operator profile	White standard handle
Operator position information	3 positions +/- 45°

Complementary

CAD overall width	1.14 in (29 mm)
CAD overall height	1.14 in (29 mm)
CAD overall depth	1.69 in (43 mm)
Net Weight	0.04 lb(US) (0.016 kg)
Mechanical durability	1000000 cycles
Station name	XALD 1...5 cut-outs XALK 2...5 cut-outs
Electrical composition code	M3 4 single front mounting integral LED M6 2 single front mounting integral LED and transformer M10 2 single front mounting integral LED MF1 2 single front mounting integral LED MR1 2 single rear mounting integral LED M4 4 single and double front mounting integral LED
Device presentation	Basic element

Environment

Protective treatment	TH
Ambient Air Temperature for Storage	-40...158 °F (-40...70 °C)
Ambient air temperature for operation	-40...158 °F (-40...70 °C)
Overvoltage category	Class II IEC 60536
IP degree of protection	IP66 IEC 60529 IP67 IP69 IP69K
NEMA degree of protection	NEMA 13 NEMA 4X
Resistance to high pressure washer	1015.26 psi (7000000 Pa) 131 °F (55 °C) 0.1 m
IK degree of protection	IK06 IEC 50102

The information provided in this documentation contains general descriptions and/or technical characteristics of the performance of the products contained herein. This documentation is not intended as a substitute for and is not to be used for determining suitability or reliability of these products for specific user applications. It is the duty of any such user or integrator to perform the appropriate and complete risk analysis, evaluation and testing of the products with respect to the relevant specific application or use thereof. Neither Schneider Electric Industries SAS nor any of its affiliates or subsidiaries shall be responsible or liable for misuse of the information contained herein.

Standards	UL 508 EN/IEC 60947-5-1 CSA C22.2 No 14 EN/IEC 60947-1 JIS C8201-5-1 EN/IEC 60947-5-5 EN/IEC 60947-5-4 JIS C8201-1
Product Certifications	BV UL Listed DNV LROS (Lloyds register of shipping) CSA GL
Vibration resistance	5 gn 2...500 Hz)IEC 60068-2-6
Shock resistance	30 gn 18 ms) half sine wave acceleration IEC 60068-2-27 50 gn 11 ms) half sine wave acceleration IEC 60068-2-27

Ordering and shipping details

Category	22467 - PUSHBUTTONS,22MM(PLASTIC) NEW
Discount Schedule	CS2
GTIN	3389110138061
Nbr. of units in pkg.	1
Package weight(Lbs)	0.85 oz (24 g)
Returnability	No
Country of origin	FR

Packing Units

Unit Type of Package 1	PCE
Package 1 Height	1.38 in (3.5 cm)
Package 1 width	1.77 in (4.5 cm)
Package 1 Length	1.97 in (5 cm)
Unit Type of Package 2	S02
Number of Units in Package 2	100
Package 2 Weight	5.80 lb(US) (2.631 kg)
Package 2 Height	5.91 in (15 cm)
Package 2 width	11.81 in (30 cm)
Package 2 Length	15.75 in (40 cm)

Offer Sustainability

Sustainable offer status	Green Premium product
California proposition 65	WARNING: This product can expose you to chemicals including: Di-isodecyl phthalate (DIDP), which is known to the State of California to cause birth defects or other reproductive harm. For more information go to www.P65Warnings.ca.gov
REACH Regulation	REACH Declaration
REACH free of SVHC	Yes
EU RoHS Directive	Pro-active compliance (Product out of EU RoHS legal scope) EU RoHS Declaration
Toxic heavy metal free	Yes
Mercury free	Yes
RoHS exemption information	Yes
China RoHS Regulation	China RoHS Declaration
Environmental Disclosure	Product Environmental Profile
Circularity Profile	End Of Life Information

Contractual warranty

Warranty	18 months
----------	-----------

Dimensions

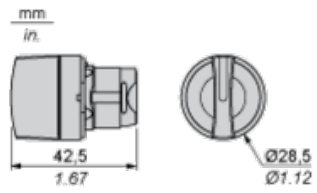

Panel Cut-out for Pushbuttons, Switches and Pilot Lights (Finished Holes, Ready for Installation)

Connection by Screw Clamp Terminals or Plug-in Connectors or on Printed Circuit Board



- (1) Diameter on finished panel or support
- (2) For selector switches and Emergency stop buttons, use of an anti-rotation plate type ZB5AZ902 is recommended.
- (3) $\text{Ø}22.5 \text{ mm}$ recommended ($\text{Ø}22.3_0^{+0.4}$) / $\text{Ø}0.89 \text{ in.}$ recommended ($\text{Ø}0.88 \text{ in.}_0^{+0.016}$)

Connections	a in mm	a in in.	b in mm	b in in.
By screw clamp terminals or plug-in connector	40	1.57	30	1.18
By Faston connectors	45	1.77	32	1.26
On printed circuit board	30	1.18	30	1.18

Detail of Lug Recess

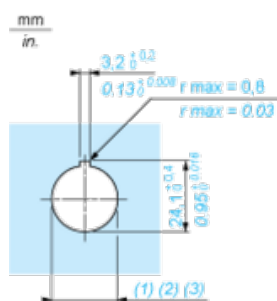

- (1) Diameter on finished panel or support
- (2) For selector switches and Emergency stop buttons, use of an anti-rotation plate type ZB5AZ902 is recommended.
- (3) $\text{Ø}22.5 \text{ mm}$ recommended ($\text{Ø}22.3_0^{+0.4}$) / $\text{Ø}0.89 \text{ in.}$ recommended ($\text{Ø}0.88 \text{ in.}_0^{+0.016}$)

Pushbuttons, Switches and Pilot Lights for Printed Circuit Board Connection

Panel Cut-outs (Viewed from Installer's Side)

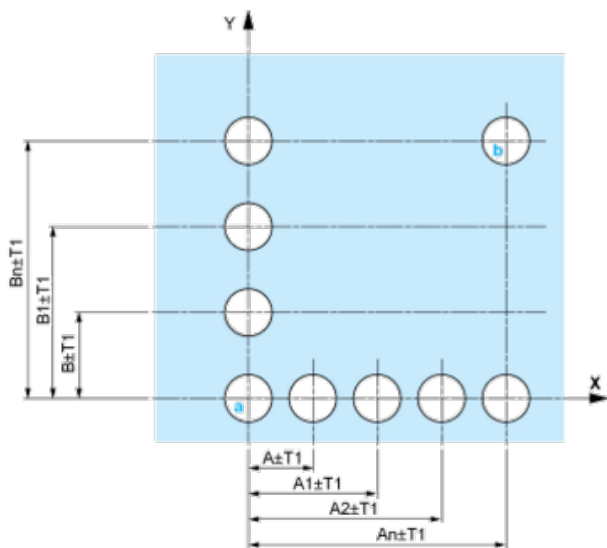

A: 30 mm min. / 1.18 in. min.
 B: 40 mm min. / 1.57 in. min.

Printed Circuit Board Cut-outs (Viewed from Electrical Block Side)

Dimensions in mm



A: 30 mm min.
 B: 40 mm min.
 Dimensions in in.



A: 1.18 in. min.
 B: 1.57 in. min.

General Tolerances of the Panel and Printed Circuit Board

The cumulative tolerance must not exceed 0.3 mm / 0.012 in.: $T1 + T2 = 0.3 \text{ mm max.}$

Installation Precautions

- Minimum thickness of circuit board: 1.6 mm / 0.06 in.
- Cut-out diameter: 22.4 mm \pm 0.1 / 0.88 in. \pm 0.004
- Orientation of body/fixing collar ZB5AZ009: $\pm 2^\circ 30'$ (excluding cut-outs marked a and b).
- Tightening torque of screws ZBZ006: 0.6 N.m (5.3 lbf.in) max.
- Allow for one ZB5AZ079 fixing collar/pillar and its fixing screws:
 - every 90 mm / 3.54 in. horizontally (X), and 120 mm / 4.72 in. vertically (Y).
 - with each selector switch head (ZB5AD*, ZB5AJ*, ZB5AG*).

The fixing centers marked a and b are diagonally opposed and must align with those marked 4 and 5.



- (1) Head ZB5AD*
 (2) Panel
 (2) Nut
 (4) Printed circuit board

Mounting of Adapter (Socket) ZBZ01•

- 1 2 elongated holes for ZBZ006 screw access
- 2 1 hole $\varnothing 2.4 \text{ mm} \pm 0.05 / 0.09 \text{ in.} \pm 0.002$ for centring adapter ZBZ01•
- 3 8 $\times \varnothing 1.2 \text{ mm} / 0.05 \text{ in.}$ holes
- 4 1 hole $\varnothing 2.9 \text{ mm} \pm 0.05 / 0.11 \text{ in.} \pm 0.002$, for aligning the printed circuit board (with cut-out marked a)
- 5 1 elongated hole for aligning the printed circuit board (with cut-out marked b)
- 6 4 holes $\varnothing 2.4 \text{ mm} / 0.09 \text{ in.}$ for clipping in adapter ZBZ01•

Dimensions An + 18.1 relate to the $\varnothing 2.4 \text{ mm} \pm 0.05 / 0.09 \text{ in.} \pm 0.002$ holes for centring adapter ZBZ01•.

Electrical Composition Corresponding to Code M3



Electrical Composition Corresponding to Code M4



Electrical Composition Corresponding to Codes M6 and P2



Electrical Composition Corresponding to Codes M5, M10, MF1, MR1 and MF2



Legend

Single contact

Double contact

Light block

Possible location



Sequence of Contacts Fitted to 3-position Selector Switch Body

Position 315°



Push	Position	Top			
Bottom					
Location		Left	Right		
State		1	0		
Contacts	N/O		closed	open	
N/C		open	closed		





Position 0°



Push	Position	Top			
Bottom					
Location		Left	Right		
State		0	0		
Contacts	N/O		open	open	
N/C		closed	closed		

Position 45°



Push	Position	Top			
Bottom					
Location		Left	Right		
State		0	1		
Contacts	N/O		open	closed	
N/C		closed	open		