

Simon

Kit Information & Instructions

Red then green...no, blue?...wait!...BUZZ! Remember the classic game of Simon? Well, we have a build-your-own Simon kit that will sharpen your reaction time while teaching you basic soldering (a useful skill in its own right).

After you have successfully built a working Simon game, you will have a greater knowledge of through-hole soldering and the tools, techniques, and terminology required to populate your own PCB prototype. Additionally, the source code and design files are available, making this project a great entryway into microcontrollers and embedded programming. Game on!

Kit includes:

- ATmega microcontroller
- Buzzer
- 0.1 μ F Cap (*qty: 2*)
- 10K Resistor
- LEDs (*qty: 4*)
- Slide Switch (*qty: 2*)
- Battery Clips (*qty: 4*)
- AA Batteries (*qty: 2*)
- Button pad
- Bezel
- Standoffs and screws (*qty: 4*)
- Simon PCB board

! SOLDERING TIPS

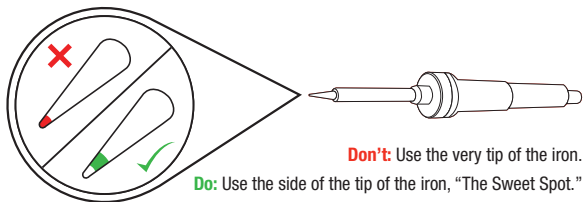

Do: Touch the iron to the component leg and metal ring at the same time.



Do: While continuing to hold the iron in contact with the leg and metal ring, feed solder into the joint.



Don't: Glob the solder straight onto the iron and try to apply the solder with the iron.



Do: Use a sponge to clean your iron whenever black oxidation builds up on the tip.

! SOLDERING TIPS



A Solder flows around the leg and fills the hole - forming a volcano-shaped mound of solder.



B **Error:** Solder balls up on the leg, not connecting the leg to the metal ring.
Solution: Add flux, then touch up with iron.



C **Error:** Bad Connection (i.e. it doesn't look like a volcano)
Solution: Flux then add solder.



D **Error:** Bad Connection...and ugly...oh so ugly.
Solution: Flux then add solder.



E **Error:** Too much solder connecting adjacent legs (aka a solder jumper).
Solution: Wick off excess solder.

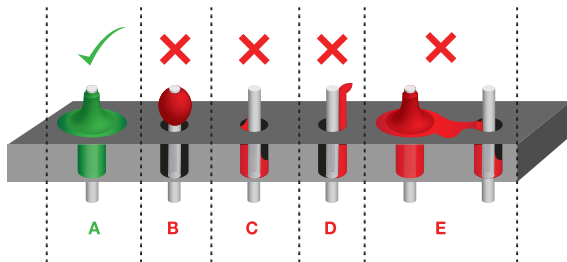

- 1 Locate the **10K Resistor**.



- 2 Bend the legs downward.

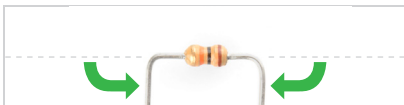

- 3 Locate the **10K Resistor** position on the board.

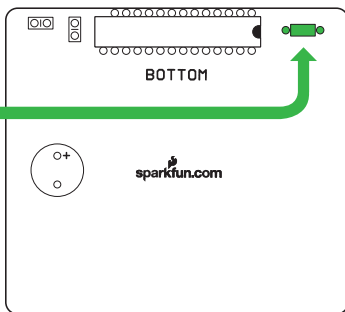

- 4 Insert the resistor into the PCB.



- 5 Push the resistor in so it is nearly flush with the board.



- 6 Slightly bend the legs outward to hold it in place.



- 7 Flip the board over. Hold the soldering iron's "Sweet Spot" so it touches both the leg and the metal ring. Hold for 2 seconds.

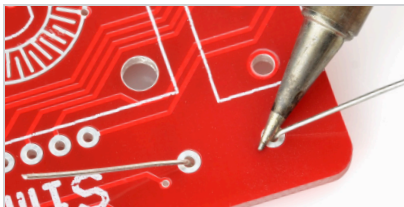

- 8 Feed solder into the joint.

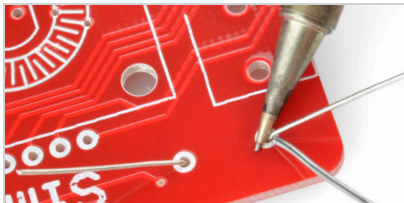

- 9 First, pull away the solder. Second, pull away the iron.

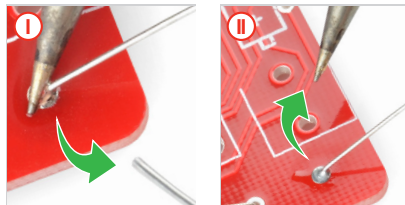

- 10 Your solder joints should look like this - a tiny volcano.

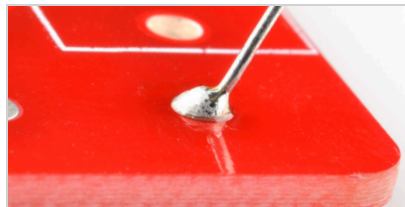

- 11 Clip off any excess legs.

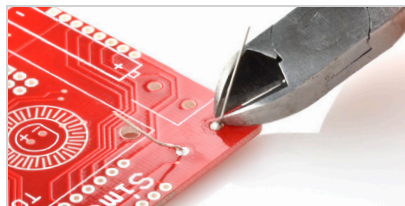



CONTINUE WITH THE **BOTTOM OF THE BOARD**

[STEPS 12 TO 14]



Now that you've successfully soldered in the resistor, use the same method to place and solder the rest of the components.



Steps highlighted with a yellow warning triangle represent a polarized component. Pay special attention to the component's markings indicating how to place it on the board.



12 0.1µF Cap x 2

0.1µF Cap (decoupling cap): Insert the capacitors, flip the board over and solder.



13 ATmega328

ATmega (microcontroller): Looking at the bottom of the board, insert the microcontroller. Make sure the notch on the chip aligns with the white silk screen on the board. Flip the board over, then begin to solder.



14 Buzzer

Buzzer (alarm): Insert the buzzer. The "+" on the buzzer should align with the white "+" on the board. Flip the board over and solder into place.

Very Important. Make sure to align the notch **here**.

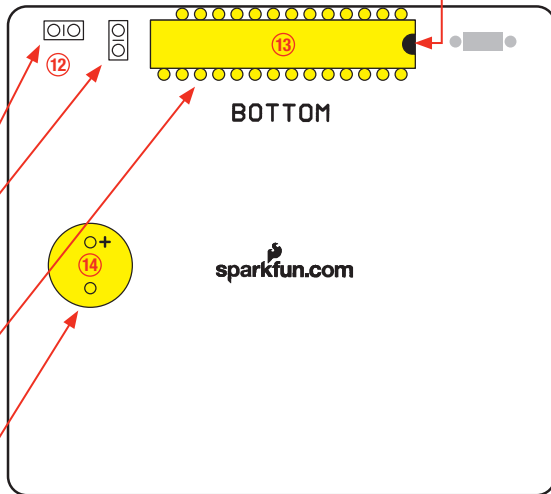

BOTTOM OF BOARD



NOW WORK ON THE TOP OF THE BOARD

[STEPS 15 TO 17]



Remember highlighted components are polarized.



15 LEDs x 4

LEDs (indicator lights): Insert the four LEDs into the front of the board. Each LED has a short leg and a long leg. The short leg goes into the hole labeled “-.” Also make sure it sits flush with the PCB. Then solder into place.



16 Battery Clips x 4

Battery Clips (hold batteries): Insert battery clips, make sure clips point toward each other so the battery fits. Ensure clips are flat against the board. Then solder from the bottom of board.



17 Slide Switches x 2

Slide Switches (sound and power): Looking at the top of the board, insert switches. Keep the iron tip away! Plastic melts easily. Flip the board over, then begin to solder.

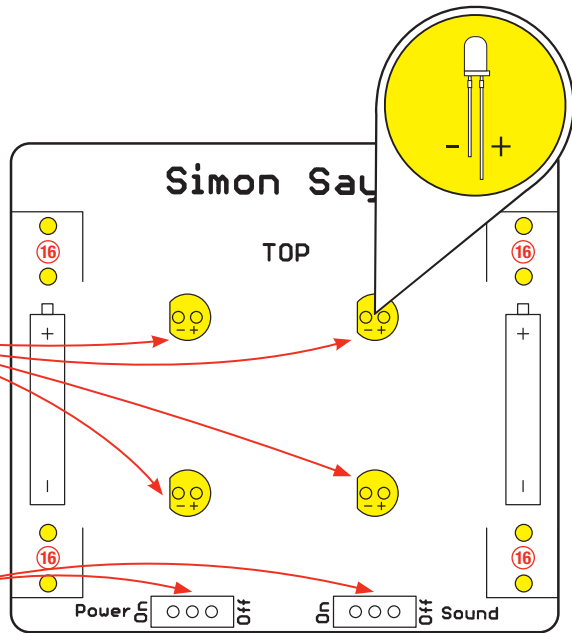

TOP OF BOARD

FINAL ASSEMBLY

[STEPS 18 TO 21]



No screwdriver necessary.
Please only hand-tighten the screws and standoffs.



18 Button Pad

Button Pad (game control): Attach to top. Lay rubber button pad over LEDs.



19 Bezel

Bezel (holds button pad): Attach to top. Lay bezel over button pad, with notches for the screws pointing up.



20 Screws x 4

Standoffs and screws (mechanical): Insert the screws through the bezel and button pad, then twist standoffs onto the protruding screw. Hand tighten.



21 AA Batteries x 2

AA Batteries (power source): Insert the batteries, following “+” and “-” indicators on the board. Turn on the board and verify the LEDs are flashing.

TOP SIDE VIEW

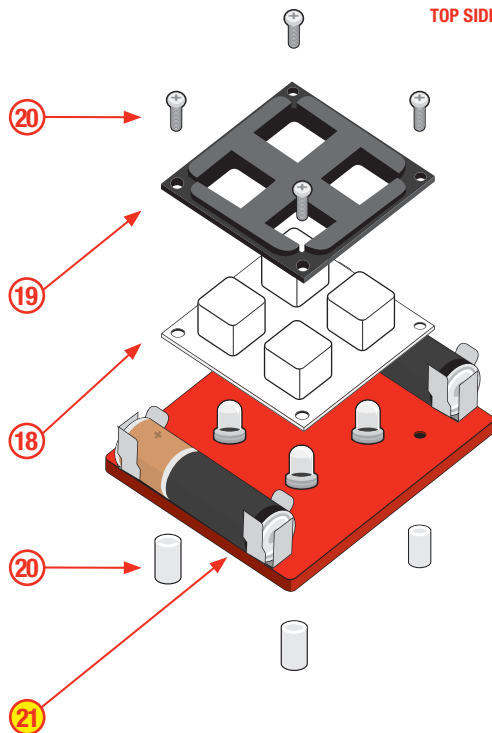

CONGRATULATIONS, YOU'RE DONE!!!

Your Simon game is now completed. Turn it on and have fun! If something is not working (i.e. an LED won't light up), please check out our troubleshooting tips in the back of this booklet [pages 16-19].

CREATE YOUR OWN PROJECT WITH SIMON

Did you know that your Simon is much more than it seems? It can be re-programmed to do many different things! You can write code to change your Simon into a new unique project. To learn more, please check out our online tutorial here: sparkfun.com/tutorials/203

And for even more fun stuff go here: learn.sparkfun.com

EXTRA FUN

As an example of how the Simon is more than just a game, we have included a special feature in the code. Just for fun, try this out. Don't worry it won't change your Simon permanently.

- I Turn off power switch.



- II Press any one button.



- III While holding button down, turn back on.

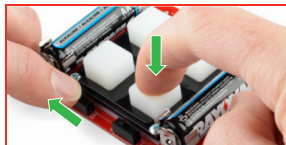

! TROUBLESHOOTING LEDs



Failing LEDs? Don't fret, there is an easy way to fix it! The most common cause of a failing LED is incorrect polarity. We have designed a special trick into the Simon PCB. You can simply cut the two traces and close two jumpers. This will swap the polarity without having to remove the LED.

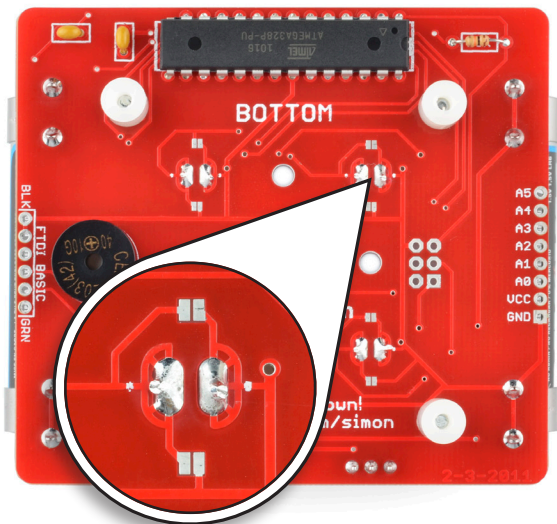

I Using a hobby knife, cut both traces directly over the white dots.



II Using a soldering iron, close both jumpers.



❗ TROUBLESHOOTING JUMPERS

Did you accidentally solder a jumper between two legs? Don't fret! Here is a simple process using solder wick to remove the excess solder.

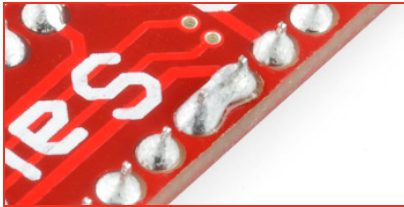

I Locate a piece of solder wick.



II Place solder wick on top of solder.

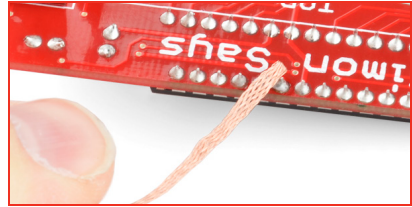

III Place iron on top of solder wick. Hold for 3-4 seconds.

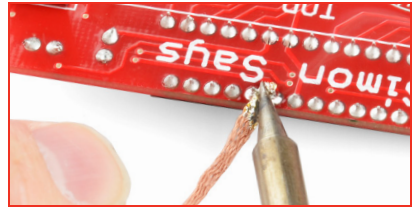

IV Once the solder begins to flow into the wick, pull the wick and iron away at the same time.

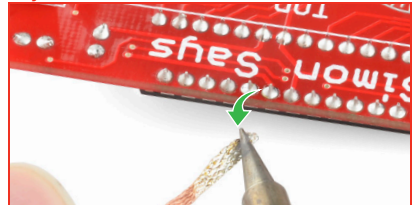

Learning More

Microcontroller and PCB

The microcontroller is the brain of the game. It's programmed to light up the buttons and create the game sequence. Bending the legs won't hurt the chip – it is designed to withstand the heat of the soldering iron as well as gentle bending.

Try to be gentle with the board, but a few scratches are not a big deal.

Soldering

The tip of the iron is normally 700 °F, hot enough to melt metal. It is normal for the handle of the soldering iron to heat up a bit. Hold it like a pencil and move your hand further away from the tip if the heat is uncomfortable. The solder smokes because the rosin inside the solder is burning off - it's not harmful.

Buzzer and Other Components

The buzzer makes the noise for the game – pretty simple! The capacitors help “clean up” the power on the board. The resistor tells the microcontroller not to reset once the power is turned on, so your game can continue uninterrupted. The slide switches turn on and off the power and sound.

LEDs

Light-emitting diodes (LEDs) are like light bulbs, but much smaller and more efficient.

Buttons, Bezels, and Standoffs

Squishy buttons are fun! The bezel helps hold the buttons in place. The standoffs hold the board up off a surface, helping to protect the electronics. They also hold the pad and bezel onto the board.