

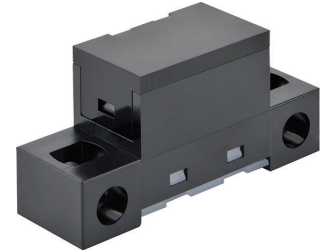

# B5W-DB

## Diffuse Reflective Sensor

- Super miniature long-distance diffuse reflective sensor that can be installed anywhere
- Designed to be immune to ambient light
- Screws can be mounted from 4 directions





Refer to "Safety Precautions" on page 5.

### Model

B5W-DB     -

(1) (2) (3) (4) (5)

- |                    |                             |                   |                                 |  |
|--------------------|-----------------------------|-------------------|---------------------------------|--|
| <b>(1) Size</b>    | <b>(2) Sensing distance</b> | <b>(3) Output</b> | <b>(4) Degree of protection</b> | <b>(5) Minimum number of deliverable units</b> |
| 1: Super miniature | 4: 550 mm                   | 5: NPN/Light-ON   | 2: Supported                    | 1: 1 piece<br>2: 1,500 pieces                  |

### Type (Consult your trading company for the prices.)

#### ■ Device [Dimensions → P.4]

Sensing method	Appearance	Size	Connecting method	Output type	Sensing distance	Operation mode	Model	Minimum number of deliverable units (Unit: piece)
Diffuse reflective		Super miniature	Connector	NPN open collector	550 mm	Light-ON *1	B5W-DB1452-1	1
							B5W-DB1452-2	1500

\*1. In case of light-ON, control output is turned ON when a sensing object is detected.

### Accessories (order separately)

#### ■ Connector with cable As it is not supplied with the sensor, order as needed.

Appearance	Cord length	Model	Applicable model
	1 m	EE-5002 1 M	B5W-DB1452-1 B5W-DB1452-2

# B5W-DB

## Ratings and Specifications

### ■ Digital output models

Sensing method		Diffuse reflective
Item	Model	B5W-DB1452-1, B5W-DB1452-2
Sensing distance (white paper)	550 mm	
Hysteresis	30% max.	
Light source (wavelength)	Infrared LED (850 nm)	
Power supply voltage	12 VDC±10% including 10% ripple (p-p)	
Current consumption	20 mA max. (at 13.2 VDC)	
Operating mode	Light-ON *1	
Control output	Load power supply voltage: 13.2 VDC, Load current: 50 mA max., Residual voltage: 0.8 V max. at 50 mA load current and 0.32 V max. at 10 mA load current, Open collector output (NPN)	
Response time	Operate/reset: 1 ms max.	
Ambient illumination	Illumination on the surface of the receiver Incandescent lamp: 3,000 lx max., Sunlight: 10,000 lx max.	
Ambient temperature range	Operating: -10 to +60°C, Storage: -25 to +80°C (with no icing or condensation)	
Vibration resistance	10 to 55 Hz, 1.5-mm double amplitude for 2 h each in X, Y, and Z directions	
Shock resistance	500 m/s <sup>2</sup> 3 times each in X, Y and Z directions	
Degree of protection	IEC IP50 (not including terminals)	
Connecting method	Connector models	
Weight (unit only)	Approx. 1.6 g	
Materials	Case	Polycarbonate (PC)
	Lens	Acrylic (PMMA)
	Cover	Polycarbonate (PC)

\*1. In case of light-ON, control output is turned ON when a sensing object is detected.

## I/O Circuit Diagrams

### ■ NPN output

Model	Operating mode	Timing charts	Output circuit								
B5W-DB1452-1 B5W-DB1452-2	Light-ON	<p>*1</p>	<table border="1"> <thead> <tr> <th>Terminal No.</th> <th>Name</th> </tr> </thead> <tbody> <tr> <td>(1)</td> <td>GND</td> </tr> <tr> <td>(2)</td> <td>Vout</td> </tr> <tr> <td>(3)</td> <td>Vcc</td> </tr> </tbody> </table>	Terminal No.	Name	(1)	GND	(2)	Vout	(3)	Vcc
Terminal No.	Name										
(1)	GND										
(2)	Vout										
(3)	Vcc										

\*1. "Incident light" means there is a sensing object. "No incident light" means there is no sensing object.

## Engineering Data (Reference Value)

### Operating Range (Left and Right)

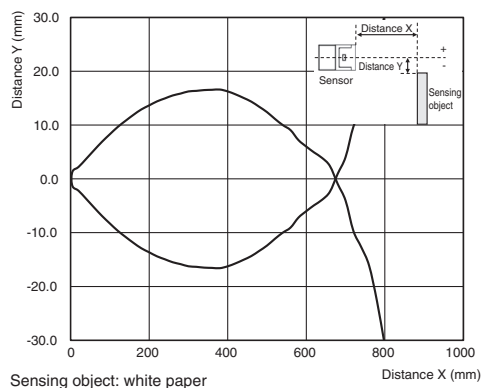

### Operating Range (Up and Down)

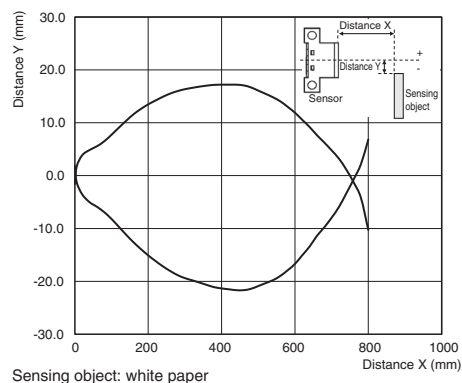

### Receiver Output-Sensing Distance Characteristics

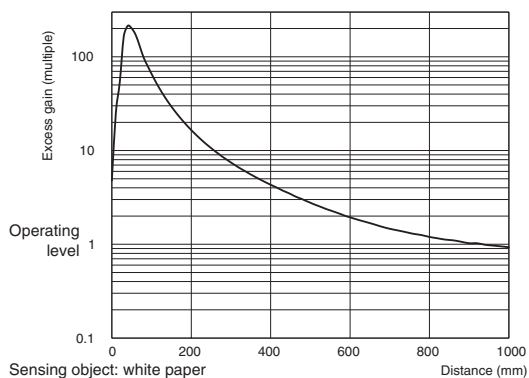

### Size of Sensing Object-Distance Characteristics

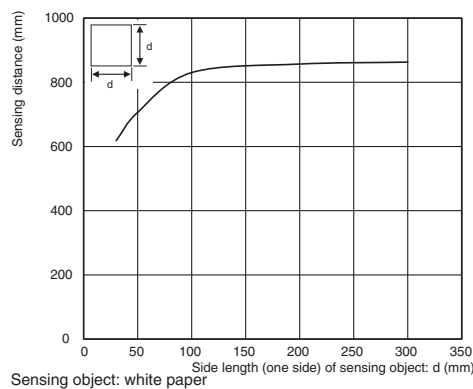

### Angle Characteristics (Left and Right)

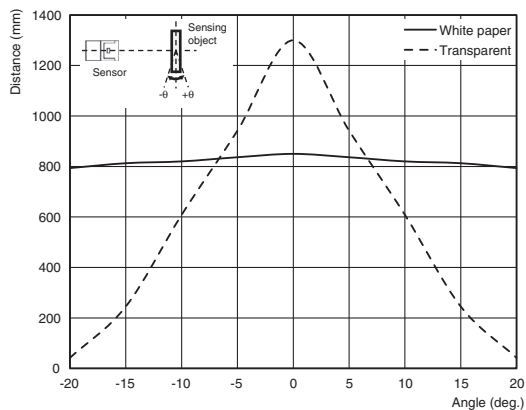

### Angle Characteristics (Up and Down)

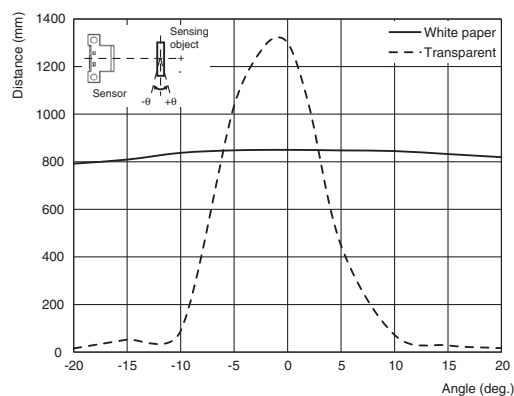

# B5W-DB

## Dimensions

**CAD Data** marked products, 2D drawings and 3D CAD models are available.  
For CAD information, please visit our website, which is noted on the last page.

(Unit: mm)  
Unspecified dimension tolerance: tolerance class IT16

**CAD Data**

B5W-DB1452-1  
B5W-DB1452-2

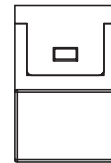
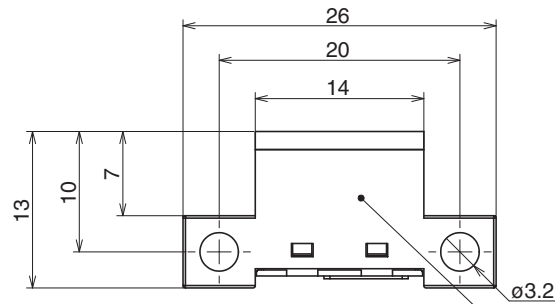
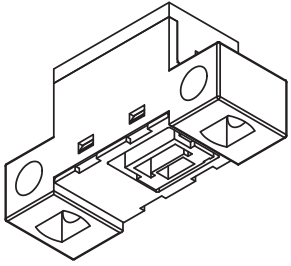
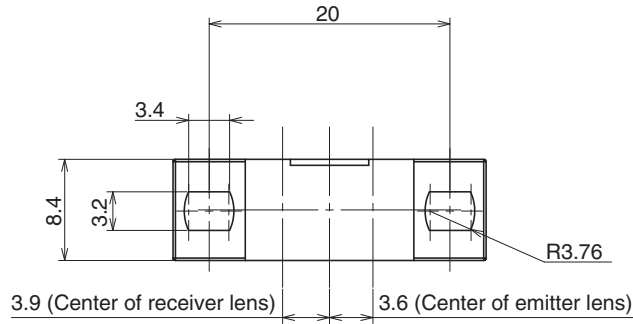
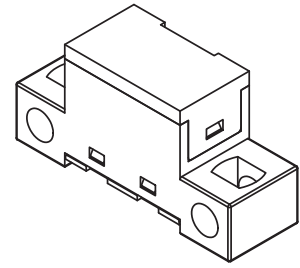

Mark  
(Brand mark, model name, Lot No. QR code)

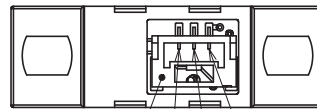

BM03B-GHLE-TBT  
manufactured by JST

(3) (2) (1)

Terminal No.	Name
(1)	GND
(2)	Vout
(3)	Vcc

## Connector with cable (order separately)

EE-5002 1M

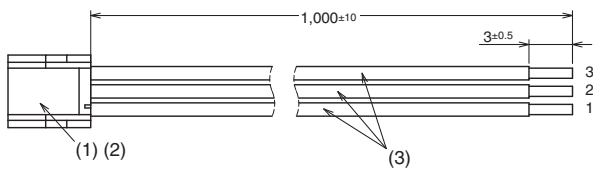

No.	Product Name	Model/specifications	Quantity	Manufacturer
(1)	Connector, HS for 101-150 harness	GHR-03V-S	1	JST
(2)	Connector, CT for 101-150 harness	SSHL-002TP0.2	3	JST
(3)	Lead wire	UL1061 AWG26	3	-

### Wiring Table

Connector circuit number	Lead wire color
1	Blue
2	Black
3	Brown

## Safety Precautions

To ensure safe operation, be sure to read and follow the Terms and Conditions Agreement.

### Warning

This product cannot be used in safety devices for presses or other safety devices used to protect human life. This product is designed for use in applications for sensing workpieces and workers that do not affect safety.



### Caution

This product is not designed or rated for ensuring safety of persons either directly or indirectly. Do not use it for such purposes.



### Precautions for Safe Use

To ensure safety, observe the following precautions.

#### Wiring

##### Power Supply Voltage

Do not use the product with voltage or current in excess of the operating voltage or current. Applying any excessive voltage or current or supplying AC power to a DC-type sensor may cause the sensor to explode or burn.

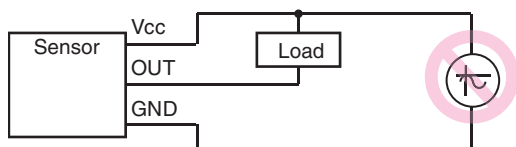

##### Load Short-Circuit

Do not short-circuit the load. Otherwise the product may be damaged or it may burn.

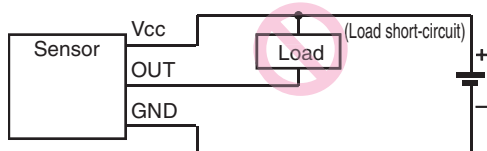

##### Faulty Wiring

Do not miswire such as the polarity of the power supply voltage. Otherwise, the product may be damaged or it may burn.

Example 1) Wrong polarity

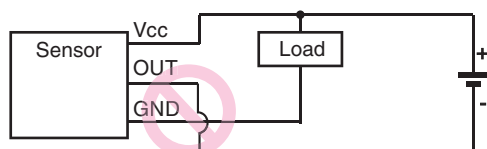
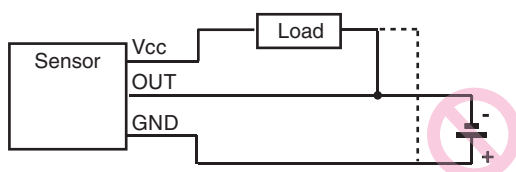
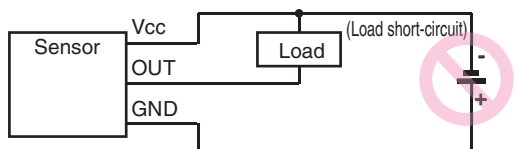

##### Connection without load

If the power supply is connected directly without a load, the internal elements may explode or burn. Be sure to insert a load when connecting the power supply.

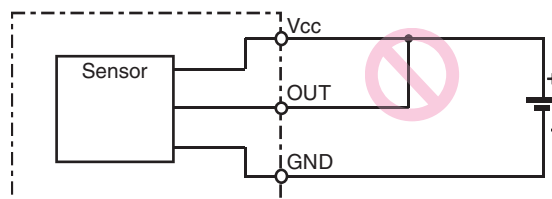

##### AND Connection

With an AND connection as shown in the figure below, a voltage is applied to Vcc while GND of sensor 2 is not securely grounded. A failure may occur. Do not make this kind of connection. Also in some models, an inrush current may occur in sensor 2 when sensor 1 is turned on, causing failure or malfunction.

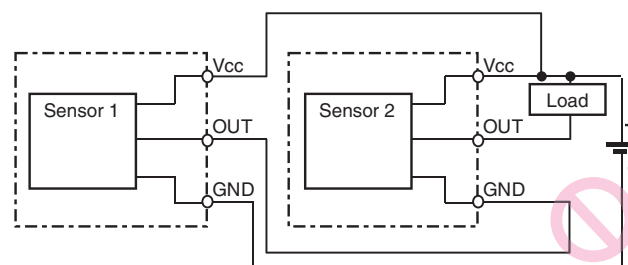

##### Storage and Operating Environment

- (1) Places where the product is not exposed to corrosive gases, such as hydrogen sulfide gas, or salty wind.
- (2) Places where it is not exposed to direct sunlight.
- (3) Make sure that flux, oil, or other chemicals do not adhere to the surface of the emitter and receiver.
- (4) Do not apply a load that may deform or deteriorate the product in any circumstances.
- (5) Store the product in a normal temperature, humidity, and pressure environment.
- (6) The product should be used without freezing or condensation.
- (7) Do not use the product in atmospheres or environments that exceed product ratings.
- (8) This product does not have a water-proof structure. Therefore, do not use it in an application or environment where it will be subjected to splashes from water, oil, or any other liquid.

## Precautions for Correct Use

### ● Mounting

- (1) Ambient light may cause the sensor to malfunction. In such case, mount the sensor at an angle that ambient light does not enter the receiver lens. Make sure that the sensor is not affected by ambient light.
- (2) Mount the sensor securely on a flat surface.
- (3) Use M3 screws to secure the sensor (use together with spring washers and 6-mm-diameter flat washers to prevent screws from loosening). Use a tightening torque of 0.54 N·m max.
- (4) Take care that nothing comes into contact with the detected part of the sensor. Damage to the sensing element will result in poor performance.
- (5) Before using the sensor, check to make sure that it has not become loose due to vibration or shock.

### ● Wiring

#### Surge Prevention

- (1) If there is a surge in the power supply line, try connecting a Zener diode or a capacitor (with a capacitance of 0.1 to 1  $\mu\text{F}$ ), depending on the operating environment. Use the sensor only after confirming that the surge has been removed.  
We recommended use of 20 to 25 V Zener diodes for a 12 VDC power supply.

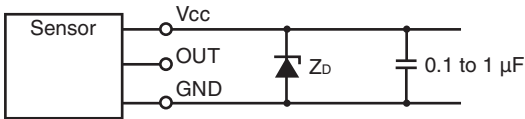

Z<sub>D</sub>: Zener diode

- (2) Do not use a small inductive load, such as a relay.

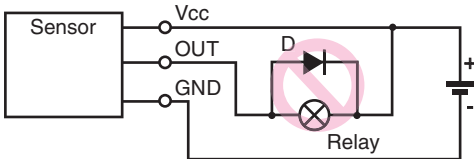

- (3) Separate the wiring for the sensor from high-voltage lines or power lines. If the wiring is routed in the same conduit or duct as such lines, the sensor may malfunction or may be damaged by inductive interference.
- (4) Make sure that the connectors are securely locked.

### ● Handling During Wiring

- (1) If a force is applied to the connection area between the terminal and connector by bending or pulling the cable after the wiring is completed, the connector contact part or connection area with the cable may be damaged, resulting in contact failure. Make sure that a stress (external force) as shown in the figure below is not applied to the connection area between the terminal and connector when routing and connecting cables or harnesses.
- (2) Do not perform cord wiring when power supply voltage is applied. Doing so may result in breakage.

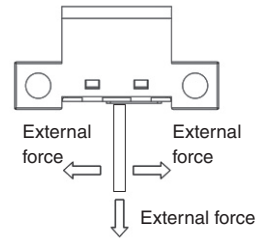

### ● Design

#### Precautions about this sensor

A modulated-light type of the sensors is used. When designing, give proper consideration to the power supply and cable lengths used.

The sensors are more easily affected than the sensors with Nonmodulated Light.

#### Reasons for Interference from Power and Cable Length on the Sensors with Modulated Light

An LED emitter is pulse-lighted to produce modulated light. A large current momentarily flows to the sensors in sync with this pulse timing. This causes a pulsating consumption current. A photoelectric sensor incorporates a capacitor with sufficient capacity, and is virtually unaffected by the pulse of the consumption current. With this sensor, however, it is difficult to have a capacitor with a sufficient capacity. Accordingly, when the cable length is long or depending on the type of power source, it may become impossible to keep up with the pulse of the consumption current and operation may become unstable.

#### Countermeasures

##### <Adding a Capacitor>

- Attach a capacitor of 10  $\mu\text{F}$  min. to the wires as close as possible to the sensor. (Use a capacitor with a dielectric strength that is at least twice the sensor's power supply voltage. Do not use tantalum capacitors. A short-circuit may cause the capacitor to ignite due to the large current flow.)

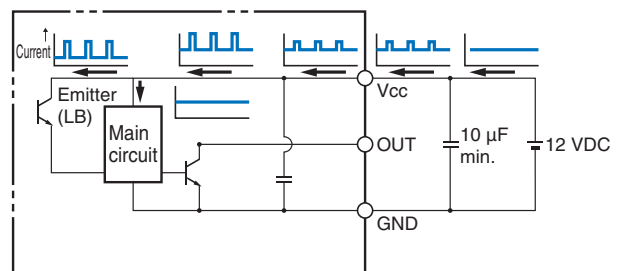

### <Extending Cable Length>

- Design the configuration so that the maximum cable length for the sensor is 2 m.

- When using a cable longer than 2 m, attach a capacitor (e.g., an aluminum electrolytic capacitor) with a capacity of 10  $\mu\text{F}$  min. to the wires. The distance between the sensor and the capacitor must be within 2 m.

Make sure that the total cable length is no longer than 5 m. To use a cable length longer than 5 m, use a PLC or other means to read the sensor output and then transmit the signals using a PLC's communications.

- Although cables are capable of being extended longer than 5 m, performance is likely to be affected by cable specifications and noise interference from adjacent cables and other devices.

Voltage drops due to the resistance of the cable material itself will also influence performance. Therefore, factors such as the difference in voltage between the end of the cable and the sensor and noise levels, must be given full consideration.

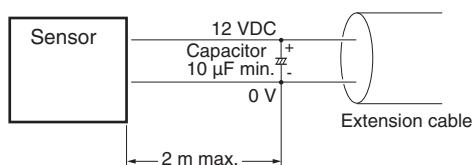

### <Countermeasures for Switching Power Supplies>

- Take either of the following countermeasures as required if connecting a sensor to a switching power supply.
  - (1) Attach a capacitor of 10  $\mu\text{F}$  min. to the wires as close as possible to the sensor. (Use a capacitor with a dielectric strength that is at least twice the sensor's power supply voltage. Do not use tantalum capacitors. A short-circuit may cause the capacitor to ignite due to the large current flow.)

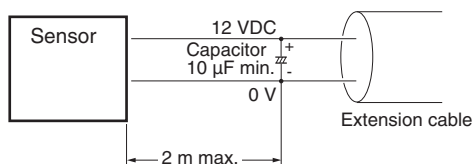

- (2) Connect to the 0-V line of the power source or connect to the power source via a capacitor of approximately 0.47  $\mu\text{F}$  to reduce the impedance of the mounting base to prevent inductive noise from entering the mounting base.

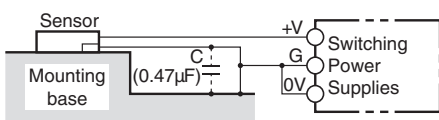

- (3) Connect the noise filter terminal (neutral terminal to ACG) of the switching power supply to the case (FG) and 0-V terminal of the power supply.

### <Countermeasures to Handle Inductive Noise>

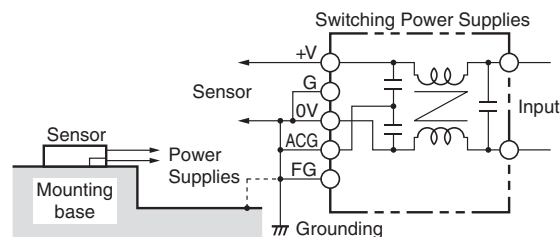

- (4) Insert a plastic insulator of approximately 10 mm between the sensor and the mounting base.

### <Effects of Inductive Noise>

- When there is inductive noise in the sensor mounting base (metal), the sensor may enter the same state as light receiving. In this case, ensure that there is no electrical potential difference between the sensor 0 V terminal and the sensor mounting base (metal), or put a 0.47  $\mu\text{F}$  capacitor between the 0 V terminal and the base (metal).

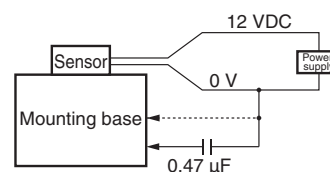

### <Effects When the Power Supply is Turned On>

An output pulse may occur when the power supply is turned ON depending on the power supply and other conditions. Use the sensor in the stable ready-for-detection state reached in 100 ms after turning on the power supply.

Please check each region's Terms & Conditions by region website.

---

## **OMRON Corporation**

**Device & Module Solutions Company**

### **Regional Contact**

#### **Americas**

<https://components.omron.com/us>

#### **Asia-Pacific**

<https://components.omron.com/ap>

#### **Korea**

<https://components.omron.com/kr>

#### **Europe**

<https://components.omron.com/eu>

#### **China**

<https://components.omron.com.cn>

#### **Japan**

<https://components.omron.com/jp>