

Solid State PIN Control Products

0.5-18 GHz and 2-18 GHz

Super-Slim High Performance Drop-In PIN Switches



- Reflective and Absorptive
- SPST thru SP6T and Transfer (Standard)
- High Speed
- High Isolation – up to 80 dB
- Low Insertion Loss
- Drop-In Applications
- Integral TTL Drivers
- Hermetically Sealed
- Full MIL Specifications

Description

The super-slim series of broadband, hermetically sealed switches offers fast switching speed and low insertion loss in very compact packages. Both 0.5 to 18 GHz and 2 to 18 GHz models are available. The switches are gold plated and have removable SMA connectors for use in drop-in applications. Superior RF performance is achieved over the entire bandwidth due to the use of selected PIN diodes and optimum RF circuit designs.

All models include integral drivers with reverse voltage protection. The drivers are TTL compatible and are tailored to each RF circuit to give optimum switching performance.

The small size, high speed, broad bandwidth and low insertion loss make these switches ideal for EW systems, automatic test equipment and simulators.

Solid State PIN Control Products

Specifications

Reflective Switches, SMA (F), 0.5 to 18 GHz

MODEL	TYPE	SWITCHING TIME MODULATION (ns)	BAND SEGMENTS (GHz)	INSERTION LOSS (dB max.)	VSWR (max.)	ISOLATION (dB min.)	POWER HANDLING (mW)	POWER SUPPLY REQUIREMENTS	
								mA @+5 V	mA @-12 V
SS212DHS	SPST	15	0.5-2	1.1	1.6	70	200	50	50
			2-4	1.3	1.7	70			
			4-8	1.6	1.8	70			
			8-12	2.1	1.9	70			
			12-18	2.6	2.0	70			
SS122DHS	SP2T	20	0.5-2	1.5	1.8	70	200	90	60
			2-4	1.5	1.9	75			
			4-8	2.0	1.9	70			
			8-12	2.4	2.0	65			
			12-18	2.9	2.0	60			
SS132DHS	SP3T	20	0.5-2	1.5	1.8	70	200	90	60
			2-4	1.5	1.9	75			
			4-8	2.0	1.9	70			
			8-12	2.5	2.0	65			
			12-18	3.0	2.0	60			
SS142DHS	SP4T	20	0.5-2	1.6	1.8	70	200	110	70
			2-4	1.6	1.9	75			
			4-8	2.1	1.9	70			
			8-12	2.6	2.0	65			
			12-18	3.2	2.0	60			
SS152DHS	SP5T	20	0.5-2	2.0	1.8	70	200	220	90
			2-4	2.0	1.9	70			
			4-8	2.5	2.0	70			
			8-12	3.0	2.0	65			
			12-18	3.6	2.0	60			
SS162DHS	SP6T	20	0.5-2	2.0	1.8	70	200	260	100
			2-4	2.0	1.9	70			
			4-8	2.5	2.0	70			
			8-12	3.0	2.0	65			
			12-18	3.6	2.0	60			

Solid State PIN Control Products

Absorptive Switches, SMA (F), 0.5 to 18 GHz

MODEL	TYPE	SWITCHING TIME MODULATION (ns)	BAND SEGMENTS (GHz)	INSERTION LOSS (dB max.)	VSWR (max.)	ISOLATION (dB min.)	POWER HANDLING (mW)	POWER SUPPLY REQUIREMENTS	
								mA @+5 V	mA @-12 V
SS212DHTS	SPST	30	0.5-12 12-18	2.4 2.8	1.9 2.0	55 50	200	50	60
SS212DHTS-80	SPST	30	0.5-12 12-18	2.4 2.8	1.9 2.0	80 70	200	60	60
SS122DHTS	SP2T	30	0.5-12 12-18	2.7 3.1	1.9 2.0	60 55	200	60	60
SS122DHTS-80	SP2T	30	0.5-12 12-18	2.2 2.9	2.0 2.0	80 70	200	90	60
SS132DHTS	SP3T	30	0.5-12 12-18	2.9 3.4	1.9 2.0	60 45	200	105	75
SS142DHTS	SP4T	30	0.5-12 12-18	2.9 3.4	1.9 2.0	60 45	200	110	80
SS152DHTS	SP5T	30	0.5-12 12-18	3.3 4.0	2.0 2.0	60 50	200	220	90
SS162DHTS	SP6T	30	0.5-12 12-18	3.3 4.0	2.0 2.0	60 50	200	250	100

Solid State PIN Control Products

Specifications

Reflective Switches, SMA (F), 2 to 18 GHz

MODEL	TYPE	SWITCHING TIME MODULATION (ns)	BAND SEGMENTS (GHz)	INSERTION LOSS (dB max.)	VSWR (max.)	ISOLATION (dB min.)	POWER HANDLING (mW)	POWER SUPPLY REQUIREMENTS	
								mA @+5 V	mA @-12 V
SS213DHS	SPST	15	2-4	1.2	1.8	50	500	50	50
			4-8	1.4	1.9	65			
			8-12	1.9	1.9	60			
			12-18	2.4	2.0	60			
SS213DHS-80	SPST	15	2-4	1.3	1.8	80	500	60	40
			4-8	1.5	1.9	80			
			8-12	1.9	2.0	80			
			12-18	2.5	2.0	80			
SS123DHS	SP2T	15	2-4	1.5	1.9	75	200	90	60
			4-8	2.0	1.9	70			
			8-12	2.4	2.0	65			
			12-18	2.9	2.0	60			
SS123DHS-80	SP2T	15	2-4	1.5	1.8	80	200	90	60
			4-8	1.9	1.9	80			
			8-12	2.2	2.0	80			
			12-18	2.9	2.0	80			
SS133DHS	SP3T	15	2-4	1.5	1.9	75	200	90	60
			4-8	2.0	1.9	70			
			8-12	2.5	2.0	65			
			12-18	3.0	2.0	60			
SS143DHS	SP4T	15	2-4	1.6	1.9	75	200	110	70
			4-8	2.1	1.9	70			
			8-12	2.6	2.0	65			
			12-18	3.0	2.0	60			
SS153DHS	SP5T	20	2-4	2.0	1.9	70	200	220	90
			4-8	2.5	2.0	70			
			8-12	3.0	2.0	65			
			12-18	3.6	2.0	60			
SS163DHS	SP6T	20	2-4	2.0	1.9	70	200	250	100
			4-8	2.5	2.0	70			
			8-12	3.0	2.0	65			
			12-18	3.6	2.0	60			

Transfer Switch, SMA (F), 2 to 18 GHz

MODEL	TYPE	SWITCHING TIME (ns)	BAND SEGMENTS (GHz)	INSERTION LOSS (dB max.)	VSWR (max.)	ISOLATION (dB min.)	POWER HANDLING (mW)	POWER SUPPLY REQUIREMENTS	
								mA @+5 V	mA @-12 V
XSS323CDHS	XFER	50	2-4	1.8	1.8	70	200	80	80
			4-8	2.2	1.9	70			
			8-12	2.1	2.0	60			
			12-18	2.6	2.0	55			

Solid State PIN Control Products

Absorptive Switches, SMA (F), 2 to 18 GHz

MODEL	TYPE	SWITCHING TIME MODULATION (ns)	BAND SEGMENTS (GHz)	INSERTION LOSS (dB max.)	VSWR (max.)	ISOLATION (dB min.)	POWER HANDLING (mW)	POWER SUPPLY REQUIREMENTS	
								mA @+5 V	mA @-12 V
SS213BDHTS	SPST	20	2-4	1.5	1.9	65	200	40	60
		20	4-8	1.7	1.9	60			
		20	8-12	2.1	1.9	55			
		25	12-16	2.5	2.0	50			
		25	16-18	2.5	2.0	50			
SS123BDHTS	SP2T	20	2-4	1.6	1.9	65	200	60	60
		20	4-8	1.8	1.9	65			
		20	8-12	2.5	1.9	60			
		25	12-16	2.9	2.0	55			
		25	16-18	2.9	2.0	55			
SS133BDHTS	SP3T	20	2-4	1.8	1.9	65	200	105	75
		20	4-8	2.0	1.9	65			
		20	8-12	2.7	1.9	60			
		25	12-16	3.2	2.0	50			
		25	16-18	3.2	2.0	45			
SS143BDHTS	SP4T	20	2-4	1.8	1.9	65	200	105	75
		20	4-8	2.0	1.9	65			
		20	8-12	2.7	1.9	60			
		25	12-16	3.2	2.0	50			
		25	16-18	3.2	2.0	45			
SS153BDHTS	SP5T	25	2-4	2.2	1.9	65	200	220	90
		25	4-8	2.7	2.0	65			
		25	8-12	3.2	2.0	60			
		25	12-16	3.8	2.0	50			
		25	16-18	3.8	2.0	50			
SS163BDHTS	SP6T	25	2-4	2.2	1.9	65	200	250	100
		25	4-8	2.7	2.0	65			
		25	8-12	3.2	2.0	60			
		25	12-16	3.8	2.0	50			
		25	16-18	3.8	2.0	50			

Solid State PIN Control Products

Electrical Specifications

TTL CONTROL LOGIC

Logic 0 (0-0.8 V, 1.6 mA max. sink @ 0.4 V) = Insertion Loss
Logic 1 (2.0-5.5 V, 40 μ A max. source @ 2.4 V) = Isolation

FOR TRANSFER SWITCH (XSS323CDHS)

Logic 0: J1-J4 and J2-J3 at Insertion Loss
Logic 1: J1-J2 and J4-J3 at Insertion Loss

SWITCHING TIME

T on = 50% TTL to 90% of RF voltage
T off = 50% TTL to 10% of RF voltage

SWITCHING RATE

5 MHz max. PRF @50% duty cycle

DRIVER

Reverse voltage protected

SURVIVAL POWER at 25°C (Cold Switching)

1.0 W CW, 20W Peak (1 μ s max. pulse width, 5% duty cycle)
Derate linearly to 50% at +95°C

Environmental Specifications

TEMPERATURE

Operating -54°C to +95°C
Storage -65°C to +125°C

HUMIDITY

Per MIL-STD-202F, method 103B, condition B
(96 hours at 95% R.H.)

SHOCK

Per MIL-STD-202F, method 213B, condition B
(75 G, 6 ms)

ALTITUDE

Per MIL-STD-202F, method 105C, condition B
(50,000 feet)

VIBRATION

Per MIL-STD-202F, method 204D, condition B
(.06" double amplitude or 15 G, whichever is less)

THERMAL SHOCK

Per MIL-STD-202F, method 107D, condition A (5 cycles)

Options

- Very Low Loss Video Leakage
- Inverted TTL Logic Control
- BCD Decoder Driver
- Package Configuration
- Over Voltage Protection

Solid State PIN Control Products

Outline Drawings

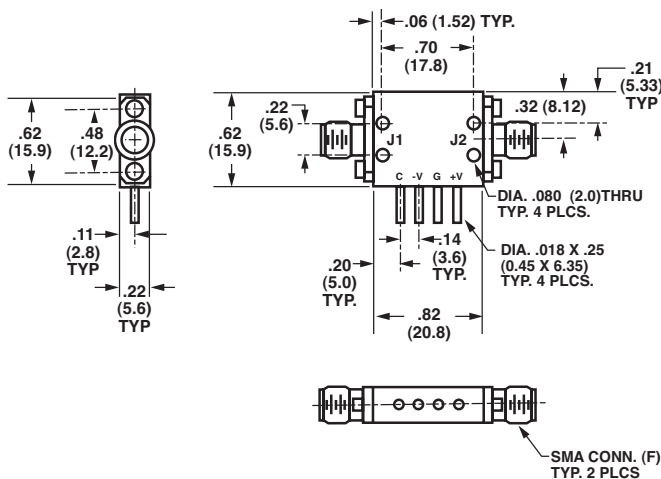

SS213DHS, SS213BDHTS

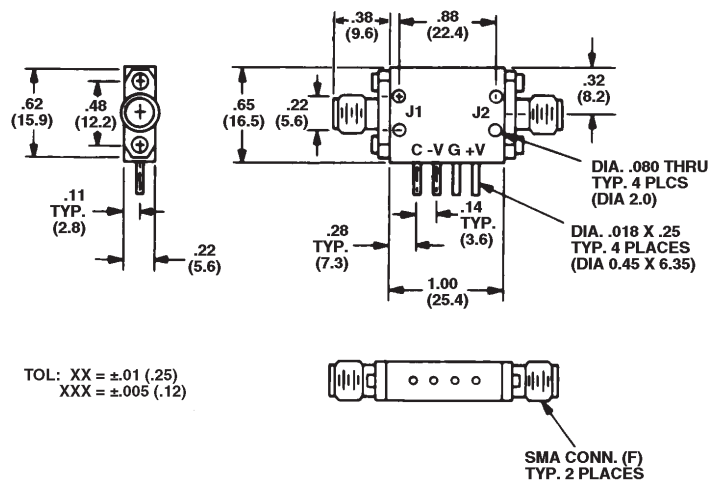

SS213DHS-80, SS212DHS, SS212DHTS

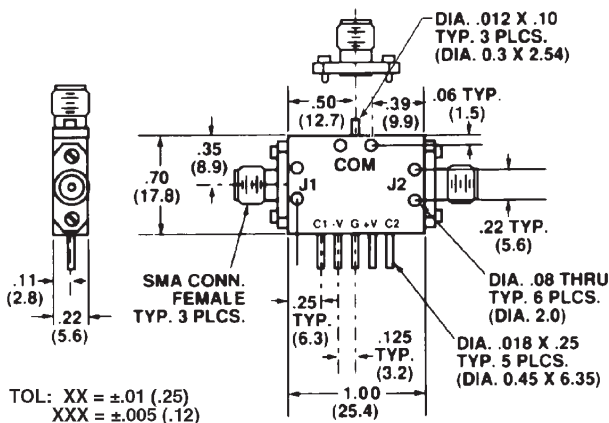

SS123DHS, SS123BDHTS, SS122DHS,
SS123DHS-80, SS122DHTS

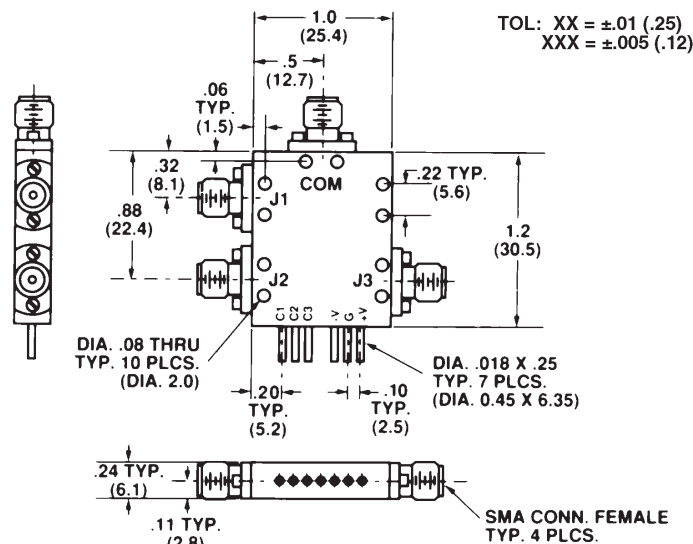

SS133DHS, SS133BDHTS, SS132DHS,
SS132DHTS

Dimensions in inches (mm in parentheses), unless otherwise specified.

Solid State PIN Control Products

Outline Drawings

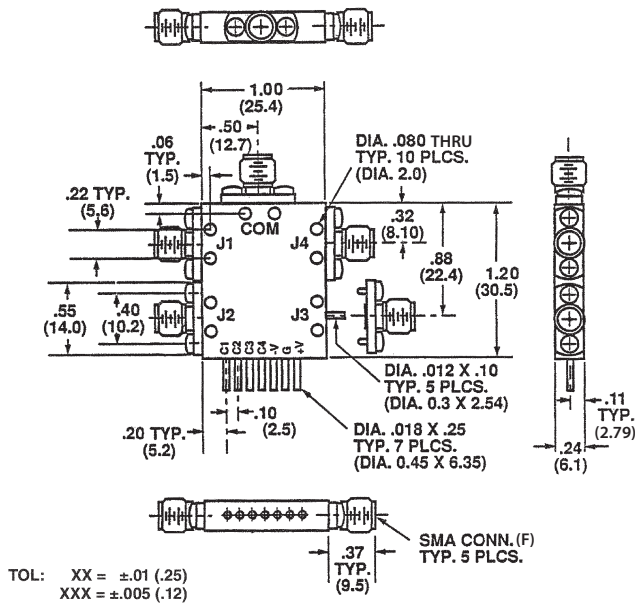

SS143DHS, SS143BDHTS, SS142DHS, SS142DHTS

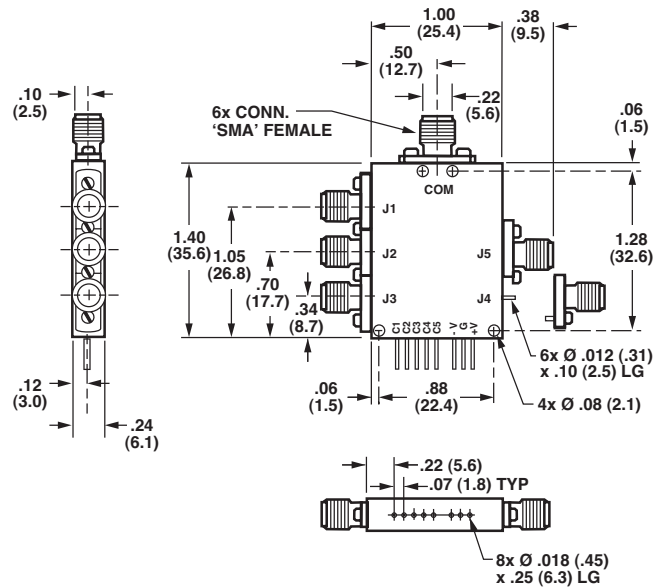

SS153DHS, SS153BDHTS, SS152DHTS, SS152DHS

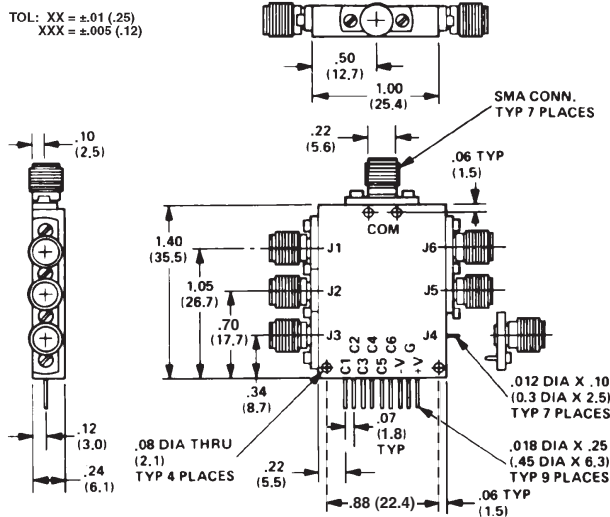

SS163DHS, SS163BDHTS, SS162DHS, SS162DHTS

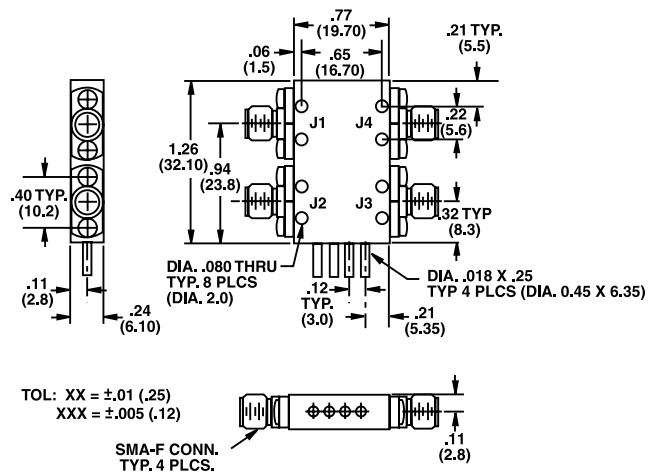

XSS323CDHS

Dimensions in inches (mm in parentheses), unless otherwise specified.