

# MAX98304

## Mono 3.2W Class D Amplifier

### General Description

The MAX98304 mono 3.2W Class D amplifier provides Class AB audio performance with Class D efficiency. This device offers five selectable gain settings (0dB, 3dB, 6dB, 9dB, and 12dB) set by a single gain-select input (GAIN).

Active emissions-limiting, edge-rate, and overshoot control circuitry greatly reduces EMI. A filterless spread-spectrum modulation scheme eliminates the need for output filtering found in traditional Class D devices. These features reduce application component count.

The IC's 0.95mA at 3.7V (1.2mA at 5V) quiescent current extends battery life in portable applications.

The IC is available in a 9-bump (1.0mm x 1.0mm) WLP with 0.3mm pitch that is specified over the extended -40°C to +85°C temperature range.

### Applications

Notebook and Netbook Computers  
 Cellular Phones  
 Tablets  
 MP3 Players  
 Portable Audio Players  
 VoIP Phones

### Typical Application Circuit

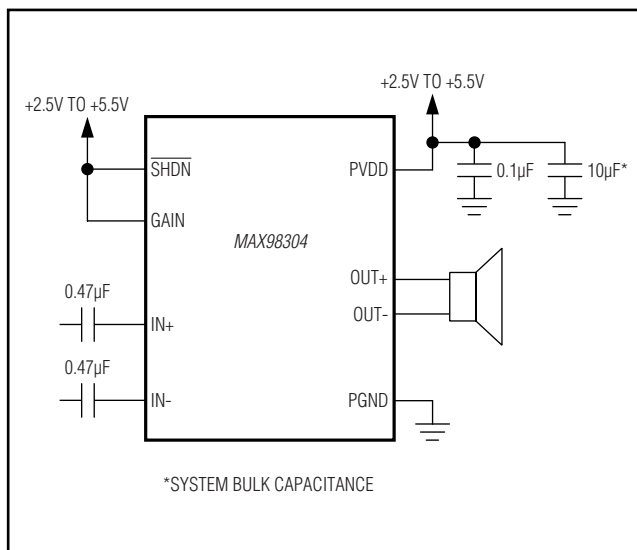

### Features

- ◆ Low Quiescent Current: 0.95mA at 3.7V
- ◆ Spread Spectrum and Active Emissions Limiting
- ◆ Five Pin-Selectable Gains
- ◆ 19µVRMS Ultra-Low Noise
- ◆ 90dB PSRR
- ◆ Click-and-Pop Suppression
- ◆ Thermal and Overcurrent Protection
- ◆ Low-Current Shutdown Mode
- ◆ 1.0mm x 1.0mm, 9-Bump WLP (0.3mm Pitch) Space-Saving Package

### Ordering Information

| PART         | TEMP RANGE     | PIN-PACKAGE | TOP MARK |
|--------------|----------------|-------------|----------|
| MAX98304EWL+ | -40°C to +85°C | 9 WLP       | AIR      |

+Denotes a lead(Pb)-free/RoHS-compliant package.

Visit [www.maximintegrated.com/products/patents](http://www.maximintegrated.com/products/patents) for product patent marking information.

### Bump Configuration

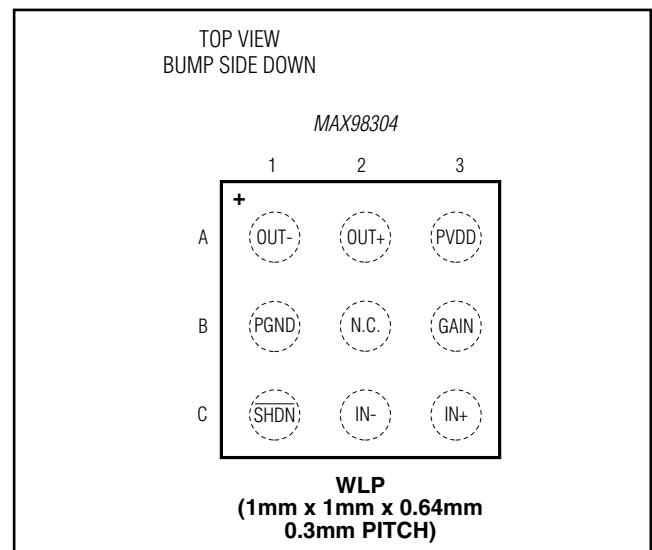

# MAX98304

## Mono 3.2W Class D Amplifier

### ABSOLUTE MAXIMUM RATINGS

PVDD, IN+, IN-,  $\overline{\text{SHDN}}$ , GAIN to PGND.....-0.3V to +6V  
 All Other Pins to PGND .....-0.3V to (VPVDD + 0.3V)  
 Continuous Current Into/Out of PVDD, PGND, OUT\_...  $\pm 750\text{mA}$   
 Continuous Input Current (all other pins).....  $\pm 20\text{mA}$   
 Duration of Short Circuit Between  
     OUT\_ and PVDD, PGND ..... Continuous  
     OUT+ and OUT- ..... Continuous

Continuous Power Dissipation ( $T_A = +70^\circ\text{C}$ ) for Multilayer Board  
     9-Bump WLP (derate 10.6mW/ $^\circ\text{C}$ ) .....848mW  
 Junction Temperature .....+150 $^\circ\text{C}$   
 Operating Temperature Range.....-40 $^\circ\text{C}$  to +85 $^\circ\text{C}$   
 Storage Temperature Range.....-65 $^\circ\text{C}$  to +150 $^\circ\text{C}$   
 Soldering Temperature (reflow) .....+260 $^\circ\text{C}$

*Stresses beyond those listed under "Absolute Maximum Ratings" may cause permanent damage to the device. These are stress ratings only, and functional operation of the device at these or any other conditions beyond those indicated in the operational sections of the specifications is not implied. Exposure to absolute maximum rating conditions for extended periods may affect device reliability.*

### ELECTRICAL CHARACTERISTICS

(VPVDD =  $\overline{\text{VSHDN}}$  = 5.0V, VPGND = 0V, Av = 12dB (GAIN = PGND), RL =  $\infty$ , RL connected between OUT+ to OUT-, AC measurement bandwidth 20Hz to 22kHz, TA = TMIN to TMAX, unless otherwise noted. Typical values are at TA = +25 $^\circ\text{C}$ .) (Notes 1, 2)

| PARAMETER                   | SYMBOL | CONDITIONS   | MIN             | TYP       | MAX       | UNITS         |
|-----------------------------|--------|--|-----------------|-----------|-----------|---------------|
| Supply Voltage Range        | PVDD   | Inferred from PSRR test  | 2.5             |           | 5.5       | V             |
| Undervoltage Lockout        | UVLO   | PVDD falling   | 1.5             | 1.8       | 2.2       | V             |
| Quiescent Supply Current    | IDD    | TA = +25 $^\circ\text{C}$  |                 | 1.2       | 1.8       | mA            |
|                             |        | VPVDD = 3.7V   |                 | 0.95      |           |               |
| Shutdown Supply Current     | ISHDN  | $\overline{\text{VSHDN}}$ = 0V, TA = +25 $^\circ\text{C}$                              |                 | < 0.1     | 10        | $\mu\text{A}$ |
| Turn-On Time                | tON    |  |                 | 3.4       | 10        | ms            |
| Bias Voltage                | VBIAS  |  |                 | VPVDD / 2 |           | V             |
| Input Resistance            | RIN    | TA = +25 $^\circ\text{C}$ ,<br>single-ended  | Av = 12dB       | 45        | 70        | k $\Omega$    |
|                             |        |  | Av = 9dB        | 64        | 100       |               |
|                             |        |  | Av = 6dB        | 90        | 140       |               |
|                             |        |  | Av = 3dB        | 128       | 200       |               |
|                             |        |  | Av = 0dB        | 180       | 280       |               |
| Voltage Gain                | Av     | Connect GAIN to PGND   | 11.5            | 12        | 12.5      | dB            |
|                             |        | Connect GAIN to PGND<br>through 100k $\Omega$ $\pm 5\%$                                | 8.5             | 9         | 9.5       |               |
|                             |        | Connect GAIN to PVDD   | 5.5             | 6         | 6.5       |               |
|                             |        | Connect GAIN to PVDD<br>through 100k $\Omega$ $\pm 5\%$                                | 2.5             | 3         | 3.5       |               |
|                             |        | GAIN unconnected   | -0.5            | 0         | +0.5      |               |
| Output Offset Voltage       | VOS    | TA = +25 $^\circ\text{C}$ (Note 3)   |                 | $\pm 1$   | $\pm 4.5$ | mV            |
| Click and Pop               | KCP    | Peak voltage,<br>A-weighted, 32<br>samples per second,<br>RL = 8 $\Omega$ (Notes 3, 4) | Into shutdown   |           | -74       | dBV           |
|                             |        |  | Out of shutdown |           | -60       |               |
| Common-Mode Rejection Ratio | CMRR   | fIN = 1kHz, input referred   |                 | 80        |           | dB            |

# MAX98304

## Mono 3.2W Class D Amplifier

### ELECTRICAL CHARACTERISTICS (continued)

(VPVDD = VSHDN = 5.0V, VPGND = 0V, AV = 12dB (GAIN = PGND), RL = ∞, RL connected between OUT+ to OUT-, AC measurement bandwidth 20Hz to 22kHz, TA = TMIN to TMAX, unless otherwise noted. Typical values are at TA = +25°C.) (Notes 1, 2)

| PARAMETER                                | SYMBOL | CONDITIONS                                  | MIN                    | TYP   | MAX  | UNITS |   |
|--|--------|---|------------------------|-------|------|-------|---|
| Power-Supply Rejection Ratio<br>(Note 3) | PSRR   | VPVDD = 2.5V to 5.5V, TA = +25°C            |                        | 72    | 90   | dB    |   |
|  |        |   | f = 217Hz              |       | 80   |       |   |
|  |        | VRIPPLE = 200mVP-P                          | f = 1kHz               |       | 84   |       |   |
|  |        |   | f = 20kHz              |       | 84   |       |   |
| Output Power                             | POUT   | THD+N = 10%,<br>f = 1kHz,<br>RL = 4Ω + 33μH | VPVDD = 5.0V           |       | 3.2  | W     |   |
|  |        |   | VPVDD = 4.2V           |       | 2.2  |       |   |
|  |        |   | VPVDD = 3.7V           |       | 1.7  |       |   |
|  |        | THD+N = 1%,<br>f = 1kHz,<br>RL = 4Ω + 33μH  | VPVDD = 5.0V           |       | 2.6  |       |   |
|  |        |   | VPVDD = 4.2V           |       | 1.8  |       |   |
|  |        |   | VPVDD = 3.7V           |       | 1.4  |       |   |
|  |        | THD+N = 10%,<br>f = 1kHz,<br>RL = 8Ω + 68μH | VPVDD = 5.0V           |       | 1.8  |       |   |
|  |        |   | VPVDD = 4.2V           |       | 1.2  |       |   |
|  |        |   | VPVDD = 3.7V           |       | 0.96 |       |   |
|  |        | THD+N = 1%,<br>f = 1kHz,<br>RL = 8Ω + 68μH  | VPVDD = 5.0V           |       | 1.4  |       |   |
|  |        |   | VPVDD = 4.2V           |       | 1    |       |   |
|  |        |   | VPVDD = 3.7V           |       | 0.8  |       |   |
| Total Harmonic Distortion<br>Plus Noise  | THD+N  | fIN = 1kHz                                  | RL = 4Ω<br>POUT = 1W   |       | 0.03 | 0.1   | % |
|  |        |   | RL = 8Ω<br>POUT = 0.7W |       | 0.03 |       |   |
| Oscillator Frequency                     | fOSC   |   |                        | 300   |      | kHz   |   |
| Spread-Spectrum Bandwidth                |        |   |                        | ±12.5 |      | kHz   |   |
| Efficiency                               | η      | POUT = 1.75W, RL = 8Ω                       |                        | 93    |      | %     |   |
| Noise                                    | VN     | A-weighted (Note 3)                         | AV = 12dB              |       | 31   | μVRMS |   |
|  |        |   | AV = 9dB               |       | 26   |       |   |
|  |        |   | AV = 6dB               |       | 23   |       |   |
|  |        |   | AV = 3dB               |       | 21   |       |   |
|  |        |   | AV = 0dB               |       | 19   |       |   |
| Output Current Limit                     | ILIM   |   |                        | 2.8   |      | A     |   |
| Thermal Shutdown Level                   |        |   |                        | 155   |      | °C    |   |
| Thermal Shutdown Hysteresis              |        |   |                        | 15    |      | °C    |   |
| <b>DIGITAL INPUT (SHDN)</b>              |        |   |                        |       |      |       |   |
| Input-Voltage High                       | VINH   | VPVDD = 2.5V to 5.5V                        |                        | 1.4   |      | V     |   |
| Input-Voltage Low                        | VINL   | VPVDD = 2.5V to 5.5V                        |                        |       | 0.4  | V     |   |
| Input Leakage Current                    |        | TA = +25°C                                  |                        |       | ±1   | μA    |   |

**Note 1:** This device is 100% production tested at +25°C. All temperature limits are guaranteed by design.

**Note 2:** Testing performed with a resistive load in series with an inductor to simulate an actual speaker load. For RL = 4Ω, L = 33μH. For RL = 8Ω, L = 68μH.

**Note 3:** Amplifier inputs AC-coupled to ground.

**Note 4:** Mode transitions controlled by SHDN.

# MAX98304

## Mono 3.2W Class D Amplifier

### Typical Operating Characteristics

( $V_{PVDD} = V_{SHDN} = 5.0V$ ,  $V_{PGND} = 0V$ ,  $A_V = 6dB$ ,  $R_L = \infty$ ,  $R_L$  connected between  $OUT+$  to  $OUT-$ , AC measurement bandwidth 20Hz to 22kHz,  $T_A = +25^\circ C$ , unless otherwise noted.)

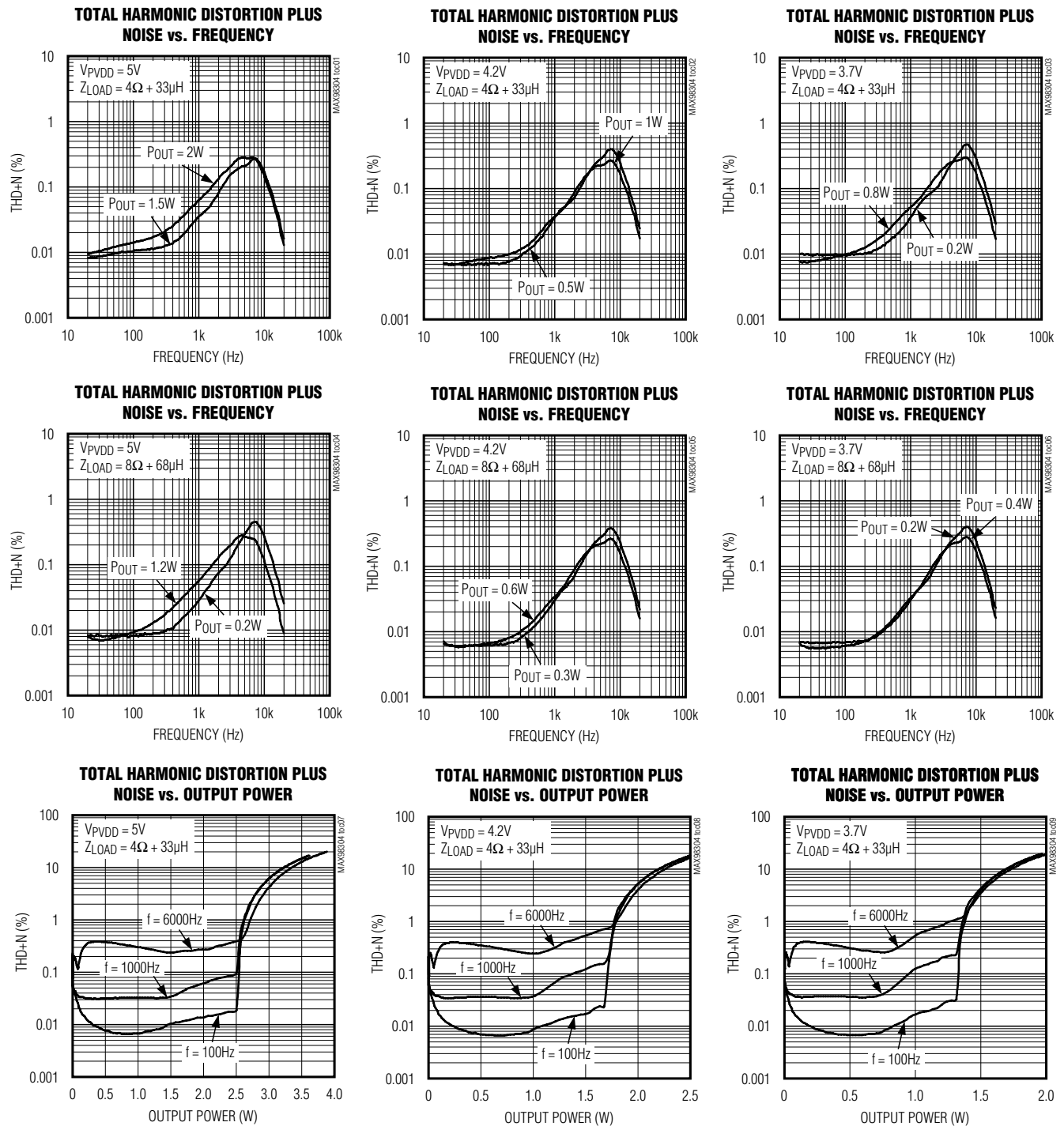

# MAX98304

## Mono 3.2W Class D Amplifier

### Typical Operating Characteristics (continued)

( $V_{PVDD} = V_{SHDN} = 5.0V$ ,  $V_{PGND} = 0V$ ,  $A_V = 6dB$ ,  $R_L = \infty$ ,  $R_L$  connected between  $OUT+$  to  $OUT-$ , AC measurement bandwidth 20Hz to 22kHz,  $T_A = +25^\circ C$ , unless otherwise noted.)

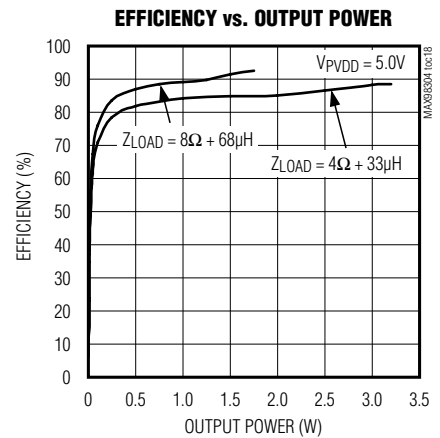
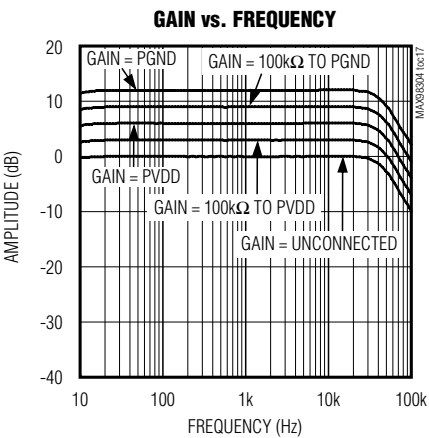
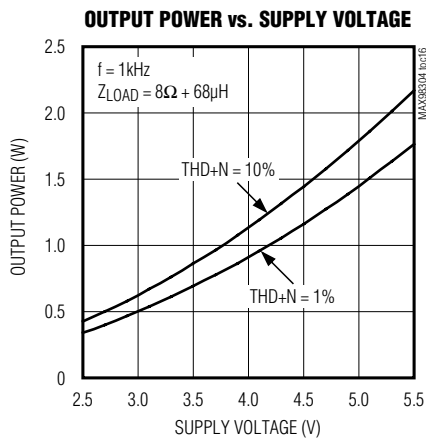
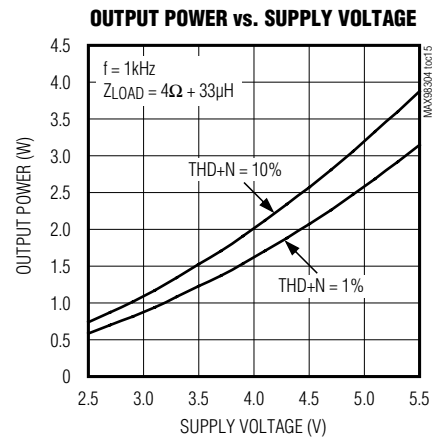
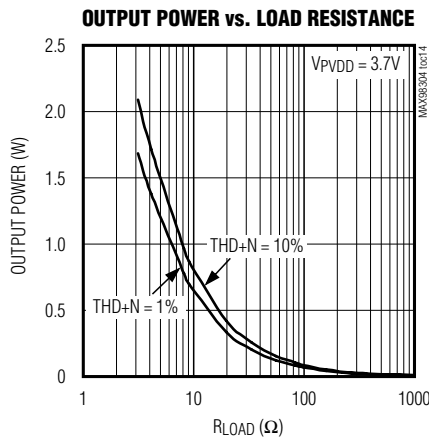
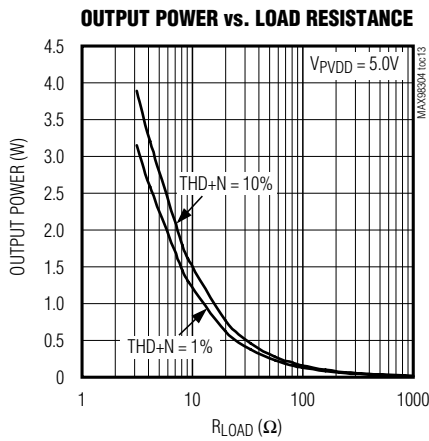
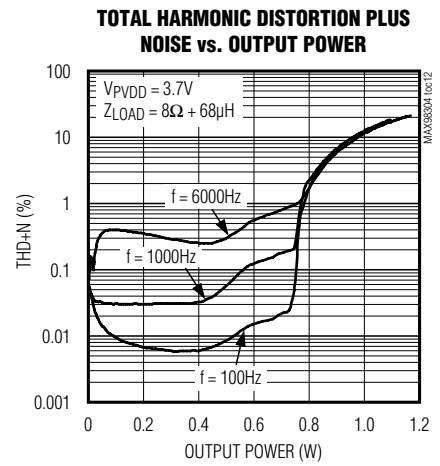
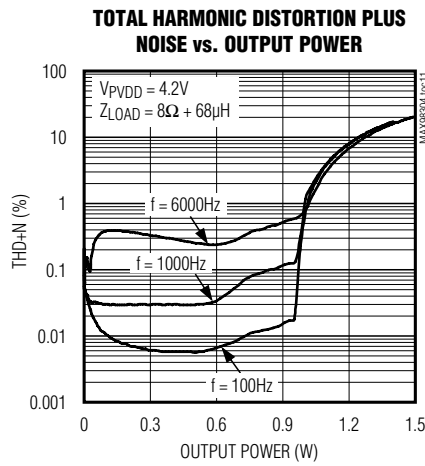
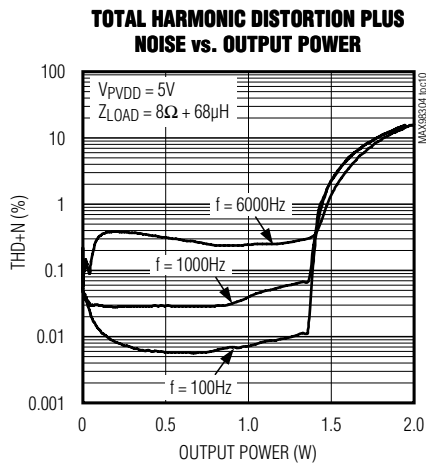

# MAX98304

## Mono 3.2W Class D Amplifier

### Typical Operating Characteristics (continued)

( $V_{PVDD} = V_{SHDN} = 5.0V$ ,  $V_{PGND} = 0V$ ,  $A_v = 6dB$ ,  $R_L = \infty$ ,  $R_L$  connected between  $OUT+$  to  $OUT-$ , AC measurement bandwidth 20Hz to 22kHz,  $T_A = +25^\circ C$ , unless otherwise noted.)

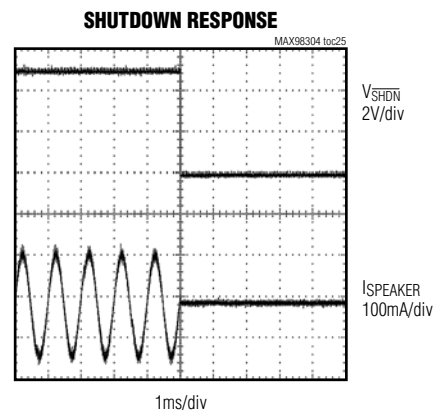
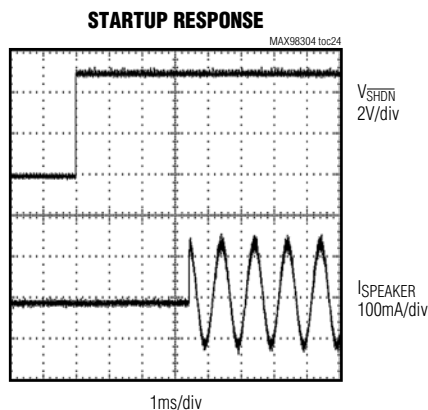
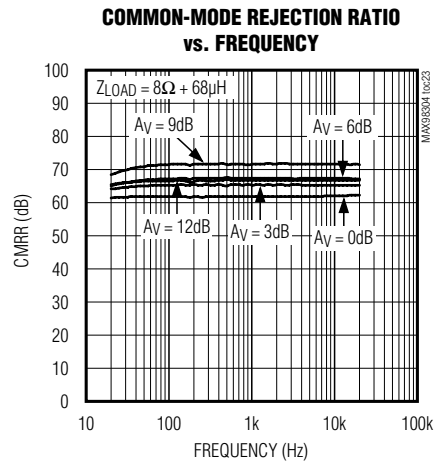
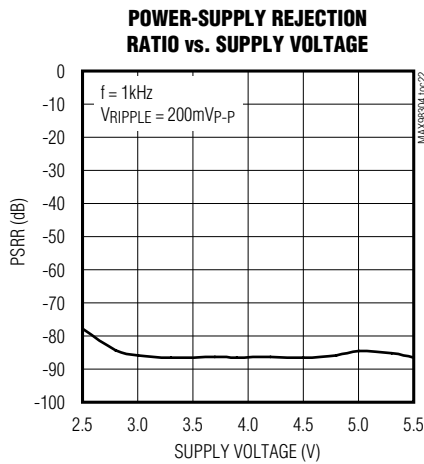
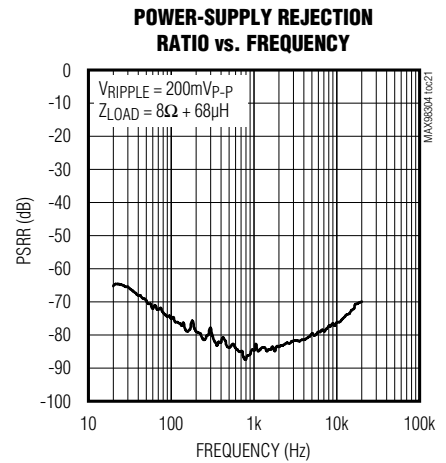
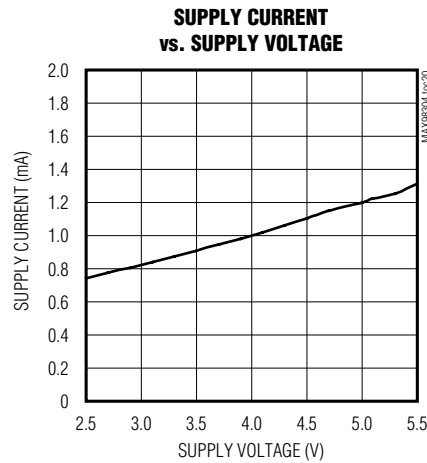
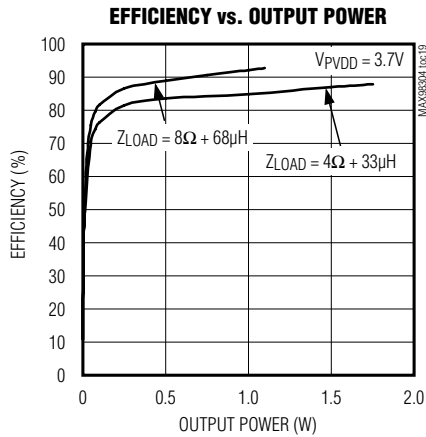

# MAX98304

## Mono 3.2W Class D Amplifier

### Typical Operating Characteristics (continued)

( $V_{PVDD} = V_{SHDN} = 5.0V$ ,  $V_{PGND} = 0V$ ,  $A_V = 6dB$ ,  $R_L = \infty$ ,  $R_L$  connected between  $OUT+$  to  $OUT-$ , AC measurement bandwidth 20Hz to 22kHz,  $T_A = +25^\circ C$ , unless otherwise noted.)

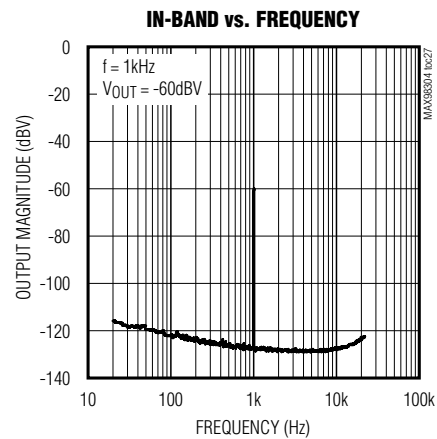
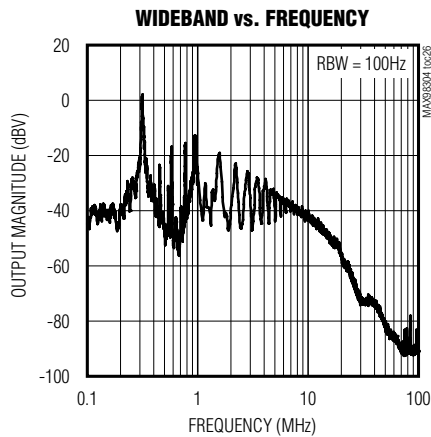

### Bump Configuration

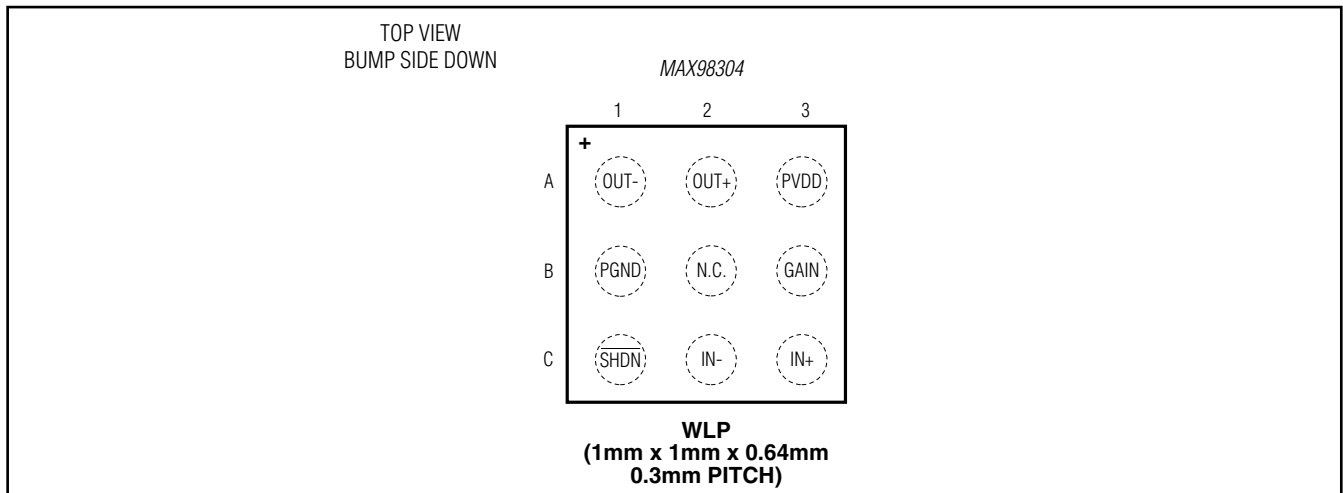

### Bump Description

| BUMP | NAME | FUNCTION   |
|------|------|--|
| A1   | OUT- | Negative Speaker Output  |
| A2   | OUT+ | Positive Speaker Output  |
| A3   | PVDD | Power Supply. Bypass PVDD to PGND with 0.1 $\mu$ F    10 $\mu$ F.          |
| B1   | PGND | Ground   |
| B2   | N.C. | No Connection. Can be left unconnected, or connected to PGND.              |
| B3   | GAIN | Gain Select. See Table 1 for GAIN settings.                                |
| C1   | SHDN | Active-Low Shutdown Input. Drive SHDN low to place the device in shutdown. |
| C2   | IN-  | Inverting Audio Input  |
| C3   | IN+  | Noninverting Audio Input   |

# MAX98304

## Mono 3.2W Class D Amplifier

### Detailed Description

The MAX98304 features low quiescent current, a low-power shutdown mode, comprehensive click-and-pop suppression, and excellent RF immunity.

The device offers Class AB audio performance with Class D efficiency in a minimal board-space solution.

The Class D amplifier features spread-spectrum modulation, edge-rate, and overshoot control circuitry that offers significant improvements to switch-mode amplifier radiated emissions.

The amplifier features click-and-pop suppression that reduces audible transients on startup and shutdown. The amplifier includes thermal overload and short-circuit protection.

### Class D Speaker Amplifier

The filterless Class D amplifier offers much higher efficiency than Class AB amplifiers. The high efficiency of a Class D amplifier is due to the switching operation of the output stage transistors. Any power loss associated with the Class D output stage is mostly due to the  $I^2R$  loss of the MOSFET on-resistance and quiescent current overhead.

### Ultra-Low EMI Filterless Output Stage

Traditional Class D amplifiers require the use of external LC filters, or shielding, to meet EN55022B electromagnetic-interference (EMI) regulation standards. Maxim's patented active emissions-limiting edge-rate control circuitry and spread-spectrum modulation reduces EMI emissions, while maintaining up to 93% efficiency.

Maxim's patented spread-spectrum modulation mode flattens wideband spectral components, while proprietary techniques ensure that the cycle-to-cycle variation of the switching period does not degrade audio reproduction or efficiency. The IC's spread-spectrum modulator randomly varies the switching frequency by  $\pm 12.5\text{kHz}$  around the center frequency (300kHz). Above 10MHz, the wideband spectrum looks like noise for EMI purposes (Figure 1).

### Speaker Current Limit

If the output current of the speaker amplifier exceeds the current limit (2.8A typ), the IC disables the outputs for approximately 100 $\mu\text{s}$ . At the end of 100 $\mu\text{s}$ , the outputs are reenabled. If the fault condition still exists, the IC continues to disable and reenable the outputs until the fault condition is removed.

### Selectable Gain

The IC offers five programmable gain selections through a single gain input (GAIN).

Table 1. Gain Control Configuration

| GAIN PIN   | MAXIMUM GAIN (dB) |
|--|-------------------|
| Connect to PGND  | 12                |
| Connect to PGND through 100k $\Omega$ $\pm 5\%$ resistor | 9                 |
| Connect to PVDD  | 6                 |
| Connect to PVDD through 100k $\Omega$ $\pm 5\%$ resistor | 3                 |
| Unconnected  | 0                 |

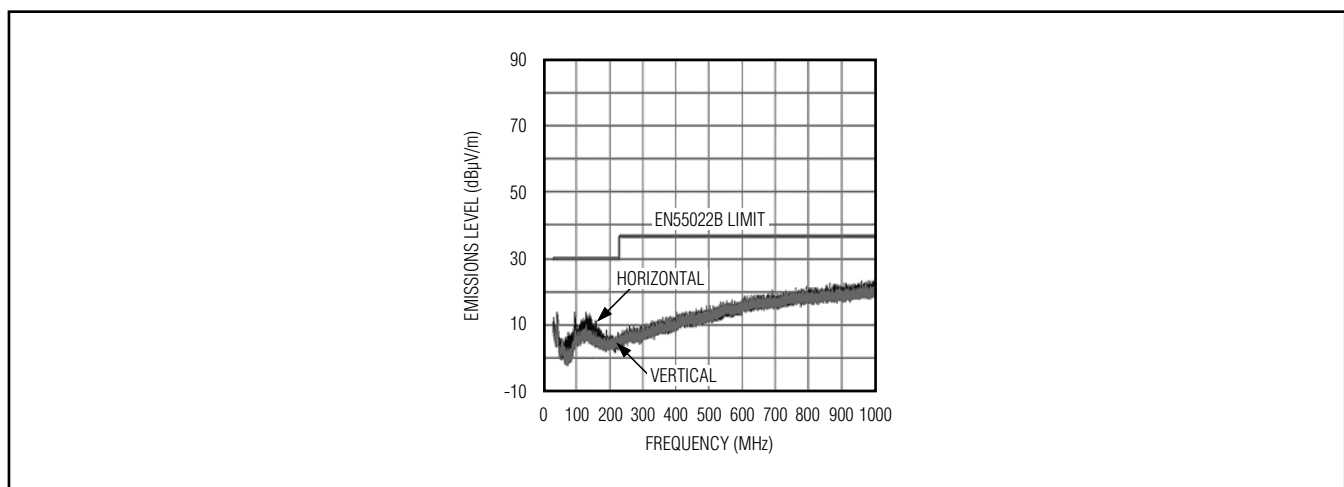

Figure 1. EMI with 60cm of Speaker Cable and No Output Filtering



## Mono 3.2W Class D Amplifier

### Shutdown

The IC features a low-power shutdown mode, drawing less than 0.1µA (typ) of supply current. Drive SHDN low to put the IC into shutdown.

### Click-and-Pop Suppression

The IC speaker amplifier features Maxim's comprehensive click-and-pop suppression. During startup, the click-and-pop suppression circuitry reduces any audible transient sources internal to the device. When entering shutdown, the differential speaker outputs ramp down to PGND quickly and simultaneously.

### Applications Information

#### Filterless Class D Operation

Traditional Class D amplifiers require an output filter. The filter adds cost, size, and decreases efficiency and THD+N performance. The IC's filterless modulation scheme does not require an output filter.

Because the switching frequency of the IC is well beyond the bandwidth of most speakers, voice coil movement due to the switching frequency is very small. Use a speaker with a series inductance > 10µH. Typical 8Ω speakers exhibit series inductances in the 20µH to 100µH range.

#### Component Selection

##### Power-Supply Input (PVDD)

PVDD powers the speaker amplifier. PVDD ranges from 2.5V to 5.5V. Bypass PVDD with a 0.1µF and 10µF capacitor to PGND. Apply additional bulk capacitance at the device if long input traces between PVDD and the power source are used.

##### Input Filtering

The input-coupling capacitor ( $C_{IN}$ ), in conjunction with the amplifier's internal input resistance ( $R_{IN}$ ), forms a high-pass filter that removes the DC bias from the incoming signal. These capacitors allow the amplifier to bias the signal to an optimum DC level.

Assuming zero source impedance  $C_{IN}$  is:

$$C_{IN} = \frac{2\pi \times R_{IN}}{f_{-3dB}} [\mu F]$$

where  $f_{-3dB}$  is the -3dB corner frequency and  $R_{IN}$  is the input resistance shown in the *Electrical Characteristics* table. Use capacitors with adequately low voltage-coefficient for best low-frequency THD performance.

### Layout and Grounding

Proper layout and grounding are essential for optimum performance. Good grounding improves audio performance and prevents switching noise from coupling into the audio signal.

Use wide, low-resistance output traces. As the load impedance decreases, the current drawn from the device increases. At higher current, the resistance of the output traces decreases the power delivered to the load. For example, if 2W is delivered from the device output to a 4Ω load through 100mΩ of total speaker trace, 1.904W is being delivered to the speaker. If power is delivered through 10mΩ of total speaker trace, 1.99W is being delivered to the speaker. Wide output, supply, and ground traces also improve the power dissipation of the device.

The IC is inherently designed for excellent RF immunity. For best performance, add ground fills around all signal traces on top or bottom PCB planes.

### WLP Applications Information

For the latest application details on WLP construction, dimensions, tape carrier information, PCB techniques, bump-pad layout, and recommended reflow temperature profile, as well as the latest information on reliability testing results, refer to Application Note 1891: *Wafer-level packaging (WLP) and its applications*. Figure 2 shows the dimensions of the WLP balls used on the IC.

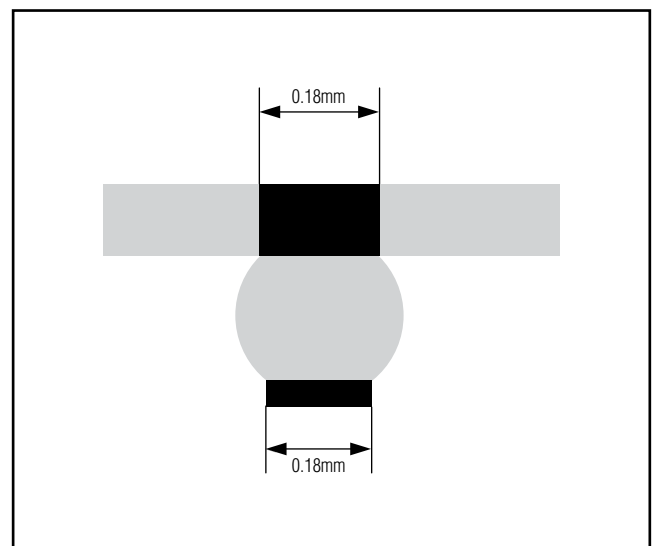
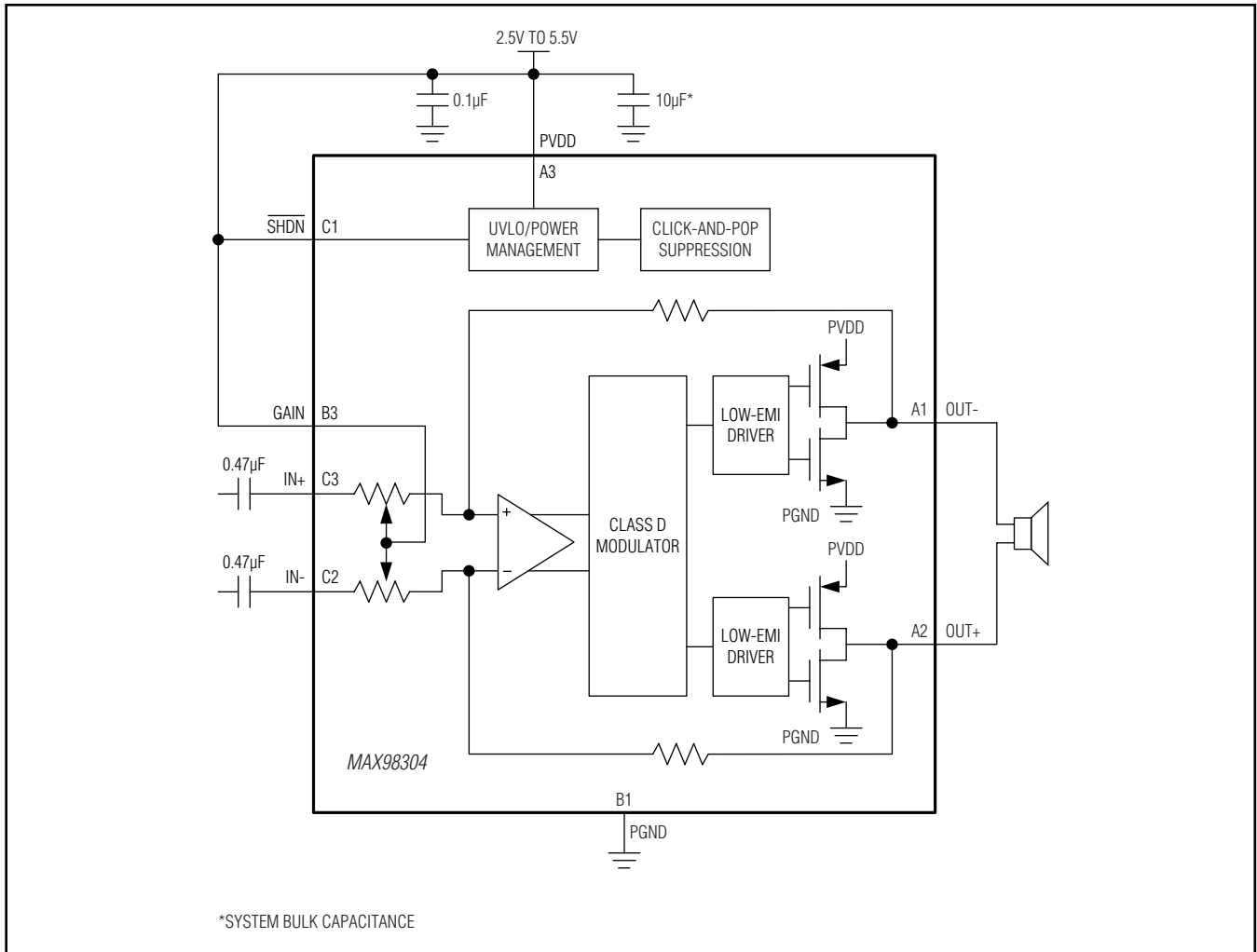

Figure 2. MAX98304 WLP Ball Dimensions

# MAX98304

## Mono 3.2W Class D Amplifier

### Functional Diagram



### Chip Information

PROCESS: CMOS

# MAX98304

## Mono 3.2W Class D Amplifier

### Package Information

For the latest package outline information and land patterns, go to [www.maximintegrated.com/packages](http://www.maximintegrated.com/packages). Note that a "+", "#", or "-" in the package code indicates RoHS status only. Package drawings may show a different suffix character, but the drawing pertains to the package regardless of RoHS status.

| PACKAGE TYPE | PACKAGE CODE | OUTLINE NO.             | LAND PATTERN NO. |
|--------------|--------------|-------------------------|------------------|
| 9 WLP        | W91D1+1      | <a href="#">21-0486</a> | —                |

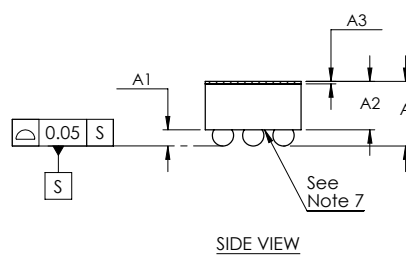
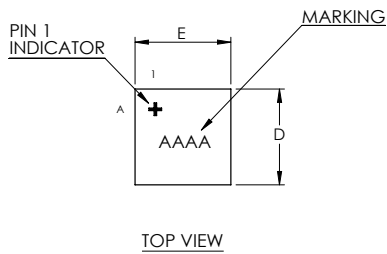

| COMMON DIMENSIONS |             |
|-------------------|-------------|
| A                 | 0.64 ±0.05  |
| A1                | 0.16 ±0.03  |
| A2                | 0.48 REF    |
| A3                | 0.025 BASIC |
| b                 | 0.21 ±0.03  |
| D1                | 0.60 BASIC  |
| E1                | 0.60 BASIC  |
| e                 | 0.30 BASIC  |
| SD                | 0.00 BASIC  |
| SE                | 0.00 BASIC  |

| PKG. CODE | E    |      | D    |      | DEPOPULATED BUMPS |
|-----------|------|------|------|------|-------------------|
|           | MIN  | MAX  | MIN  | MAX  |                   |
| W91D1+1   | 0.95 | 0.98 | 0.95 | 0.98 | NONE              |

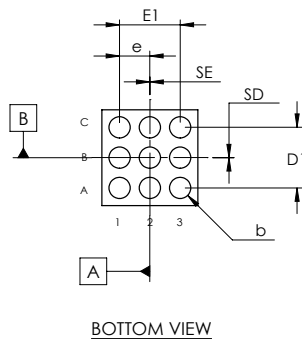

#### NOTES:

- Terminal pitch is defined by terminal center to center value.
- Outer dimension is defined by center lines between scribe lines.
- All dimensions in millimeter.
- Marking shown is for package orientation reference only.
- Tolerance is ± 0.02 unless specified otherwise.
- All dimensions apply to PbFree (+) package codes only.
- Front - side finish can be either Black or Clear.

-DRAWING NOT TO SCALE-

| TITLE  |                      |      |     |
|--|----------------------|------|-----|
| PACKAGE OUTLINE<br>9 BUMPS, WLP PKG. 0.3mm PITCH |                      |      |     |
| APPROVAL   | DOCUMENT CONTROL NO. | REV. | 1/1 |
|  | 21-0486              | B    |     |

# MAX98304

## Mono 3.2W Class D Amplifier

### Revision History

| REVISION NUMBER | REVISION DATE | DESCRIPTION     | PAGES CHANGED |
|-----------------|---------------|-----------------|---------------|
| 0               | 9/10          | Initial release | —             |



Maxim Integrated cannot assume responsibility for use of any circuitry other than circuitry entirely embodied in a Maxim Integrated product. No circuit patent licenses are implied. Maxim Integrated reserves the right to change the circuitry and specifications without notice at any time. The parametric values (min and max limits) shown in the Electrical Characteristics table are guaranteed. Other parametric values quoted in this data sheet are provided for guidance.