

Introduction

The ISL6537A, in conjunction with the ISL6506, provides a complete ACPI compliant power solution for computer systems with either dual channel DDR1, DDR2, or DDR3 Memory systems. The chipset offered by Intersil provides the necessary control, protection and proper ACPI sequencing of the following rails: 5VDUAL, 3.3VDUAL, VDDQ_DDR, VTT_DDR, VREF_DDR, VDAC, VGMCH, and VTT_GMCH/CPU.

The ISL6537A consists of a synchronous buck controller to supply VDDQ_DDR with high current during S0/S1 (Run) states and standby current during S3 (Suspend-To-RAM = STR) state. During Run mode, a fully integrated sink-source regulator generates an accurate (VDDQ_DDR/2) high current VTT_DDR voltage. A buffered version of the VDDQ_DDR/2 reference is provided as VREF_DDR. The ISL6537A also features a PWM controller that, in conjunction with an external gate driver IC, regulates VGMCH and two LDO controllers to regulate VDAC and VTT_GMCH/CPU. A more complete description of the ISL6537A can be found in the datasheet[1].

The ISL6506 controls the 5VDUAL and 3.3VDUAL rails. There are three versions of the ISL6506. The version required will depend on whether 5VDUAL is required to be active during S4/S5. A more complete description of the ISL6506 can be found in the datasheet[2].

Quick Start Evaluation

The ISL6537A_6506EVAL1Z board is shipped 'ready to use' right from the box. The ISL6537A_6506EVAL1Z supports testing with an ATX power supply. All seven outputs can be exercised through external loads. Both the VDDQ and VTT regulators have the ability to source or sink current while all other outputs may only source current.

There are posts available on each regulated output rail for drawing a load and/or monitoring the voltages. Eighteen individually labeled probe points are also available for use. These probe points provide Kelvin connections to signals which may be of interest to the designer.

Two switches have been placed on the board to accommodate ACPI signal simulation. These two switches generate the SLP_S3 and SLP_S5 signals that are sent to the ISL6506, ISL6537A and the ATX.

Recommended Test Equipment

To test the full functionality of the ISL6537A and ISL6506, the following equipment is recommended:

- An ATX power supply (minimum 160W configuration)
- Multiple electronic loads
- Four channel oscilloscope with probes
- Precision digital multimeters

As there are seven regulated rails, it is difficult to exercise and monitor all of them at the same time. The user may wish to employ discrete resistive loads in addition to electronic loads. Electronic loads are favored because they allow the user to apply a multitude of varying load levels and load transients which allow for a broader analysis.

Circuit Setup

SET SWITCHES

Ensure that the S3 switch is in the ACTIVE position and the S5 switch is in the S5 position. With the switches in these positions, the board will be forced into a sleep state at initial power up.

CONNECT THE ATX SUPPLY

Plug the 20-pin connector from the ATX power supply into the 20-pin receptacle, J1, on the evaluation board. Should the ATX power supply have a master AC switch, turn this switch to the OFF position prior to applying AC voltage.

CONNECT LOADS

Figure 1 details the locations of the available power, ground, and signal connection points on the ISL6537A_6506EVAL1Z evaluation board. The maximum loads specified for each rail below are absolute. VTT_DDR is cascaded from the VDDQ_DDR rail while the VTT_GMCH/CPU is cascaded from the VGMCH rail (refer to "ISL6537A_6506EVAL1Z Schematic" on page 10). Any loading of a cascaded rail will itself be a load on the rail that is providing input and must be accounted for prior to application of loads.

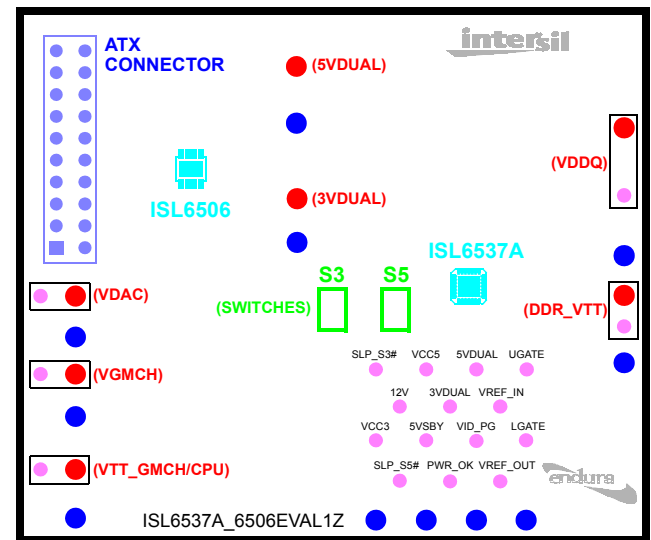

- KEY**
- - Ground Terminal for Load and/or Probe Ground Clip
 - - Output Rail Terminal for Load and/or Probe
 - - Probe Point

FIGURE 1. ISL6537A_6506EVAL1Z BOARD POWER AND SIGNAL CONNECTIONS

Loading V_{DDQ_DDR} - Sourcing Current: Connect the positive terminal of an electronic load to the V_{DDQ} post. Connect the return terminal of the same load to the corresponding GND post. The maximum load current that the rail will support prior to entering an overcurrent condition is 15A.

Loading V_{DDQ_DDR} - Sinking Current: Typically, the V_{DDQ} rail does not sink current, however, the ISL6537A has the ability to allow the V_{DDQ} rail to do just that. To test the V_{DDQ} rail while sinking current, connect the positive terminal of an electronic load to the 5VDUAL post. Connect the return terminal of the same load to the V_{DDQ} post. The maximum load current that the rail will support prior to entering an overcurrent condition is 15A.

CAUTION: The return terminal of the load must float for this to work properly.

Loading V_{TT_DDR} - Sourcing Current: To test V_{TT_DDR} while the regulator sources current, connect the positive terminal of an electronic load to the DDR_VTT post. Connect the return terminal of the same load to the corresponding GND post. The maximum continuous current that the rail will support is 2A. Transient loads to 3A are also supported.

Loading V_{TT_DDR} - Sinking Current: To test V_{TT_DDR} while the regulator sinks current, connect the positive terminal of an electronic load to the V_{DDQ} post. Connect the return terminal of the same load to the DDR_VTT post. The maximum continuous current that the rail will support is 2A. Transient loads to 3A are also supported.

CAUTION: The return terminal of the load must float for this to work properly.

Loading V_{GMCH}: Connect the positive terminal of an electronic load to the V_{GMCH} post. Connect the return terminal of the corresponding GND post. The maximum load supported by this rail is 10A.

Loading V_{DAC}: Connect the positive terminal of an electronic load to the V_{DAC} post. Connect the return terminal of the corresponding GND post. The maximum load supported by this rail is 5A.

Loading V_{TT_GMCH/CPU} - Sourcing Current: Connect the positive terminal an electronic load to the VTT_GMCH/CPU post. Connect the return terminal of the corresponding GND post. The maximum load supported by this rail is 5A.

Loading 5VDUAL: Connect the positive terminal of an electronic load to the 5VDUAL post. Connect the return terminal of the corresponding GND post. The maximum load supported by this rail is 14A.

Loading 3VDUAL: Connect the positive terminal of an electronic load to the 3VDUAL post. Connect the return terminal of the corresponding GND post. The maximum load supported by this rail is 14A.

Operation

APPLY POWER TO THE BOARD

Plug the ATX supply into the mains. If the supply has an AC switch, turn it on. With the S3 and S5 switches in the ACTIVE and S5 positions, respectively, the board will be in the S5 sleep state. Voltages present on the board will be 5VSBY which is supplied by the ATX and 3VDUAL which is controlled by the ISL6506.

To enable the circuit, toggle the S5 switch to ACTIVE. This will place the board in the S0 state. All outputs should be brought up.

EXAMINE START-UP WAVEFORMS AND OUTPUT QUALITY UNDER VARYING LOADS

Start-up is immediate following the transition to the S0 state. Using an oscilloscope or other laboratory equipment, the ramp-up and/or regulation of the outputs can be studied. Loading of the output can be accomplished through the use of an electronic load. Other methods, such as the use of discrete power resistors will work for loading as well.

Reference Design

General

The ISL6537A_6506EVAL1Z is an evaluation board that highlights the operation of the ISL6537A and ISL6506 in an embedded ACPI and DDR DRAM Memory Power application. The V_{DDQ_DDR} supply has been designed to supply 1.8V at a maximum load of 15A. The V_{TT_DDR} termination supply will track the V_{DDQ_DDR} supply at 50% while sourcing or sinking current. The second PWM controller is designed to supply up to 10A of current at 1.5V for V_{GMCH} while the single stage LDOs supply 2.5V for V_{DAC} and 1.2V for V_{TT_GMCH/CPU}. Refer to "ISL6537A_6506EVAL1Z Schematic" on page 10, "ISL6537A_6506EVAL1Z Bill of Material" on page 11 and "ISL6537A_6506EVAL1Z Layout" on page 12).

Power Up And State Transitions

Sleep State Transitions

There are several distinct state transitions that the ISL6537A and ISL6506 support. These include a Cold/Mechanical Start (S5 to S0 state transition), Active to Sleep (S0 to S3 transition), Sleep to Active (S3 to S0 transition) and finally Active to Shutdown (S0 to S5 transition). Table 1 shows the switch positions and the corresponding ACPI states.

TABLE 1. ISL6537A_6506EVAL1Z STATES

S3 SWITCH	S5 SWITCH	SLEEP STATE	ATX STATE
ACTIVE	ACTIVE	S0 (Active)	ON
S3	ACTIVE	S3	Standby
ACTIVE	S5	S5	Standby
S3	S5	S5	Standby

If both the S3 and S5 switches are thrown to S3 and S5, respectively, the board will default to an S5 state. If the board is in either an S3 or S5 sleep state, the ATX supply is put into standby mode, where only the 5VSBY rail is active.

Initial Power Up - Cold Start

If both the S3 and S5 switches are toggled to the ACTIVE position prior to applying AC power to the ATX supply, the board will immediately enter into S0 state when the 5VSBY rail comes up after the AC power is applied to the ATX. Figure 2 shows a Cold Start. Examination of the V_{DAC}

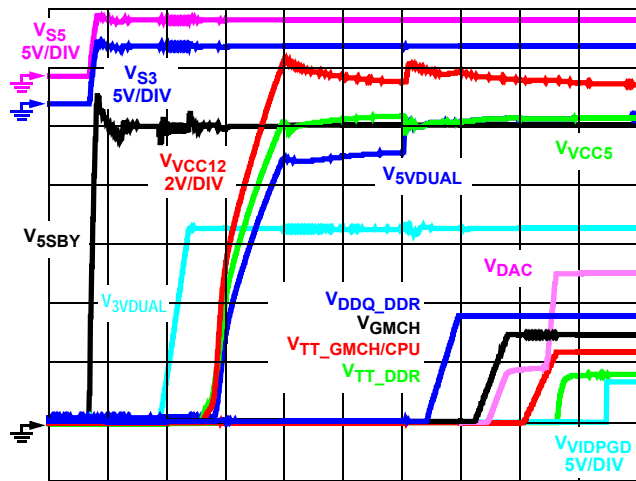

TIMEBASE: 10ms/DIV
NOTE: ALL SIGNALS at 1V/DIV UNLESS OTHERWISE STATED
FIGURE 2. COLD/MECHANICAL START

waveform shows this rail ramping up with the V_{GMCH} rail. This is due to an external circuit that was included on the evaluation board and is described in the section titled "Grantsdale VDAC Sequencing Circuitry" on page 5.

S5 Sleep State to S0 State Transition

If the S5 switch is toggled to the S5 position prior to application of AC power to the ATX supply, then the board will immediately enter into the S5 sleep state when the 5VSBY rail comes up after the AC voltage is applied to the ATX. The ISL6506 will bring up the 3VDUAL rail but all other output rails will be inactive. The transition from the S5 state to the S0 state will occur when the S5 switch is toggled to the ACTIVE position. Figure 3 shows this transition. Note that the 3VDUAL rail are already active prior to the other rails soft starting. If the ISL6506A had been used, the 5VDUAL rail would have been active in the S5 state as well. During testing of the evaluation board, it may be observed that the 5VDUAL rail stays up during the S5 sleep state. If this behavior is observed, the explanation would be that the bulk capacitor on the 5VDUAL rail did not discharge a significant amount while the board was in the S5 sleep state.

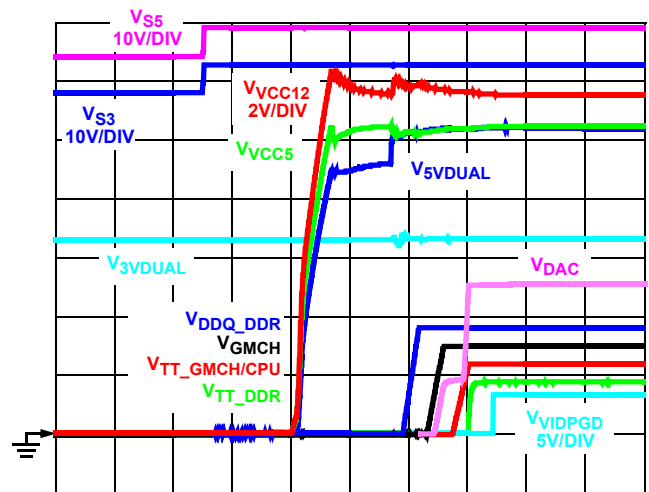

TIMEBASE: 20ms/DIV
NOTE: ALL SIGNALS AT 1V/DIV UNLESS OTHERWISE STATED

FIGURE 3. S5 to S0 STATE TRANSITION

S0 to S3 Sleep State Transition

Figure 4 shows the transition from the S0 state to the S3 sleep state. To achieve this transition, switch S3 is toggled to the S3 position. When transitioning from the S0 state to the S3 sleep state, it is important that the load on the V_{DDQ_DDR} rail be reduced to levels that the 5VDUAL rail is capable of supporting. If the load on V_{DDQ_DDR} is excessive, V_{DDQ_DDR} voltage will collapse.

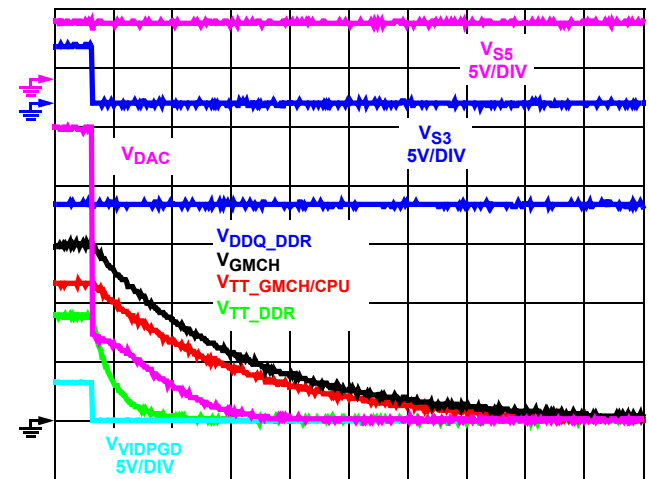

TIMEBASE: 100ms/DIV
NOTE: ALL SIGNALS AT 500mV/DIV UNLESS OTHERWISE STATED

FIGURE 4. S0 TO S3 STATE TRANSITION

S3 to S0 State Transition

Figure 5 shows the transition from the S3 sleep state to the S0 state. This transition is accomplished by returning the S3 switch to the ACTIVE position. Once the PGOOD signal has been asserted, the V_{DDQ_DDR} rail can then be loaded beyond the S3 load limitations of 5VDUAL.

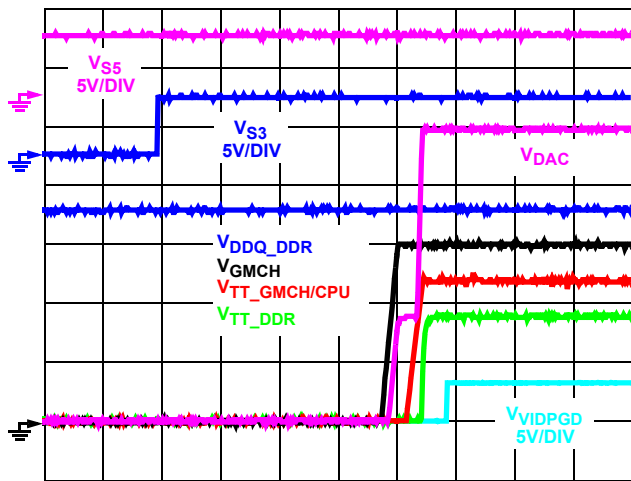

TIMEBASE: 20ms/DIV

NOTE: ALL SIGNALS AT 500mV/DIV UNLESS OTHERWISE STATED
FIGURE 5. S3 TO S0 STATE TRANSITION

ACPI Start-up Timing

The ISL6506 and ISL6537A chipset were designed to work in tandem to Start-up critical ACPI and Memory voltages within a specific window of opportunity during the overall Start-up or sleep recovery process of a typical motherboard. Figure 6 shows a generic desktop sleep state to wake state sequencing. At time T1, either the SLP_S3# or SLP_S5#

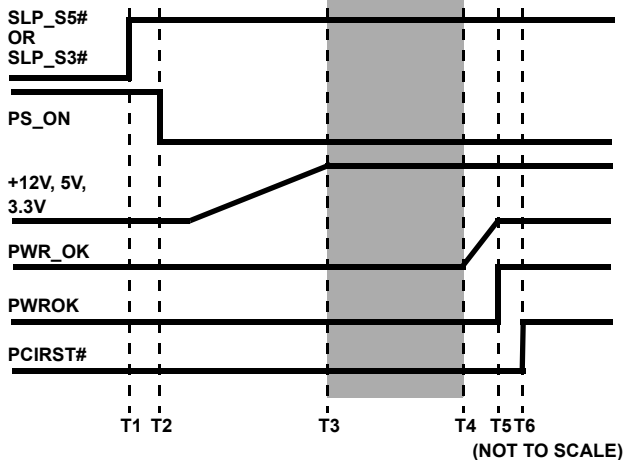

FIGURE 6. GENERIC WAKEUP SEQUENCING (NOT TO SCALE)

signal transitions HIGH, which is the signal to the system to enter into the S0 state. At time T2, 10ns later, PS_ON, the signal that commands the ATX supply to turn on, is forced LOW. At time T3, the ATX rails have risen to 95% of their targeted nominal levels. The time between T2 and T3 can be between 100ms and 500ms. At time T4, the PWR_OK signal from the ATX supply starts to rise. The time between T3 and T4 will also fall between 100ms and 500ms. At time T5, the ATX PWR_OK signal has risen HIGH. This transition is specified to be less than 10ms. At this point, the PWROK signal from the GMCH is commanded HIGH. At time T6, anywhere from 31 to 44 RTCs after PWROK has asserted HIGH, the PCIRST# signal from the ICH asserts HIGH.

When PCIRST# asserts HIGH, bus traffic resumes and the system is awake.

The ISL6506 and ISL6537A chipset bring all the ACPI rails under their control into regulation between time T3 and T4. This timing assures, even with minimum specified system timings, that the regulators will have their inputs available from the ATX supply and also that the output rails will be in regulation and ready for bus traffic once PCIRST# asserts HIGH.[4][5]

Evaluation Board Design

The complete Bill of Material for the evaluation board can be seen in "ISL6537A_6506EVAL1Z Bill of Material" on page 11. This section gives an overview of the design parameters and decisions made for each regulator.

ISL6506 Circuitry

The ISL6506 incorporates all the ACPI timing, control and monitoring required for the 5VDUAL and 3.3VDUAL rails, while maintaining a low component count. The Vishay Si7840 was utilized for both N-Channel MOSFET pass elements due to the low $r_{DS(ON)}$ and thermal capabilities of the packaging. Very little power is dissipated from the MOSFET in this application. The P-Channel MOSFET, the Vishay Si7483, was chosen for similar reasons.

The MOSFET thermal capabilities and its $r_{DS(ON)}$ are the two major considerations when choosing a MOSFET as a pass element for the 5VDUAL and 3.3VDUAL rails. The maximum allowable temperature rise of the MOSFET is used to calculate the maximum power that the MOSFET can dissipate via the thermal resistance ratings of the FET. The maximum $r_{DS(ON)}$ of the MOSFET can then be calculated by dividing the maximum allowable power dissipation of the MOSFET by the square of the maximum load current that will flow through the MOSFET. If the datasheet specified $r_{DS(ON)}$ of the MOSFET being considered is less than this calculated maximum $r_{DS(ON)}$ value, then the MOSFET can be used safely in the application, provided proper layout techniques for thermal dissipation are used.

ISL6537A Circuitry

VDDQ_DDR Switching Regulator

The VDDQ_DDR switching regulator was designed to handle a 15A continuous output load while maintaining 1.8V. Voltage excursions due to transient loading of 25A/ μ s were to be no greater than 50mV with a full 15A load step.

In order to supply 15A of continuous current, two upper and two lower MOSFETs were utilized. The part chosen for both upper and lower MOSFETs was the Vishay Si7840BDP. The choice of both the MOSFET and the parallel MOSFET configuration will actually allow for a continuous current of at least 20A without the FETs becoming too hot.

The transient specifications were met by employing large value capacitors that have relatively low ESR ratings and by

using some ceramic capacitors to decrease the effective ESR even more. Three 1800 μ F bulk capacitors with 16m Ω ESR were utilized as the bulk output capacitance. During a transient, the large capacitance supplies energy to the load while the output inductor current slews up to match the load current.

The output inductor was designed so that the ripple voltage on the output rail would be approximately 20mV. A simple wirewound toroidal inductor was designed for this regulator. To save on the Bill of Material (BoM) cost, the same inductor was used on the input filter to the V_{DDQ} regulator.

Since there is an input inductor, the input capacitors must be rated to handle all of the AC RMS current going through the upper MOSFET. The capacitors that were chosen have RMS current ratings that exceed the maximum RMS current expected at full load.

The final aspect to the V_{DDQ_DDR} regulator design was to insure the stability of the system. A Type III compensation network was chosen for this design. The compensation components were calculated to give a system bandwidth of about 50kHz with a Phase Margin of approximately 65°. For more information on calculating the compensation components for a single phase buck regulator, see Intersil's Technical Brief, TB417, titled "Designing Stable Compensation Networks for Single Phase Voltage Mode Buck Regulators." [3]

V_{GMCH} SWITCHING REGULATOR

The regulation of the V_{GMCH} rail is accomplished by down converting from the 3.3VATX rail with a switching regulator. The ISL6537A incorporates all the control aspects of the switching regulator and requires that a MOSFET gate driver be utilized to drive the upper and lower MOSFETs of the synchronous buck switching regulator. This design utilizes the ISL6613 to drive the switching MOSFETs. The MOSFETs chosen were dual packaged FETs from Vishay, the Si7844. The FETs and the package allow for efficient regulation at full load of 10A. The output inductor is the same as the input and output inductor used in the V_{DDQ} regulator. The output capacitor allows for a large amount of capacitance while minimizing the output ripple to less than 40mV. The compensation network is a Type III. This network yields a stable system with approximately 30kHz of bandwidth.

LDO REGULATORS

The V_{TT_DDR} regulator required minimal design work as the control circuitry and pass element are incorporated within the ISL6537A. Except for the pass element and output capacitance, all other circuitry for the remaining LDOs is also contained within the ISL6537A.

The V_{DAC} and $V_{TT_GMCH/CPU}$ are both regulated via the internal LDO controllers. The pass elements chosen for both was the Vishay Si7840BDP. This allowed for a higher single

part count on the BoM while allowing the regulators to source a sufficient amount of load.

For all the LDOs, including the V_{TT_DDR} regulator, the output capacitance was chosen to maintain a stable output rail while minimizing voltage excursions due to load transients.

GRANTS DALE VD AC SEQUENCING CIRCUITRY

The Grantsdale chipset imposes special requirements on the startup and shutdown timing of the V_{DAC} rail in relation to the V_{GMCH} rail. During Start-up, the V_{DAC} rail must not Start-up until the V_{GMCH} rail has reached at least 0.7V. When entering a sleep state, the V_{DAC} rail must be brought below the V_{GMCH} rail level before the V_{GMCH} rail can begin to ramp down.

A circuit was included on the ISL6537A evaluation board that will keep a 0.7V differential between the V_{GMCH} and V_{DAC} rails until the V_{DAC} rail is soft started. This circuit will also discharge the V_{DAC} rail immediately upon entering into a sleep state. This circuit is shown in Figure 7. During Start-up, the base-emitter junction of Q302 maintains a 0.7V differential between V_{GMCH} and V_{DAC} . Upon assertion of the SLP_S3# signal, Q303 discharges the V_{DAC} rail which allows the V_{GMCH} rail to discharge.

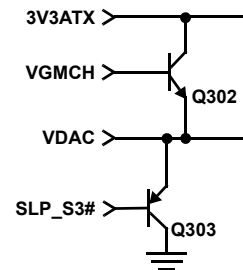

FIGURE 7. GRANTS DALE SEQUENCING CIRCUITRY

Evaluation Board Performance

This section presents the performance of the ISL6537A_6506EVAL1Z evaluation board while subjected to various conditions.

Switching Regulator Ripple Voltages

Figure 8 shows the ripple voltage on the V_{DDQ} and V_{GMCH} outputs.

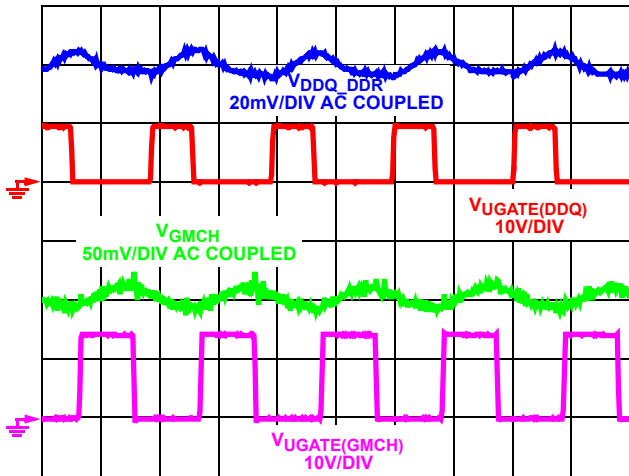

TIMEBASE: 1ms/DIV
FIGURE 8. V_{DDQ} and V_{GMCH} RIPPLE VOLTAGE

Transient Performance

Figures 9 through 14 show the response of the outputs when subjected to a variety of transient loads while in the Active (S0) State. Figure 9 shows V_{DDQ}_DDR under transient

loading. The response of the V_{DDQ}_DDR regulator to the transient load brings the output voltage back into regulation very quickly.

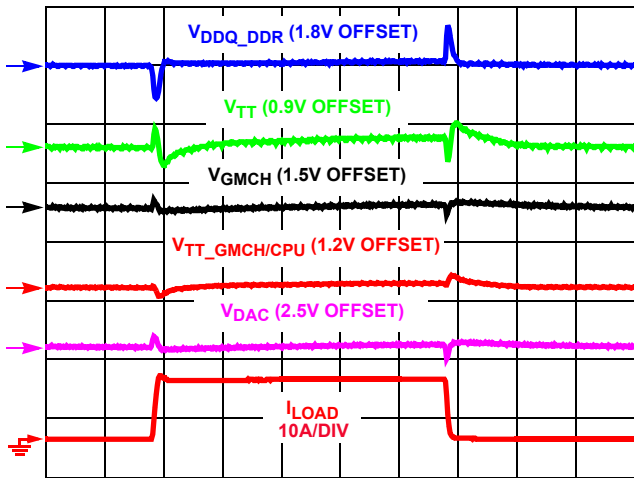

TIMEBASE: 200ms/DIV
 NOTE: ALL SIGNALS AT 50mV/DIV UNLESS OTHERWISE STATED
FIGURE 9. TRANSIENT ON V_{DDQ}

Figure 10 shows V_{TT}_DDR under a transient loading that causes V_{TT}_DDR to source current.

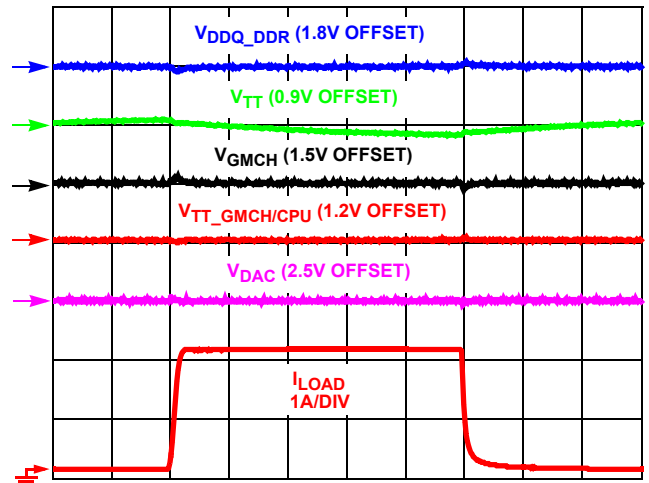

TIMEBASE: 200ms/DIV
 NOTE: ALL SIGNALS AT 50mV/DIV UNLESS OTHERWISE STATED
FIGURE 10. SOURCING TRANSIENT ON V_{TT}_DDR

While the load is being applied to the V_{TT}_DDR rail, there is a noticeable reaction in the V_{DDQ}_DDR rail as well. Since the V_{TT}_DDR rail is derived from the V_{DDQ}_DDR rail, any load on the V_{TT}_DDR rail is seen by the V_{DDQ}_DDR rail.

Figure 11 shows V_{TT}_DDR under a transient that causes V_{TT}_DDR to sink current.

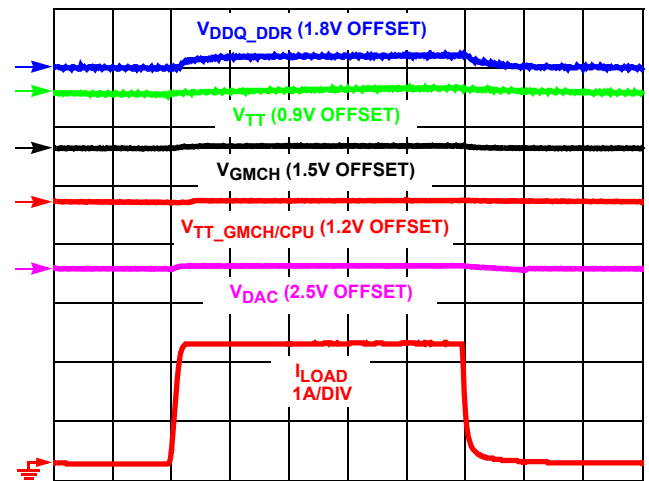

TIMEBASE: 200ms/DIV
 NOTE: ALL SIGNALS AT 50mV/DIV UNLESS OTHERWISE STATED
FIGURE 11. SINKING TRANSIENT ON V_{TT}_DDR

Again, the reaction of the V_{DDQ}_DDR rail is evident since the loading on the V_{TT}_DDR rail is transferred directly to the V_{DDQ}_DDR rail. In both cases, sourcing and sinking current, where the V_{TT}_DDR rail has been loaded and the V_{DDQ}_DDR rail has responded to the loading, the V_{TT}_DDR rail did not appear to be affected as much as the V_{DDQ}_DDR rail. This is because a linear regulator (V_{TT}_DDR) will respond much faster than a switching regulator (V_{DDQ}_DDR). This difference in response is because the

inductor current must slew up/down to supply the load current while the linear regulator control will apply more voltage to the gate of the pass FET.

Figure 12 shows V_{GMCH} under transient loading.

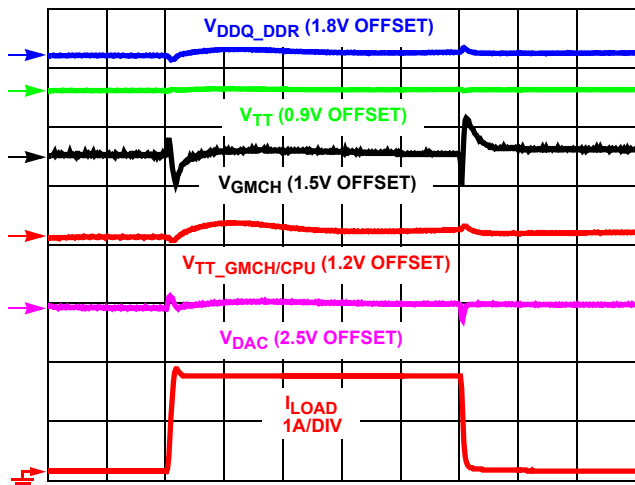

TIMEBASE: 200ms/DIV

NOTE: ALL SIGNALS AT 50mV/DIV UNLESS OTHERWISE STATED

FIGURE 12. TRANSIENT ON V_{GMCH}

The response of the V_{GMCH} regulator to the transient load brings the output voltage back into regulation very quickly. The $V_{TT_GMCH/CPU}$ rail is affected by the transient on the V_{GMCH} rail since it is derived from the V_{GMCH} rail.

Figure 13 shows the $V_{TT_GMCH/CPU}$ rail under a sourcing transient load.

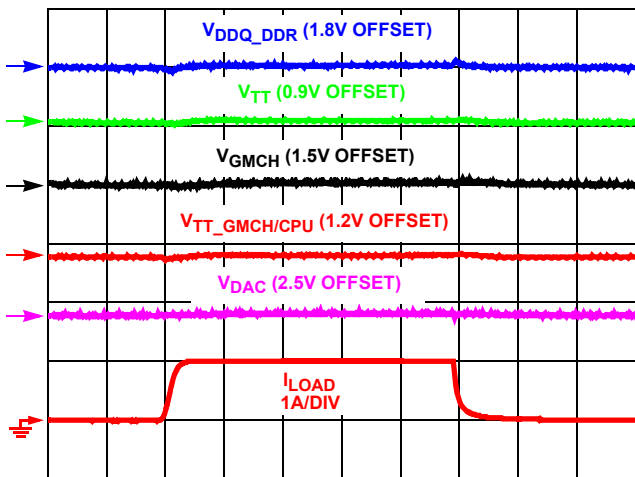

TIMEBASE: 200ms/DIV

NOTE: ALL SIGNALS AT 50mV/DIV UNLESS OTHERWISE STATED

FIGURE 13. SOURCING TRANSIENT ON $V_{TT_GMCH/CPU}$

The loading of this rail is light enough such that the response of the V_{GMCH} rail is negligible.

Figure 14 shows the V_{DAC} rail under transient loading.

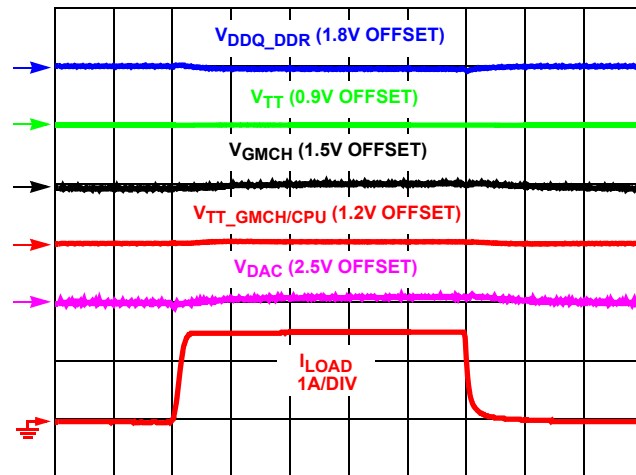

TIMEBASE: 200ms/DIV

NOTE: ALL SIGNALS AT 50mV/DIV UNLESS OTHERWISE STATED

FIGURE 14. TRANSIENT ON V_{DAC}

Fault Protection

Figures 15, 16, 17, 18 and 19 show the response of the system to a shorts on the V_{DDQ_DDR} rail, V_{TT} rail, V_{GMCH} rail, $V_{TT_GMCH/CPU}$ rail and V_{DAC} rail, respectively.

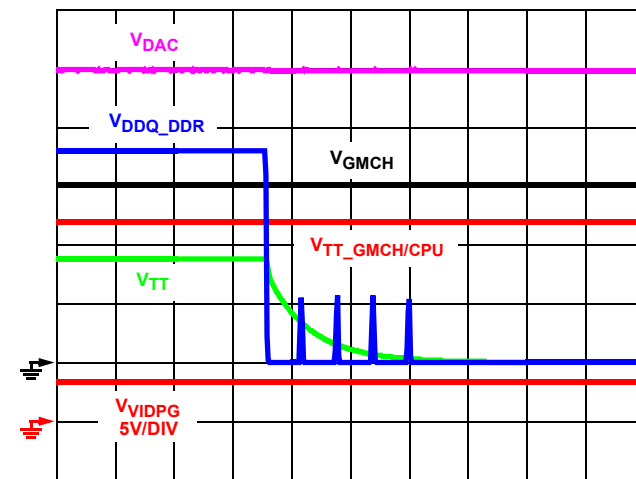

TIMEBASE: 50ms/DIV

NOTE: ALL SIGNALS AT 50mV/DIV UNLESS OTHERWISE STATED
100Ω LOAD ON ALL RAILS

FIGURE 15. FAULT RESPONSE ON V_{DDQ}

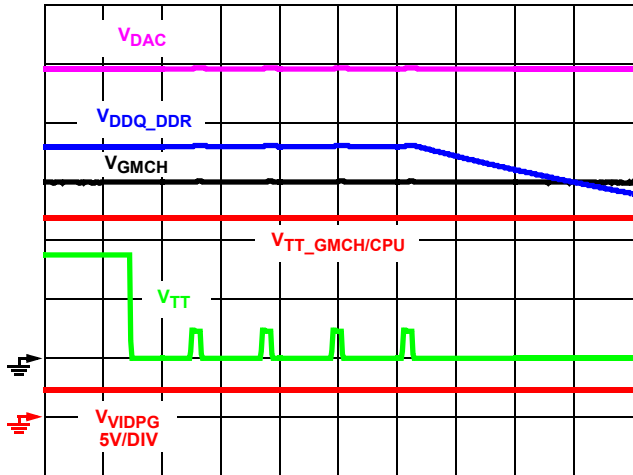

TIMEBASE: 50ms/DIV

NOTE: ALL SIGNALS AT 500mV/DIV UNLESS OTHERWISE STATED
100Ω LOAD ON ALL RAILS

FIGURE 16. FAULT RESPONSE ON VTT

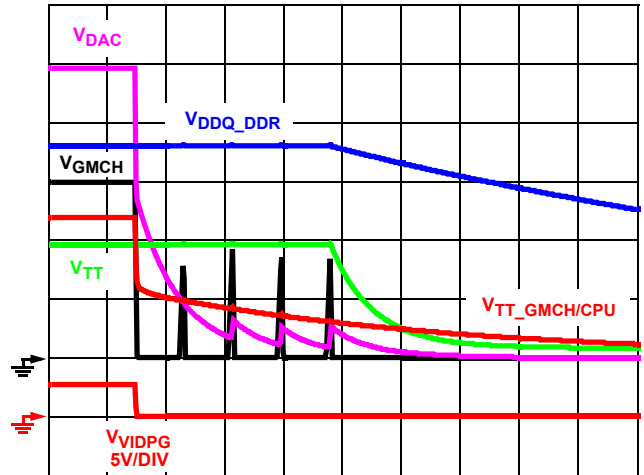

TIMEBASE: 50ms/DIV

NOTE: ALL SIGNALS AT 500mV/DIV UNLESS OTHERWISE STATED
100Ω LOAD ON ALL RAILS

FIGURE 17. FAULT RESPONSE ON VGMCH

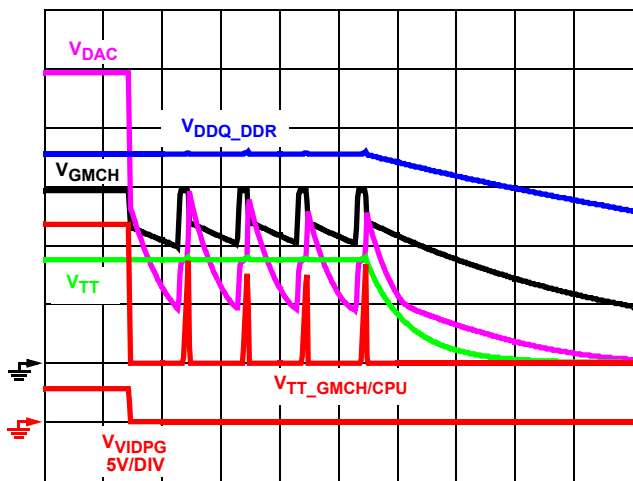

TIMEBASE: 50ms/DIV

NOTE: ALL SIGNALS AT 500mV/DIV UNLESS OTHERWISE STATED
100Ω LOAD ON ALL RAILS

FIGURE 18. FAULT RESPONSE ON VTT_GMCH/CPU

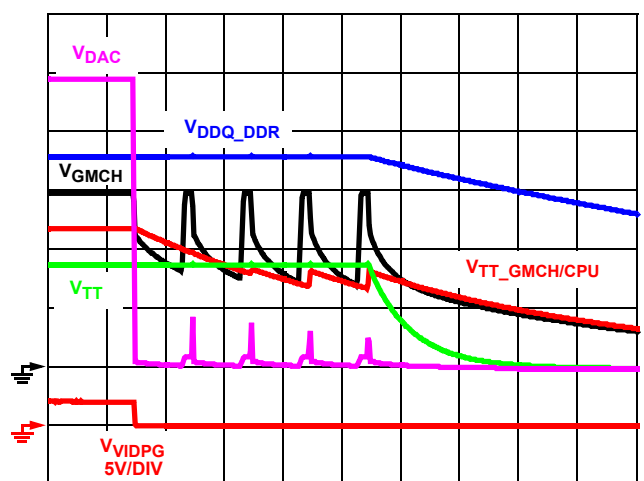

TIMEBASE: 50ms/DIV

NOTE: ALL SIGNALS AT 500mV/DIV UNLESS OTHERWISE STATED
100Ω LOAD ON ALL RAILS

FIGURE 19. FAULT RESPONSE ON VDAC

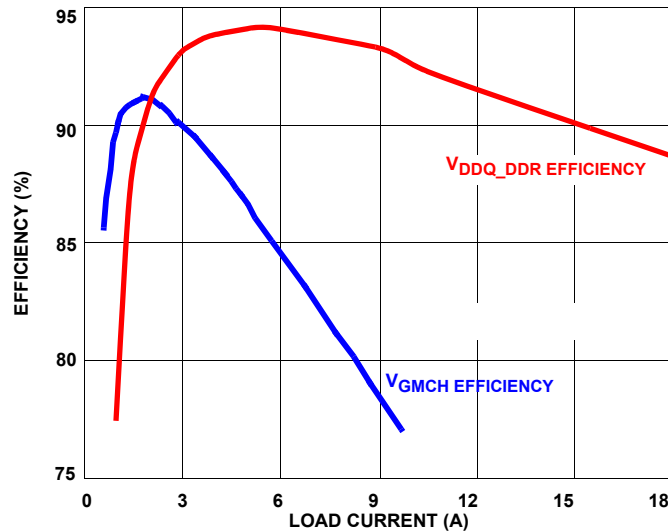

FIGURE 20. SWITCHING REGULATOR EFFICIENCIES

Efficiency

Figure 20 shows the efficiencies of the V_{DDQ}_DDR and the V_{GMCH} switching regulators while in the S0 State. Measurements were taken at room temperature under thermal equilibrium with no air flow. As the other regulated outputs are all derived through linear regulation, their efficiencies are not shown.

ISL6537A_6506EVAL1Z Customization

There are numerous ways in which a designer might modify the ISL6537A_6506EVAL1Z evaluation board for differing requirements. Some of the changes which are possible include:

- The input and output inductors, L200 and L201, for the V_{DDQ}_DDR regulator as well as the output inductor, L302, for the V_{GMCH} regulator.
- The input and output capacitance for any of the regulators.
- The overcurrent trip point of the V_{DDQ}_DDR regulator, programmed through the OCSET resistor, R200. Refer to the ISL6537A datasheet for details on this.
- Changing the value of C104 to alter the soft start profile of the V_{TT}_DDR rail when transitioning from Sleep to Active State.
- All MOSFET footprints on the evaluation board allow for either SO8 or PowerPak packaged MOSFETs to be utilized.
- ISL6506 control can be bypassed by placing zero ohm jumpers at locations R15 and R18. Doing this will short out the NFETs that control the 3VDUAL and 5VDUAL rails.
- The output voltage of any regulator, except for V_{TT}_DDR may be modified by changing the voltage programming resistor for the respective regulator. For V_{DDQ}_DDR, change R204; for V_{GMCH}, change R303; for V_{DAC}, change R302; V_{TT}_GMCH/CPU, change R401. If the voltage level is to be modified, always change the resistor that is tied between the feedback point of the error amplifier and ground. Modifying

the value of the resistor that is located between the output and the feedback point on the error amplifier will alter the system response characteristics. Refer to the ISL6537A datasheet section titled "Output Voltage Selection" [1] for the equations used to select the resistor values discussed above.

- The effect of the S3# and S5# signals on the ATX power supply can be negated by populating resistor Rx11 with a zero ohm jumper. Doing this will cause the PSON# signal to the ATX supply to be hard tied to ground. This will force the ATX supply on even in sleep states.

Conclusion

The ISL6537A_6506EVAL1Z is a versatile platform that allows designers to gain a full understanding of the functionality of the ISL6506 and ISL6537A chipset in an ACPI compliant system. The board is also flexible enough to allow the designer to modify the board for differing requirements. The following pages provide a schematic, bill of materials, and layout drawings to support implementation of this solution.

References

For Intersil documents available on the web, see <http://www.intersil.com/>

- [1] *ISL6537A Data Sheet*, Intersil Corporation, FN9143.
- [2] *ISL6506 Data Sheet*, Intersil Corporation, FN9141.
- [3] *Designing Stable Compensation Networks for Single Phase Voltage Mode Buck Regulators*, Intersil Corporation, TB417.
- [4] *Advanced Configuration and Power Interface Specification, Revision 3.0a*, Hewlett Packard, Intel, Microsoft, Phoenix Technologies and Toshiba Corporations.
- [5] *ATX Specification, Version 2.2*, Intel Corporation

ISL6537A_6506EVAL1Z Schematic

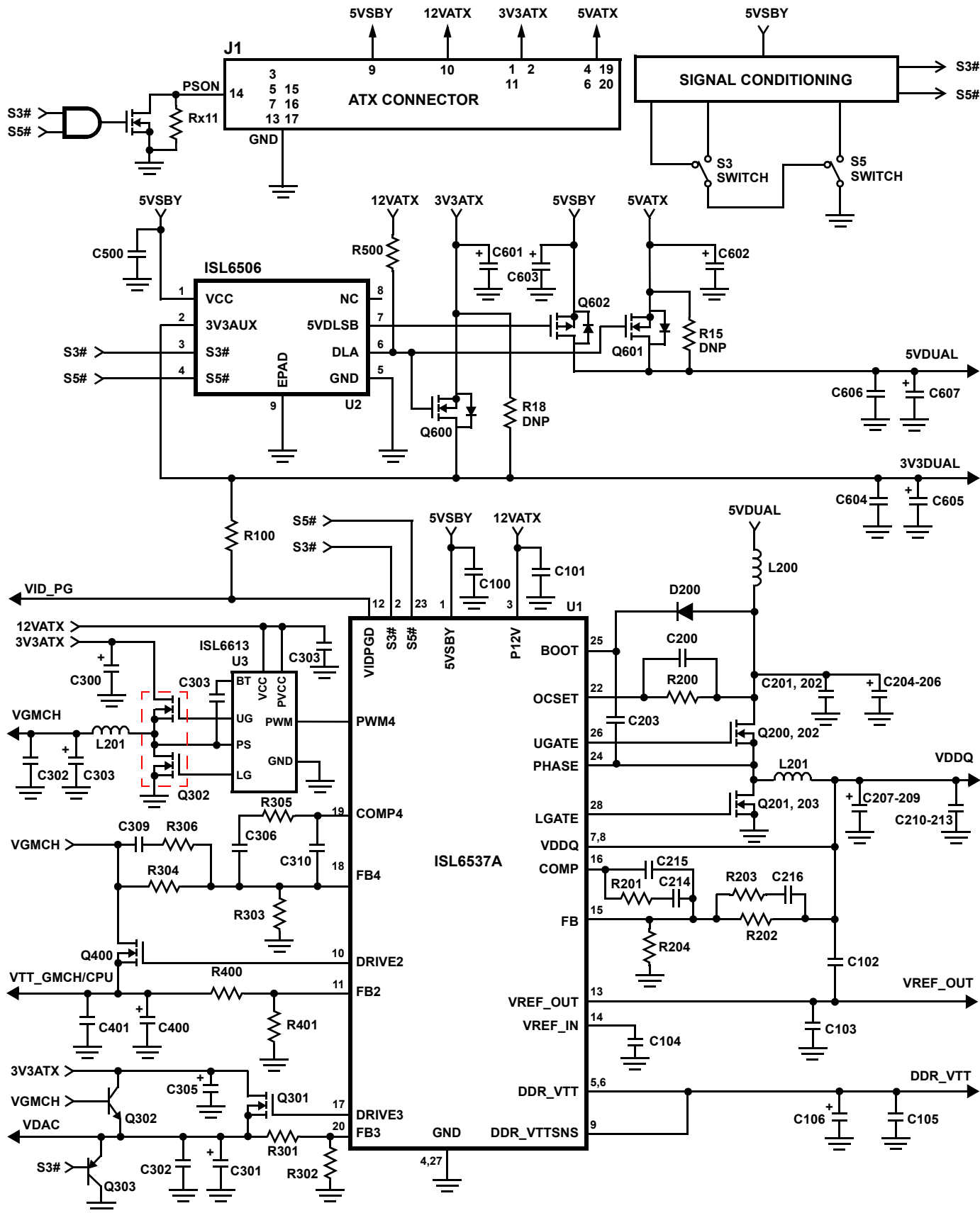

ISL6537A_6506EVAL1Z Bill of Material

REF DES	DESCRIPTION	PKG	VENDOR	VENDOR P/N	QTY
C100, 101, 201, 202, 307, 308	1μF, X5R Capacitor	0603	Various		6
C204-206	2200μF, 6.3V MBZ Capacitor	10x20	Rubycon	6.3MBZ2200M10X20	3
C207, 208, 209, 301, 304, 400, 605, 607	1800μF, 16V MBZ Capacitor	10x23	Rubycon	16MBZ1800M10X23	8
C106, 300, 305, 601, 602, 603	220μF, 25V	8x11.5	Panasonic	EEU-FCIE221	6
C105, 210-213, 302, 304, 401, 500, 604, 606	22μF Capacitor	1206	Various		11
C102, 103, 203, 317	0.1μF Capacitor	0603	Various		4
C104	0.47μF, 10V, X5R MLC Capacitor	0603	TDK	C1608X5R1A474K	1
C200	1000pF, X7R Capacitor	0603	Various		1
C214	4700pF, X7R Capacitor	0603	Various		1
C215	1500pF, X7R Capacitor	0603	Various		1
C216	56nF, X7R Capacitor	0603	Various		1
C306	10nF, X7R Capacitor	0603	Various		1
C309	33nF, X7R Capacitor	0603	Various		1
C310	3300pF, X7R Capacitor	0603	Various		1
D200	Diode		Various	MA732	1
L200, 201, 302	2.1μH, 2mΩ Inductor 7T 14AWG on T50-52B Core		Various		3
Q200-203, 301, 400, 600	30V N-Channel MOSFET	PowerPak	Vishay	Si7840BDP	7
Q300	30V Dual N-Channel MOSFET	PowerPak	Vishay	Si7844BDP	1
Q601	30V N-Channel MOSFET	PowerPak	Vishay	Si7880BDP	1
Q602	30V P-Channel MOSFET	PowerPak	Vishay	Si7483BDP	1
R100	10.0kΩ, 1% Resistor	0603	Various		1
R200	5.76kΩ, 1% Resistor	0603	Various		1
R201	31.6kΩ, 1% Resistor	0603	Various		1
R202, 301, 304	1.74kΩ, 1% Resistor	0603	Various		1
R203	21.0Ω, 1% Resistor	0603	Various		1
R204	1.37kΩ, 1% Resistor	0603	Various		1
R302	1.40kΩ, 1% Resistor	0603	Various		1
R303	1.96kΩ, 1% Resistor	0603	Various		1
R305	18.2kΩ, 1% Resistor	0603	Various		1
R306	36.5Ω, 1% Resistor	0603	Various		1
R309, 310	0Ω Jumper	0603	Various		1
R400	1.24kΩ, 1% Resistor	0603	Various		1
R401	2.43kΩ, 1% Resistor	0603	Various		1
R500	1.00kΩ, 1% Resistor	0603	Various		1
U1	ACPI Compliant DDR, GMCH Regulator	28Ld 6x6mm QFN	Intersil	ISL6537ACR	1
U2	ACPI Controller	8Ld ESOIC	Intersil	ISL6506ECB	1
U3	MOSFET Gate Driver	8Ld SOIC	Intersil	HIP6603BCB	1

ISL6537A_6506EVAL1Z Layout

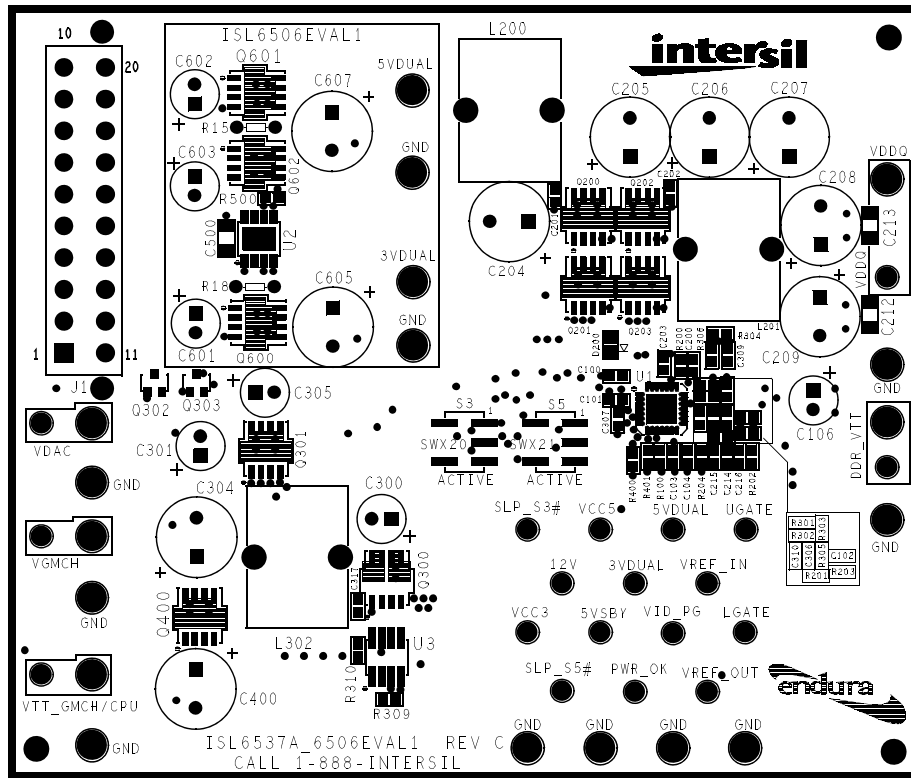

FIGURE 21. TOP SILK SCREEN

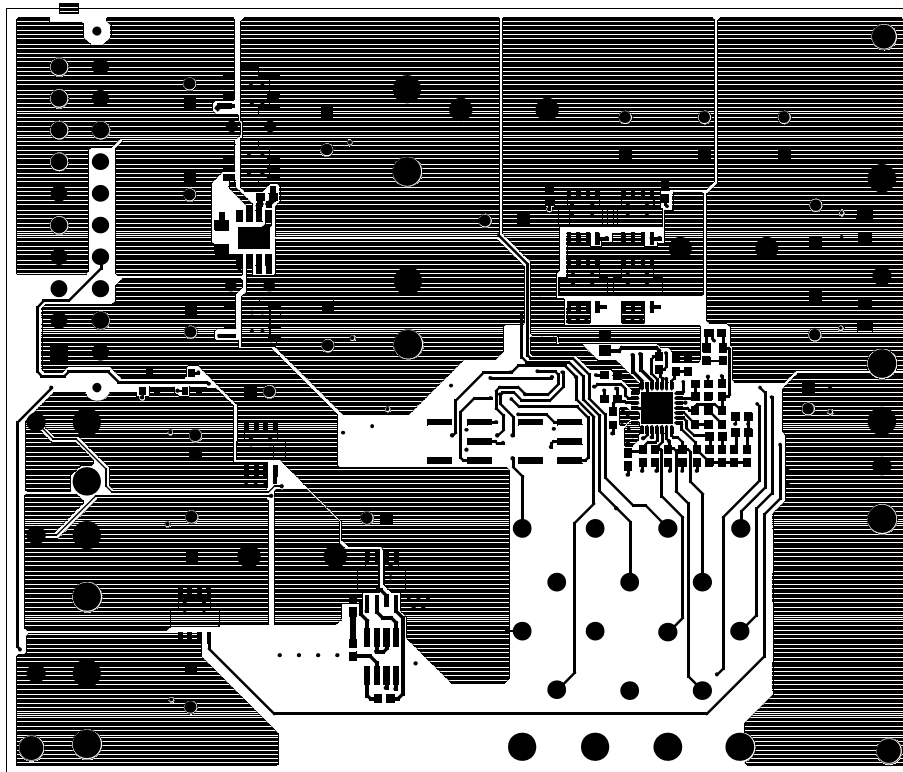

FIGURE 22. TOP

ISL6537A_6506EVAL1Z Layout (Continued)

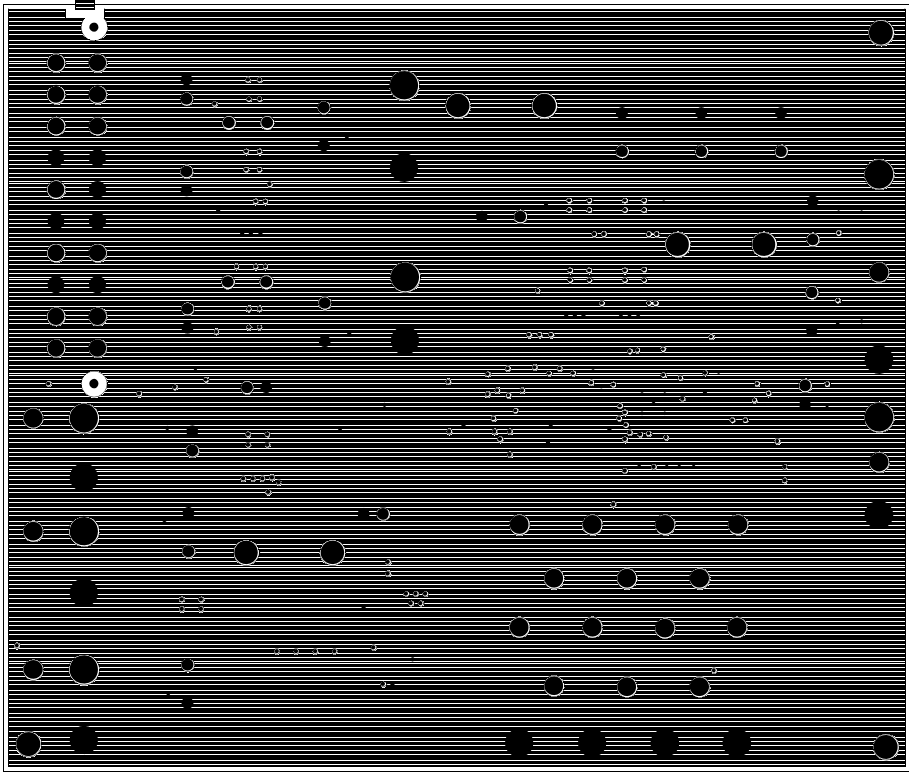

FIGURE 23. INTERNAL 1 GROUND

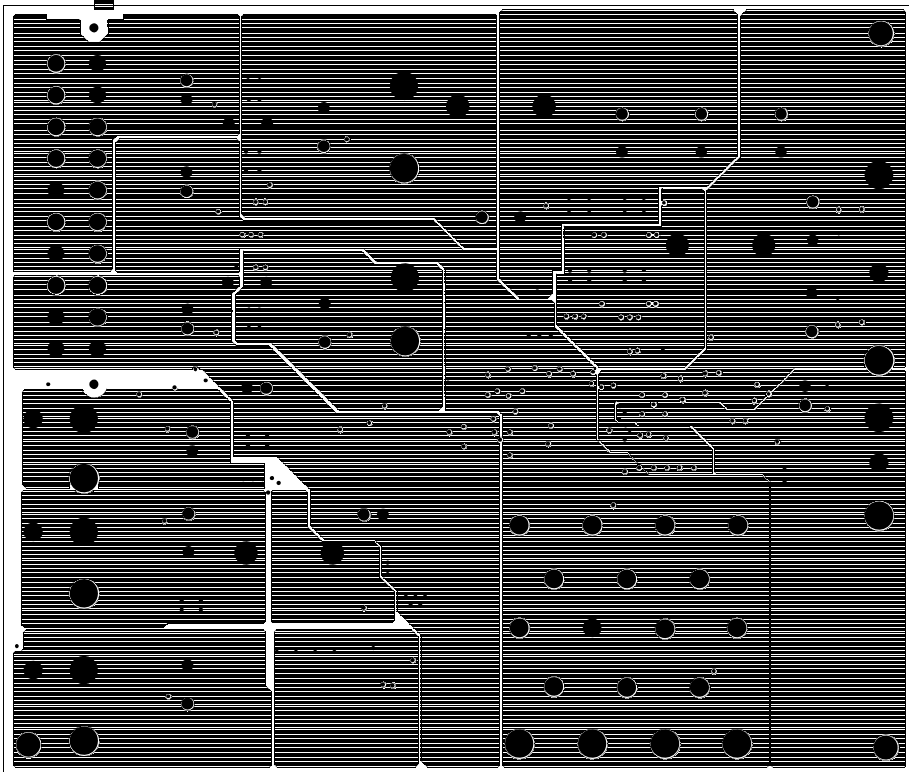

FIGURE 24. INTERNAL 2 POWER

ISL6537A_6506EVAL1Z Layout (Continued)

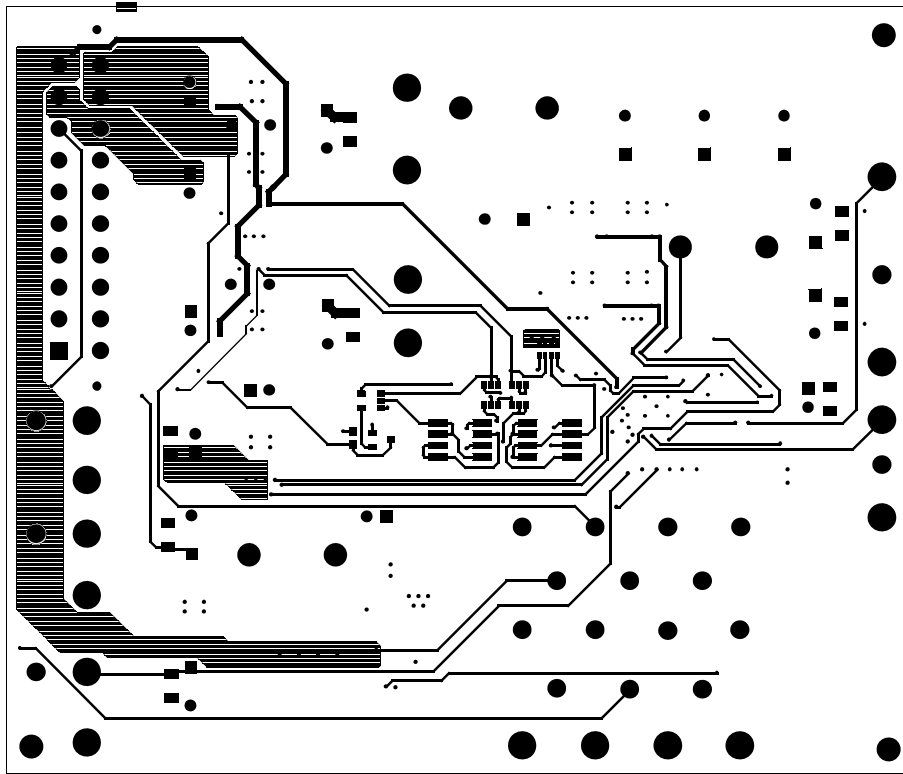

FIGURE 25. BOTTOM

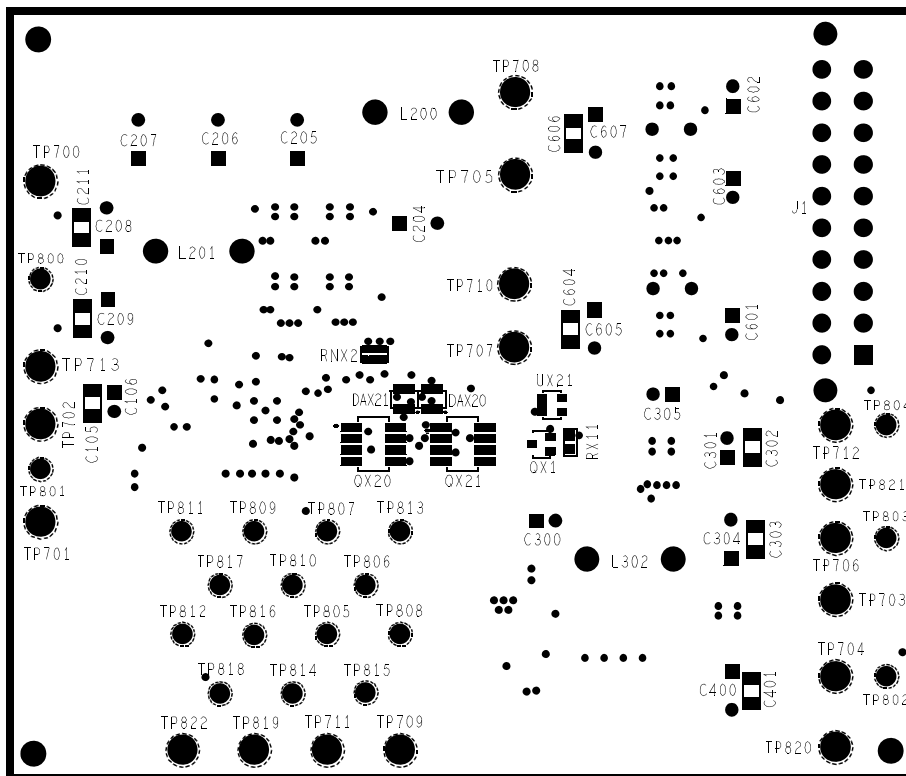

FIGURE 26. BOTTOM SILK SCREEN (REVERSED)

Notice

1. Descriptions of circuits, software and other related information in this document are provided only to illustrate the operation of semiconductor products and application examples. You are fully responsible for the incorporation or any other use of the circuits, software, and information in the design of your product or system. Renesas Electronics disclaims any and all liability for any losses and damages incurred by you or third parties arising from the use of these circuits, software, or information.
2. Renesas Electronics hereby expressly disclaims any warranties against and liability for infringement or any other claims involving patents, copyrights, or other intellectual property rights of third parties, by or arising from the use of Renesas Electronics products or technical information described in this document, including but not limited to, the product data, drawings, charts, programs, algorithms, and application examples.
3. No license, express, implied or otherwise, is granted hereby under any patents, copyrights or other intellectual property rights of Renesas Electronics or others.
4. You shall not alter, modify, copy, or reverse engineer any Renesas Electronics product, whether in whole or in part. Renesas Electronics disclaims any and all liability for any losses or damages incurred by you or third parties arising from such alteration, modification, copying or reverse engineering.
5. Renesas Electronics products are classified according to the following two quality grades: "Standard" and "High Quality". The intended applications for each Renesas Electronics product depends on the product's quality grade, as indicated below.
"Standard": Computers; office equipment; communications equipment; test and measurement equipment; audio and visual equipment; home electronic appliances; machine tools; personal electronic equipment; industrial robots; etc.
"High Quality": Transportation equipment (automobiles, trains, ships, etc.); traffic control (traffic lights); large-scale communication equipment; key financial terminal systems; safety control equipment; etc.
Unless expressly designated as a high reliability product or a product for harsh environments in a Renesas Electronics data sheet or other Renesas Electronics document, Renesas Electronics products are not intended or authorized for use in products or systems that may pose a direct threat to human life or bodily injury (artificial life support devices or systems; surgical implantations; etc.), or may cause serious property damage (space system; undersea repeaters; nuclear power control systems; aircraft control systems; key plant systems; military equipment; etc.). Renesas Electronics disclaims any and all liability for any damages or losses incurred by you or any third parties arising from the use of any Renesas Electronics product that is inconsistent with any Renesas Electronics data sheet, user's manual or other Renesas Electronics document.
6. When using Renesas Electronics products, refer to the latest product information (data sheets, user's manuals, application notes, "General Notes for Handling and Using Semiconductor Devices" in the reliability handbook, etc.), and ensure that usage conditions are within the ranges specified by Renesas Electronics with respect to maximum ratings, operating power supply voltage range, heat dissipation characteristics, installation, etc. Renesas Electronics disclaims any and all liability for any malfunctions, failure or accident arising out of the use of Renesas Electronics products outside of such specified ranges.
7. Although Renesas Electronics endeavors to improve the quality and reliability of Renesas Electronics products, semiconductor products have specific characteristics, such as the occurrence of failure at a certain rate and malfunctions under certain use conditions. Unless designated as a high reliability product or a product for harsh environments in a Renesas Electronics data sheet or other Renesas Electronics document, Renesas Electronics products are not subject to radiation resistance design. You are responsible for implementing safety measures to guard against the possibility of bodily injury, injury or damage caused by fire, and/or danger to the public in the event of a failure or malfunction of Renesas Electronics products, such as safety design for hardware and software, including but not limited to redundancy, fire control and malfunction prevention, appropriate treatment for aging degradation or any other appropriate measures. Because the evaluation of microcomputer software alone is very difficult and impractical, you are responsible for evaluating the safety of the final products or systems manufactured by you.
8. Please contact a Renesas Electronics sales office for details as to environmental matters such as the environmental compatibility of each Renesas Electronics product. You are responsible for carefully and sufficiently investigating applicable laws and regulations that regulate the inclusion or use of controlled substances, including without limitation, the EU RoHS Directive, and using Renesas Electronics products in compliance with all these applicable laws and regulations. Renesas Electronics disclaims any and all liability for damages or losses occurring as a result of your noncompliance with applicable laws and regulations.
9. Renesas Electronics products and technologies shall not be used for or incorporated into any products or systems whose manufacture, use, or sale is prohibited under any applicable domestic or foreign laws or regulations. You shall comply with any applicable export control laws and regulations promulgated and administered by the governments of any countries asserting jurisdiction over the parties or transactions.
10. It is the responsibility of the buyer or distributor of Renesas Electronics products, or any other party who distributes, disposes of, or otherwise sells or transfers the product to a third party, to notify such third party in advance of the contents and conditions set forth in this document.
11. This document shall not be reprinted, reproduced or duplicated in any form, in whole or in part, without prior written consent of Renesas Electronics.
12. Please contact a Renesas Electronics sales office if you have any questions regarding the information contained in this document or Renesas Electronics products.
(Note 1) "Renesas Electronics" as used in this document means Renesas Electronics Corporation and also includes its directly or indirectly controlled subsidiaries.
(Note 2) "Renesas Electronics product(s)" means any product developed or manufactured by or for Renesas Electronics.

(Rev.4.0-1 November 2017)



SALES OFFICES

Renesas Electronics Corporation

<http://www.renesas.com>

Refer to "<http://www.renesas.com/>" for the latest and detailed information.

Renesas Electronics America Inc.
1001 Murphy Ranch Road, Milpitas, CA 95035, U.S.A.
Tel: +1-408-432-8888, Fax: +1-408-434-5351

Renesas Electronics Canada Limited
9251 Yonge Street, Suite 8309 Richmond Hill, Ontario Canada L4C 9T3
Tel: +1-905-237-2004

Renesas Electronics Europe Limited
Dukes Meadow, Millboard Road, Bourne End, Buckinghamshire, SL8 5FH, U.K
Tel: +44-1628-651-700, Fax: +44-1628-651-804

Renesas Electronics Europe GmbH
Arcadiastrasse 10, 40472 Düsseldorf, Germany
Tel: +49-211-6503-0, Fax: +49-211-6503-1327

Renesas Electronics (China) Co., Ltd.
Room 1709 Quantum Plaza, No.27 ZhichunLu, Haidian District, Beijing, 100191 P. R. China
Tel: +86-10-8235-1155, Fax: +86-10-8235-7679

Renesas Electronics (Shanghai) Co., Ltd.
Unit 301, Tower A, Central Towers, 555 Langao Road, Putuo District, Shanghai, 200333 P. R. China
Tel: +86-21-2226-0888, Fax: +86-21-2226-0999

Renesas Electronics Hong Kong Limited
Unit 1601-1611, 16/F., Tower 2, Grand Century Place, 193 Prince Edward Road West, Mongkok, Kowloon, Hong Kong
Tel: +852-2265-6688, Fax: +852-2886-9022

Renesas Electronics Taiwan Co., Ltd.
13F, No. 363, Fu Shing North Road, Taipei 10543, Taiwan
Tel: +886-2-8175-9600, Fax: +886-2-8175-9670

Renesas Electronics Singapore Pte. Ltd.
80 Bendemeer Road, Unit #06-02 Hyflux Innovation Centre, Singapore 339949
Tel: +65-6213-0200, Fax: +65-6213-0300

Renesas Electronics Malaysia Sdn.Bhd.
Unit 1207, Block B, Menara Amcorp, Amcorp Trade Centre, No. 18, Jln Persiaran Barat, 46050 Petaling Jaya, Selangor Darul Ehsan, Malaysia
Tel: +60-3-7955-9390, Fax: +60-3-7955-9510

Renesas Electronics India Pvt. Ltd.
No.777C, 100 Feet Road, HAL 2nd Stage, Indiranagar, Bangalore 560 038, India
Tel: +91-80-67208700, Fax: +91-80-67208777

Renesas Electronics Korea Co., Ltd.
17F, KAMCO Yangjae Tower, 262, Gangnam-daero, Gangnam-gu, Seoul, 06265 Korea
Tel: +82-2-558-3737, Fax: +82-2-558-5338