

RGS..U, RGS..UDIN



1-Phase, 17.5mm solid state relays 'U' type connection



Description

Aim of this solid state switching device is to switch heater loads and motor loads frequently. The range offers solutions up to 30 AAC in 17.5 mm width.

Output connections are provided via a box clamp. Input connections are via a screw connection having a captivated washer allowing for safe looping. Options with integrated heatsink are available in the RGC range.

The RGS...DIN provides an option for DIN mounting of the RGS series with a rating of 10 AAC @ 40°C.

Specifications are at a surrounding temperature of 25°C unless otherwise specified.

Benefits

- **Panel space savings.** The slimmest product in the range accommodates up to 30 AAC in a width of only 17.5 mm giving 25% space saving per SSR compared to 22.5 mm solutions.
- **Less maintenance costs.** Wire bonding technology reduces thermal and mechanical stresses of the output chips resulting in a larger number of operational cycles compared to other assembly technologies.
- **Low machine downtime.** Integrated overvoltage protection prevents the solid state relay from breaking down due to uncontrolled transients that may occur on the lines.
- **Cost effective protection co-ordination.** The high I²t specification permits easy Type 2 protection co-ordination with B-type Miniature Circuit Breakers.
- **Fast wiring.** Power connections are equipped with terminals that can handle cables up to 25 mm² / AWG3 cables.
- **Accommodates UL508A requirements for Industrial Control Panels.** The RGS is certified as a listed product. All models carry a 100 kArms Short Circuit Current Rating.

Applications

Plastic injection machines, Extrusion machines, Blow moulding machines, Thermoformers, Dryers, Electrical ovens, Fryers, Shrink tunnels, Air handling units, Sterilisation equipment, Climatic chambers, Ovens and furnaces.

Main features

- Zero cross or Instant on switching AC solid state relay
- Ratings up to 660 VAC, 30AAC
- Up to 1800 A²s for I²t
- Control voltages: 4-32 VDC, 20-275 VAC (24-190 VDC)
- Integrated overvoltage protection with varistor

Order code

RGS1 **60** **30KGU**

 Enter the code option instead of . Refer to selection guide section for valid part numbers.

Code	Option	Description	Comments
R	-	Solid State Relay (RG)	
G	-		
S	-	With integrated heatsink	
1	-	1-pole switching	
<input type="checkbox"/>	A	Switching mode: Zero Cross (ZC)	
	B	Switching mode: Instant ON (IO)	
60		Rated voltage: 42-660 VAC, 1200 Vp	
<input type="checkbox"/>	D	Control voltage: 4-32 VDC	
	A	Control voltage: 20-275 VAC, 24-190 VDC	
20	-	Rated current: 20 AAC	Available with DIN rail mount accessory only
30	-	Rated current: 30 AAC	
K	-	Screw connection for control terminals	
G	-	Box clamp connection for power terminals	
U	-	Contact configuration	
<input type="checkbox"/>	-		Single packaging
	HT¹	Thermal pad	Option
	DIN¹	Din rail mount	Option
	X40	Bulk packaging of 40 pcs.	Option

1. Add suffix 'HT' to RGS part number for RGS with attached thermal pad. Add suffix 'DIN' to RGS part number for DIN rail mountable RGS.

Selection guide - RGS..

Rated voltage	Switching mode	Control voltage	Rated operational current
			30 AAC (1800 A ² s)
600 VAC	Zero Cross (ZC)	4 - 32 VDC	RGS1A60D30KGU
		20-275 VAC, 24-190 VDC	RGS1A60A30KGU
	Instant ON (IO)	4 - 32 VDC	RGS1B60D30KGU

Selection guide - RGS..DIN (RGS for DIN Rail Mounting)

Rated voltage	Switching mode	Control voltage	Rated operational current
			10 AAC (1800 A ² s)
600 VAC	Zero Cross (ZC)	4 - 32 VDC	RGS1A60D20KGUDIN

KGU: input terminals = screw, output terminals = box clamp

Carlo Gavazzi compatible components

Description	Component code	Notes
Screw kits	SRWKITM5X30MM	- RGS Screw kit for mounting to heatsink - Torx T20, size M5 x 30 mm - Packing qty: 20 pcs
Thermal pad	RGHT	Pack of 10 thermal pads size of 34.6 x 14mm
RG DIN clip	RGS1DIN	Din clip accessory
Heatsinks	RGS..H..	RGS mounted on heatsink

Carlo Gavazzi further reading

Information	Where to find it	Notes
Datasheet	https://gavazziautomation.com/images/PIM/DATASHEET/ENG/rgc_u.pdf	Solid state contactor, RGC with 'U' - type configuration
Datasheet	https://gavazziautomation.com/images/PIM/DATASHEET/ENG/rgs.pdf	Solid state relay, RGS series without integrated heatsink with 'E' - type configuration
Datasheet	https://gavazziautomation.com/images/PIM/DATASHEET/ENG/SSR_Accessories.pdf	Heatsink range overview
Datasheet	https://gavazziautomation.com/nsc/hq/en/solid_state_relays	Heatsink selector tool

Structure

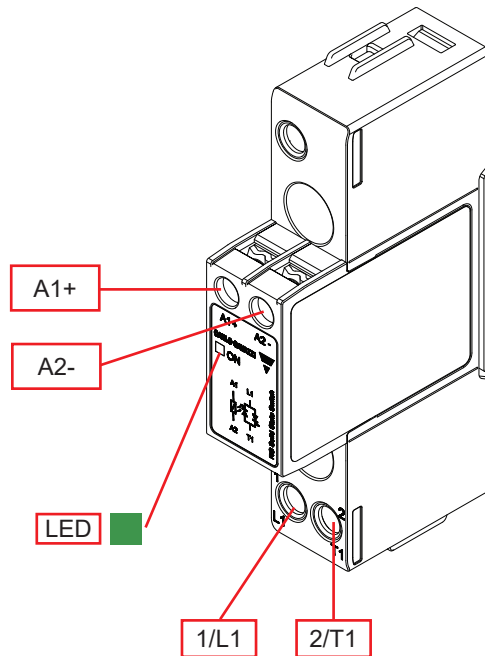

Element	Component	Function
1/L1	Power connections	Mains connections
2/T1	Power connections	Load connections
A1, A2	Control connection	Terminals for control voltage
Green LED	CONTROL indicator	Indicates presence of control voltage and supply voltage

Features

General data

Material	PA66 or PA6 (UL94 V0), RAL7035 850°C, 750°C/2s according to GWIT and GWFI requirements of EN 60335-1	
Mounting	Panel mount	
Touch Protection	IP20	
Overvoltage Category	III, 6 kV (1.2/50 μ s) rated impulse withstand voltage	
Isolation	Input and Output to Case Input to Output	4000 Vrms 4000 Vrms
Weight	RGS.. RGS...DIN	approx. 103g approx. 155g

Performance

Output Specifications

	RGS..U	RGS..UDIN ⁴
Operational voltage range, Ue	42-600 VAC +10%, -15% on max.	
Blocking voltage	1200 Vp	
Max. operational current per pole²: AC-51 @ Ta=40°C	30 AAC	10AAC
Max. operational current per pole²: AC-53a @ Ta=40°C	8 AAC	-
Operational frequency range	45 to 65 Hz	
Output protection	Integrated varistor	
Leakage current @ rated voltage	3mAAC	
Minimum operational current	250 mACA	150 mACA
Repetitive overload current (Motor rating) UL508: Ta=40°C, t_{ON}=1 s, t_{OFF}=9 s, 50 cycles	84 AAC	-
Non-repetitive surge current (I_{TSM}), t=10 ms	600 Ap	325 Ap
I²t for fusing (t=10 ms), minimum	1800 A ² s	525 A ² s
No. of motor starts per hour^{2,3} (x: 6, Tx:6s, F:50%) @ 40°C	30	-
Power factor	>0.5 at rated voltage	-
Critical dV/dt (@Tj init = 40°C)	1000 V/ μ s	

2. Refer to Heatsink selection table

3. Overload profile for AC-53a: Ie: AC-53a: x-Tx: F-S,

where Ie = nominal current (AC-53a AAC), x = overload current factor, Tx = duration of overload current (s), F = duty cycle (%), S = number of starts per hour. Example; 8A: AC-53a: 6 - 6 : 50 - 30 = max. 30 starts for the RGS..30 with an overload profile of 48A for 6 seconds with a duty cycle of 50%

Motor Ratings²: HP (UL508) / kW (EN/IEC 60947-4-2) @ 40°C

	115 VAC	230 VAC	400 VAC	480 VAC	600 VAC
RGS..30	3/4HP / 0.37kW	2HP / 1.1kW	3HP / 1.5kW	5HP / 2.2kW	5HP / 3.7kW

4: Refer to Derating vs. Spacing Curves

Inputs

	RGS..D..	RGS..A..
Control voltage range (A1, A2) ⁵	4 - 32 VDC	20-275 VAC, 24 (-10%) -190 VDC
Pick-up voltage	3.8 VDC	-
Drop-out voltage	1.0 VDC	5 VAC/DC
Maximum reverse voltage	32 VDC	-
Maximum response time, RGS1A	0.5 cycle + 500 μ s @ 24 VDC	2 cycles @ 230 VAC/110 VDC
Maximum response time, RGS1B	350 μ s @ 24 VDC	N/A
Response time drop-out	0.5 cycle + 500 μ s @ 24VDC	0.5 cycle + 40 ms @ 230 VAC/ 110 VDC
Input current @ 40°C	See diagrams below	

5: DC control to be supplied by a Class 2 power source according to UL1310

Input current vs input voltage

RGS..D..

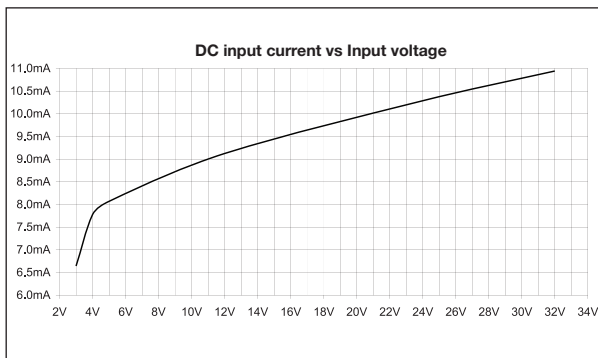

RGS..A..

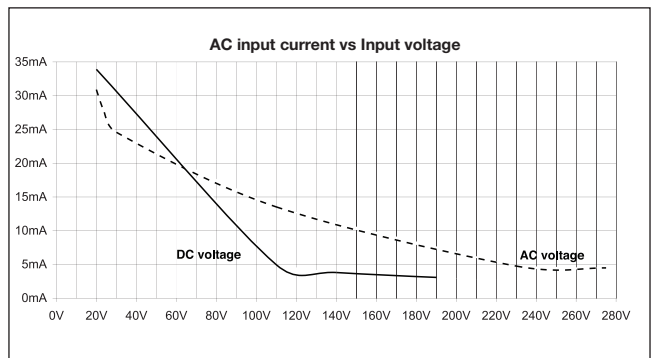

Output power dissipation

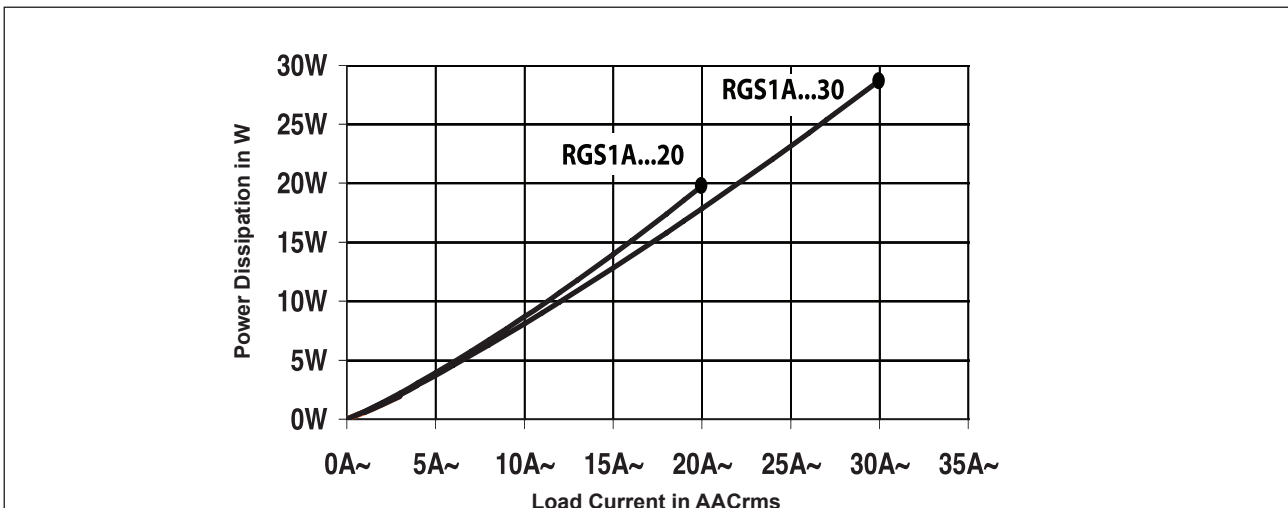

Derating vs. Spacing Curves for RGS...DIN

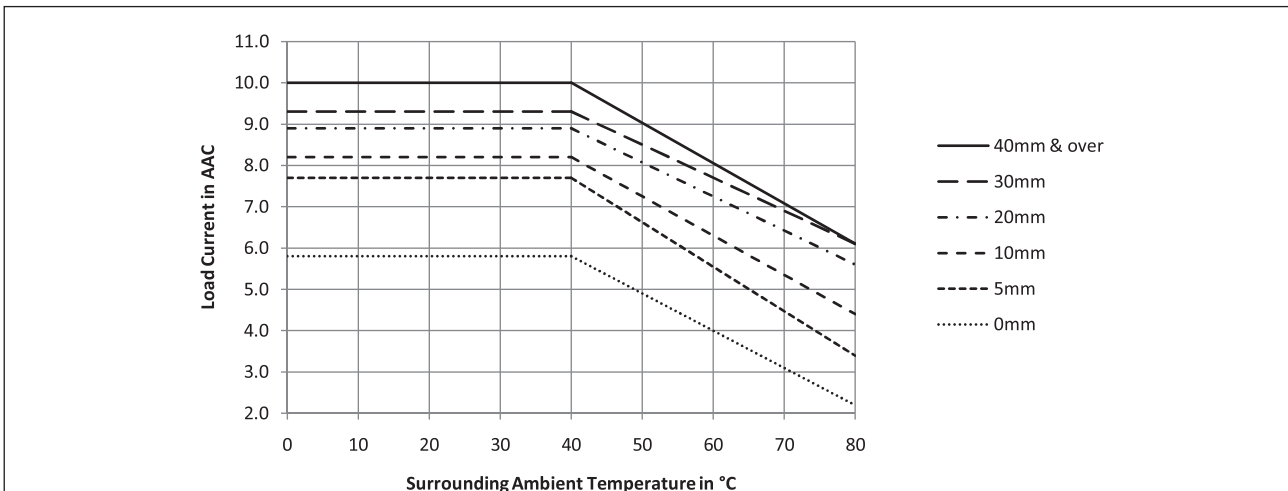

Heatsink selection

Thermal resistance [°C/W] of RGS1..30

Load current [A]	Surrounding ambient temperature [°C]						
	20	30	40	50	60	70	80
32.0	2.6	2.3	2.0	1.6	1.3	0.98	0.66
29.0	3.0	2.6	2.2	1.9	1.5	1.1	0.74
25.5	3.4	3.0	2.6	2.1	1.7	1.3	0.86
22.5	4.0	3.5	3.0	2.5	2.0	1.5	1.0
19.0	4.8	4.2	3.6	3.0	2.4	1.8	1.2
16.0	5.9	5.2	4.5	3.7	3.0	2.2	1.5
13.0	7.7	6.7	5.8	4.8	3.8	2.9	1.9
9.5	10.7	9.3	8.0	6.7	5.3	4.0	2.7
6.5	16.9	14.8	12.7	10.6	8.5	6.3	4.2
3.2	-	-	-	-	18.4	13.8	9.2

Thermal resistance [°C/W] of RGS1..30..HT

Load current [A]	Surrounding ambient temperature [°C]						
	20	30	40	50	60	70	80
32.0	2.3	2.0	1.6	1.3	0.98	0.65	0.33
29.0	2.8	2.4	2.0	1.6	1.3	0.9	0.52
25.5	3.4	2.9	2.5	2.1	1.6	1.2	0.78
22.5	4.0	3.5	3.0	2.5	2.0	1.5	1.0
19.0	4.8	4.2	3.6	3.0	2.4	1.8	1.2
16.0	5.9	5.2	4.5	3.7	3.0	2.2	1.5
13.0	7.7	6.7	5.8	4.8	3.8	2.9	1.9
9.5	10.7	9.3	8.0	6.7	5.3	4.0	2.7
6.5	16.9	14.8	12.7	10.6	8.5	6.3	4.2
3.2	-	-	-	-	18.4	13.8	9.2





Thermal data

	RGS..30..
Max. junction temperature	125°C
Junction to case thermal resistance, R_{thjc}	<0.3°C/W
Case to heatsink thermal resistance, R_{thcs}^6	<0.25°C/W
Case to heatsink thermal resistance (RGS..HT), $R_{thcs_HT}^7$	<0.85°C/W

6: Thermal resistance case to heatsink values are applicable upon application of a fine layer of silicon based thermal paste HTS02S from Electrolube between SSR and heatsink.

7: Thermal resistance case to heatsink values for RGS..HT are applicable for the RGHT thermal pad that is pre-attached from the factory to the RGS.

Compatibility and conformance

Approvals	    
Standards compliance	LVD: EN/IEC 60947-4-2, EN/IEC 60947-4-3 EMCD: EN 60947-4-3 UL508 Recognised (E172877) CSA 22.2 No.14-13 (204075) VDE 0660-109
UL short circuit current rating	100k Arms (refer to short circuit current section, Type 1 – UL508)

Electromagnetic compatibility (EMC) - Immunity	
Electrostatic discharge (ESD)	EN/IEC 61000-4-2 8 kV air discharge, 4 kV contact (PC1)
Radiated radio frequency	EN/IEC 61000-4-3 10 V/m, from 80 MHz to 1 GHz (PC1) 10 V/m, from 1.4 to 2 GHz (PC1) 10 V/m, from 2 to 2.7 GHz (PC1)
Electrical fast transient (burst)	EN/IEC 61000-4-4 Output: 2 kV, 5 kHz (PC1) Input: 1 kV, 5 kHz (PC1)
Conducted radio frequency	EN/IEC 61000-4-6 10 V/m, from 0.15 to 80 MHz (PC1)
Electrical surge	EN/IEC 61000-4-5 Output, line to line: 1 kV (PC1) Output, line to earth: 2 kV (PC1) Input, line to line: 1 kV (PC2) Input, line to earth: 2 kV (PC2)
Voltage dips	EN/IEC 61000-4-11 0% for 0.5, 1 cycle (PC2) 40% for 10 cycles (PC2) 70% for 25 cycles (PC2) 80% for 250 cycles (PC2)
Voltage interruptions	EN/IEC 61000-4-11 0% for 5000 ms (PC2)

Electromagnetic compatibility (EMC) - Emissions	
Radio interference field emission (radiated)	EN/IEC 55011 Class A: from 30 to 1000 MHz
Radio interference voltage emissions (conducted)	EN/IEC 55011 Class A: from 0.15 to 30 MHz (External filter may be required - refer to Filtering section)

Additional conformance to railway standards

Applicable to variants	RGS..U
Additional conformance specific to railway applications	EN 50155 EN 45545-2 EN 50121-3-2
Hazardous level conformance according to EN 45545-2	HL1, HL2 for requirement R23 HL1 for requirement R22
Operating temperature class according to EN 50155	OT3 (-25 °C to +70 °C)
Vibration and shock	EN 61373 Category 1, Class B
Additional EMC conformance	according to EN 50121-3-2
Radiated radio frequency immunity	EN/IEC 61000-4-3 20 V/m, from 80 MHz to 1 GHz (PC1) 10 V/m, from 1.4 to 2 GHz (PC1) 5 V/m, from 2 to 2.7 GHz (PC1) 3V/m, 5.1 - 6 GHz (PC1)
Power quality measurement	EN/IEC 61000-4-30 50 Hz - 2 kHz, <8% THD (PASS)

Note:

- Control input lines must be installed together to maintain products' susceptibility to Radio Frequency interference.
- Use of AC solid state relays may, according to the application and the load current, cause conducted radio interferences. Use of mains filters may be necessary for cases where the user must meet E.M.C requirements. The capacitor values given inside the filtering specification tables should be taken only as indications, the filter attenuation will depend on the final application.
- Performance Criteria 1 (PC1): No degradation of performance or loss of function is allowed when the product is operated as intended.
- Performance Criteria 2 (PC2): During the test, degradation of performance or partial loss of function is allowed. However when the test is complete the product should return operating as intended by itself.
- Performance Criteria 3 (PC3): Temporary loss of function is allowed, provided the function can be restored by manual operation of the controls.

Filter connection diagram

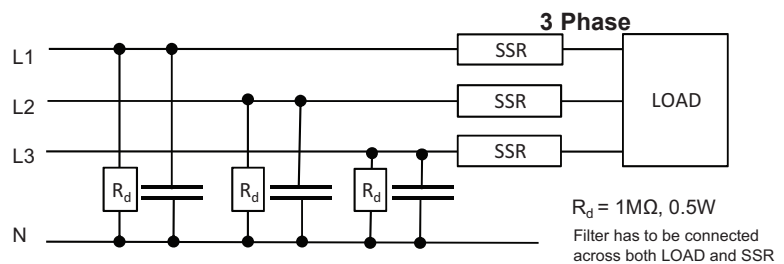
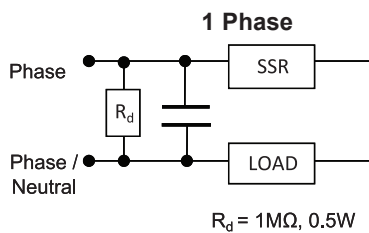

Filtering

Part number	Suggested filter for EN 55011 Class A compliance	Maximum heater current [AAC]
RGS1...20	100 nF / 760 V / X1	10 AAC
RGS1...30	330 nF / 760 V / X1	30 AAC

Environmental specifications

Operating temperature	-40°C to +80°C (-40°F to +176°F)
Storage temperature	-40 to +100 °C (-40 to +212 °F)
Relative humidity	95% non-condensing @ 40°C
Pollution degree	2
Installation altitude	0-1000 m. Above 1000 m derate linearly by 1% of FLC per 100 m up to a maximum of 2000 m
Vibration resistance	2g / axis (2-100Hz, IEC 60068-2-6, EN 50155, EN 61373)
Impact resistance	15/11 g/ms (EN50155, EN61373)
EU RoHS compliant	Yes
China RoHS	

The declaration in this section is prepared in compliance with People's Republic of China Electronic Industry Standard SJ/T11364-2014: Marking for the Restricted Use of Hazardous Substances in Electronic and Electrical Products.

Part Name	Toxic or Harardous Substances and Elements					
	Lead (Pb)	Mercury (Hg)	Cadmium (Cd)	Hexavalent Chromium (Cr(VI))	Polybrominated biphenyls (PBB)	Polybrominated diphenyl ethers (PBDE)
Power Unit Assembly	x	O	O	O	O	O

O: Indicates that said hazardous substance contained in homogeneous materials for this part are below the limit requirement of GB/T 26572.

X: Indicates that said hazardous substance contained in one of the homogeneous materials used for this part is above the limit requirement of GB/T 26572.

这份申明根据中华人民共和国电子工业标准
SJ/T11364-2014：标注在电子电气产品中限定使用的有害物质

零件名称	有毒或有害物质与元素					
	铅 (Pb)	汞 (Hg)	镉 (Cd)	六价铬 (Cr(VI))	多溴化联苯 (PBB)	多溴联苯醚 (PBDE)
功率单元	x	O	O	O	O	O

O:此零件所有材料中含有的该有害物低于GB/T 26572的限定。

X: 此零件某种材料中含有的该有害物高于GB/T 26572的限定。



Short circuit protection

Protection Co-ordination, Type 1 vs Type 2:

Type 1 protection implies that after a short circuit, the device under test will no longer be in a functioning state. In Type 2 co-ordination the device under test will still be functional after the short circuit. In both cases, however the short circuit has to be interrupted. The fuse between enclosure and supply shall not open. The door or cover of the enclosure shall not be blown open. There shall be no damage to conductors or terminals and the conductors shall not separate from terminals. there shall be no breakage or cracking of insulating bases to the extent that the integrity of the mounting of live parts is impaired. Discharge of parts or any risk of fire shall not occur.

The product variants listed in the table hereunder are suitable for use on a circuit capable of delivering not more than 100,000 Arms Symmetrical Amperes, 600 Volts maximum when protected by fuses. Tests at 100,000 A were performed with Class J fuses, fast acting; please refer to the table below for maximum allowed ampere rating of the fuse. Use fuses only.

Tests with Class J fuses are representative of Class CC fuses.

Protection co-ordination Type 1 according to UL 508				
Part No.	Prospective short circuit current [kArms]	Max fuse size [A]	Class	Voltage [VAC]
RGS...20	100	10	J	Max. 600
		15	CC	
RGS...30		30	J or CC	

Protection co-ordination (IEC/EN 60947-4-2/ -4-3)						
Part No.	Prospective short circuit current [kArms]	Ferraz Shawmut (Mersen)		Siba		Voltage [VAC]
		Max fuse size [A]	Part number	Max fuse size [A]	Part number	
RGS...20	100	32	6.9xx CP URD 22x58 /32	32	50 142 06 32	Max. 600
RGS...30		40	A70QS40-4	32	50 142 06 32	

Protection co-ordination Type 2 with Miniature Circuit Breakers (M.C.B.s)				
Solid State Relay type	ABB Model no. for Z - type M. C. B. (rated current)	ABB Model no. for B - type M. C. B. (rated current)	Wire cross sectional area [mm ²]	Minimum length of Cu wire conductor [m] ⁸
RGS..20 (1800 A ² s)	1-pole S201 - Z4 (4A) S201 - Z6 UC (6A)	S201 - B2 (2A) S201 - B2 (2A)	1.0	21.0
			1.0	21.0
			1.5	31.5
RGS..30 (1800 A ² s)	1-pole S201 - Z10 (10A)	S201 - B4 (4 A)	1.0	7.6
			1.5	11.4
			2.5	19.0
	S201 - Z16 (16A)	S201 - B6 (6 A)	1.0	5.2
			1.5	7.8
			2.5	13.0
	S201 - Z20 (20A)	S201 - B10 (10 A)	4.0	20.8
			1.5	12.6
	S201 - Z25 (25A)	S201 - B13 (13 A)	2.5	21.0
			4.0	25.0
2-pole S202 - Z25 (25A)	S202 - B13 (13 A)	2.5	40.0	
		4.0	19.0	
			30.4	

8. Between MCB and Load (including return path which goes back to the mains)

Note: A prospective current of 6 kA and a 230 / 400 V power supply is assumed for the above suggested specifications. For cables with different cross section than those mentioned above please consult Carlo Gavazzi's Technical Support Group.

S201 models refer to 1-pole M.C.B., S202 models refer to 2-poles M.C.B.

Dimensions

RGS...KGU

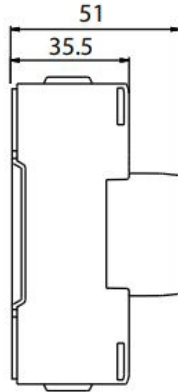
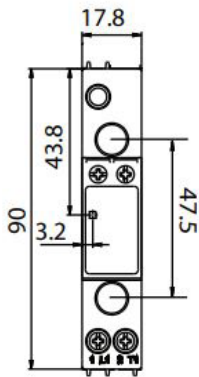

RGS...KGUDIN

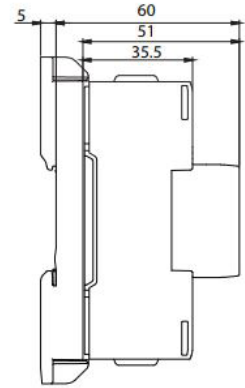
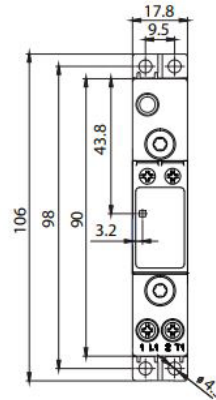

Housing width tolerance +0.5mm, -0mm as per DIN 43880. All other tolerances +/- 0.5mm.
Dimensions in mm.

Terminal Layout

RGS...KGU

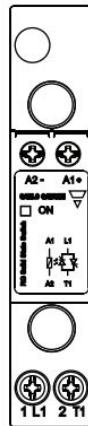

1/L1: Supply connection
2/T1: Load connection
A1 (+): Positive control signal
A2 (-): Control ground

Connection Diagram

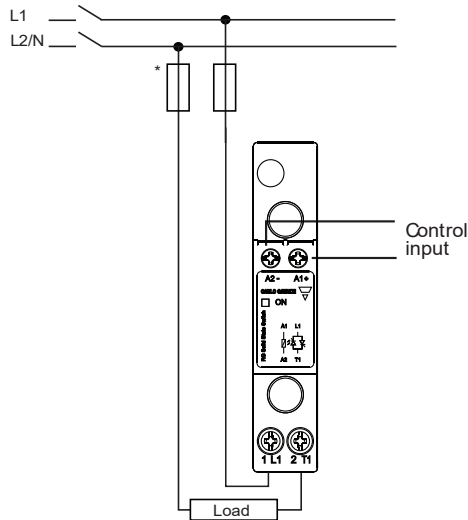

* depends on system requirements

Functional diagram

DC control

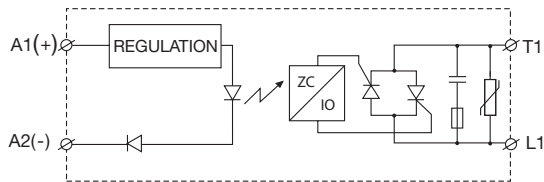

AC control

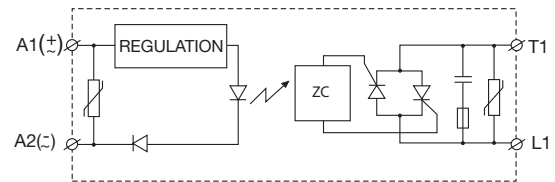

Installation Instructions

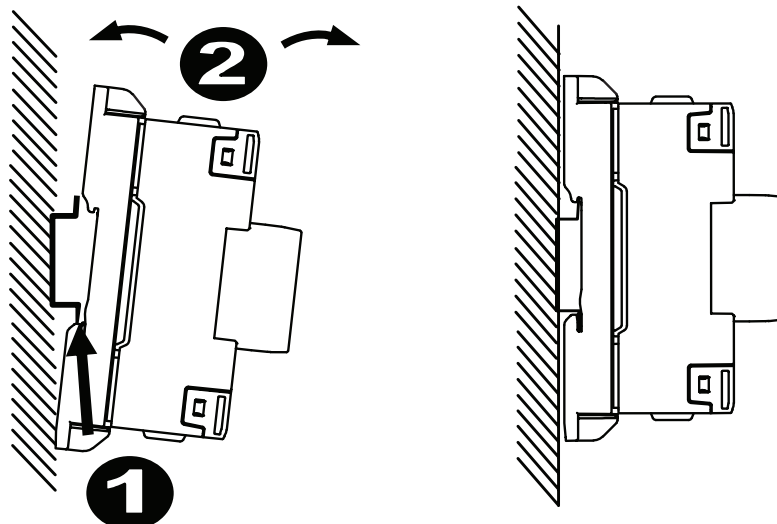

Mounting instructions for RGS..KGU

Thermal stress will reduce the lifetime of the SSR. Therefore it is necessary to select the appropriate heatsinks, taking into account the surrounding temperature, load current and the duty cycle.

A fine layer of thermally conductive silicone paste must be evenly applied to the back of the SSR. RGS should be mounted on the heatsink with two M5 x 30mm screws (**SRWKITM5X30MM**).

Gradually tighten each screw (alternating between the two) until both are tightened with a torque of 0.75 Nm. Then tighten both screws to their final mounting torque of 1.5 Nm.

In case of a thermal pad attached to the back of the SSR, no thermal paste is required. The RGS is gradually tightened (alternating between the 2 screws) to a maximum torque of 1.5Nm.

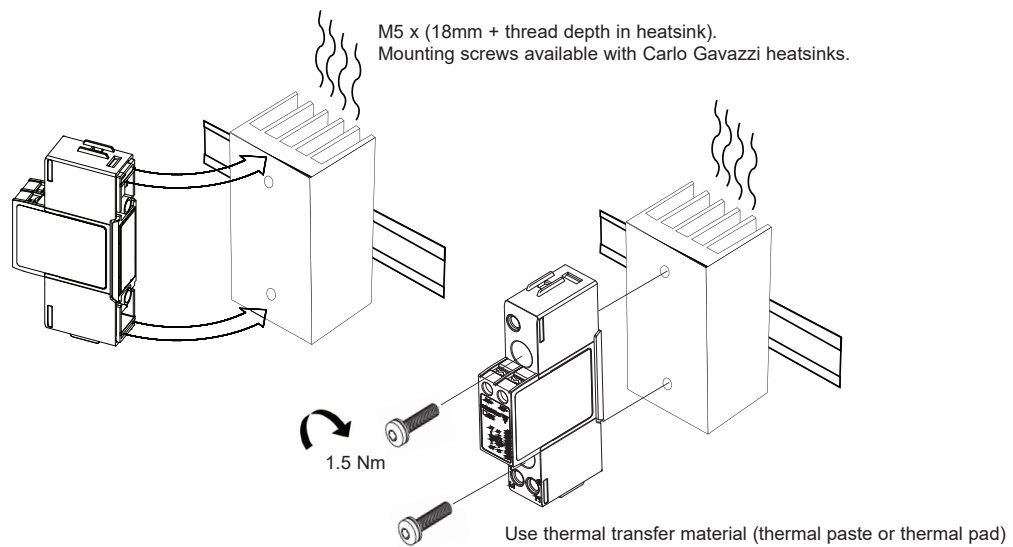

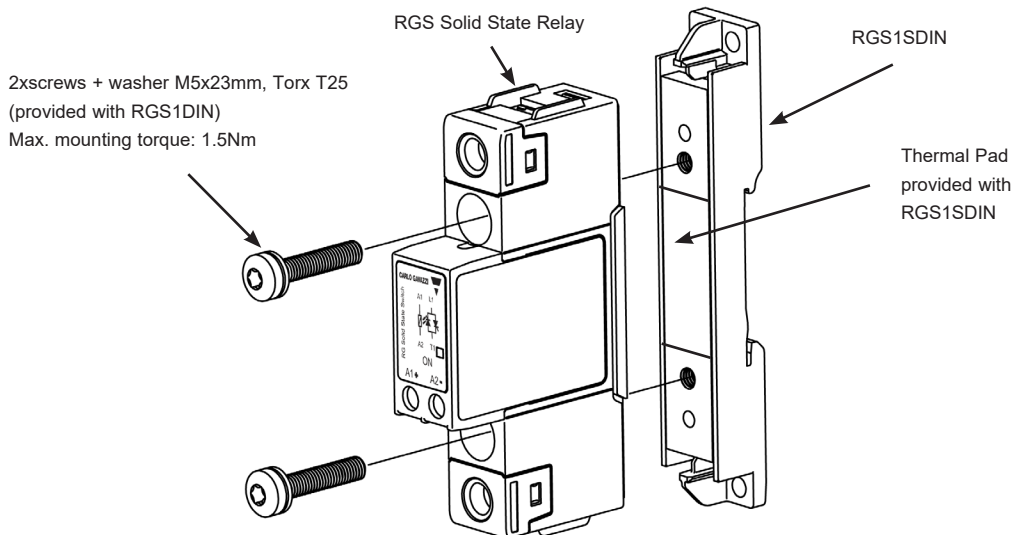

Mounting Instructions for RGS1DIN to RGS



Connection Specifications

Power connection	
Terminal	1/L1, 2/T1
Conductors	Use 75°C copper (Cu) conductors
	
Stripping length	12 mm
Connection type	M3.5 with box clamp
Rigid (solid & stranded) UL/CSA rated data	1x 1..6 mm ² 1x 18..10 AWG
Flexible with end sleeve	1x 0.5..2.5 mm ² 1x 20..14 AWG
Flexible without end sleeve	1x 1..4 mm ² 1x 18..12 AWG
Torque specifications	Posidrive bit 1 UL: 1 Nm (8.85 lb-in) IEC: 0.9 - 1.1 Nm (8.0 - 9.7 lb-in)

Control connection	
Terminals	A1(+), A2(-)
Conductors	Use 60/75°C copper (Cu) conductors
	 
Stripping length	8 mm
Connection type	M3 screw with captivated washer
Rigid (solid & stranded) UL/CSA rated data	2x 0.5 - 2.5 mm ² 2x 18 - 12 AWG
Flexible with end sleeve	2x 0.5 - 2.5 mm ² 2x 18 - 12 AWG
Torque specification	Posidrive 1 UL: 0.5 Nm (4.4 lb-in) IEC: 0.5-0.6 Nm (4.4-5.3 lb-in)

Packaging



- Packing qty.: 40 pcs.
- Weight: 4.2 Kgs



COPYRIGHT ©2021

Content subject to change. Download the PDF: <https://gavazziautomation.com>