

Chip Bead ABGK Series

**Automotive
AEC-Q200**

RoHS Compliant
Halogen Free
REACH Compliant



Noise
Suppression

Shield

Multilayer

Ferrite

Medium
Current

Part Numbering

A	BGK	00	160808	121	Y	00
Grade	Series Name	Control Code	Dimensions Code (mm)	Impedance (Ω)	Tolerance	Internal Code
			160808 1.6x0.8x0.8	600 60	Y ±25%	
			201209 2.0x1.25x0.9	121 120		
				102 1000		

This specification applies to Multilayer Chip ferrite Bead for Automotive Electronics based on AEC-Q200 except for Power train and Safety.

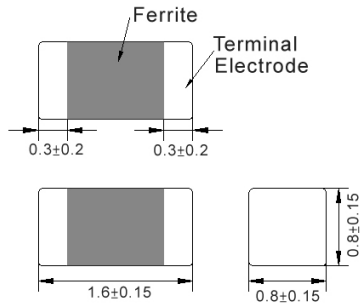
ABGK00160808 Type
■ Dimensions

unit:mm

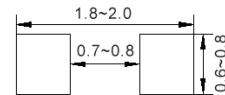
■ Recommended Land Pattern

unit:mm

■ Electrical Characteristics

Part No.	Impedance (Ω)	Test Freq.	RDC (Ω)Max.	Rated Current (mA)Max.
ABGK00160808100Y00	10	100 MHz,200 mV	0.03	1000
ABGK00160808300Y00	30	100 MHz,200 mV	0.06	800
ABGK00160808600Y00	60	100 MHz,200 mV	0.06	700
ABGK00160808800Y00	80	100 MHz,200 mV	0.10	600
ABGK00160808121Y00	120	100 MHz,200 mV	0.15	600
ABGK00160808201Y00	200	100 MHz,200 mV	0.18	400
ABGK00160808221Y00	220	100 MHz,200 mV	0.18	550
ABGK00160808301Y00	300	100 MHz,200 mV	0.25	500
ABGK00160808471Y00	470	100 MHz,200 mV	0.30	400
ABGK00160808601Y00	600	100 MHz,200 mV	0.30	400
ABGK00160808102Y00	1000	100 MHz,200 mV	0.45	300

Note: When ordering, please specify tolerance code. Tolerance: Y=±25%

1. Operating temperature range - 55°C ~ 125°C
2. Rate Current : Applied the current to coils, the temperature rise shall not be more than 30°C
3. Measure Equipment:
 Z: HP4291A
 RDC: HP4338B or CHEN HWA 502

ABGK00160808 Type

Characteristics Graph

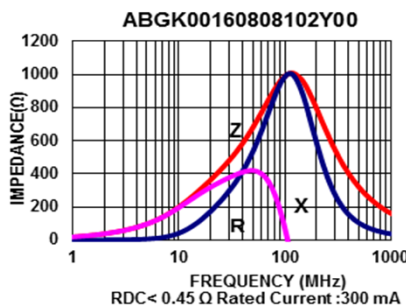
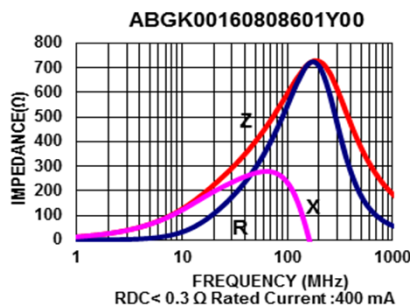
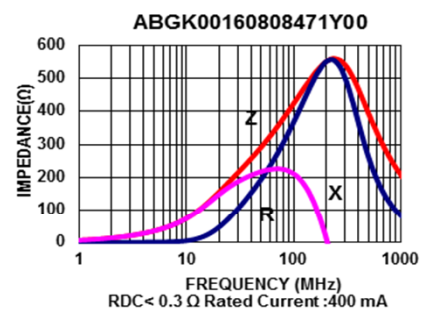
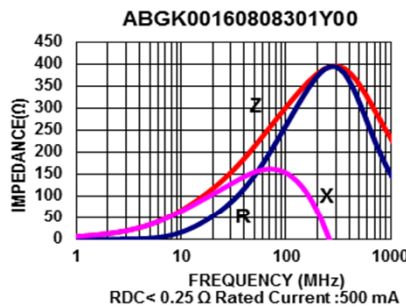
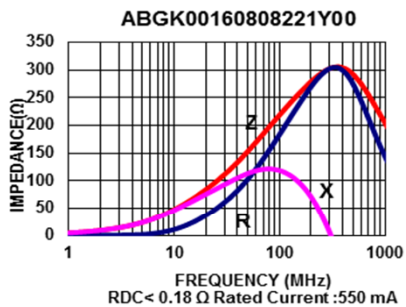
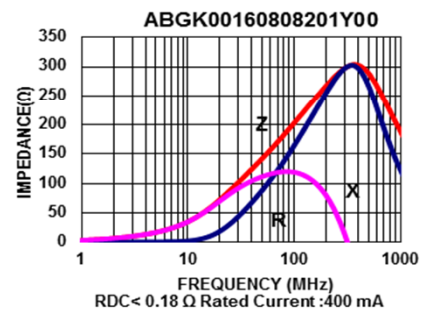
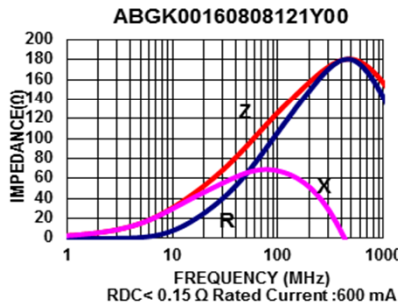
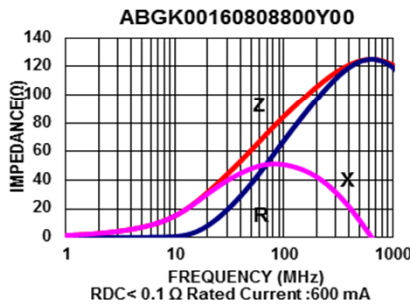
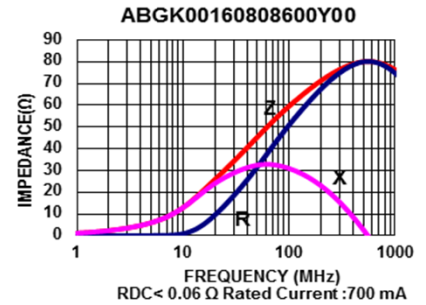
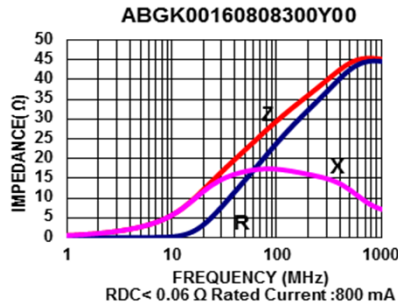
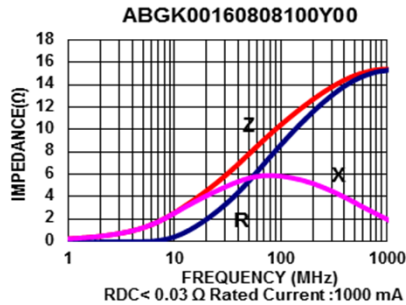

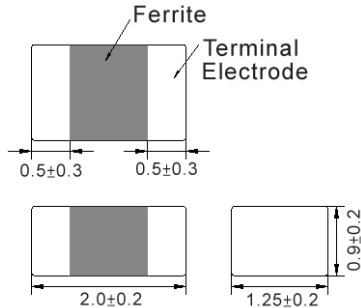
ABGK00201209 Type
■ Dimensions

unit:mm

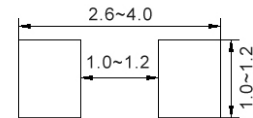
■ Recommended Land Pattern

unit:mm

■ Electrical Characteristics

Part No.	Impedance (Ω)	Test Freq.	RDC (Ω)Max.	Rated Current (mA)Max.
ABGK00201209600Y00	60	100 MHz,200 mV	0.10	900
ABGK00201209800Y00	80	100 MHz,200 mV	0.10	800
ABGK00201209121Y00	120	100 MHz,200 mV	0.15	800
ABGK00201209221Y00	220	100 MHz,200 mV	0.18	750
ABGK00201209301Y00	300	100 MHz,200 mV	0.18	700
ABGK00201209601Y00	600	100 MHz,200 mV	0.25	500
ABGK00201209102Y00	1000	100 MHz,200 mV	0.30	400

Note: When ordering, please specify tolerance code. Tolerance: Y=±25%

- Operating temperature range - 55°C ~ 125°C
- Rate Current : Applied the current to coils, the temperature rise shall not be more than 30°C
- Measure Equipment:
 Z: HP4291A
 RDC: HP4338B or CHEN HWA 502

ABGK00201209 Type

Characteristics Graph

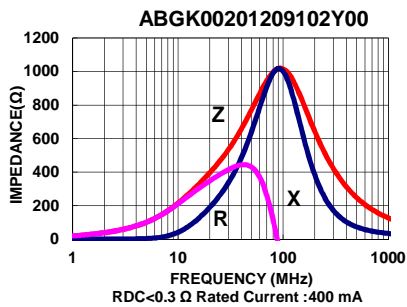
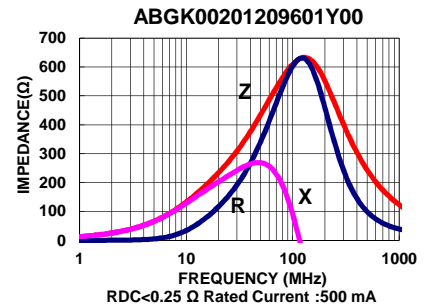
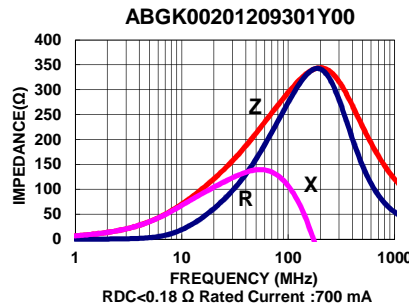
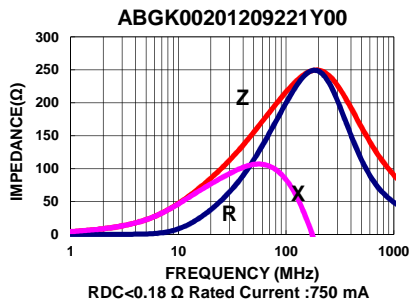
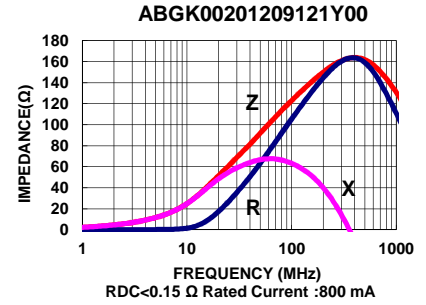
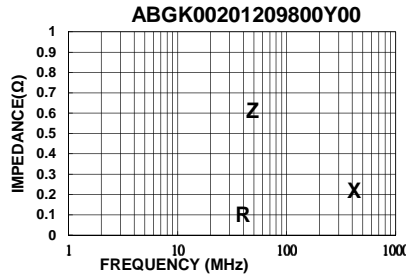
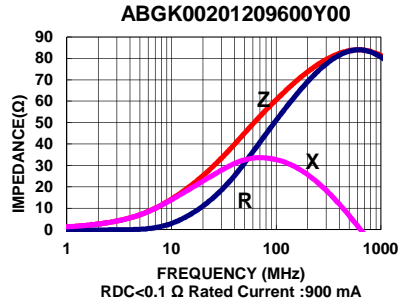

■ Packaging

Tape Dimensions

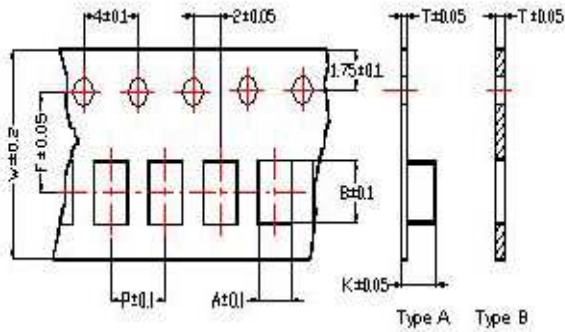

Tape Material

Carrier Tape: Polycarbonate (Tape A)
Carrier Tape: Paper (Tape B)
Cover Tape: Polystyrene

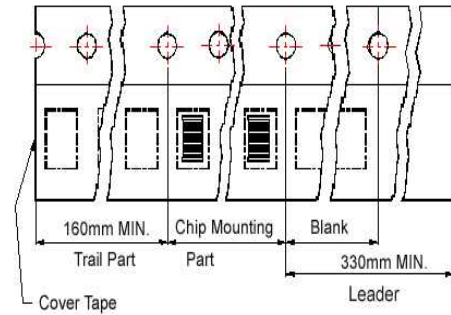

Reel Dimensions

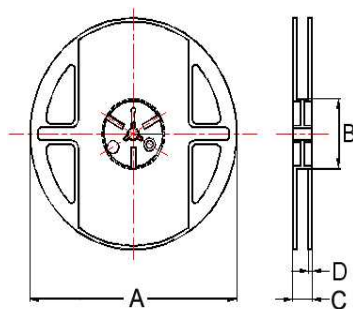

Dimensions in mm

TYPE	Tape Dimensions								Reel Dimensions				Quantity
	A	B	T	W	P	F	K	Tape	A	B	C	D	PCS / Reel
ABGK00160808	1.05	1.85	0.95	8	4	3.5	-	B	178	60	12	2	4000
ABGK00201209	1.5	2.30	0.97	8	4	3.5	-	B	178	60	12	2	4000