

RECOMMENDED PCB LAYOUT: COMPONENT SIDE

NOTES:

- MATERIAL:
HSG: NYLON, GLASS-FILLED, UL94V-0, COLOR: BLACK
CAP: NYLON, GLASS-FILLED, UL94V-0, COLOR: BLACK
PIN: 0.64MM SQ, COPPER ALLOY
- PLATING TYPE:
(1) GOLD FLASH OVER
1.25µm MIN. NICKEL OVERALL.
(2) GOLD FLASH ON CONTACT AND
2.50µm MIN. TIN ON SOLDER TAIL OVER
1.25µm MIN. NICKEL OVERALL.
(4) 0.38µm MIN. GOLD PLATE ON CONTACT AND
2.00µm MIN. TIN ON SOLDER TAIL OVER
1.25µm MIN. NICKEL OVERALL.
(5) 0.75µm MIN. GOLD PLATE ON CONTACT AND
2.00µm MIN. TIN ON SOLDER TAIL OVER
1.25µm MIN. NICKEL OVERALL.
(6) 2.50µm MIN. TIN OVERALL
1.25µm MIN. NICKEL OVERALL
- PRODUCT SPECIFICATION: PS-87920-019
- PACKAGING TYPE: SEE TABLE
- PACKAGING SPEC:
TUBE WITH CAP VERSION: PK-89990-558
TUBE W/O CAP VERSION: PK-89990-545
TRAY W/O CAP: PK-89990-489
EMBOSS TAPE WITH CAP: PK-89990-486 AND PK-87898-400
- WAFER TO BE FLAT WITHIN 0.003 mm/mm
- BEND DEPRESSION IS ACCEPTED SO LONG AS IT DOES NOT AFFECT THE OVERALL COPLANARITY OF TAIL
- COPLANARITY IS TO BE MEASURED BY RESTING THE SOLDER TAIL ON A FLAT SURFACE
- IRREGULAR CIRCUIT CUTOFF WITHIN BREAKAWAY SECTION IS PERMISSIBLE. CUTTING OR CHIPPING OF THE MAIN BODY IS NOT ACCEPTABLE
- CAP LOCATION IS CENTERED ALONG THE MATING ENDS AS SHOWN. TOP SURFACE OF CAP TO BE FLAT FOR THE PURPOSE OF PICK & PLACE BY VACUUM SUCTION NOZZLE
- RECOMMENDED PCB THICKNESS IS 1.60mm±0.10
- THE ABOVE CKT 6 IS FOR ILLUSTRATION PURPOSE ONLY
- TUBE LENGTH AS PER STANDARD 560mm

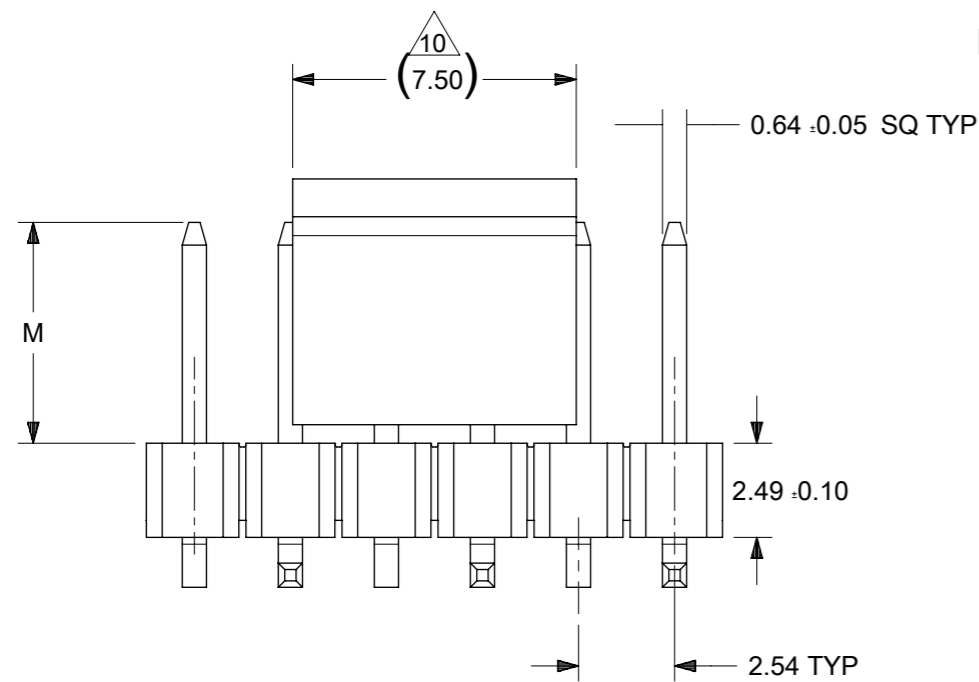

THIS DRAWING CONTAINS INFORMATION THAT IS PROPRIETARY TO MOLEX ELECTRONIC TECHNOLOGIES, LLC AND SHOULD NOT BE USED WITHOUT WRITTEN PERMISSION									
DIMENSION UNITS		SCALE		CURRENT REV DESC: BRIGHT TIN PHASE OUT					
mm		NTS							
GENERAL TOLERANCES (UNLESS SPECIFIED)									
		MM	INCH	CUSTOM HEADER 2.54MM PITCH SINGLE ROW SINGLE WAFER SMT HEADER PRODUCT CUSTOMER DRAWING					
4 PLACES	±								
3 PLACES	±								
2 PLACES	±	0.2							
1 PLACE	±								
0 PLACES	±			EC NO: 679909		2021/06/29		DOCUMENT NUMBER	
ANGULAR TOL		± 3.0°		DRWN: AKUMAR19		2021/10/11		SD-87898-001	
DRAFT WHERE APPLICABLE MUST REMAIN WITHIN DIMENSIONS		THIRD ANGLE PROJECTION		CHK'D: MRAMAKRISHNA		2021/10/11		DOC TYPE	
				APPR: MRAMAKRISHNA		2021/10/11		DOC PART	
				INITIAL REVISION:				REVISION	
				DRWN: GGUNAGI		2016/11/09		PSD	
				APPR: ISHWARG		2016/12/06		000	
				DRAWING		SERIES		B24	
				A3-SIZE		87898		1 OF 21	
				MATERIAL NUMBER		CUSTOMER			
				SEE TABLE		GENERAL MARKET			

PACKAGING OPTION PART NO.						CKT SIZE	VOID POSITION	PLATING TYPE	DIMENSION				
TRAY WITHOUT CAP	TRAY WITH CAP	TUBE WITHOUT CAP	TUBE WITH CAP	TAPE & REEL WITHOUT CAP	TAPE & REEL WITH CAP				A	B	G	F	M
87898-0301	-----	-----	-----	-----	-----	3	----	1	7.62	5.08	10.81	9.65	5.84
87898-0302	-----	-----	-----	-----	-----	3	----	2	7.62	5.08	10.81	9.65	5.84
87898-0304	-----	-----	-----	-----	87898-0314	3	----	4	7.62	5.08	10.81	9.65	5.84
87898-0305	-----	-----	-----	-----	87898-0315	3	----	5	7.62	5.08	10.81	9.65	5.84
87898-0306	-----	-----	-----	-----	87898-0316	3	----	6	7.62	5.08	10.81	9.65	5.84
87898-0307	-----	-----	-----	-----	87898-0320	3	----	6	7.62	5.08	10.81	9.65	5.84
-----	-----	-----	-----	-----	87898-0317	3	-----	6	7.62	5.08	10.81	9.65	5.84
-----	-----	-----	-----	-----	87898-0321	3	-----	6	7.62	5.08	10.81	9.65	5.84
-----	-----	-----	-----	-----	87898-0318	3	----	5	7.62	5.08	10.81	9.65	5.84
-----	-----	-----	-----	-----	87898-0310	3	-----	6	7.62	5.08	14.91	13.91	10.10
-----	-----	-----	-----	-----	87898-0309	3	-----	6	7.62	5.08	14.81	13.81	10.00
-----	-----	87898-0370	-----	-----	-----	3	-----	6	7.62	5.08	----	13.91	10.10

REFER TO LAST SHEET FOR 2CKT SIZE

(B24)

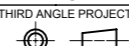
THIS DRAWING CONTAINS INFORMATION THAT IS PROPRIETARY TO MOLEX ELECTRONIC TECHNOLOGIES, LLC AND SHOULD NOT BE USED WITHOUT WRITTEN PERMISSION									
DIMENSION UNITS		SCALE		CURRENT REV DESC: BRIGHT TIN PHASE OUT					
mm		NTS							
GENERAL TOLERANCES (UNLESS SPECIFIED)				EC NO: 679909		DRWN: AKUMAR19		2021/06/29	
				CHK'D: MRAMAKRISHNA		2021/10/11		CUSTOM HEADER	
				APPR: MRAMAKRISHNA		2021/10/11		2.54MM PITCH SINGLE ROW SINGLE WAFER SMT HEADER	
				INITIAL REVISION:				PRODUCT CUSTOMER DRAWING	
				DRWN: GGUNAGI		2016/11/09		DOCUMENT NUMBER	
				APPR: ISHWARG		2016/12/06		SD-87898-001	
ANGULAR TOL ± 3.0°				THIRD ANGLE PROJECTION		DRAWING		DOC TYPE	
DRAFT WHERE APPLICABLE MUST REMAIN WITHIN DIMENSIONS						SERIES		DOC PART	
				A3-SIZE		87898		REVISION	
				MATERIAL NUMBER		CUSTOMER		SHEET NUMBER	
				SEE TABLE		GENERAL MARKET		2 OF 21	

DOCUMENT STATUS	P1	RELEASE DATE	2021/10/11	11:53:29
-----------------	----	--------------	------------	----------

10		9		8		7		6		5		4		3		2		1		
PACKAGING OPTION PART NO.																A	B	G	F	M
TRAY WITHOUT CAP	TRAY WITH CAP	TUBE WITHOUT CAP	TUBE WITH CAP	TAPE & REEL WITHOUT CAP	TAPE & REEL WITH CAP	CKT SIZE	VOID POSITION	PLATING TYPE	MODIFIED MATING CKT	MODIFIED MATING LENGTH	A	B	G	F	M					
-----	-----	87898-0421	87898-0431	-----	87898-0451	4	-----	1	-----	-----	10.16	7.62	10.81	9.65	5.84	B24				
-----	-----	87898-0422	87898-0432	-----	87898-0452	4	-----	2	-----	-----	10.16	7.62	10.81	9.65	5.84					
-----	-----	87898-0424	87898-0434	-----	87898-0454	4	-----	4	-----	-----	10.16	7.62	10.81	9.65	5.84					
-----	-----	87898-0425	87898-0435	-----	87898-0455	4	-----	5	-----	-----	10.16	7.62	10.81	9.65	5.84					
-----	-----	87898-0426	87898-0436	-----	87898-0456	4	-----	6	-----	-----	10.16	7.62	10.81	9.65	5.84					
-----	-----	87898-0428	87898-0437	-----	87898-0460	4	-----	6	-----	-----	10.16	7.62	10.81	9.65	5.84					
-----	-----	-----	-----	-----	87898-0457	4	-----	6	-----	-----	10.16	7.62	10.81	9.65	5.84					
-----	-----	-----	-----	-----	87898-0458	4	-----	5	-----	-----	10.16	7.62	10.81	9.65	5.84					
-----	-----	-----	-----	-----	87898 - 0480	4	CKT# 4	5	-----	-----	10.16	7.62	14.70	13.65	9.84					
-----	-----	-----	-----	-----	87898 - 0481	4	-----	5	CKT # 1, 2 & 3	1.00	10.16	7.62	17.70	16.65	12.84					
87898 - 0482	-----	-----	-----	-----	-----	4	-----	---	CKT # 1, 2 & 3	1.00	10.16	7.62	---	16.65	12.84	E				
-----	-----	-----	-----	-----	87898 - 0483	4	-----	---	CKT # 1, 2 & 3	1.00	10.16	7.62	14.70	13.65	9.84					
-----	-----	87898-0427	-----	-----	-----	4	-----	---	-----	-----	10.16	7.62	---	11.87	8.06					
-----	-----	87898-0521	87898-0531	-----	87898-0551	5	-----	1	-----	-----	12.70	10.16	10.81	9.65	5.84	D				
-----	-----	87898-0522	87898-0532	-----	87898-0552	5	-----	2	-----	-----	12.70	10.16	10.81	9.65	5.84					
-----	-----	87898-0524	87898-0534	-----	87898-0554	5	-----	4	-----	-----	12.70	10.16	10.81	9.65	5.84					
-----	-----	87898-0525	87898-0535	-----	87898-0555	5	-----	5	-----	-----	12.70	10.16	10.81	9.65	5.84					
-----	-----	87898-0526	87898-0536	87898-0583	87898-0556	5	-----	6	-----	-----	12.70	10.16	10.81	9.65	5.84					
-----	-----	87898-0528	87898-0538	87898-0584	87898-0558	5	-----	6	-----	-----	12.70	10.16	10.81	9.65	5.84					
87898-0581	-----	-----	-----	-----	-----	5	-----	4	-----	-----	12.70	10.16	---	24.18	20.25					
-----	-----	-----	-----	-----	87898-0576	5	-----	5	-----	-----	12.70	10.16	14.35	13.31	9.50					
-----	-----	87898-0621	87898-0631	-----	87898-0651	6	-----	1	-----	-----	15.24	12.70	10.81	9.65	5.84					
-----	-----	87898-0622	87898-0632	-----	87898-0652	6	-----	2	-----	-----	15.24	12.70	10.81	9.65	5.84					
-----	-----	87898-0624	87898-0634	-----	87898-0654	6	-----	4	-----	-----	15.24	12.70	10.81	9.65	5.84					
-----	-----	87898-0625	87898-0635	-----	87898-0655	6	-----	5	-----	-----	15.24	12.70	10.81	9.65	5.84					
-----	-----	87898-0626	87898-0636	-----	87898-0656	6	-----	6	-----	-----	15.24	12.70	10.81	9.65	5.84					
-----	-----	87898-0628	87898-0638	-----	87898-0658	6	-----	6	-----	-----	15.24	12.70	10.81	9.65	5.84					
87898-0607	-----	-----	-----	-----	87898-0657	6	-----	6	-----	-----	15.24	12.70	16.47	15.31	11.50					
-----	-----	-----	-----	-----	87898-0605	6	-----	5	-----	-----	15.24	12.70	12.98	11.94	8.13					
-----	-----	87898-0604	-----	-----	-----	6	-----	5	-----	-----	15.24	12.70	---	13.31	9.50					

THIS DRAWING CONTAINS INFORMATION THAT IS PROPRIETARY TO MOLEX ELECTRONIC TECHNOLOGIES, LLC AND SHOULD NOT BE USED WITHOUT WRITTEN PERMISSION

DIMENSION UNITS	SCALE	CURRENT REV DESC: BRIGHT TIN PHASE OUT		molex	
mm	NTS				
GENERAL TOLERANCES (UNLESS SPECIFIED)				CUSTOM HEADER	
				2.54MM PITCH SINGLE ROW SINGLE WAFER SMT HEADER	
				PRODUCT CUSTOMER DRAWING	
4 PLACES	±	±		DOCUMENT NUMBER	
3 PLACES	±	±		SD-87898-001	
2 PLACES	±	0.2	±	DOC TYPE	DOC PART
1 PLACE	±	±		PSD	000
0 PLACES	±	±		REVISION	
ANGULAR TOL ± 3.0°				B24	
DRAFT WHERE APPLICABLE MUST REMAIN WITHIN DIMENSIONS		THIRD ANGLE PROJECTION	DRAWING	SERIES	MATERIAL NUMBER
			A3-SIZE	87898	CUSTOMER
				SEE TABLE	GENERAL MARKET
				SHEET NUMBER	
				3 OF 21	

10		9		8		7		6		5		4		3		2		1	
PACKAGING OPTION PART NO.										DIMENSION									
TRAY WITHOUT CAP	TRAY WITH CAP	TUBE WITHOUT CAP	TUBE WITH CAP	TAPE & REEL WITHOUT CAP	TAPE & REEL WITH CAP	CKT SIZE	VOID POSITION	PLATING TYPE	A	B	G	F	M						
-----	-----	87898-0721	87898-0731	-----	87898-0751	7	----	1	17.78	15.24	10.81	9.65	5.84						
-----	-----	87898-0722	87898-0732	-----	87898-0752	7	----	2	17.78	15.24	10.81	9.65	5.84						
-----	-----	87898-0724	87898-0734	-----	87898-0754	7	----	4	17.78	15.24	10.81	9.65	5.84						
-----	-----	87898-0725	87898-0735	-----	87898-0755	7	----	5	17.78	15.24	10.81	9.65	5.84						
-----	-----	87898-0726	87898-0736	-----	87898-0756	7	----	6	17.78	15.24	10.81	9.65	5.84						
-----	-----	87898-0727	87898-0737	-----	87898-0758	7	----	6	17.78	15.24	10.81	9.65	5.84						
-----	-----	-----	-----	B22 87898-0757	-----	7	----	6	17.78	15.24	---	9.65	5.84						
-----	-----	-----	-----	87898-0759	-----	7	----	6	17.78	15.24	---	9.65	5.84						
-----	-----	87898-0720	-----	-----	-----	7	----	5	17.78	15.24	---	9.81	6.00						
-----	-----	87898-0767	-----	-----	-----	7	----	5	17.78	15.24	---	13.81	10.00						
E																			
-----	-----	87898-0821	87898-0831	-----	87898-0851	8	----	1	20.32	17.78	10.81	9.65	5.84						
-----	-----	87898-0822	87898-0832	-----	87898-0852	8	----	2	20.32	17.78	10.81	9.65	5.84						
-----	-----	87898-0824	87898-0834	-----	87898-0854	8	----	4	20.32	17.78	10.81	9.65	5.84						
-----	-----	87898-0825	87898-0835	-----	87898-0855	8	----	5	20.32	17.78	10.81	9.65	5.84						
-----	-----	87898-0826	87898-0836	-----	87898-0856	8	----	6	20.32	17.78	10.81	9.65	5.84						
-----	-----	87898-0827	87898-0837	-----	87898-0857	8	----	6	20.32	17.78	10.81	9.65	5.84						
87898-0881	-----	-----	-----	-----	-----	8	----	4	20.32	17.78	---	21.84	17.91						
D																			
-----	-----	87898-0921	87898-0931	-----	87898-0951	9	----	1	22.86	20.32	10.81	9.65	5.84						
-----	-----	87898-0922	87898-0932	-----	87898-0952	9	----	2	22.86	20.32	10.81	9.65	5.84						
-----	-----	87898-0924	87898-0934	-----	87898-0954	9	----	4	22.86	20.32	10.81	9.65	5.84						
-----	-----	87898-0925	87898-0935	-----	87898-0955	9	----	5	22.86	20.32	10.81	9.65	5.84						
-----	-----	87898-0926	87898-0936	-----	87898-0956	9	----	6	22.86	20.32	10.81	9.65	5.84						

B24

B24

B24

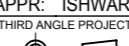
THIS DRAWING CONTAINS INFORMATION THAT IS PROPRIETARY TO MOLEX ELECTRONIC TECHNOLOGIES, LLC AND SHOULD NOT BE USED WITHOUT WRITTEN PERMISSION															
DIMENSION UNITS		SCALE		CURRENT REV DESC: BRIGHT TIN PHASE OUT						 CUSTOM HEADER 2.54MM PITCH SINGLE ROW SINGLE WAFER SMT HEADER					
mm		NTS													
GENERAL TOLERANCES (UNLESS SPECIFIED)															
		MM		INCH						EC NO: 679909 DRWN: AKUMAR19 2021/06/29 CHK'D: MRAMAKRISHNA 2021/10/11 APPR: MRAMAKRISHNA 2021/10/11 INITIAL REVISION: DRWN: GGUNAGI 2016/11/09 APPR: ISHWARG 2016/12/06					
4 PLACES	±		±												
3 PLACES	±		±												
2 PLACES	±	0.2	±												
1 PLACE	±		±												
ANGULAR TOL		± 3.0°								DOCUMENT NUMBER: SD-87898-001 DOC TYPE: PSD DOC PART: 000 REVISION: B24					
DRAFT WHERE APPLICABLE MUST REMAIN WITHIN DIMENSIONS				THIRD ANGLE PROJECTION		DRAWING		SERIES		MATERIAL NUMBER		CUSTOMER		SHEET NUMBER	
						A3-SIZE		87898		SEE TABLE		GENERAL MARKET		4 OF 21	

DOCUMENT STATUS	P1	RELEASE DATE	2021/10/11	11:53:29
-----------------	----	--------------	------------	----------

PACKAGING OPTION PART NO.										DIMENSION				
TRAY WITHOUT CAP	TRAY WITH CAP	TUBE WITHOUT CAP	TUBE WITH CAP	TAPE & REEL WITHOUT CAP	TAPE & REEL WITH CAP	CKT SIZE	VOID POSITION	PLATING TYPE	A	B	G	F	M	
-----	-----	87898-1021	87898-1031	-----	87898-1051	10	-----	1	25.40	22.86	10.81	9.65	5.84	
-----	-----	87898-1022	87898-1032	-----	87898-1052	10	-----	2	25.40	22.86	10.81	9.65	5.84	
-----	-----	87898-1024	87898-1034	-----	87898-1054	10	-----	4	25.40	22.86	10.81	9.65	5.84	
-----	-----	87898-1025	87898-1035	-----	87898-1055	10	-----	5	25.40	22.86	10.81	9.65	5.84	
-----	-----	87898-1026	87898-1036	-----	87898-1056	10	-----	6	25.40	22.86	10.81	9.65	5.84	
-----	-----	87898-1027	87898-1037	-----	87898-1057	10	-----	6	25.40	22.86	10.81	9.65	5.84	
-----	-----	87898-1003	-----	-----	-----	10	-----	5	25.40	22.86	---	9.81	6.00	
-----	-----	87898-1121	87898-1131	-----	87898-1151	11	-----	1	27.94	25.40	10.81	9.65	5.84	
-----	-----	87898-1122	87898-1132	-----	87898-1152	11	-----	2	27.94	25.40	10.81	9.65	5.84	
-----	-----	87898-1124	87898-1134	-----	87898-1154	11	-----	4	27.94	25.40	10.81	9.65	5.84	
-----	-----	87898-1125	87898-1135	-----	87898-1155	11	-----	5	27.94	25.40	10.81	9.65	5.84	
-----	-----	87898-1126	87898-1136	-----	87898-1156	11	-----	6	27.94	25.40	10.81	9.65	5.84	
-----	-----	87898-1221	87898-1231	-----	87898-1251	12	-----	1	30.48	27.94	10.81	9.65	5.84	
-----	-----	87898-1222	87898-1232	-----	87898-1252	12	-----	2	30.48	27.94	10.81	9.65	5.84	
-----	-----	87898-1224	87898-1234	-----	87898-1254	12	-----	4	30.48	27.94	10.81	9.65	5.84	
-----	-----	87898-1225	87898-1235	-----	87898-1255	12	-----	5	30.48	27.94	10.81	9.65	5.84	
-----	-----	87898-1226	87898-1236	-----	87898-1256	12	-----	6	30.48	27.94	10.81	9.65	5.84	

(B24)

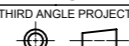
THIS DRAWING CONTAINS INFORMATION THAT IS PROPRIETARY TO MOLEX ELECTRONIC TECHNOLOGIES, LLC AND SHOULD NOT BE USED WITHOUT WRITTEN PERMISSION									
DIMENSION UNITS		SCALE		CURRENT REV DESC: BRIGHT TIN PHASE OUT					
mm		NTS							
GENERAL TOLERANCES (UNLESS SPECIFIED)				EC NO: 679909		CUSTOMER		SD-87898-001	
				DRWN: AKUMAR19		2021/06/29		PSD	
				CHK'D: MRAMAKRISHNA		2021/10/11		000	
				APPR: MRAMAKRISHNA		2021/10/11		B24	
				INITIAL REVISION:		DOCUMENT NUMBER		REVISION	
				DRWN: GGUNAGI		2016/11/09			
				APPR: ISHWARG		2016/12/06			
ANGULAR TOL ± 3.0°				THIRD ANGLE PROJECTION		DRAWING		SHEET NUMBER	
DRAFT WHERE APPLICABLE MUST REMAIN WITHIN DIMENSIONS						A3-SIZE		5 OF 21	

DOCUMENT STATUS	P1	RELEASE DATE	2021/10/11	11:53:29
-----------------	----	--------------	------------	----------

PACKAGING OPTION PART NO.						CKT SIZE	VOID POSITION	PLATING TYPE	DIMENSION				
TRAY WITHOUT CAP	TRAY WITH CAP	TUBE WITHOUT CAP	TUBE WITH CAP	TAPE & REEL WITHOUT CAP	TAPE & REEL WITH CAP				A	B	G	F	M
-----	-----	87898-1321	87898-1331	-----	87898-1351	13	-----	1	33.02	30.48	10.81	9.65	5.84
-----	-----	87898-1322	87898-1332	-----	87898-1352	13	-----	2	33.02	30.48	10.81	9.65	5.84
-----	-----	87898-1324	87898-1334	-----	87898-1354	13	-----	4	33.02	30.48	10.81	9.65	5.84
-----	-----	87898-1325	87898-1335	-----	87898-1355	13	-----	5	33.02	30.48	10.81	9.65	5.84
-----	-----	87898-1326	87898-1336	-----	87898-1356	13	-----	6	33.02	30.48	10.81	9.65	5.84
-----	-----	87898-1421	87898-1431	-----	87898-1451	14	-----	1	35.56	33.02	10.81	9.65	5.84
-----	-----	87898-1422	87898-1432	-----	87898-1452	14	-----	2	35.56	33.02	10.81	9.65	5.84
-----	-----	87898-1424	87898-1434	-----	87898-1454	14	-----	4	35.56	33.02	10.81	9.65	5.84
-----	-----	87898-1425	87898-1435	-----	87898-1455	14	-----	5	35.56	33.02	10.81	9.65	5.84
-----	-----	87898-1426	87898-1436	-----	87898-1456	14	-----	6	35.56	33.02	10.81	9.65	5.84
-----	-----	87898-1427	87898-1437	-----	87898-1457	14	-----	6	35.56	33.02	10.81	9.65	5.84
-----	-----	87898-1521	87898-1531	-----	87898-1551	15	-----	1	38.10	35.56	10.81	9.65	5.84
-----	-----	87898-1522	87898-1532	-----	87898-1552	15	-----	2	38.10	35.56	10.81	9.65	5.84
-----	-----	87898-1524	87898-1534	-----	87898-1554	15	-----	4	38.10	35.56	10.81	9.65	5.84
-----	-----	87898-1525	87898-1535	-----	87898-1555	15	-----	5	38.10	35.56	10.81	9.65	5.84
-----	-----	87898-1526	87898-1536	-----	87898-1556	15	-----	6	38.10	35.56	10.81	9.65	5.84

(B24)

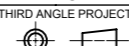
THIS DRAWING CONTAINS INFORMATION THAT IS PROPRIETARY TO MOLEX ELECTRONIC TECHNOLOGIES, LLC AND SHOULD NOT BE USED WITHOUT WRITTEN PERMISSION																	
DIMENSION UNITS		SCALE		CURRENT REV DESC: BRIGHT TIN PHASE OUT													
mm		NTS		EC NO: 679909 DRWN: AKUMAR19 2021/06/29 CHK'D: MRAMAKRISHNA 2021/10/11 APPR: MRAMAKRISHNA 2021/10/11 INITIAL REVISION: DRWN: GGUNAGI 2016/11/09 APPR: ISHWARG 2016/12/06								CUSTOMER					
GENERAL TOLERANCES (UNLESS SPECIFIED)										CUSTOMER						DOC TYPE	
										2.54MM PITCH SINGLE ROW SINGLE WAFER SMT HEADER						DOC PART	
										PRODUCT CUSTOMER DRAWING						REVISION	
4 PLACES ±										SD-87898-001						000	
3 PLACES ±																B24	
2 PLACES ± 0.2																	
1 PLACE ±																	
0 PLACES ±																	
ANGULAR TOL ± 3.0°				THIRD ANGLE PROJECTION						DRAWING							
DRAFT WHERE APPLICABLE MUST REMAIN WITHIN DIMENSIONS										SERIES							
				A3-SIZE						87898							
				MATERIAL NUMBER						CUSTOMER							
				SEE TABLE						GENERAL MARKET							
										SHEET NUMBER							
										6 OF 21							

DOCUMENT STATUS	P1	RELEASE DATE	2021/10/11	11:53:29
-----------------	----	--------------	------------	----------

PACKAGING OPTION PART NO.										DIMENSION				
TRAY WITHOUT CAP	TRAY WITH CAP	TUBE WITHOUT CAP	TUBE WITH CAP	TAPE & REEL WITHOUT CAP	TAPE & REEL WITH CAP	CKT SIZE	VOID POSITION	PLATING TYPE	A	B	G	F	M	
-----	-----	87898-1621	87898-1631	-----	87898-1651	16	----	1	40.64	38.10	10.81	9.65	5.84	
-----	-----	87898-1622	87898-1632	-----	87898-1652	16	----	2	40.64	38.10	10.81	9.65	5.84	
-----	-----	87898-1624	87898-1634	-----	87898-1654	16	----	4	40.64	38.10	10.81	9.65	5.84	
-----	-----	87898-1625	87898-1635	-----	87898-1655	16	----	5	40.64	38.10	10.81	9.65	5.84	
-----	-----	87898-1626	87898-1636	-----	87898-1656	16	----	6	40.64	38.10	10.81	9.65	5.84	
-----	-----	87898-1627	87898-1637	-----	87898-1657	16	----	6	40.64	38.10	10.81	9.65	5.84	
-----	-----	87898-1721	87898-1731	-----	87898-1751	17	----	1	43.18	40.64	10.81	9.65	5.84	
-----	-----	87898-1722	87898-1732	-----	87898-1752	17	----	2	43.18	40.64	10.81	9.65	5.84	
-----	-----	87898-1724	87898-1734	-----	87898-1754	17	----	4	43.18	40.64	10.81	9.65	5.84	
-----	-----	87898-1725	87898-1735	-----	87898-1755	17	----	5	43.18	40.64	10.81	9.65	5.84	
-----	-----	87898-1726	87898-1736	-----	87898-1756	17	----	6	43.18	40.64	10.81	9.65	5.84	
-----	-----	87898-1821	87898-1831	-----	87898-1851	18	----	1	45.72	43.18	10.81	9.65	5.84	
-----	-----	87898-1822	87898-1832	-----	87898-1852	18	----	2	45.72	43.18	10.81	9.65	5.84	
-----	-----	87898-1824	87898-1834	-----	87898-1854	18	----	4	45.72	43.18	10.81	9.65	5.84	
-----	-----	87898-1825	87898-1835	-----	87898-1855	18	----	5	45.72	43.18	10.81	9.65	5.84	
-----	-----	87898-1826	87898-1836	-----	87898-1856	18	----	6	45.72	43.18	10.81	9.65	5.84	
-----	-----	87898-1827	87898-1837	-----	87898-1857	18	----	6	45.72	43.18	10.81	9.65	5.84	

B24

B24

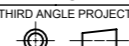
THIS DRAWING CONTAINS INFORMATION THAT IS PROPRIETARY TO MOLEX ELECTRONIC TECHNOLOGIES, LLC AND SHOULD NOT BE USED WITHOUT WRITTEN PERMISSION									
DIMENSION UNITS		SCALE		CURRENT REV DESC: BRIGHT TIN PHASE OUT					
mm		NTS							
GENERAL TOLERANCES (UNLESS SPECIFIED)				EC NO: 679909		CUSTOMER		CUSTOMER	
				DRWN: AKUMAR19		2021/06/29		2.54MM PITCH SINGLE ROW SINGLE WAFER SMT HEADER	
				CHK'D: MRAMAKRISHNA		2021/10/11		PRODUCT CUSTOMER DRAWING	
				APPR: MRAMAKRISHNA		2021/10/11			
				INITIAL REVISION:					
4 PLACES ±				DRWN: GGUNAGI		2016/11/09		DOCUMENT NUMBER	
3 PLACES ±				APPR: ISHWARG		2016/12/06		SD-87898-001	
2 PLACES ± 0.2								DOC TYPE	
1 PLACE ±								PSD	
0 PLACES ±								DOC PART	
ANGULAR TOL ± 3.0°								000	
DRAFT WHERE APPLICABLE MUST REMAIN WITHIN DIMENSIONS				THIRD ANGLE PROJECTION		DRAWING		SERIES	
						A3-SIZE		87898	
						MATERIAL NUMBER		CUSTOMER	
						SEE TABLE		GENERAL MARKET	
								REVISION	
								B24	
								SHEET NUMBER	
								7 OF 21	

PACKAGING OPTION PART NO.						CKT SIZE	VOID POSITION	PLATING TYPE	DIMENSION				
TRAY WITHOUT CAP	TRAY WITH CAP	TUBE WITHOUT CAP	TUBE WITH CAP	TAPE & REEL WITHOUT CAP	TAPE & REEL WITH CAP				A	B	G	F	M
-----	-----	87898-1921	87898-1931	-----	87898-1951	19	-----	1	48.26	45.72	10.81	9.65	5.84
-----	-----	87898-1922	87898-1932	-----	87898-1952	19	-----	2	48.26	45.72	10.81	9.65	5.84
-----	-----	87898-1924	87898-1934	-----	87898-1954	19	-----	4	48.26	45.72	10.81	9.65	5.84
-----	-----	87898-1925	87898-1935	-----	87898-1955	19	-----	5	48.26	45.72	10.81	9.65	5.84
-----	-----	87898-1926	87898-1936	-----	87898-1956	19	-----	6	48.26	45.72	10.81	9.65	5.84
-----	-----	87898-2021	87898-2031	-----	87898-2051	20	-----	1	50.80	48.26	10.81	9.65	5.84
-----	-----	87898-2022	87898-2032	-----	87898-2052	20	-----	2	50.80	48.26	10.81	9.65	5.84
-----	-----	87898-2024	87898-2034	-----	87898-2054	20	-----	4	50.80	48.26	10.81	9.65	5.84
-----	-----	87898-2025	87898-2035	-----	87898-2055	20	-----	5	50.80	48.26	10.81	9.65	5.84
-----	-----	87898-2026	87898-2036	-----	87898-2056	20	-----	6	50.80	48.26	10.81	9.65	5.84
-----	-----	87898-2027	87898-2037	-----	87898-2057	20	-----	6	50.80	48.26	10.81	9.65	5.84
-----	-----	87898-2121	87898-2131	-----	87898-2151	21	-----	1	53.34	50.80	10.81	9.65	5.84
-----	-----	87898-2122	87898-2132	-----	87898-2152	21	-----	2	53.34	50.80	10.81	9.65	5.84
-----	-----	87898-2124	87898-2134	-----	87898-2154	21	-----	4	53.34	50.80	10.81	9.65	5.84
-----	-----	87898-2125	87898-2135	-----	87898-2155	21	-----	5	53.34	50.80	10.81	9.65	5.84
-----	-----	87898-2126	87898-2136	-----	87898-2156	21	-----	6	53.34	50.80	10.81	9.65	5.84

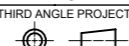
THIS DRAWING CONTAINS INFORMATION THAT IS PROPRIETARY TO MOLEX ELECTRONIC TECHNOLOGIES, LLC AND SHOULD NOT BE USED WITHOUT WRITTEN PERMISSION																
DIMENSION UNITS		SCALE		CURRENT REV DESC: BRIGHT TIN PHASE OUT												
mm		NTS														
GENERAL TOLERANCES (UNLESS SPECIFIED)				EC NO: 679909 DRWN: AKUMAR19 2021/06/29 CHK'D: MRAMAKRISHNA 2021/10/11 APPR: MRAMAKRISHNA 2021/10/11 INITIAL REVISION: DRWN: GGUNAGI 2016/11/09 APPR: ISHWARG 2016/12/06						CUSTOM HEADER 2.54MM PITCH SINGLE ROW SINGLE WAFER SMT HEADER						
												PRODUCT CUSTOMER DRAWING				
4 PLACES ±		±								DOCUMENT NUMBER SD-87898-001				DOC TYPE	DOC PART	REVISION
3 PLACES ±		±												PSD	000	B24
2 PLACES ±		0.2 ±														
1 PLACE ±		±		MATERIAL NUMBER SEE TABLE		CUSTOMER GENERAL MARKET		SHEET NUMBER 8 OF 21								
0 PLACES ±		±														
ANGULAR TOL ± 3.0°				THIRD ANGLE PROJECTION		DRAWING	SERIES	MATERIAL NUMBER	CUSTOMER							
DRAFT WHERE APPLICABLE MUST REMAIN WITHIN DIMENSIONS						A3-SIZE	87898									

DOCUMENT STATUS	P1	RELEASE DATE	2021/10/11	11:53:29
-----------------	----	--------------	------------	----------

PACKAGING OPTION PART NO.						CKT SIZE	VOID POSITION	PLATING TYPE	DIMENSION				
TRAY WITHOUT CAP	TRAY WITH CAP	TUBE WITHOUT CAP	TUBE WITH CAP	TAPE & REEL WITHOUT CAP	TAPE & REEL WITH CAP				A	B	G	F	M
-----	-----	87898-2221	87898-2231	-----	-----	22	----	1	55.88	53.34	10.81	9.65	5.84
-----	-----	87898-2222	87898-2232	-----	-----	22	----	2	55.88	53.34	10.81	9.65	5.84
-----	-----	87898-2224	87898-2234	-----	-----	22	----	4	55.88	53.34	10.81	9.65	5.84
-----	-----	87898-2225	87898-2235	-----	-----	22	----	5	55.88	53.34	10.81	9.65	5.84
-----	-----	87898-2226	87898-2236	-----	-----	22	----	6	55.88	53.34	10.81	9.65	5.84
-----	-----	87898-2321	87898-2331	-----	-----	23	----	1	58.42	55.88	10.81	9.65	5.84
-----	-----	87898-2322	87898-2332	-----	-----	23	----	2	58.42	55.88	10.81	9.65	5.84
-----	-----	87898-2324	87898-2334	-----	-----	23	----	4	58.42	55.88	10.81	9.65	5.84
-----	-----	87898-2325	87898-2335	-----	-----	23	----	5	58.42	55.88	10.81	9.65	5.84
-----	-----	87898-2326	87898-2336	-----	-----	23	----	6	58.42	55.88	10.81	9.65	5.84
-----	-----	87898-2421	87898-2431	-----	-----	24	----	1	60.96	58.42	10.81	9.65	5.84
-----	-----	87898-2422	87898-2432	-----	-----	24	----	2	60.96	58.42	10.81	9.65	5.84
-----	-----	87898-2424	87898-2434	-----	-----	24	----	4	60.96	58.42	10.81	9.65	5.84
-----	-----	87898-2425	87898-2435	-----	-----	24	----	5	60.96	58.42	10.81	9.65	5.84
-----	-----	87898-2426	87898-2436	-----	-----	24	----	6	60.96	58.42	10.81	9.65	5.84
-----	-----	87898-2427	87898-2437	-----	-----	24	----	6	60.96	58.42	10.81	9.65	5.84

B24

THIS DRAWING CONTAINS INFORMATION THAT IS PROPRIETARY TO MOLEX ELECTRONIC TECHNOLOGIES, LLC AND SHOULD NOT BE USED WITHOUT WRITTEN PERMISSION									
DIMENSION UNITS		SCALE		CURRENT REV DESC: BRIGHT TIN PHASE OUT					
mm		NTS							
GENERAL TOLERANCES (UNLESS SPECIFIED)				EC NO: 679909		CUSTOM HEADER		2.54MM PITCH SINGLE ROW SINGLE WAFER SMT HEADER	
				DRWN: AKUMAR19		2021/06/29			
				CHK'D: MRAMAKRISHNA		2021/10/11			
				APPR: MRAMAKRISHNA		2021/10/11			
				INITIAL REVISION:		DOCUMENT NUMBER		DOC TYPE	
				DRWN: GGUNAGI		2016/11/09		SD-87898-001	
				APPR: ISHWARG		2016/12/06		PSD	
				ANGULAR TOL ± 3.0°				000	
				DRAFT WHERE APPLICABLE MUST REMAIN WITHIN DIMENSIONS		THIRD ANGLE PROJECTION		DRAWING	
						A3-SIZE		SERIES	
						87898		MATERIAL NUMBER	
						SEE TABLE		CUSTOMER	
						GENERAL MARKET		REVISION	
								B24	
								SHEET NUMBER	
								9 OF 21	

DOCUMENT STATUS	P1	RELEASE DATE	2021/10/11	11:53:29
-----------------	----	--------------	------------	----------

PACKAGING OPTION PART NO.						CKT SIZE	VOID POSITION	PLATING TYPE	DIMENSION				
TRAY WITHOUT CAP	TRAY WITH CAP	TUBE WITHOUT CAP	TUBE WITH CAP	TAPE & REEL WITHOUT CAP	TAPE & REEL WITH CAP				A	B	G	F	M
-----	-----	87898-2521	87898-2531	-----	-----	25	----	1	63.50	60.96	10.81	9.65	5.84
-----	-----	87898-2522	87898-2532	-----	-----	25	----	2	63.50	60.96	10.81	9.65	5.84
-----	-----	87898-2524	87898-2534	-----	-----	25	----	4	63.50	60.96	10.81	9.65	5.84
-----	-----	87898-2525	87898-2535	-----	-----	25	----	5	63.50	60.96	10.81	9.65	5.84
-----	-----	87898-2526	87898-2536	-----	-----	25	----	6	63.50	60.96	10.81	9.65	5.84
-----	-----	87898-2621	87898-2631	-----	-----	26	----	1	66.04	63.50	10.81	9.65	5.84
-----	-----	87898-2622	87898-2632	-----	-----	26	----	2	66.04	63.50	10.81	9.65	5.84
-----	-----	87898-2624	87898-2634	-----	-----	26	----	4	66.04	63.50	10.81	9.65	5.84
-----	-----	87898-2625	87898-2635	-----	-----	26	----	5	66.04	63.50	10.81	9.65	5.84
-----	-----	87898-2626	87898-2636	-----	-----	26	----	6	66.04	63.50	10.81	9.65	5.84
-----	-----	87898-2627	87898-2637	-----	-----	26	----	6	66.04	63.50	10.81	9.65	5.84
-----	-----	87898-2721	87898-2731	-----	-----	27	----	1	68.58	66.04	10.81	9.65	5.84
-----	-----	87898-2722	87898-2732	-----	-----	27	----	2	68.58	66.04	10.81	9.65	5.84
-----	-----	87898-2724	87898-2734	-----	-----	27	----	4	68.58	66.04	10.81	9.65	5.84
-----	-----	87898-2725	87898-2735	-----	-----	27	----	5	68.58	66.04	10.81	9.65	5.84
-----	-----	87898-2726	87898-2736	-----	-----	27	----	6	68.58	66.04	10.81	9.65	5.84

(B24)

DOCUMENT STATUS	P1	RELEASE DATE	2021/10/11	11:53:29
-----------------	----	--------------	------------	----------

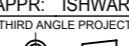
THIS DRAWING CONTAINS INFORMATION THAT IS PROPRIETARY TO MOLEX ELECTRONIC TECHNOLOGIES, LLC AND SHOULD NOT BE USED WITHOUT WRITTEN PERMISSION									
DIMENSION UNITS		SCALE		CURRENT REV DESC: BRIGHT TIN PHASE OUT					
mm		NTS		 <p>CUSTOM HEADER 2.54MM PITCH SINGLE ROW SINGLE WAFER SMT HEADER</p>					
GENERAL TOLERANCES (UNLESS SPECIFIED)									
		MM	INCH	EC NO: 679909 DRWN: AKUMAR19 2021/06/29 CHK'D: MRAMAKRISHNA 2021/10/11 APPR: MRAMAKRISHNA 2021/10/11 INITIAL REVISION: DRWN: GGUNAGI 2016/11/09 APPR: ISHWARG 2016/12/06					
4 PLACES	±	±	±						
3 PLACES	±	±	±						
2 PLACES	±	0.2	±						
1 PLACE	±	±	±						
0 PLACES	±	±	±	DOCUMENT NUMBER		DOC TYPE	DOC PART	REVISION	
ANGULAR TOL ± 3.0°				SD-87898-001		PSD	000	B24	
DRAFT WHERE APPLICABLE MUST REMAIN WITHIN DIMENSIONS				THIRD ANGLE PROJECTION	DRAWING	SERIES	MATERIAL NUMBER	CUSTOMER	SHEET NUMBER
					A3-SIZE	87898	SEE TABLE	GENERAL MARKET	10 OF 21

PACKAGING OPTION PART NO.						CKT SIZE	VOID POSITION	PLATING TYPE	DIMENSION				
TRAY WITHOUT CAP	TRAY WITH CAP	TUBE WITHOUT CAP	TUBE WITH CAP	TAPE & REEL WITHOUT CAP	TAPE & REEL WITH CAP				A	B	G	F	M
-----	-----	87898-2821	87898-2831	-----	-----	28	-----	1	71.12	68.58	10.81	9.65	5.84
-----	-----	87898-2822	87898-2832	-----	-----	28	-----	2	71.12	68.58	10.81	9.65	5.84
-----	-----	87898-2824	87898-2834	-----	-----	28	-----	4	71.12	68.58	10.81	9.65	5.84
-----	-----	87898-2825	87898-2835	-----	-----	28	-----	5	71.12	68.58	10.81	9.65	5.84
-----	-----	87898-2826	87898-2836	-----	-----	28	-----	6	71.12	68.58	10.81	9.65	5.84
-----	-----	87898-2921	87898-2931	-----	-----	29	-----	1	73.66	71.12	10.81	9.65	5.84
-----	-----	87898-2922	87898-2932	-----	-----	29	-----	2	73.66	71.12	10.81	9.65	5.84
-----	-----	87898-2924	87898-2934	-----	-----	29	-----	4	73.66	71.12	10.81	9.65	5.84
-----	-----	87898-2925	87898-2935	-----	-----	29	-----	5	73.66	71.12	10.81	9.65	5.84
-----	-----	87898-2926	87898-2936	-----	-----	29	-----	6	73.66	71.12	10.81	9.65	5.84
-----	-----	87898-3021	87898-3031	-----	-----	30	-----	1	76.20	73.66	10.81	9.65	5.84
-----	-----	87898-3022	87898-3032	-----	-----	30	-----	2	76.20	73.66	10.81	9.65	5.84
-----	-----	87898-3024	87898-3034	-----	-----	30	-----	4	76.20	73.66	10.81	9.65	5.84
-----	-----	87898-3025	87898-3035	-----	-----	30	-----	5	76.20	73.66	10.81	9.65	5.84
-----	-----	87898-3026	87898-3036	-----	-----	30	-----	6	76.20	73.66	10.81	9.65	5.84

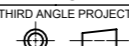
THIS DRAWING CONTAINS INFORMATION THAT IS PROPRIETARY TO MOLEX ELECTRONIC TECHNOLOGIES, LLC AND SHOULD NOT BE USED WITHOUT WRITTEN PERMISSION																	
DIMENSION UNITS		SCALE		CURRENT REV DESC: BRIGHT TIN PHASE OUT													
mm		NTS		EC NO: 679909 DRWN: AKUMAR19 2021/06/29 CHK'D: MRAMAKRISHNA 2021/10/11 APPR: MRAMAKRISHNA 2021/10/11 INITIAL REVISION: DRWN: GGUNAGI 2016/11/09 APPR: ISHWARG 2016/12/06								CUSTOMER					
GENERAL TOLERANCES (UNLESS SPECIFIED)										CUSTOMER						DOC TYPE	
										2.54MM PITCH SINGLE ROW SINGLE WAFER SMT HEADER						DOC PART	
										PRODUCT CUSTOMER DRAWING						REVISION	
4 PLACES ±										SD-87898-001						000	
3 PLACES ±																B24	
2 PLACES ± 0.2																	
1 PLACE ±																	
0 PLACES ±																	
ANGULAR TOL ± 3.0°																	
DRAFT WHERE APPLICABLE MUST REMAIN WITHIN DIMENSIONS				THIRD ANGLE PROJECTION		DRAWING		SERIES		MATERIAL NUMBER							
						A3-SIZE		87898		SEE TABLE							
								GENERAL MARKET		SHEET NUMBER							
										11 OF 21							

DOCUMENT STATUS	P1	RELEASE DATE	2021/10/11	11:53:29
-----------------	----	--------------	------------	----------

PACKAGING OPTION PART NO.						CKT SIZE	VOID POSITION	PLATING TYPE	DIMENSION				
TRAY WITHOUT CAP	TRAY WITH CAP	TUBE WITHOUT CAP	TUBE WITH CAP	TAPE & REEL WITHOUT CAP	TAPE & REEL WITH CAP				A	B	G	F	M
-----	-----	87898-3121	87898-3131	-----	-----	31	----	1	78.74	76.20	10.81	9.65	5.84
-----	-----	87898-3122	87898-3132	-----	-----	31	----	2	78.74	76.20	10.81	9.65	5.84
-----	-----	87898-3124	87898-3134	-----	-----	31	----	4	78.74	76.20	10.81	9.65	5.84
-----	-----	87898-3125	87898-3135	-----	-----	31	----	5	78.74	76.20	10.81	9.65	5.84
-----	-----	87898-3126	87898-3136	-----	-----	31	----	6	78.74	76.20	10.81	9.65	5.84
-----	-----	87898-3221	87898-3231	-----	-----	32	----	1	81.28	78.74	10.81	9.65	5.84
-----	-----	87898-3222	87898-3232	-----	-----	32	----	2	81.28	78.74	10.81	9.65	5.84
-----	-----	87898-3224	87898-3234	-----	-----	32	----	4	81.28	78.74	10.81	9.65	5.84
-----	-----	87898-3225	87898-3235	-----	-----	32	----	5	81.28	78.74	10.81	9.65	5.84
-----	-----	87898-3226	87898-3236	-----	-----	32	----	6	81.28	78.74	10.81	9.65	5.84
-----	-----	87898-3227	87898-3237	-----	-----	32	----	6	81.28	78.74	10.81	9.65	5.84
-----	-----	87898-3321	87898-3331	-----	-----	33	----	1	83.82	81.28	10.81	9.65	5.84
-----	-----	87898-3322	87898-3332	-----	-----	33	----	2	83.82	81.28	10.81	9.65	5.84
-----	-----	87898-3324	87898-3334	-----	-----	33	----	4	83.82	81.28	10.81	9.65	5.84
-----	-----	87898-3325	87898-3335	-----	-----	33	----	5	83.82	81.28	10.81	9.65	5.84
-----	-----	87898-3326	87898-3336	-----	-----	33	----	6	83.82	81.28	10.81	9.65	5.84

(B24)

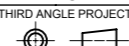
THIS DRAWING CONTAINS INFORMATION THAT IS PROPRIETARY TO MOLEX ELECTRONIC TECHNOLOGIES, LLC AND SHOULD NOT BE USED WITHOUT WRITTEN PERMISSION													
DIMENSION UNITS		SCALE		CURRENT REV DESC: BRIGHT TIN PHASE OUT									
mm		NTS											
GENERAL TOLERANCES (UNLESS SPECIFIED)				EC NO: 679909		DRWN: AKUMAR19		2021/06/29		CUSTOM HEADER 2.54MM PITCH SINGLE ROW SINGLE WAFER SMT HEADER			
				CHK'D: MRAMAKRISHNA		2021/10/11							
				APPR: MRAMAKRISHNA		2021/10/11		PRODUCT CUSTOMER DRAWING					
				INITIAL REVISION:				DOCUMENT NUMBER		DOC TYPE		DOC PART	
				DRWN: GGUNAGI		2016/11/09		SD-87898-001		PSD		000	
				APPR: ISHWARG		2016/12/06						B24	
ANGULAR TOL ± 3.0°				THIRD ANGLE PROJECTION		DRAWING		SERIES		MATERIAL NUMBER		CUSTOMER	
DRAFT WHERE APPLICABLE MUST REMAIN WITHIN DIMENSIONS						A3-SIZE		87898		SEE TABLE		GENERAL MARKET	
												SHEET NUMBER	
												12 OF 21	

DOCUMENT STATUS	P1	RELEASE DATE	2021/10/11	11:53:29
-----------------	----	--------------	------------	----------

PACKAGING OPTION PART NO.						CKT SIZE	VOID POSITION	PLATING TYPE	DIMENSION				
TRAY WITHOUT CAP	TRAY WITH CAP	TUBE WITHOUT CAP	TUBE WITH CAP	TAPE & REEL WITHOUT CAP	TAPE & REEL WITH CAP				A	B	G	F	M
-----	-----	87898-3721	87898-3731	-----	-----	37	----	1	93.98	91.44	10.81	9.65	5.84
-----	-----	87898-3722	87898-3732	-----	-----	37	----	2	93.98	91.44	10.81	9.65	5.84
-----	-----	87898-3724	87898-3734	-----	-----	37	----	4	93.98	91.44	10.81	9.65	5.84
-----	-----	87898-3725	87898-3735	-----	-----	37	----	5	93.98	91.44	10.81	9.65	5.84
-----	-----	87898-3726	87898-3736	-----	-----	37	----	6	93.98	91.44	10.81	9.65	5.84
-----	-----	87898-3821	87898-3831	-----	-----	38	----	1	96.52	93.98	10.81	9.65	5.84
-----	-----	87898-3822	87898-3832	-----	-----	38	----	2	96.52	93.98	10.81	9.65	5.84
-----	-----	87898-3824	87898-3834	-----	-----	38	----	4	96.52	93.98	10.81	9.65	5.84
-----	-----	87898-3825	87898-3835	-----	-----	38	----	5	96.52	93.98	10.81	9.65	5.84
-----	-----	87898-3826	87898-3836	-----	-----	38	----	6	96.52	93.98	10.81	9.65	5.84
-----	-----	87898-3921	87898-3931	-----	-----	39	----	1	99.06	96.52	10.81	9.65	5.84
-----	-----	87898-3922	87898-3932	-----	-----	39	----	2	99.06	96.52	10.81	9.65	5.84
-----	-----	87898-3924	87898-3934	-----	-----	39	----	4	99.06	96.52	10.81	9.65	5.84
-----	-----	87898-3925	87898-3935	-----	-----	39	----	5	99.06	96.52	10.81	9.65	5.84
-----	-----	87898-3926	87898-3936	-----	-----	39	----	6	99.06	96.52	10.81	9.65	5.84

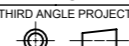
THIS DRAWING CONTAINS INFORMATION THAT IS PROPRIETARY TO MOLEX ELECTRONIC TECHNOLOGIES, LLC AND SHOULD NOT BE USED WITHOUT WRITTEN PERMISSION											
DIMENSION UNITS		SCALE		CURRENT REV DESC: BRIGHT TIN PHASE OUT							
mm		NTS									
GENERAL TOLERANCES (UNLESS SPECIFIED)				EC NO: 679909		DRWN: AKUMAR19		2021/06/29		CUSTOM HEADER 2.54MM PITCH SINGLE ROW SINGLE WAFER SMT HEADER	
				CHK'D: MRAMAKRISHNA		2021/10/11					
				APPR: MRAMAKRISHNA		2021/10/11		PRODUCT CUSTOMER DRAWING			
4 PLACES ±				INITIAL REVISION:		DRWN: GGUNAGI		2016/11/09		DOCUMENT NUMBER	
3 PLACES ±				DRWN: GGUNAGI		2016/12/06		SD-87898-001		DOC TYPE	
2 PLACES ± 0.2				APPR: ISHWARG				PSD		DOC PART	
1 PLACE ±								000		REVISION	
0 PLACES ±								B24			
ANGULAR TOL ± 3.0°				THIRD ANGLE PROJECTION		DRAWING		SERIES		MATERIAL NUMBER	
DRAFT WHERE APPLICABLE MUST REMAIN WITHIN DIMENSIONS						A3-SIZE		87898		CUSTOMER	
								SEE TABLE		GENERAL MARKET	
										SHEET NUMBER	
										14 OF 21	

DOCUMENT STATUS	P1	RELEASE DATE	2021/10/11	11:53:29
-----------------	----	--------------	------------	----------

PACKAGING OPTION PART NO.						CKT SIZE	VOID POSITION	PLATING TYPE	DIMENSION				
TRAY WITHOUT CAP	TRAY WITH CAP	TUBE WITHOUT CAP	TUBE WITH CAP	TAPE & REEL WITHOUT CAP	TAPE & REEL WITH CAP				A	B	G	F	M
-----	-----	87898-4021	87898-4031	-----	-----	40	-----	1	101.60	99.06	10.81	9.65	5.84
-----	-----	87898-4022	87898-4032	-----	-----	40	-----	2	101.60	99.06	10.81	9.65	5.84
-----	-----	87898-4024	87898-4034	-----	-----	40	-----	4	101.60	99.06	10.81	9.65	5.84
-----	-----	87898-4025	87898-4035	-----	-----	40	-----	5	101.60	99.06	10.81	9.65	5.84
-----	-----	87898-4026	87898-4036	-----	-----	40	-----	6	101.60	99.06	10.81	9.65	5.84

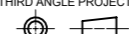
THIS DRAWING CONTAINS INFORMATION THAT IS PROPRIETARY TO MOLEX ELECTRONIC TECHNOLOGIES, LLC AND SHOULD NOT BE USED WITHOUT WRITTEN PERMISSION																
DIMENSION UNITS		SCALE		CURRENT REV DESC: BRIGHT TIN PHASE OUT												
mm		NTS														
GENERAL TOLERANCES (UNLESS SPECIFIED)				EC NO: 679909 DRWN: AKUMAR19 2021/06/29 CHK'D: MRAMAKRISHNA 2021/10/11 APPR: MRAMAKRISHNA 2021/10/11 INITIAL REVISION: DRWN: GGUNAGI 2016/11/09 APPR: ISHWARG 2016/12/06								CUSTOM HEADER				
												2.54MM PITCH SINGLE ROW SINGLE WAFER SMT HEADER				
												PRODUCT CUSTOMER DRAWING				
												DOCUMENT NUMBER		DOC TYPE	DOC PART	REVISION
												SD-87898-001		PSD	000	B24
												MATERIAL NUMBER		CUSTOMER		SHEET NUMBER
DRAFT WHERE APPLICABLE MUST REMAIN WITHIN DIMENSIONS				THIRD ANGLE PROJECTION		DRAWING	SERIES	MATERIAL NUMBER	CUSTOMER	SHEET NUMBER						
						A3-SIZE	87898	SEE TABLE	GENERAL MARKET	15 OF 21						

DOCUMENT STATUS	P1	RELEASE DATE	2021/10/11	11:53:29
-----------------	----	--------------	------------	----------

CAP ORIENTATION (CAP P/N: 87938-0001)

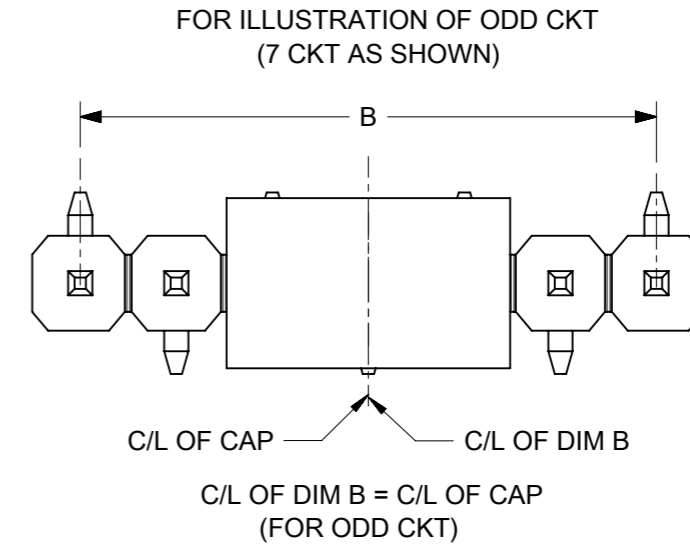
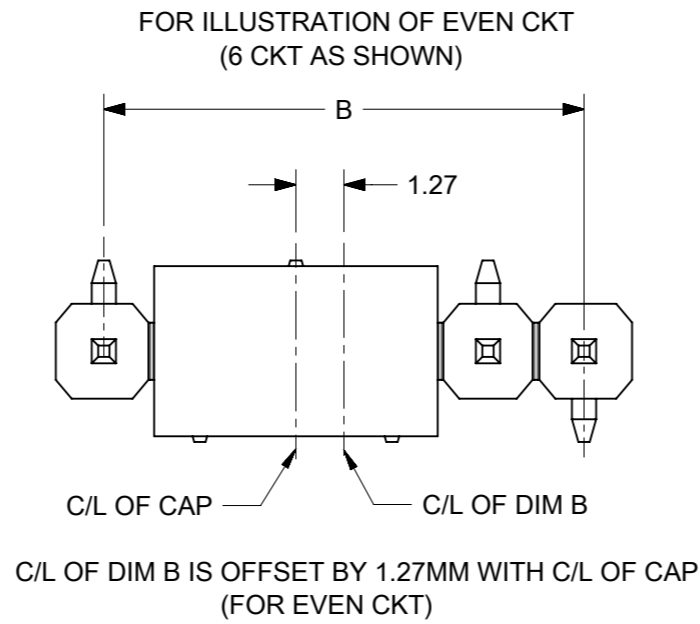

CAP ORIENTATION (CAP P/N: 87898-1000)

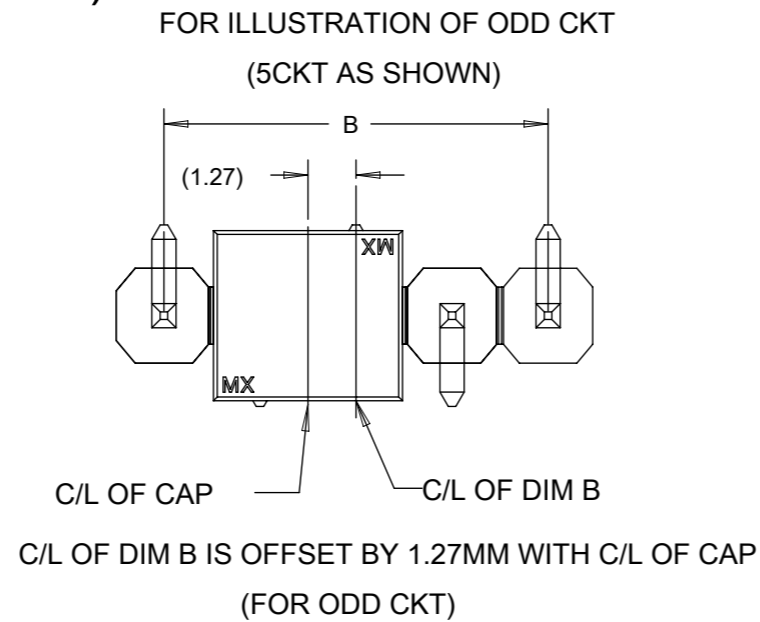

PART ORIENTATION IN TUBE

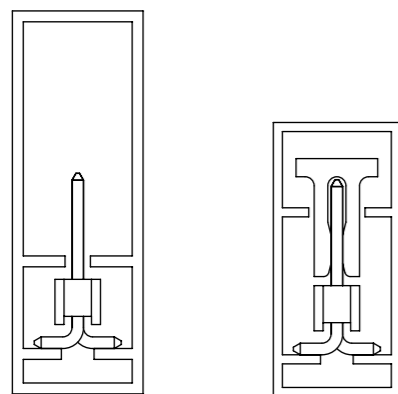

PART WITHOUT CAP PART WITH CAP

THIS DRAWING CONTAINS INFORMATION THAT IS PROPRIETARY TO MOLEX ELECTRONIC TECHNOLOGIES, LLC AND SHOULD NOT BE USED WITHOUT WRITTEN PERMISSION										
DIMENSION UNITS		SCALE		CURRENT REV DESC: BRIGHT TIN PHASE OUT						
mm		NTS								
GENERAL TOLERANCES (UNLESS SPECIFIED)										
		MM	INCH	CUSTOM HEADER 2.54MM PITCH SINGLE ROW SINGLE WAFER SMT HEADER PRODUCT CUSTOMER DRAWING						
4 PLACES	±	±	±							
3 PLACES	±	±	±							
2 PLACES	±	0.2	±							
1 PLACE	±	±	±							
0 PLACES	±	±	±	EC NO: 679909 DRWN: AKUMAR19 2021/06/29 CHK'D: MRAMAKRISHNA 2021/10/11 APPR: MRAMAKRISHNA 2021/10/11		DOCUMENT NUMBER SD-87898-001		DOC TYPE	DOC PART	REVISION
ANGULAR TOL		± 3.0°		INITIAL REVISION: DRWN: GGUNAGI 2016/11/09 APPR: ISHWARG 2016/12/06		MATERIAL NUMBER SEE TABLE		CUSTOMER GENERAL MARKET		SHEET NUMBER 16 OF 21
DRAFT WHERE APPLICABLE MUST REMAIN WITHIN DIMENSIONS				THIRD ANGLE PROJECTION		DRAWING	SERIES	87898		
						A3-SIZE				

EMBOSED CARRIER TYPE 'A'

CKT	DIMENSION				
	Bo	Ao	Ko	F	W
2	8.02	5.20	13.60	11.50	24.00
3	8.02	5.20	13.60	11.50	24.00
4	10.55	5.20	13.60	11.50	24.00

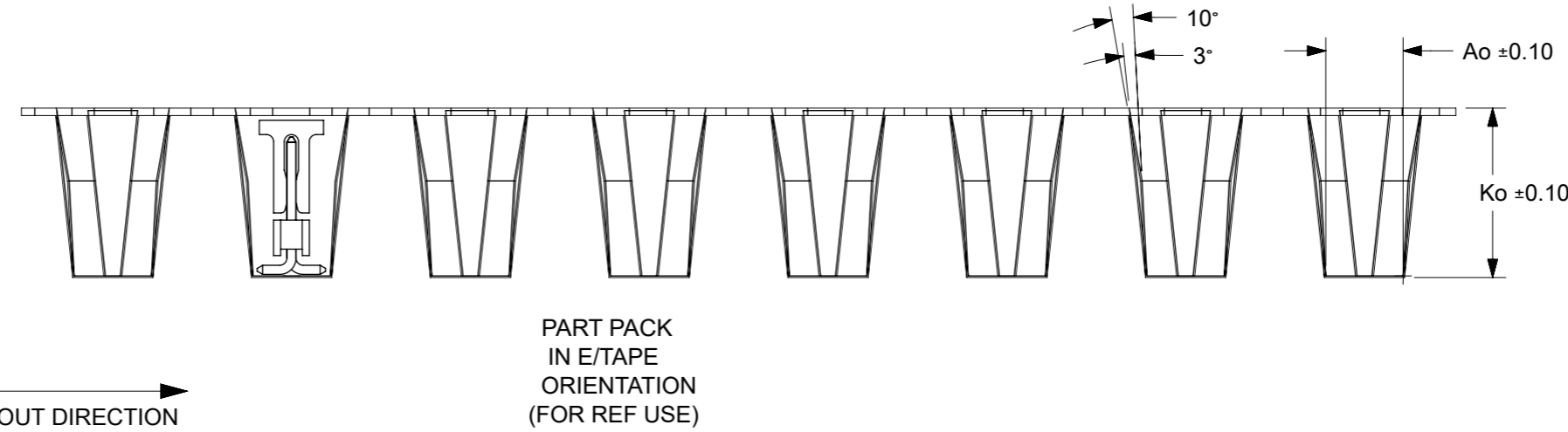
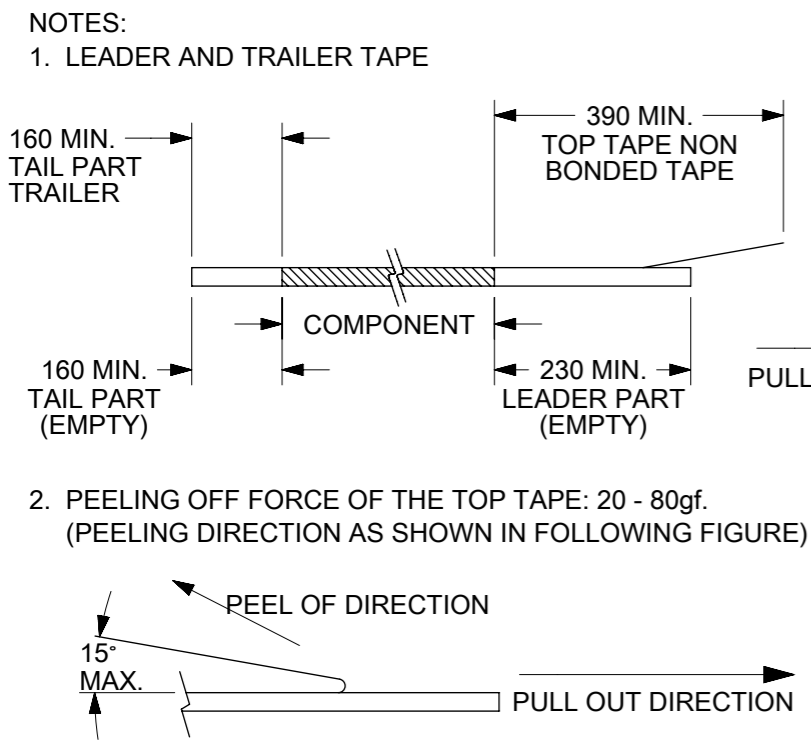
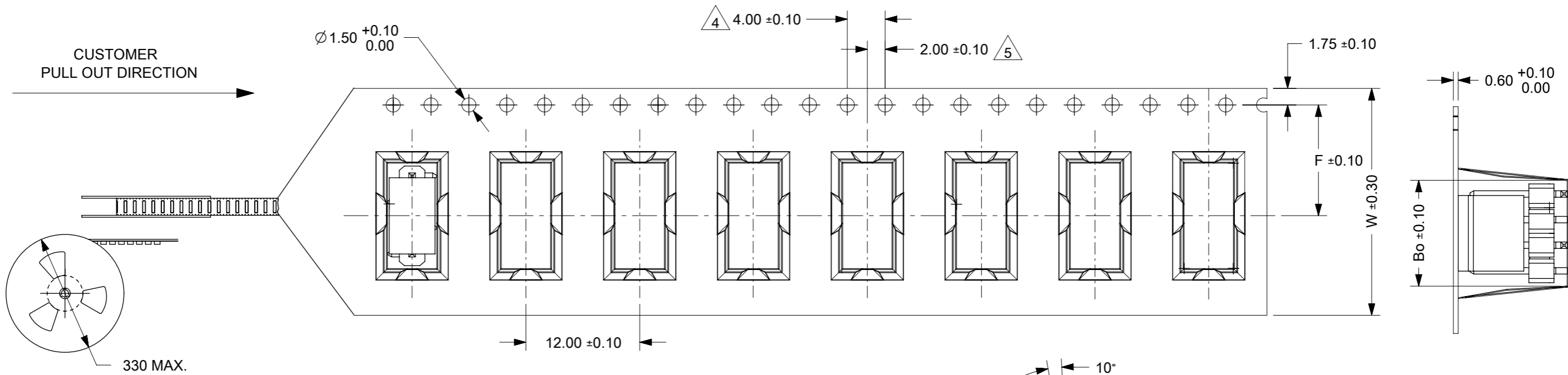

- MATERIAL: BLACK P.S CONDUCTIVE, BLACK
- MEASURED FROM CENTRELINE OF SPROCKET HOLE TO CENTRELINE OF SPOCKET
- CUMULATIVE TOLERANCE OF 10 SPROCKET HOLE IS ±0.20mm
- A0 AND B0 ARE MEASURE FROM ABOVE POCKET BASE 0.30mm
- TAPE AND REEL SPECIFICATION IS AS PER EIA-481.
- TAPE AND REEL QUANTITY : 440PCS/REEL
- THE TAPE IS TREATED FOR ANTI-STATIC.
- ALL RADIUS ARE 0.30MM UNLESS SPECIFY
- SURFACE RESISTIVITY 10³ TO 10 OHMS.

THIS DRAWING CONTAINS INFORMATION THAT IS PROPRIETARY TO MOLEX ELECTRONIC TECHNOLOGIES, LLC AND SHOULD NOT BE USED WITHOUT WRITTEN PERMISSION

DIMENSION UNITS	SCALE	CURRENT REV DESC: BRIGHT TIN PHASE OUT	
mm	NTS		
GENERAL TOLERANCES (UNLESS SPECIFIED)			
	MM	INCH	
4 PLACES	±	±	
3 PLACES	±	±	
2 PLACES	±	0.2	±
1 PLACE	±	±	±
0 PLACES	±	±	±
ANGULAR TOL	±	3.0°	
DRAFT WHERE APPLICABLE MUST REMAIN WITHIN DIMENSIONS	THIRD ANGLE PROJECTION	DRAWING	SERIES
		A3-SIZE	87898

EC NO: 679909		2021/06/29	
DRWN: AKUMAR19		2021/10/11	
CHK'D: MRAMAKRISHNA		2021/10/11	
APPR: MRAMAKRISHNA		2021/10/11	
INITIAL REVISION:			
DRWN: GGUNAGI		2016/11/09	
APPR: ISHWARG		2016/12/06	
DOCUMENT NUMBER	DOC TYPE	DOC PART	REVISION
SD-87898-001	PSD	000	B24
MATERIAL NUMBER	CUSTOMER	SHEET NUMBER	
SEE TABLE	GENERAL MARKET	17 OF 21	

CKT	DIMENSION				
	Bo	Ao	Ko	F	W
5	13.10	5.20	11.30	11.50	24.00

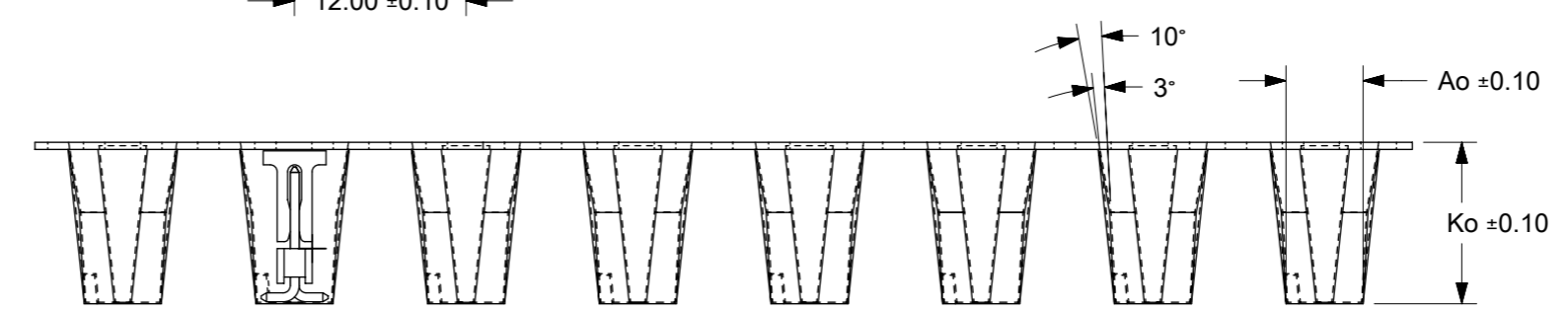

NOTES:
1. LEADER AND TRAILER TAPE

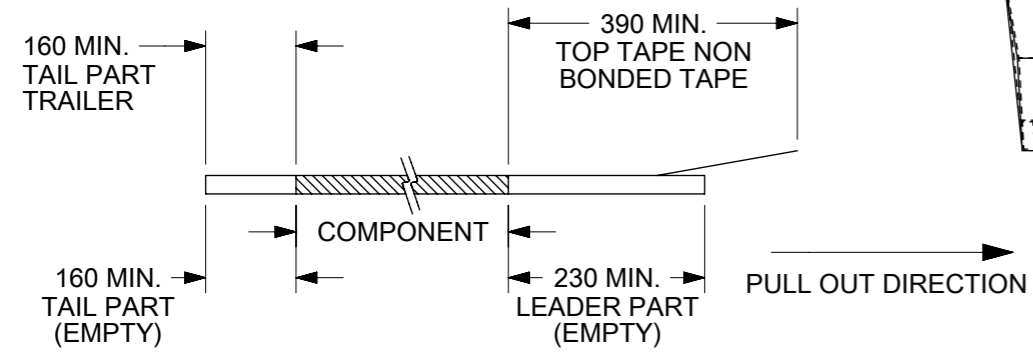

2. PEELING OFF FORCE OF THE TOP TAPE: 20 - 80gf.
(PEELING DIRECTION AS SHOWN IN FOLLOWING FIGURE)

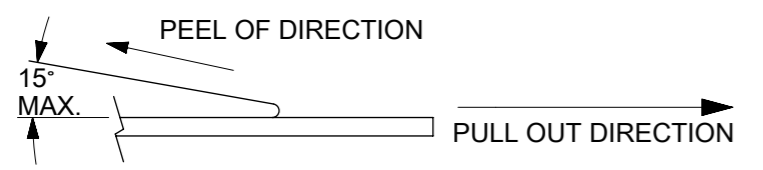

3. MATERIAL: BLACK P.S CONDUCTIVE, BLACK
4. MEASURED FROM CENTRELINE OF SPROCKET HOLE TO CENTRELINE OF SPOCKET
5. CUMULATIVE TOLERANCE OF 10 SPROCKET HOLE IS $\pm 0.20\text{mm}$
6. A0 AND B0 ARE MEASURE FROM ABOVE POCKET BASE 0.30mm
7. TAPE AND REEL SPECIFICATION IS AS PER EIA-481.
8. TAPE AND REEL QUANTITY : 440PCS/REEL
9. THE TAPE IS TREATED FOR ANTI-STATIC.
10. ALL RADIUS ARE 0.30MM UNLESS SPECIFY
11. SURFACE RESISTIVITY 10^3 TO 10 OHMS.

THIS DRAWING CONTAINS INFORMATION THAT IS PROPRIETARY TO MOLEX ELECTRONIC TECHNOLOGIES, LLC AND SHOULD NOT BE USED WITHOUT WRITTEN PERMISSION		CURRENT REV DESC: BRIGHT TIN PHASE OUT		molex	
CUSTOMER HEADER 2.54MM PITCH SINGLE ROW SINGLE WAFER SMT HEADER		PRODUCT CUSTOMER DRAWING			
EC NO: 679909		DRWN: AKUMAR19 2021/06/29		DOCUMENT NUMBER	
CHK'D: MRAMAKRISHNA		APPR: MRAMAKRISHNA 2021/10/11		SD-87898-001	
INITIAL REVISION:		DRWN: GGUNAGI 2016/11/09		DOC TYPE	
APPR: ISHWARG 2016/12/06		SERIES		DOC PART	
ANGULAR TOL $\pm 3.0^\circ$		DRAWING		REVISION	
DRAFT WHERE APPLICABLE MUST REMAIN WITHIN DIMENSIONS		THIRD ANGLE PROJECTION		MATERIAL NUMBER	
A3-SIZE		87898		CUSTOMER	
SEE TABLE		GENERAL MARKET		SHEET NUMBER	
18 OF 21					

10

F

E

D

C

B

A

9

8

7

6

5

4

3

2

1

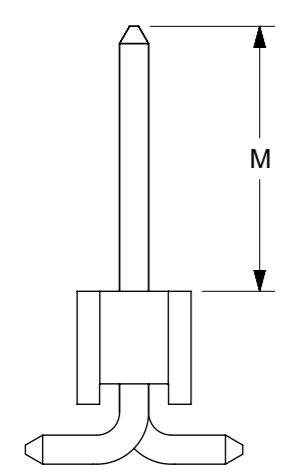
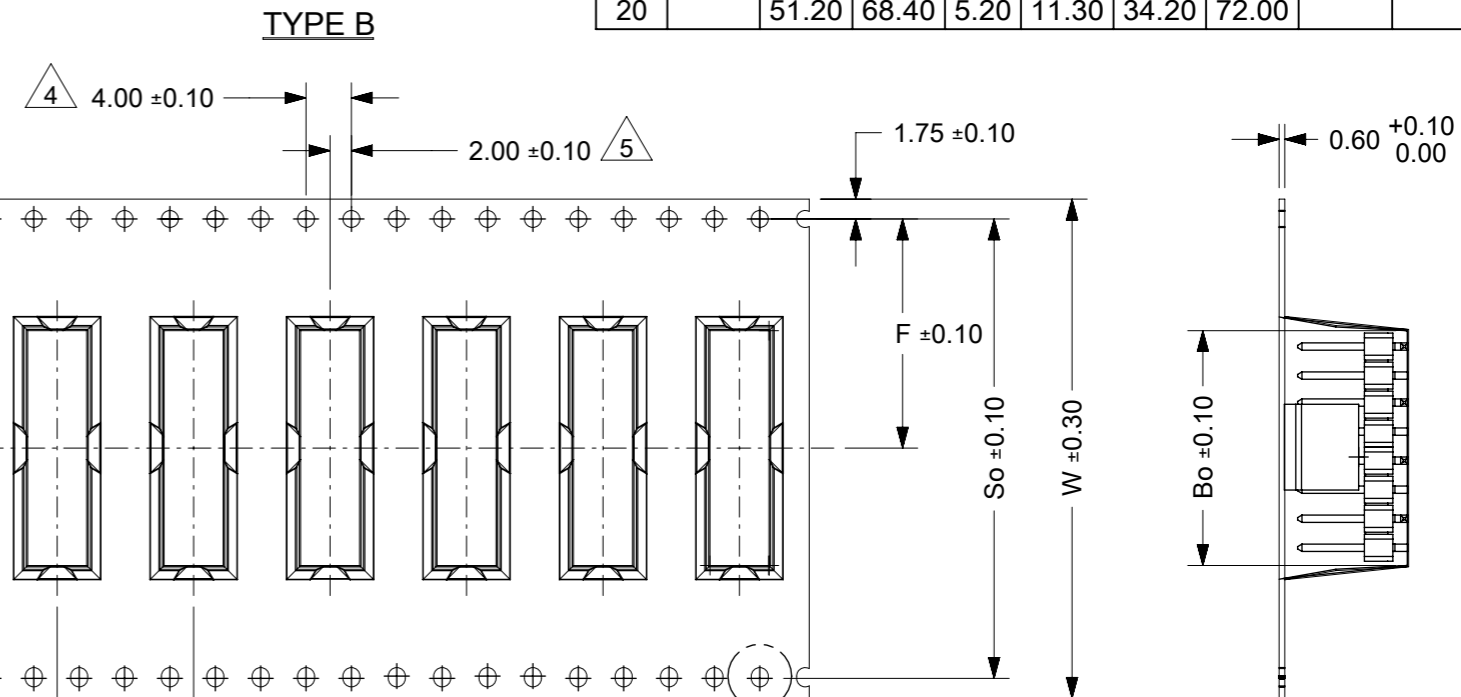
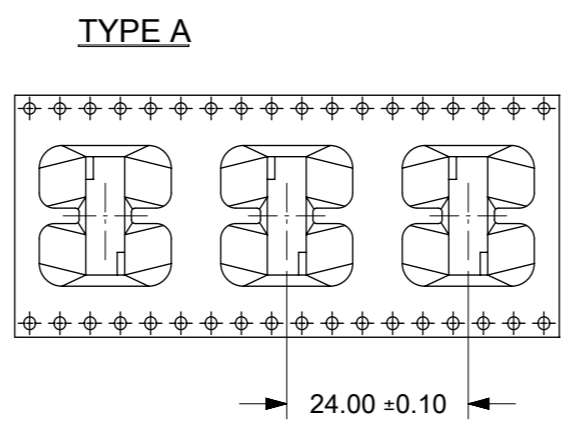
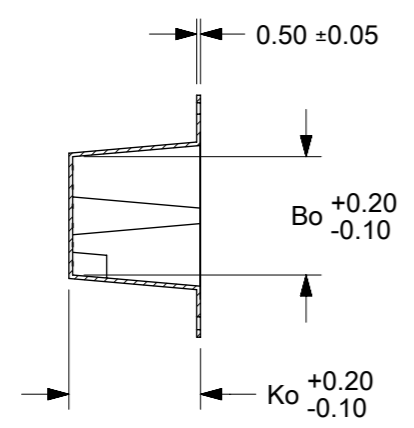

NOTES:
1. LEADER AND TRAILER TAPE

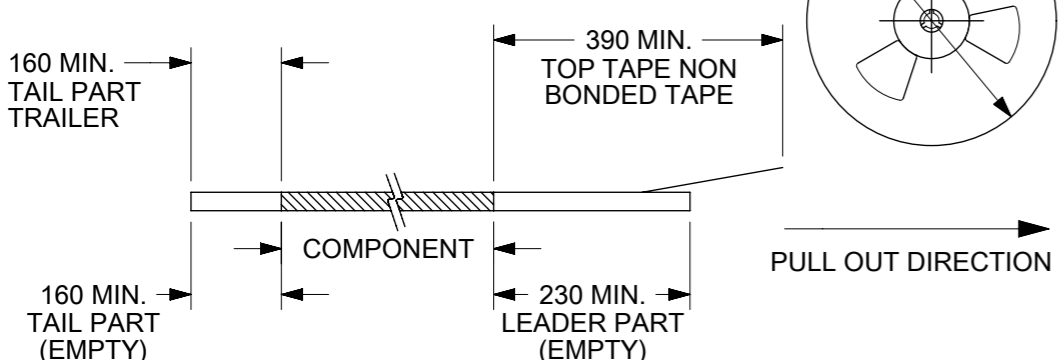

2. PEELING OFF FORCE OF THE TOP TAPE: 20 - 80gf.
(PEELING DIRECTION AS SHOWN IN FOLLOWING FIGURE)

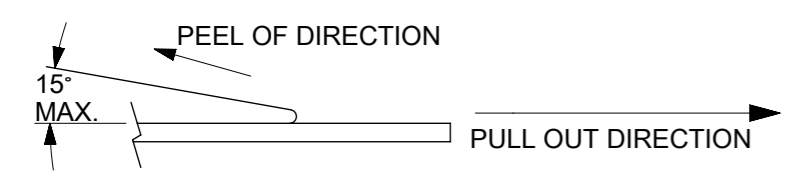

3. MATERIAL: BLACK P.S CONDUCTIVE, BLACK

4. MEASURED FROM CENTRELINE OF SPROCKET HOLE TO CENTRELINE OF SPOCKET

5. CUMULATIVE TOLERANCE OF 10 SPROCKET HOLE IS ±0.20mm

6. A0 AND B0 ARE MEASURE FROM ABOVE POCKET BASE 0.30mm

7. TAPE AND REEL SPECIFICATION IS AS PER EIA-481.

8. TAPE AND REEL QUANTITY : SEE TABLE

9. THE TAPE IS TREATED FOR ANTI-STATIC.

10. ALL RADIUS ARE 0.30MM UNLESS SPECIFY

11. SURFACE RESISTIVITY 10³ TO 10 OHMS.

CKT	DIMENSION							TYPE	QTY/ REEL
	M	Bo	So	Ao	Ko	F	W		
6	11.50	15.65	28.40	5.20	16.90	14.20	32.00	A	150
6	5.84	15.65	28.40	5.20	11.30	14.20	32.00	B	440
8		20.70	40.40	5.20	11.30	20.20	44.00		
10		25.80	40.40	5.20	11.30	20.20	44.00		
12		30.90	52.40	5.20	11.30	26.20	56.00		
14		35.95	52.40	5.20	11.30	26.20	56.00		
16		41.05	52.40	5.20	11.30	26.20	56.00		
18		46.20	68.40	5.20	11.30	34.20	72.00		
20		51.20	68.40	5.20	11.30	34.20	72.00		

DOCUMENT STATUS	P1	RELEASE DATE	2021/10/11	11:53:29
-----------------	----	--------------	------------	----------

THIS DRAWING CONTAINS INFORMATION THAT IS PROPRIETARY TO MOLEX ELECTRONIC TECHNOLOGIES, LLC AND SHOULD NOT BE USED WITHOUT WRITTEN PERMISSION

SCALE: mm NTS

GENERAL TOLERANCES (UNLESS SPECIFIED)

	MM	INCH
4 PLACES	±	±
3 PLACES	±	±
2 PLACES	± 0.2	±
1 PLACE	±	±
0 PLACES	±	±

ANGULAR TOL ± 3.0°

DRAFT WHERE APPLICABLE MUST REMAIN WITHIN DIMENSIONS

THIRD ANGLE PROJECTION

DRAWING: A3-SIZE

SERIES: 87898

MATERIAL NUMBER: SEE TABLE

CUSTOMER: GENERAL MARKET

SHEET NUMBER: 19 OF 21

EC NO: 679909

DRWN: AKUMAR19 2021/06/29

CHK'D: MRAMAKRISHNA 2021/10/11

APPR: MRAMAKRISHNA 2021/10/11

INITIAL REVISION:

DRWN: GGUNAGI 2016/11/09

APPR: ISHWARG 2016/12/06

DOCUMENT NUMBER: SD-87898-001

DOC TYPE: PSD

DOC PART: 000

REVISION: B24

moLEX

CUSTOM HEADER

2.54MM PITCH SINGLE ROW SINGLE WAFER SMT HEADER

PRODUCT CUSTOMER DRAWING

FORMAT: Mel-lega-master-ib-prod-A3

REVISION: E

DATE: 2020/01/14

9

8

7

6

5

4

3

2

1

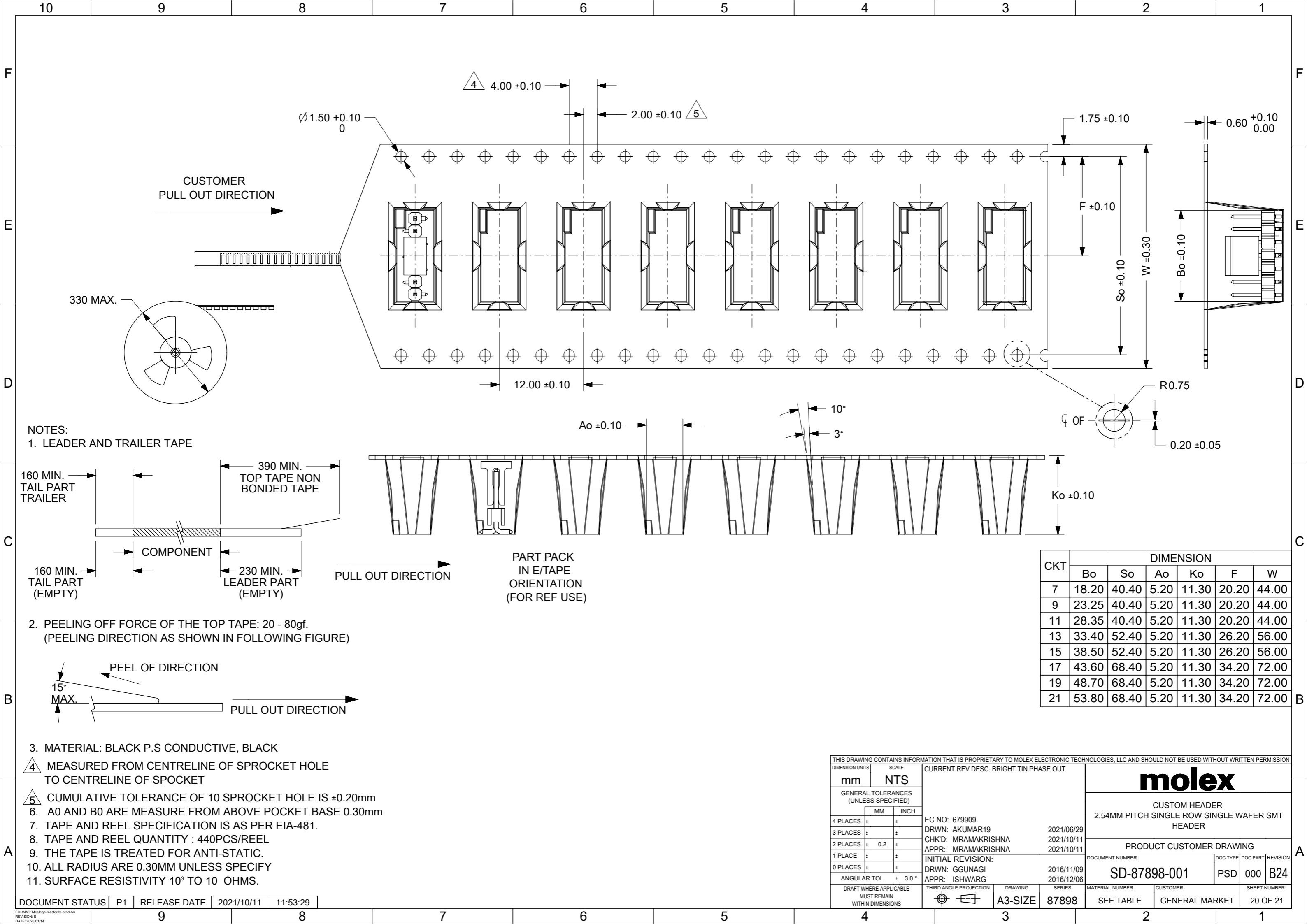

THIS DRAWING CONTAINS INFORMATION THAT IS PROPRIETARY TO MOLEX ELECTRONIC TECHNOLOGIES, LLC AND SHOULD NOT BE USED WITHOUT WRITTEN PERMISSION

DIMENSION UNITS	SCALE	CURRENT REV DESC: BRIGHT TIN PHASE OUT	
mm	NTS		
GENERAL TOLERANCES (UNLESS SPECIFIED)			
	MM	INCH	
4 PLACES	±	±	
3 PLACES	±	±	
2 PLACES	± 0.2	±	
1 PLACE	±	±	
0 PLACES	±	±	
ANGULAR TOL	± 3.0°		
DRAFT WHERE APPLICABLE MUST REMAIN WITHIN DIMENSIONS		THIRD ANGLE PROJECTION	DRAWING
			A3-SIZE
EC NO: 679909	DRWN: AKUMAR19	2021/06/29	
CHK'D: MRAMAKRISHNA	APPR: MRAMAKRISHNA	2021/10/11	
INITIAL REVISION:		DOCUMENT NUMBER	DOC TYPE DOC PART REVISION
DRWN: GGUNAGI	APPR: ISHWARG	2016/11/09	
		2016/12/06	
		SERIES	MATERIAL NUMBER
		87898	SEE TABLE
		CUSTOMER	GENERAL MARKET
		SHEET NUMBER	20 OF 21

molex
 CUSTOM HEADER
 2.54MM PITCH SINGLE ROW SINGLE WAFER SMT HEADER
 PRODUCT CUSTOMER DRAWING
 SD-87898-001
 PSD 000 B24

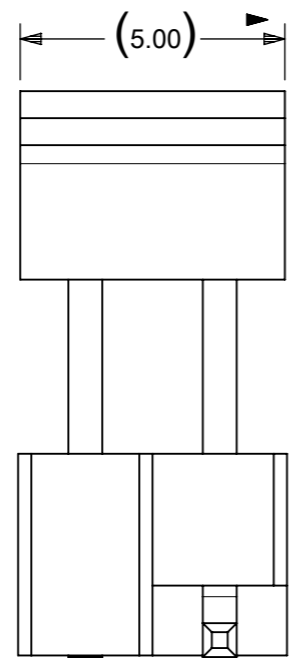
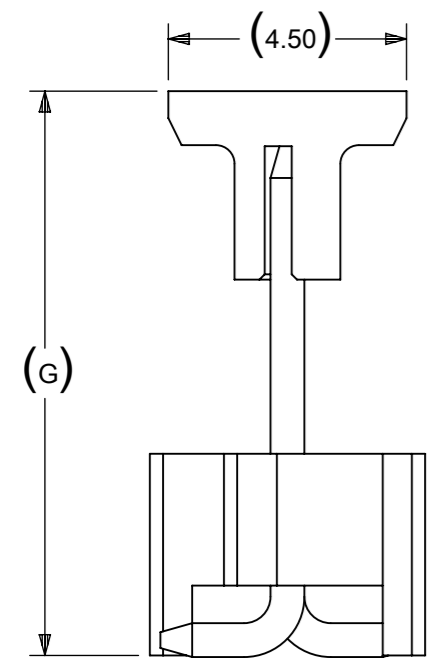
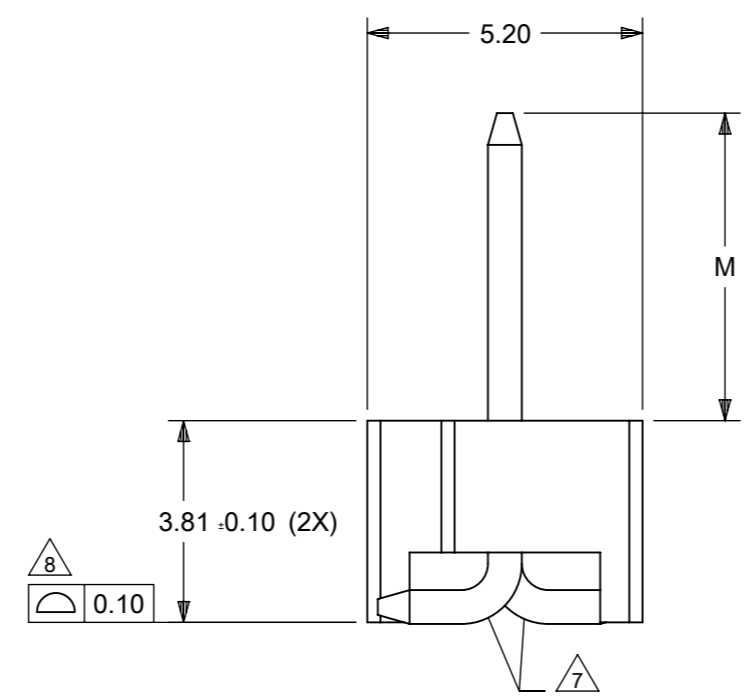
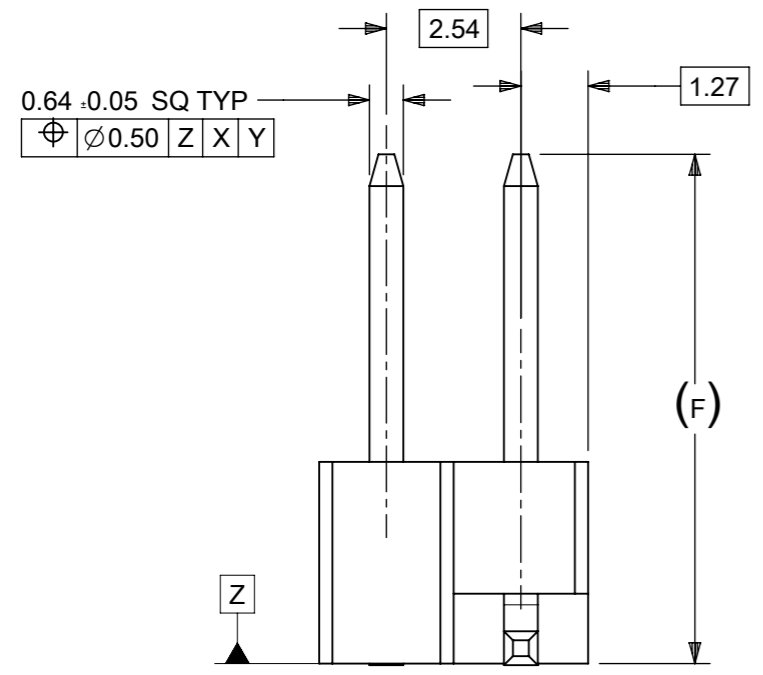
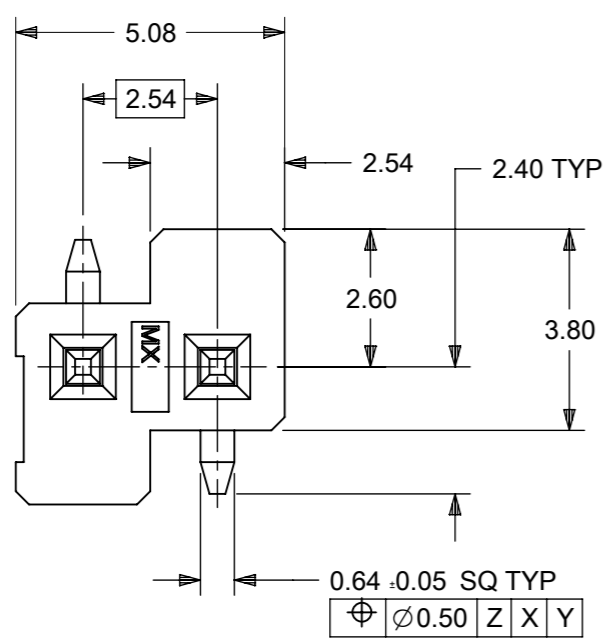

PACKAGING OPTION PART NO.						CKT SIZE	PLATING TYPE	DIMENSION		
TRAY WITHOUT CAP	TRAY WITH CAP	TUBE WITHOUT CAP	TUBE WITH CAP	TAPE & REEL WITHOUT CAP	TAPE & REEL WITH CAP			G	F	M
-----	-----	-----	-----	-----	87898-0218	2	4	10.69	9.65	5.84
-----	-----	-----	-----	-----	87898-0219	2	6	10.69	9.65	5.84
-----	-----	-----	87898-0220	-----	-----	2	6	10.64	9.60	5.84
-----	-----	-----	-----	-----	87898-0221	2	6	24.53	23.49	19.73

ONLY APPLICABLE TO 2CKT SIZE

NOTES:

- MATERIAL:
HSG: LCP, GLASS-FILLED, UL94V-0, COLOR: BLACK
CAP: NYLON, GLASS-FILLED, UL94V-0, COLOR: BLACK
PIN: 0.64MM SQ, COPPER ALLOY
- PLATING TYPE:
(1) GOLD FLASH OVER
1.25µm MIN. NICKEL OVERALL.
(2) GOLD FLASH ON CONTACT AND
2.50µm MIN. TIN ON SOLDER TAIL OVER
1.25µm MIN. NICKEL OVERALL.
(4) 0.38µm MIN. GOLD PLATE ON CONTACT AND
2.00µm MIN. TIN ON SOLDER TAIL OVER
1.25µm MIN. NICKEL OVERALL.
(5) 0.75µm MIN. GOLD PLATE ON CONTACT AND
2.00µm MIN. TIN ON SOLDER TAIL OVER
1.25µm MIN. NICKEL OVERALL.
(6) 2.50µm MIN. TIN OVERALL
1.25µm MIN. NICKEL OVERALL
- PRODUCT SPECIFICATION: PS-87920-019
- PACKAGING TYPE: SEE TABLE
- PACKAGING SPEC:
TUBE WITH CAP VERSION: PK-89990-558
TUBE W/O CAP VERSION: PK-89990-545
EMBOSS TAPE WITH CAP: PK-87898-400
- WAFER TO BE FLAT WITHIN 0.003 mm/mm
- BEND DEPRESSION IS ACCEPTED SO LONG AS IT DOES NOT AFFECT THE OVERALL COPLANARITY OF TAIL
- COPLANARITY IS TO BE MEASURED BY RESTING THE SOLDER TAIL ON A FLAT SURFACE
- CAP LOCATION IS CENTERED ALONG THE MATING ENDS AS SHOWN. TOP SURFACE OF CAP TO BE FLAT FOR THE PURPOSE OF PICK & PLACE BY VACUUM SUCTION NOZZLE
- RECOMMENDED PCB THICKNESS IS 1.60mm±0.10

THIS DRAWING CONTAINS INFORMATION THAT IS PROPRIETARY TO MOLEX ELECTRONIC TECHNOLOGIES, LLC AND SHOULD NOT BE USED WITHOUT WRITTEN PERMISSION									
DIMENSION UNITS		SCALE		CURRENT REV DESC: BRIGHT TIN PHASE OUT					
mm		NTS							
GENERAL TOLERANCES (UNLESS SPECIFIED)									
				CUSTOM HEADER 2.54MM PITCH SINGLE ROW SINGLE WAFER SMT HEADER PRODUCT CUSTOMER DRAWING					
4 PLACES ±		±							
3 PLACES ±		±							
2 PLACES ±		0.2 ±							
1 PLACE ±		±		EC NO: 679909		2021/06/29		DOCUMENT NUMBER	
0 PLACES ±		±		DRWN: AKUMAR19		2021/10/11		DOC TYPE	
ANGULAR TOL ±		3.0°		CHK'D: MRAMAKRISHNA		2021/10/11		DOC PART	
DRAFT WHERE APPLICABLE MUST REMAIN WITHIN DIMENSIONS		THIRD ANGLE PROJECTION		APPR: MRAMAKRISHNA		2021/10/11		REVISION	
				INITIAL REVISION:		2016/11/09		SD-87898-001	
				DRWN: GGUNAGI		2016/12/06		PSD	
				APPR: ISHWARG				000	
				DRAWING		SERIES		B24	
				A3-SIZE		87898		21 OF 21	
				MATERIAL NUMBER		CUSTOMER			
				SEE TABLE		GENERAL MARKET			

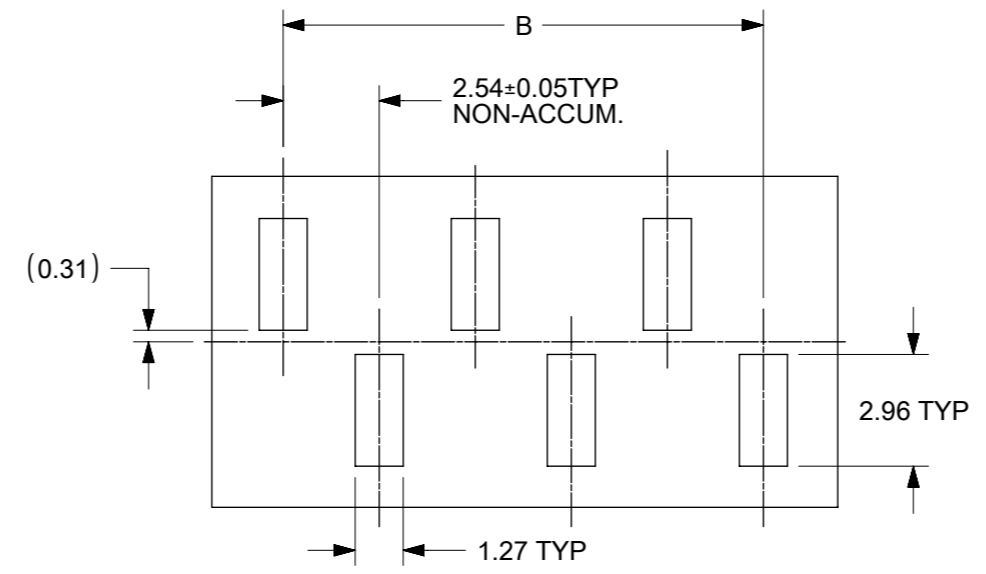
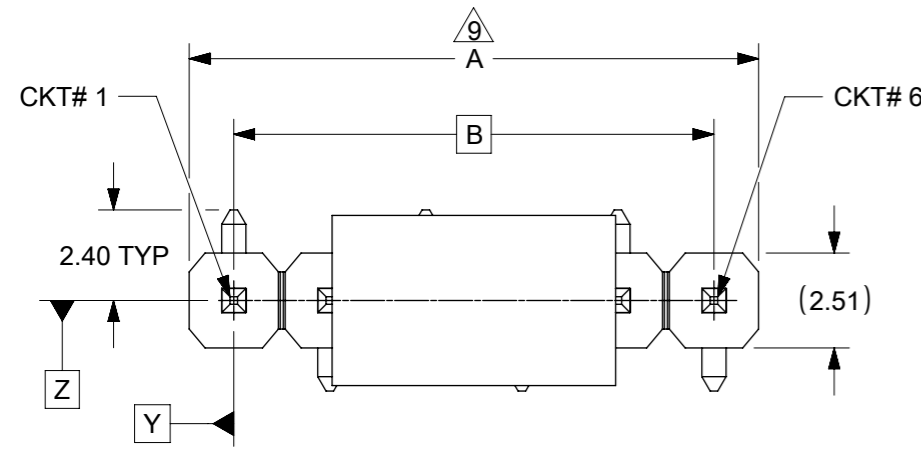

RECOMMENDED PCB LAYOUT

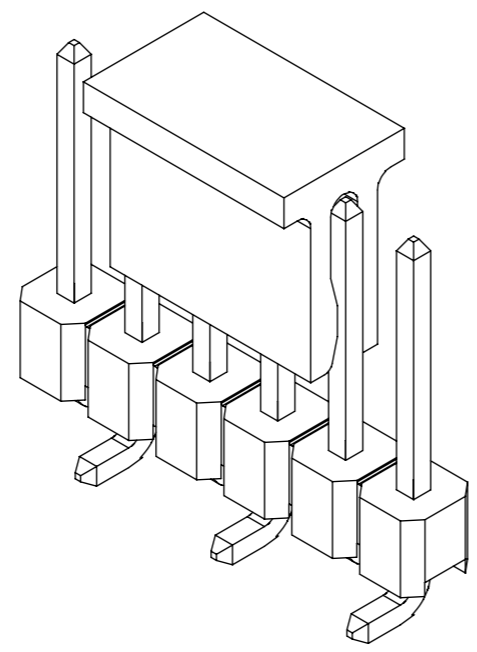
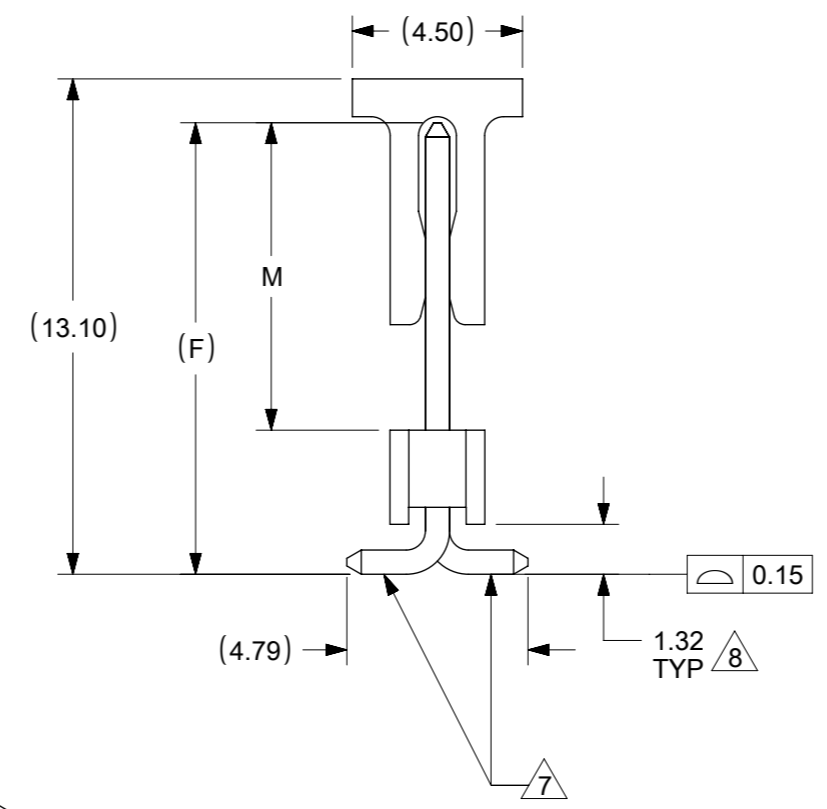
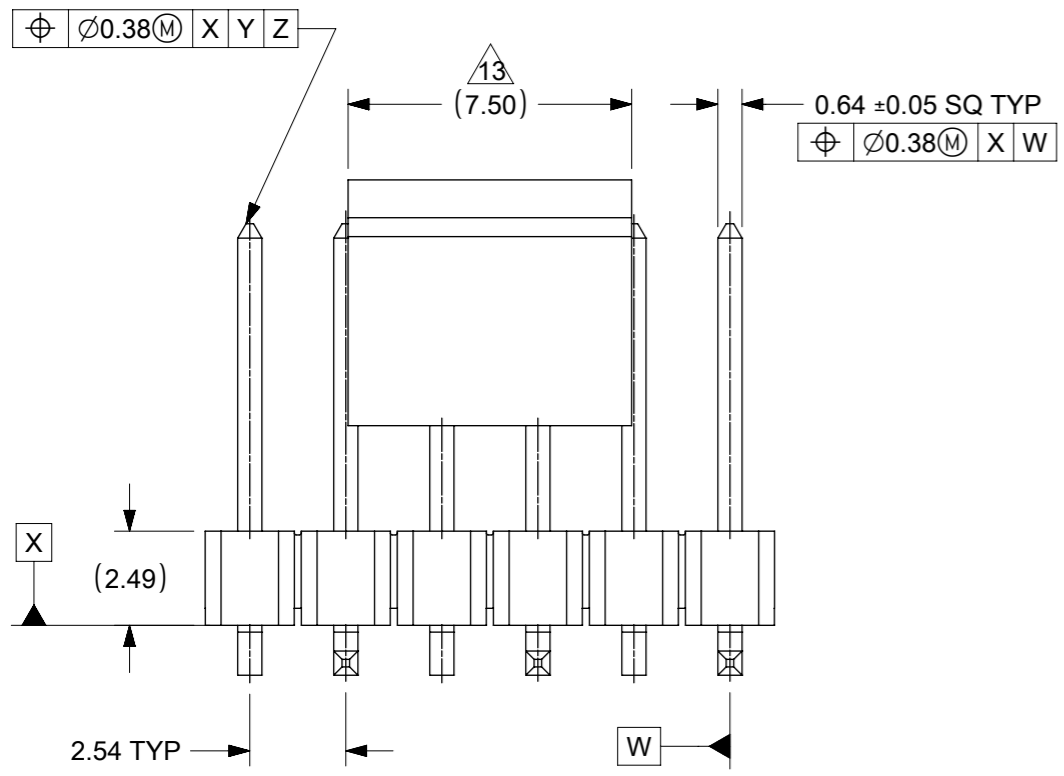

NOTES:

1. MATERIAL:
HSG: NYLON, GLASS-FILLED, UL94V-0, COLOR: BLACK
PIN: 0.64MM SQ, COPPER ALLOY
2. PLATING TYPE:
 - (1) GOLD FLASH OVER
1.25µm MIN. NICKEL OVERALL.
 - (2) GOLD FLASH ON CONTACT AND
2.50µm MIN. TIN ON SOLDER TAIL OVER
1.25µm MIN. NICKEL OVERALL.
 - (4) 0.38µm MIN. GOLD PLATE ON CONTACT AND
2.00µm MIN. TIN ON SOLDER TAIL OVER
1.25µm MIN. NICKEL OVERALL.
 - (5) 0.75µm MIN. GOLD PLATE ON CONTACT AND
2.00µm MIN. TIN ON SOLDER TAIL OVER
1.25µm MIN. NICKEL OVERALL.
 - (6) 2.50µm MIN. TIN OVERALL
1.25µm MIN. NICKEL OVERALL
3. PRODUCT SPECIFICATION: PS-87920-019
4. PACKAGING TYPE: SEE TABLE
5. PACKAGING SPEC: PK-89990-545(TUBE), PK-89990-486(T&R) & PK-87898-400 (T&R)
6. WAFER TO BE FLAT WITHIN 0.003 mm/mm
7. BEND DEPRESSION IS ACCEPTED SO LONG AS IT DOES NOT AFFECT THE OVERALL COPLANARITY OF TAIL
8. COPLANARITY IS TO BE MEASURED BY RESTING THE SOLDER TAIL ON A FLAT SURFACE
9. IRREGULAR CIRCUIT CUTOFF WITHIN BREAKAWAY SECTION IS PERMISSIBLE. CUTTING OR CHIPPING OF THE MAIN BODY IS NOT ACCEPTABLE
10. TUBE LENGTH AS PER STANDARD 560mm
11. RECOMMENDED PCB THICKNESS IS 1.60mm±0.10
12. THE ABOVE CKT 6 IS FOR ILLUSTRATION PURPOSE ONLY
13. CAP LOCATION IS CENTERED ALONG THE MATING ENDS AS SHOWN. TOP SURFACE OF CAP TO BE FLAT FOR THE PURPOSE OF PICK & PLACE BY VACUUM SUCTION NOZZLE.

THIS DRAWING CONTAINS INFORMATION THAT IS PROPRIETARY TO MOLEX ELECTRONIC TECHNOLOGIES, LLC AND SHOULD NOT BE USED WITHOUT WRITTEN PERMISSION		CURRENT REV DESC:		molex	
DIMENSION UNITS: mm		SCALE: NTS			
GENERAL TOLERANCES (UNLESS SPECIFIED)				PRODUCT CUSTOMER DRAWING	
				DOCUMENT NUMBER: SD-87898-003	
4 PLACES ± 0.2		EC NO: 698212		DOC TYPE: PSD	
3 PLACES ± 0.2		DRWN: DANUSA 2022/03/03		DOC PART: 001	
2 PLACES ± 0.2		CHK'D: DANUSA 2022/03/04		REVISION: C1	
1 PLACE ± 0.2		APPR: MRAMAKRISHNA 2022/03/04			
0 PLACES ± 0.2		INITIAL REVISION:			
ANGULAR TOL ± 3.0°		DRWN: SKLIM01 2005/10/26			
DRAFT WHERE APPLICABLE MUST REMAIN WITHIN DIMENSIONS		APPR: PTLIM 2005/11/07			
THIRD ANGLE PROJECTION		DRAWING: A3-SIZE		MATERIAL NUMBER: SEE TABLE	
		SERIES: 87898		CUSTOMER: GENERAL MARKET	
				SHEET NUMBER: 1 OF 17	

9 8 7 6 5 4 3 2 1

E

PART WITHOUT CAP
IN TUBE
ORIENTATION

PART WITH CAP
IN TUBE
ORIENTATION

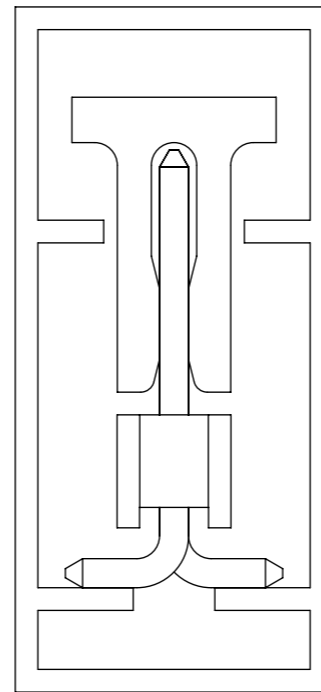
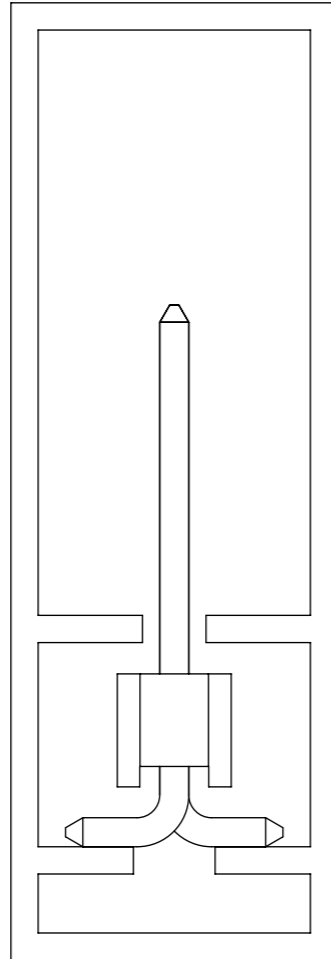

D

C

B

A

THIS DRAWING CONTAINS INFORMATION THAT IS PROPRIETARY TO MOLEX ELECTRONIC TECHNOLOGIES, LLC AND SHOULD NOT BE USED WITHOUT WRITTEN PERMISSION									
DIMENSION UNITS		SCALE		CURRENT REV DESC:				molex	
mm		NTS							
GENERAL TOLERANCES (UNLESS SPECIFIED)				EC NO: 698212				CUSTOM HEADER	
				DRWN: DANUSA 2022/03/03				2.54MM PITCH SINGLE ROW SINGLE WAFER SMT	
				CHK'D: DANUSA 2022/03/04				HEADER	
				APPR: MRAMAKRISHNA 2022/03/04				PRODUCT CUSTOMER DRAWING	
4 PLACES ±				INITIAL REVISION:				DOCUMENT NUMBER	
3 PLACES ±				DRWN: SKLIM01 2005/10/26				SD-87898-003	
2 PLACES ± 0.2				APPR: PTLIM 2005/11/07				DOC TYPE	
1 PLACE ±								PSD	
0 PLACES ±								DOC PART	
ANGULAR TOL ± 3.0°								001	
DRAFT WHERE APPLICABLE MUST REMAIN WITHIN DIMENSIONS				THIRD ANGLE PROJECTION		DRAWING		SERIES	
				A3-SIZE		87898		MATERIAL NUMBER	
				SEE TABLE		GENERAL MARKET		CUSTOMER	
								SHEET NUMBER	
								2 OF 17	

DOCUMENT STATUS	P1	RELEASE DATE	2022/03/04	09:00:56
-----------------	----	--------------	------------	----------

9 8 7 6 5 4 3 2 1

CKT	DIMENSION						QTY/REEL
	Bo	Ao	Ko	F	So	W	
3	8.02	5.20	13.60	11.50	--	24.00	320
4	10.51	5.79	15.05	14.20	28.40	32.00	250
5	13.10	5.20	13.60	11.50	---	24.00	320

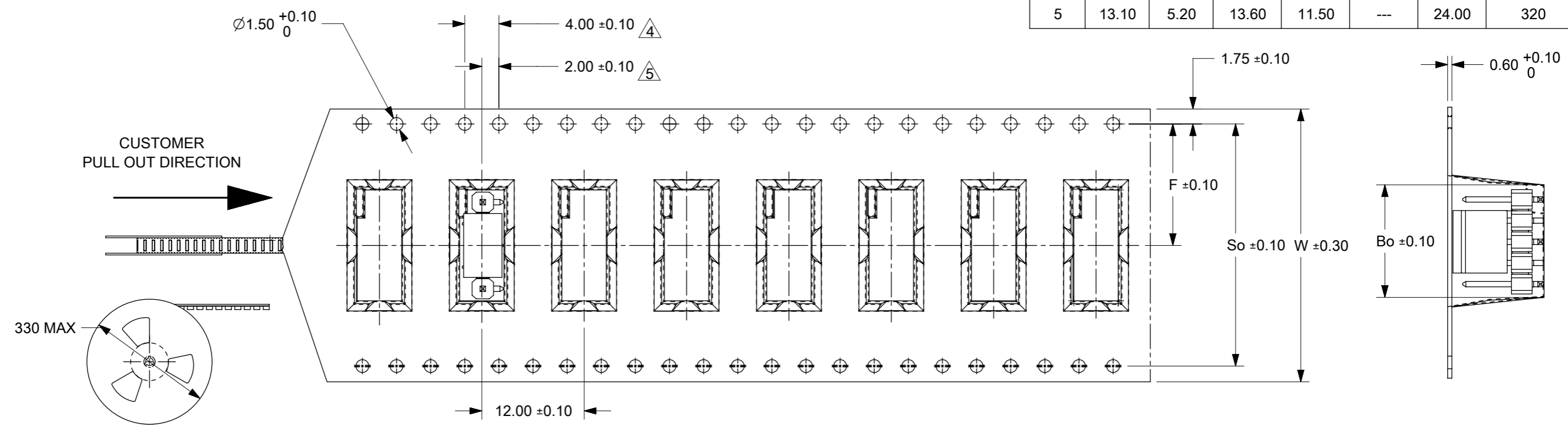

NOTES:

1. LEADER AND TRAILER TAPE

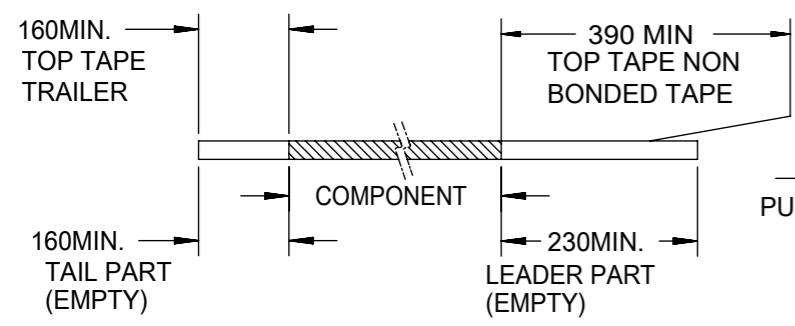

2. PEELING OFF FORCE OF THE TOP TAPE: 20 - 80gf. (PEELING DIRECTION AS SHOWN IN FOLLOWING FIGURE)

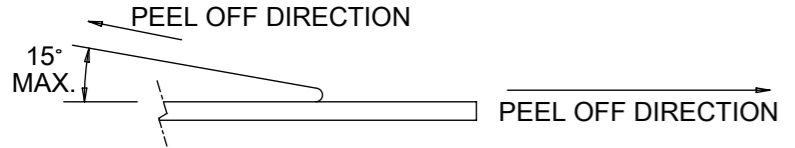

- 3. MATERIAL: BLACK P.S CONDUCTIVE, BLACK
- 4. MEASURED FROM CENTRELINE OF SPROCKET HOLE TO CENTRELINE OF POCKET
- 5. CUMULATIVE TOLERANCE OF 10 SPROCKET HOLE IS $\pm 0.20\text{mm}$
- 6. A0 AND B0 ARE MEASURE FROM ABOVE POCKET BASE 0.30mm
- 7. TAPE AND REEL SPECIFICATION IS AS PER EIA-481.
- 8. THE TAPE IS TREATED FOR ANTI-STATIC.
- 9. ALL RADIUS ARE 0.30MM UNLESS SPECIFY
- 10. SURFACE RESISTIVITY 10^3 TO 10 OHMS.

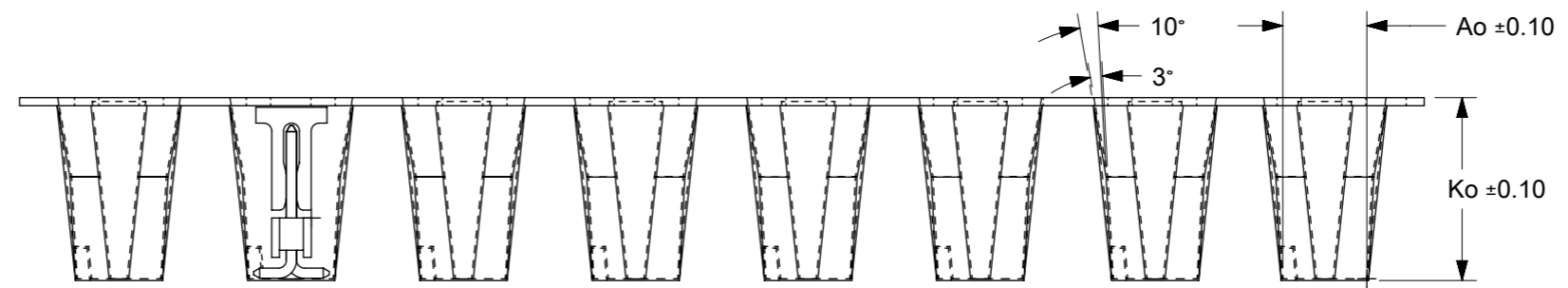

THIS DRAWING CONTAINS INFORMATION THAT IS PROPRIETARY TO MOLEX ELECTRONIC TECHNOLOGIES, LLC AND SHOULD NOT BE USED WITHOUT WRITTEN PERMISSION

DIMENSION UNITS	SCALE	CURRENT REV DESC:				
mm	NTS					
GENERAL TOLERANCES (UNLESS SPECIFIED)				CUSTOMER		
				2.54MM PITCH SINGLE ROW SINGLE WAFER SMT HEADER		
				PRODUCT CUSTOMER DRAWING		
4 PLACES	\pm	MM	INCH	EC NO: 698212	DOCUMENT NUMBER	DOC TYPE
3 PLACES	\pm			DRWN: DANUSA 2022/03/03	SD-87898-003	PSD
2 PLACES	± 0.2			CHK'D: DANUSA 2022/03/04	DOC PART	001
1 PLACE	\pm			APPR: MRAMAKRISHNA 2022/03/04	REVISION	C1
0 PLACES	\pm			INITIAL REVISION:		
ANGULAR TOL	$\pm 3.0^\circ$			DRWN: SKLIM01 2005/10/26		
				APPR: PTLIM 2005/11/07		
DRAFT WHERE APPLICABLE MUST REMAIN WITHIN DIMENSIONS		THIRD ANGLE PROJECTION	DRAWING	SERIES	MATERIAL NUMBER	CUSTOMER
			A3-SIZE	87898	SEE TABLE	GENERAL MARKET
						SHEET NUMBER
						3 OF 17

9 8 7 6 5 4 3 2 1

PACKAGING OPTION PART NO.						CKT SIZE	VOID POSITION	PLATING TYPE	DIMENSION			
TRAY WITHOUT CAP	TRAY WITH CAP	TUBE WITHOUT CAP	TUBE WITH CAP	TAPE & REEL WITHOUT CAP	TAPE & REEL WITH CAP				A	B	F	M
-----	(C) 87898-0361	-----	-----	-----	-----	3	----	1	7.62	5.08	11.94	8.13
-----	(C) 87898-0362	-----	-----	-----	-----	3	----	2	7.62	5.08	11.94	8.13
-----	(C) 87898-0364	-----	-----	-----	87898-0369	3	----	4	7.62	5.08	11.94	8.13
-----	(C) 87898-0365	-----	-----	-----	-----	3	----	5	7.62	5.08	11.94	8.13
-----	(C) 87898-0366	-----	87898-0367	-----	87898-0368	3	----	6	7.62	5.08	11.94	8.13

E

E

D

D

C

C

B

B

A

A

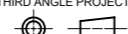
THIS DRAWING CONTAINS INFORMATION THAT IS PROPRIETARY TO MOLEX ELECTRONIC TECHNOLOGIES, LLC AND SHOULD NOT BE USED WITHOUT WRITTEN PERMISSION															
DIMENSION UNITS		SCALE		CURRENT REV DESC:											
mm		NTS													
GENERAL TOLERANCES (UNLESS SPECIFIED)				EC NO: 698212 DRWN: DANUSA 2022/03/03 CHK'D: DANUSA 2022/03/04 APPR: MRAMAKRISHNA 2022/03/04 INITIAL REVISION: DRWN: SKLIM01 2005/10/26 APPR: PTLIM 2005/11/07						CUSTOM HEADER					
										2.54MM PITCH SINGLE ROW SINGLE WAFER SMT HEADER					
										PRODUCT CUSTOMER DRAWING					
										DOCUMENT NUMBER		DOC TYPE	DOC PART	REVISION	
										SD-87898-003		PSD	001	C1	
DRAFT WHERE APPLICABLE MUST REMAIN WITHIN DIMENSIONS				THIRD ANGLE PROJECTION		DRAWING	SERIES	MATERIAL NUMBER	CUSTOMER		SHEET NUMBER				
						A3-SIZE	87898	SEE TABLE	GENERAL MARKET		4 OF 17				

DOCUMENT STATUS	P1	RELEASE DATE	2022/03/04	09:00:56
-----------------	----	--------------	------------	----------

9 8 7 6 5 4 3 2 1

FORMAT: Mel-lega-master-ib-prod-A3
REVISION: D
DATE: 2018/01/18

PACKAGING OPTION PART NO.						CKT SIZE	PEG	VOID POSITION	PLATING TYPE	DIMENSION			
TRAY WITHOUT CAP	TRAY WITH CAP	TUBE WITHOUT CAP	TUBE WITH CAP	TAPE & REEL WITHOUT CAP	TAPE & REEL WITH CAP					A	B	F	M
-----	-----	87898-0461	-----	-----	-----	4	---	----	1	10.16	7.62	11.94	8.13
-----	-----	87898-0462	-----	-----	-----	4	---	----	2	10.16	7.62	11.94	8.13
-----	-----	87898-0464	-----	-----	-----	4	---	----	4	10.16	7.62	11.94	8.13
-----	-----	87898-0465	-----	-----	-----	4	---	----	5	10.16	7.62	11.94	8.13
-----	-----	87898-0466	-----	-----	87898-0467	4	---	----	6	10.16	7.62	11.94	8.13
-----	-----	-----	-----	-----	87898-0468	4	Y	----	6	10.16	7.62	11.94	8.13
-----	-----	-----	-----	87898-0489	-----	4	Y	----	5	10.16	7.62	16.74	12.93
-----	-----	87898-0561	-----	-----	-----	5	---	----	1	12.70	10.16	11.94	8.13
-----	-----	87898-0562	-----	-----	-----	5	---	----	2	12.70	10.16	11.94	8.13
-----	-----	87898-0564	-----	-----	-----	5	---	----	4	12.70	10.16	11.94	8.13
-----	-----	87898-0565	-----	-----	-----	5	---	----	5	12.70	10.16	11.94	8.13
-----	-----	87898-0566	87898-0567	-----	87898-0568	5	---	----	6	12.70	10.16	11.94	8.13
-----	-----	87898-0661	-----	-----	-----	6	---	----	1	15.24	12.70	11.94	8.13
-----	-----	87898-0662	-----	-----	-----	6	---	----	2	15.24	12.70	11.94	8.13
-----	-----	87898-0664	-----	-----	-----	6	---	----	4	15.24	12.70	11.94	8.13
-----	-----	87898-0665	-----	-----	(C) -----	6	---	----	5	15.24	12.70	11.94	8.13
-----	-----	87898-0666	-----	-----	87898-0605	6	---	----	6	15.24	12.70	11.94	8.13

4 CKT WITH PEG FOR ILLUSTRATION ONLY

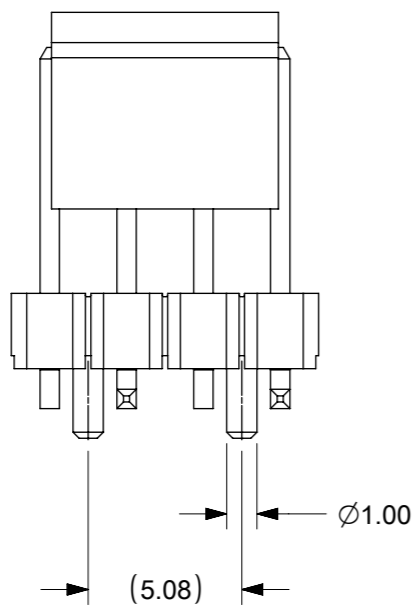

THIS DRAWING CONTAINS INFORMATION THAT IS PROPRIETARY TO MOLEX ELECTRONIC TECHNOLOGIES, LLC AND SHOULD NOT BE USED WITHOUT WRITTEN PERMISSION											
DIMENSION UNITS		SCALE		CURRENT REV DESC:							
mm		NTS									
GENERAL TOLERANCES (UNLESS SPECIFIED)				EC NO: 698212		DRWN: DANUSA		2022/03/03		CUSTOM HEADER 2.54MM PITCH SINGLE ROW SINGLE WAFER SMT HEADER	
				CHK'D: DANUSA		2022/03/04					
4 PLACES ±				APPR: MRAMAKRISHNA		2022/03/04		PRODUCT CUSTOMER DRAWING			
3 PLACES ±				INITIAL REVISION:		DRWN: SKLIM01		2005/10/26		DOCUMENT NUMBER	
2 PLACES ± 0.2				APPR: PTLIM		2005/11/07		SD-87898-003		DOC TYPE DOC PART REVISION	
1 PLACE ±				THIRD ANGLE PROJECTION		DRAWING		SERIES		MATERIAL NUMBER	
0 PLACES ±				DRAFT WHERE APPLICABLE MUST REMAIN WITHIN DIMENSIONS		A3-SIZE		87898		CUSTOMER	
ANGULAR TOL ± 3.0°								SEE TABLE		GENERAL MARKET	
SHEET NUMBER				5 OF 17							

PACKAGING OPTION PART NO.						CKT SIZE	VOID POSITION	PLATING TYPE	DIMENSION			
TRAY WITHOUT CAP	TRAY WITH CAP	TUBE WITHOUT CAP	TUBE WITH CAP	TAPE & REEL WITHOUT CAP	TAPE & REEL WITH CAP				A	B	F	M
-----	-----	87898-0761	-----	-----	-----	7	----	1	17.78	15.24	11.94	8.13
-----	-----	87898-0762	-----	-----	-----	7	----	2	17.78	15.24	11.94	8.13
-----	-----	87898-0764	-----	-----	-----	7	----	4	17.78	15.24	11.94	8.13
-----	-----	87898-0765	-----	-----	-----	7	----	5	17.78	15.24	11.94	8.13
-----	-----	87898-0766	-----	-----	-----	7	----	6	17.78	15.24	11.94	8.13
-----	-----	87898-0861	-----	-----	-----	8	----	1	20.32	17.78	11.94	8.13
-----	-----	87898-0862	-----	-----	-----	8	----	2	20.32	17.78	11.94	8.13
-----	-----	87898-0864	-----	-----	-----	8	----	4	20.32	17.78	11.94	8.13
-----	-----	87898-0865	-----	-----	-----	8	----	5	20.32	17.78	11.94	8.13
-----	-----	87898-0866	-----	-----	-----	8	----	6	20.32	17.78	11.94	8.13
-----	-----	87898-0961	-----	-----	-----	9	----	1	22.86	20.32	11.94	8.13
-----	-----	87898-0962	-----	-----	-----	9	----	2	22.86	20.32	11.94	8.13
-----	-----	87898-0964	-----	-----	-----	9	----	4	22.86	20.32	11.94	8.13
-----	-----	87898-0965	-----	-----	-----	9	----	5	22.86	20.32	11.94	8.13
-----	-----	87898-0966	-----	-----	-----	9	----	6	22.86	20.32	11.94	8.13

THIS DRAWING CONTAINS INFORMATION THAT IS PROPRIETARY TO MOLEX ELECTRONIC TECHNOLOGIES, LLC AND SHOULD NOT BE USED WITHOUT WRITTEN PERMISSION

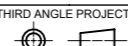
DIMENSION UNITS		SCALE		CURRENT REV DESC:								
mm		NTS										
GENERAL TOLERANCES (UNLESS SPECIFIED)				EC NO: 698212 DRWN: DANUSA 2022/03/03 CHK'D: DANUSA 2022/03/04 APPR: MRAMAKRISHNA 2022/03/04				CUSTOM HEADER 2.54MM PITCH SINGLE ROW SINGLE WAFER SMT HEADER				
		MM	INCH									
4 PLACES	±		±	INITIAL REVISION: DRWN: SKLIM01 2005/10/26 APPR: PTLIM 2005/11/07				PRODUCT CUSTOMER DRAWING DOCUMENT NUMBER: SD-87898-003 DOC TYPE: PSD DOC PART: 001 REVISION: C1				
3 PLACES	±		±									
2 PLACES	±	0.2	±	DRAFT WHERE APPLICABLE MUST REMAIN WITHIN DIMENSIONS				THIRD ANGLE PROJECTION 				
1 PLACE	±		±									
0 PLACES	±		±	DRAWING		SERIES		MATERIAL NUMBER		CUSTOMER		SHEET NUMBER
ANGULAR TOL ± 3.0°				A3-SIZE		87898		SEE TABLE		GENERAL MARKET		6 OF 17

PACKAGING OPTION PART NO.						CKT SIZE	VOID POSITION	PLATING TYPE	DIMENSION			
TRAY WITHOUT CAP	TRAY WITH CAP	TUBE WITHOUT CAP	TUBE WITH CAP	TAPE & REEL WITHOUT CAP	TAPE & REEL WITH CAP				A	B	F	M
-----	-----	87898-1061	-----	-----	-----	10	----	1	25.40	22.86	11.94	8.13
-----	-----	87898-1062	-----	-----	-----	10	----	2	25.40	22.86	11.94	8.13
-----	-----	87898-1064	-----	-----	-----	10	----	4	25.40	22.86	11.94	8.13
-----	-----	87898-1065	-----	-----	-----	10	----	5	25.40	22.86	11.94	8.13
-----	-----	87898-1066	-----	-----	-----	10	----	6	25.40	22.86	11.94	8.13
-----	-----	87898-1161	-----	-----	-----	11	----	1	27.94	25.40	11.94	8.13
-----	-----	87898-1162	-----	-----	-----	11	----	2	27.94	25.40	11.94	8.13
-----	-----	87898-1164	-----	-----	-----	11	----	4	27.94	25.40	11.94	8.13
-----	-----	87898-1165	-----	-----	-----	11	----	5	27.94	25.40	11.94	8.13
-----	-----	87898-1166	-----	-----	-----	11	----	6	27.94	25.40	11.94	8.13
-----	-----	87898-1261	-----	-----	-----	12	----	1	30.48	27.94	11.94	8.13
-----	-----	87898-1262	-----	-----	-----	12	----	2	30.48	27.94	11.94	8.13
-----	-----	87898-1264	-----	-----	-----	12	----	4	30.48	27.94	11.94	8.13
-----	-----	87898-1265	-----	-----	-----	12	----	5	30.48	27.94	11.94	8.13
-----	-----	87898-1266	-----	-----	-----	12	----	6	30.48	27.94	11.94	8.13

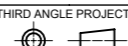
THIS DRAWING CONTAINS INFORMATION THAT IS PROPRIETARY TO MOLEX ELECTRONIC TECHNOLOGIES, LLC AND SHOULD NOT BE USED WITHOUT WRITTEN PERMISSION											
DIMENSION UNITS		SCALE		CURRENT REV DESC:							
mm		NTS		EC NO: 698212							
GENERAL TOLERANCES (UNLESS SPECIFIED)				DRWN: DANUSA		2022/03/03		CUSTOM HEADER			
				CHK'D: DANUSA		2022/03/04		2.54MM PITCH SINGLE ROW SINGLE WAFER SMT HEADER			
4 PLACES ±		±		APPR: MRAMAKRISHNA		2022/03/04		PRODUCT CUSTOMER DRAWING			
3 PLACES ±		±		INITIAL REVISION:				DOCUMENT NUMBER		DOC TYPE DOC PART REVISION	
2 PLACES ±		0.2 ±		DRWN: SKLIM01		2005/10/26		SD-87898-003		PSD 001 C1	
1 PLACE ±		±		APPR: PTLIM		2005/11/07		MATERIAL NUMBER		CUSTOMER	
0 PLACES ±		±		THIRD ANGLE PROJECTION		DRAWING		SERIES		SHEET NUMBER	
ANGULAR TOL ±		3.0°				A3-SIZE		87898		7 OF 17	
DRAFT WHERE APPLICABLE MUST REMAIN WITHIN DIMENSIONS				DRAWING		SERIES		MATERIAL NUMBER		CUSTOMER	
								SEE TABLE		GENERAL MARKET	

PACKAGING OPTION PART NO.						CKT SIZE	VOID POSITION	PLATING TYPE	DIMENSION			
TRAY WITHOUT CAP	TRAY WITH CAP	TUBE WITHOUT CAP	TUBE WITH CAP	TAPE & REEL WITHOUT CAP	TAPE & REEL WITH CAP				A	B	F	M
-----	-----	87898-1361	-----	-----	-----	13	----	1	33.02	30.48	11.94	8.13
-----	-----	87898-1362	-----	-----	-----	13	----	2	33.02	30.48	11.94	8.13
-----	-----	87898-1364	-----	-----	-----	13	----	4	33.02	30.48	11.94	8.13
-----	-----	87898-1365	-----	-----	-----	13	----	5	33.02	30.48	11.94	8.13
-----	-----	87898-1366	-----	-----	-----	13	----	6	33.02	30.48	11.94	8.13
-----	-----	87898-1461	-----	-----	-----	14	----	1	35.56	33.02	11.94	8.13
-----	-----	87898-1462	-----	-----	-----	14	----	2	35.56	33.02	11.94	8.13
-----	-----	87898-1464	-----	-----	-----	14	----	4	35.56	33.02	11.94	8.13
-----	-----	87898-1465	-----	-----	-----	14	----	5	35.56	33.02	11.94	8.13
-----	-----	87898-1466	-----	-----	-----	14	----	6	35.56	33.02	11.94	8.13
-----	-----	87898-1561	-----	-----	-----	15	----	1	38.10	35.56	11.94	8.13
-----	-----	87898-1562	-----	-----	-----	15	----	2	38.10	35.56	11.94	8.13
-----	-----	87898-1564	-----	-----	-----	15	----	4	38.10	35.56	11.94	8.13
-----	-----	87898-1565	-----	-----	-----	15	----	5	38.10	35.56	11.94	8.13
-----	-----	87898-1566	-----	-----	-----	15	----	6	38.10	35.56	11.94	8.13

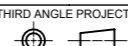
THIS DRAWING CONTAINS INFORMATION THAT IS PROPRIETARY TO MOLEX ELECTRONIC TECHNOLOGIES, LLC AND SHOULD NOT BE USED WITHOUT WRITTEN PERMISSION													
DIMENSION UNITS		SCALE		CURRENT REV DESC:									
mm		NTS											
GENERAL TOLERANCES (UNLESS SPECIFIED)				EC NO: 698212 DRWN: DANUSA 2022/03/03 CHK'D: DANUSA 2022/03/04 APPR: MRAMAKRISHNA 2022/03/04						CUSTOM HEADER 2.54MM PITCH SINGLE ROW SINGLE WAFER SMT HEADER			
		MM	INCH										
4 PLACES	±		±	INITIAL REVISION: DRWN: SKLIM01 2005/10/26 APPR: PTLIM 2005/11/07						PRODUCT CUSTOMER DRAWING DOCUMENT NUMBER: SD-87898-003 DOC TYPE: PSD DOC PART: 001 REVISION: C1			
3 PLACES	±		±										
2 PLACES	±	0.2	±	DRAFT WHERE APPLICABLE MUST REMAIN WITHIN DIMENSIONS						THIRD ANGLE PROJECTION 			
1 PLACE	±		±										
0 PLACES	±		±	DRAWING		SERIES		MATERIAL NUMBER		CUSTOMER		SHEET NUMBER	
ANGULAR TOL ± 3.0°				A3-SIZE		87898		SEE TABLE		GENERAL MARKET		8 OF 17	

PACKAGING OPTION PART NO.						CKT SIZE	VOID POSITION	PLATING TYPE	DIMENSION			
TRAY WITHOUT CAP	TRAY WITH CAP	TUBE WITHOUT CAP	TUBE WITH CAP	TAPE & REEL WITHOUT CAP	TAPE & REEL WITH CAP				A	B	F	M
-----	-----	87898-1661	-----	-----	-----	16	----	1	40.64	38.10	11.94	8.13
-----	-----	87898-1662	-----	-----	-----	16	----	2	40.64	38.10	11.94	8.13
-----	-----	87898-1664	-----	-----	-----	16	----	4	40.64	38.10	11.94	8.13
-----	-----	87898-1665	-----	-----	-----	16	----	5	40.64	38.10	11.94	8.13
-----	-----	87898-1666	-----	-----	-----	16	----	6	40.64	38.10	11.94	8.13
-----	-----	87898-1761	-----	-----	-----	17	----	1	43.18	40.64	11.94	8.13
-----	-----	87898-1762	-----	-----	-----	17	----	2	43.18	40.64	11.94	8.13
-----	-----	87898-1764	-----	-----	-----	17	----	4	43.18	40.64	11.94	8.13
-----	-----	87898-1765	-----	-----	-----	17	----	5	43.18	40.64	11.94	8.13
-----	-----	87898-1766	-----	-----	-----	17	----	6	43.18	40.64	11.94	8.13
-----	-----	87898-1861	-----	-----	-----	18	----	1	45.72	43.18	11.94	8.13
-----	-----	87898-1862	-----	-----	-----	18	----	2	45.72	43.18	11.94	8.13
-----	-----	87898-1864	-----	-----	-----	18	----	4	45.72	43.18	11.94	8.13
-----	-----	87898-1865	-----	-----	-----	18	----	5	45.72	43.18	11.94	8.13
-----	-----	87898-1866	-----	-----	-----	18	----	6	45.72	43.18	11.94	8.13

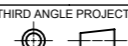
THIS DRAWING CONTAINS INFORMATION THAT IS PROPRIETARY TO MOLEX ELECTRONIC TECHNOLOGIES, LLC AND SHOULD NOT BE USED WITHOUT WRITTEN PERMISSION											
DIMENSION UNITS		SCALE		CURRENT REV DESC:							
mm		NTS		EC NO: 698212							
GENERAL TOLERANCES (UNLESS SPECIFIED)				DRWN: DANUSA		2022/03/03		CUSTOM HEADER			
				CHK'D: DANUSA		2022/03/04		2.54MM PITCH SINGLE ROW SINGLE WAFER SMT HEADER			
4 PLACES		±		APPR: MRAMAKRISHNA		2022/03/04		PRODUCT CUSTOMER DRAWING			
3 PLACES		±		INITIAL REVISION:				DOCUMENT NUMBER		DOC TYPE DOC PART REVISION	
2 PLACES		± 0.2		DRWN: SKLIM01		2005/10/26		SD-87898-003		PSD 001 C1	
1 PLACE		±		APPR: PTLIM		2005/11/07		MATERIAL NUMBER		CUSTOMER	
0 PLACES		±		DRAFT WHERE APPLICABLE MUST REMAIN WITHIN DIMENSIONS		THIRD ANGLE PROJECTION		DRAWING		SERIES	
ANGULAR TOL		± 3.0°				A3-SIZE		87898		SEE TABLE	
DRAFT WHERE APPLICABLE MUST REMAIN WITHIN DIMENSIONS								GENERAL MARKET		SHEET NUMBER	
										9 OF 17	

PACKAGING OPTION PART NO.						CKT SIZE	VOID POSITION	PLATING TYPE	DIMENSION			
TRAY WITHOUT CAP	TRAY WITH CAP	TUBE WITHOUT CAP	TUBE WITH CAP	TAPE & REEL WITHOUT CAP	TAPE & REEL WITH CAP				A	B	F	M
-----	-----	87898-1961	-----	-----	-----	19	----	1	48.26	45.72	11.94	8.13
-----	-----	87898-1962	-----	-----	-----	19	----	2	48.26	45.72	11.94	8.13
-----	-----	87898-1964	-----	-----	-----	19	----	4	48.26	45.72	11.94	8.13
-----	-----	87898-1965	-----	-----	-----	19	----	5	48.26	45.72	11.94	8.13
-----	-----	87898-1966	-----	-----	-----	19	----	6	48.26	45.72	11.94	8.13
-----	-----	87898-2061	-----	-----	-----	20	----	1	50.80	48.26	11.94	8.13
-----	-----	87898-2062	-----	-----	-----	20	----	2	50.80	48.26	11.94	8.13
-----	-----	87898-2064	-----	-----	-----	20	----	4	50.80	48.26	11.94	8.13
-----	-----	87898-2065	-----	-----	-----	20	----	5	50.80	48.26	11.94	8.13
-----	-----	87898-2066	-----	-----	-----	20	----	6	50.80	48.26	11.94	8.13
-----	-----	87898-2161	-----	-----	-----	21	----	1	53.34	50.80	11.94	8.13
-----	-----	87898-2162	-----	-----	-----	21	----	2	53.34	50.80	11.94	8.13
-----	-----	87898-2164	-----	-----	-----	21	----	4	53.34	50.80	11.94	8.13
-----	-----	87898-2165	-----	-----	-----	21	----	5	53.34	50.80	11.94	8.13
-----	-----	87898-2166	-----	-----	-----	21	----	6	53.34	50.80	11.94	8.13

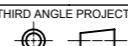
THIS DRAWING CONTAINS INFORMATION THAT IS PROPRIETARY TO MOLEX ELECTRONIC TECHNOLOGIES, LLC AND SHOULD NOT BE USED WITHOUT WRITTEN PERMISSION													
DIMENSION UNITS		SCALE		CURRENT REV DESC:									
mm		NTS											
GENERAL TOLERANCES (UNLESS SPECIFIED)				EC NO: 698212 DRWN: DANUSA 2022/03/03 CHK'D: DANUSA 2022/03/04 APPR: MRAMAKRISHNA 2022/03/04						CUSTOM HEADER 2.54MM PITCH SINGLE ROW SINGLE WAFER SMT HEADER			
4 PLACES		±	±	INITIAL REVISION: DRWN: SKLIM01 2005/10/26 APPR: PTLIM 2005/11/07						PRODUCT CUSTOMER DRAWING DOCUMENT NUMBER: SD-87898-003 DOC TYPE: PSD DOC PART: 001 REVISION: C1			
3 PLACES		±	±										
2 PLACES		± 0.2	±	DRAFT WHERE APPLICABLE MUST REMAIN WITHIN DIMENSIONS						THIRD ANGLE PROJECTION 			
1 PLACE		±	±										
0 PLACES		±	±	DRAWING		SERIES		MATERIAL NUMBER		CUSTOMER		SHEET NUMBER	
ANGULAR TOL		± 3.0°		A3-SIZE		87898		SEE TABLE		GENERAL MARKET		10 OF 17	

PACKAGING OPTION PART NO.						CKT SIZE	VOID POSITION	PLATING TYPE	DIMENSION			
TRAY WITHOUT CAP	TRAY WITH CAP	TUBE WITHOUT CAP	TUBE WITH CAP	TAPE & REEL WITHOUT CAP	TAPE & REEL WITH CAP				A	B	F	M
-----	-----	87898-2261	-----	-----	-----	22	----	1	55.88	53.34	11.94	8.13
-----	-----	87898-2262	-----	-----	-----	22	----	2	55.88	53.34	11.94	8.13
-----	-----	87898-2264	-----	-----	-----	22	----	4	55.88	53.34	11.94	8.13
-----	-----	87898-2265	-----	-----	-----	22	----	5	55.88	53.34	11.94	8.13
-----	-----	87898-2266	-----	-----	-----	22	----	6	55.88	53.34	11.94	8.13
-----	-----	87898-2361	-----	-----	-----	23	----	1	58.42	55.88	11.94	8.13
-----	-----	87898-2362	-----	-----	-----	23	----	2	58.42	55.88	11.94	8.13
-----	-----	87898-2364	-----	-----	-----	23	----	4	58.42	55.88	11.94	8.13
-----	-----	87898-2365	-----	-----	-----	23	----	5	58.42	55.88	11.94	8.13
-----	-----	87898-2366	-----	-----	-----	23	----	6	58.42	55.88	11.94	8.13
-----	-----	87898-2461	-----	-----	-----	24	----	1	60.96	58.42	11.94	8.13
-----	-----	87898-2462	-----	-----	-----	24	----	2	60.96	58.42	11.94	8.13
-----	-----	87898-2464	-----	-----	-----	24	----	4	60.96	58.42	11.94	8.13
-----	-----	87898-2465	-----	-----	-----	24	----	5	60.96	58.42	11.94	8.13
-----	-----	87898-2466	-----	-----	-----	24	----	6	60.96	58.42	11.94	8.13

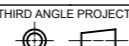
THIS DRAWING CONTAINS INFORMATION THAT IS PROPRIETARY TO MOLEX ELECTRONIC TECHNOLOGIES, LLC AND SHOULD NOT BE USED WITHOUT WRITTEN PERMISSION												
DIMENSION UNITS		SCALE		CURRENT REV DESC:								
mm		NTS		EC NO: 698212								
GENERAL TOLERANCES (UNLESS SPECIFIED)				DRWN: DANUSA 2022/03/03				CUSTOM HEADER 2.54MM PITCH SINGLE ROW SINGLE WAFER SMT HEADER				
				CHK'D: DANUSA 2022/03/04								
				APPR: MRAMAKRISHNA 2022/03/04				PRODUCT CUSTOMER DRAWING				
4 PLACES ±				INITIAL REVISION:				DOCUMENT NUMBER		DOC TYPE	DOC PART	REVISION
3 PLACES ±				DRWN: SKLIM01 2005/10/26				SD-87898-003		PSD	001	C1
2 PLACES ± 0.2				APPR: PTLIM 2005/11/07				MATERIAL NUMBER		CUSTOMER		SHEET NUMBER
1 PLACE ±				DRAFT WHERE APPLICABLE MUST REMAIN WITHIN DIMENSIONS				SEE TABLE		GENERAL MARKET		11 OF 17
0 PLACES ±				THIRD ANGLE PROJECTION				DRAWING		SERIES		
ANGULAR TOL ± 3.0°								A3-SIZE		87898		

PACKAGING OPTION PART NO.						CKT SIZE	VOID POSITION	PLATING TYPE	DIMENSION			
TRAY WITHOUT CAP	TRAY WITH CAP	TUBE WITHOUT CAP	TUBE WITH CAP	TAPE & REEL WITHOUT CAP	TAPE & REEL WITH CAP				A	B	F	M
-----	-----	87898-2561	-----	-----	-----	25	----	1	63.50	60.96	11.94	8.13
-----	-----	87898-2562	-----	-----	-----	25	----	2	63.50	60.96	11.94	8.13
-----	-----	87898-2564	-----	-----	-----	25	----	4	63.50	60.96	11.94	8.13
-----	-----	87898-2565	-----	-----	-----	25	----	5	63.50	60.96	11.94	8.13
-----	-----	87898-2566	-----	-----	-----	25	----	6	63.50	60.96	11.94	8.13
-----	-----	87898-2661	-----	-----	-----	26	----	1	66.04	63.50	11.94	8.13
-----	-----	87898-2662	-----	-----	-----	26	----	2	66.04	63.50	11.94	8.13
-----	-----	87898-2664	-----	-----	-----	26	----	4	66.04	63.50	11.94	8.13
-----	-----	87898-2665	-----	-----	-----	26	----	5	66.04	63.50	11.94	8.13
-----	-----	87898-2666	-----	-----	-----	26	----	6	66.04	63.50	11.94	8.13
-----	-----	87898-2761	-----	-----	-----	27	----	1	68.58	66.04	11.94	8.13
-----	-----	87898-2762	-----	-----	-----	27	----	2	68.58	66.04	11.94	8.13
-----	-----	87898-2764	-----	-----	-----	27	----	4	68.58	66.04	11.94	8.13
-----	-----	87898-2765	-----	-----	-----	27	----	5	68.58	66.04	11.94	8.13
-----	-----	87898-2766	-----	-----	-----	27	----	6	68.58	66.04	11.94	8.13

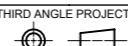
THIS DRAWING CONTAINS INFORMATION THAT IS PROPRIETARY TO MOLEX ELECTRONIC TECHNOLOGIES, LLC AND SHOULD NOT BE USED WITHOUT WRITTEN PERMISSION												
DIMENSION UNITS		SCALE		CURRENT REV DESC:								
mm		NTS										
GENERAL TOLERANCES (UNLESS SPECIFIED)				EC NO: 698212 DRWN: DANUSA 2022/03/03 CHK'D: DANUSA 2022/03/04 APPR: MRAMAKRISHNA 2022/03/04				CUSTOM HEADER 2.54MM PITCH SINGLE ROW SINGLE WAFER SMT HEADER				
		MM	INCH									
4 PLACES	±		±	INITIAL REVISION: DRWN: SKLIM01 2005/10/26 APPR: PTLIM 2005/11/07				DOCUMENT NUMBER		DOC TYPE	DOC PART	REVISION
3 PLACES	±		±					SD-87898-003		PSD	001	C1
2 PLACES	±	0.2	±	DRAFT WHERE APPLICABLE MUST REMAIN WITHIN DIMENSIONS				MATERIAL NUMBER		CUSTOMER		SHEET NUMBER
1 PLACE	±		±					SEE TABLE		GENERAL MARKET		12 OF 17
0 PLACES	±		±	THIRD ANGLE PROJECTION		DRAWING	SERIES	CUSTOMER		SHEET NUMBER		
ANGULAR TOL ± 3.0°				A3-SIZE	87898	SEE TABLE		GENERAL MARKET		12 OF 17		

PACKAGING OPTION PART NO.						CKT SIZE	VOID POSITION	PLATING TYPE	DIMENSION			
TRAY WITHOUT CAP	TRAY WITH CAP	TUBE WITHOUT CAP	TUBE WITH CAP	TAPE & REEL WITHOUT CAP	TAPE & REEL WITH CAP				A	B	F	M
-----	-----	87898-2861	-----	-----	-----	28	----	1	71.12	68.58	11.94	8.13
-----	-----	87898-2862	-----	-----	-----	28	----	2	71.12	68.58	11.94	8.13
-----	-----	87898-2864	-----	-----	-----	28	----	4	71.12	68.58	11.94	8.13
-----	-----	87898-2865	-----	-----	-----	28	----	5	71.12	68.58	11.94	8.13
-----	-----	87898-2866	-----	-----	-----	28	----	6	71.12	68.58	11.94	8.13
-----	-----	87898-2961	-----	-----	-----	29	----	1	73.66	71.12	11.94	8.13
-----	-----	87898-2962	-----	-----	-----	29	----	2	73.66	71.12	11.94	8.13
-----	-----	87898-2964	-----	-----	-----	29	----	4	73.66	71.12	11.94	8.13
-----	-----	87898-2965	-----	-----	-----	29	----	5	73.66	71.12	11.94	8.13
-----	-----	87898-2966	-----	-----	-----	29	----	6	73.66	71.12	11.94	8.13
-----	-----	87898-3061	-----	-----	-----	30	----	1	76.20	73.66	11.94	8.13
-----	-----	87898-3062	-----	-----	-----	30	----	2	76.20	73.66	11.94	8.13
-----	-----	87898-3064	-----	-----	-----	30	----	4	76.20	73.66	11.94	8.13
-----	-----	87898-3065	-----	-----	-----	30	----	5	76.20	73.66	11.94	8.13
-----	-----	87898-3066	-----	-----	-----	30	----	6	76.20	73.66	11.94	8.13

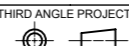
THIS DRAWING CONTAINS INFORMATION THAT IS PROPRIETARY TO MOLEX ELECTRONIC TECHNOLOGIES, LLC AND SHOULD NOT BE USED WITHOUT WRITTEN PERMISSION												
DIMENSION UNITS		SCALE		CURRENT REV DESC:								
mm		NTS										
GENERAL TOLERANCES (UNLESS SPECIFIED)				EC NO: 698212 DRWN: DANUSA 2022/03/03 CHK'D: DANUSA 2022/03/04 APPR: MRAMAKRISHNA 2022/03/04				CUSTOM HEADER 2.54MM PITCH SINGLE ROW SINGLE WAFER SMT HEADER				
		MM	INCH									
4 PLACES	±		±	INITIAL REVISION: DRWN: SKLIM01 2005/10/26 APPR: PTLIM 2005/11/07				DOCUMENT NUMBER		DOC TYPE	DOC PART	REVISION
3 PLACES	±		±					SD-87898-003		PSD	001	C1
2 PLACES	±	0.2	±	DRAFT WHERE APPLICABLE MUST REMAIN WITHIN DIMENSIONS				MATERIAL NUMBER		CUSTOMER		SHEET NUMBER
1 PLACE	±		±					SEE TABLE		GENERAL MARKET		13 OF 17
0 PLACES	±		±	THIRD ANGLE PROJECTION 		DRAWING	SERIES					
ANGULAR TOL		± 3.0°		A3-SIZE		87898						

PACKAGING OPTION PART NO.						CKT SIZE	VOID POSITION	PLATING TYPE	DIMENSION			
TRAY WITHOUT CAP	TRAY WITH CAP	TUBE WITHOUT CAP	TUBE WITH CAP	TAPE & REEL WITHOUT CAP	TAPE & REEL WITH CAP				A	B	F	M
-----	-----	87898-3161	-----	-----	-----	31	----	1	78.74	76.20	11.94	8.13
-----	-----	87898-3162	-----	-----	-----	31	----	2	78.74	76.20	11.94	8.13
-----	-----	87898-3164	-----	-----	-----	31	----	4	78.74	76.20	11.94	8.13
-----	-----	87898-3165	-----	-----	-----	31	----	5	78.74	76.20	11.94	8.13
-----	-----	87898-3166	-----	-----	-----	31	----	6	78.74	76.20	11.94	8.13
-----	-----	87898-3261	-----	-----	-----	32	----	1	81.28	78.74	11.94	8.13
-----	-----	87898-3262	-----	-----	-----	32	----	2	81.28	78.74	11.94	8.13
-----	-----	87898-3264	-----	-----	-----	32	----	4	81.28	78.74	11.94	8.13
-----	-----	87898-3265	-----	-----	-----	32	----	5	81.28	78.74	11.94	8.13
-----	-----	87898-3266	-----	-----	-----	32	----	6	81.28	78.74	11.94	8.13
-----	-----	87898-3361	-----	-----	-----	33	----	1	83.82	81.28	11.94	8.13
-----	-----	87898-3362	-----	-----	-----	33	----	2	83.82	81.28	11.94	8.13
-----	-----	87898-3364	-----	-----	-----	33	----	4	83.82	81.28	11.94	8.13
-----	-----	87898-3365	-----	-----	-----	33	----	5	83.82	81.28	11.94	8.13
-----	-----	87898-3366	-----	-----	-----	33	----	6	83.82	81.28	11.94	8.13

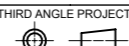
THIS DRAWING CONTAINS INFORMATION THAT IS PROPRIETARY TO MOLEX ELECTRONIC TECHNOLOGIES, LLC AND SHOULD NOT BE USED WITHOUT WRITTEN PERMISSION												
DIMENSION UNITS		SCALE		CURRENT REV DESC:								
mm		NTS										
GENERAL TOLERANCES (UNLESS SPECIFIED)				EC NO: 698212 DRWN: DANUSA 2022/03/03 CHK'D: DANUSA 2022/03/04 APPR: MRAMAKRISHNA 2022/03/04				CUSTOM HEADER 2.54MM PITCH SINGLE ROW SINGLE WAFER SMT HEADER				
		MM	INCH									
4 PLACES	±		±	INITIAL REVISION: DRWN: SKLIM01 2005/10/26 APPR: PTLIM 2005/11/07				DOCUMENT NUMBER		DOC TYPE	DOC PART	REVISION
3 PLACES	±		±					SD-87898-003		PSD	001	C1
2 PLACES	±	0.2	±	DRAFT WHERE APPLICABLE MUST REMAIN WITHIN DIMENSIONS				MATERIAL NUMBER		CUSTOMER		SHEET NUMBER
1 PLACE	±		±					SEE TABLE		GENERAL MARKET		14 OF 17
0 PLACES	±		±	THIRD ANGLE PROJECTION		DRAWING	SERIES	CUSTOMER		SHEET NUMBER		
ANGULAR TOL		± 3.0°				A3-SIZE	87898	GENERAL MARKET		14 OF 17		

PACKAGING OPTION PART NO.						CKT SIZE	VOID POSITION	PLATING TYPE	DIMENSION			
TRAY WITHOUT CAP	TRAY WITH CAP	TUBE WITHOUT CAP	TUBE WITH CAP	TAPE & REEL WITHOUT CAP	TAPE & REEL WITH CAP				A	B	F	M
-----	-----	87898-3461	-----	-----	-----	34	----	1	86.36	83.82	11.94	8.13
-----	-----	87898-3462	-----	-----	-----	34	----	2	86.36	83.82	11.94	8.13
-----	-----	87898-3464	-----	-----	-----	34	----	4	86.36	83.82	11.94	8.13
-----	-----	87898-3465	-----	-----	-----	34	----	5	86.36	83.82	11.94	8.13
-----	-----	87898-3466	-----	-----	-----	34	----	6	86.36	83.82	11.94	8.13
-----	-----	87898-3561	-----	-----	-----	35	----	1	88.90	86.36	11.94	8.13
-----	-----	87898-3562	-----	-----	-----	35	----	2	88.90	86.36	11.94	8.13
-----	-----	87898-3564	-----	-----	-----	35	----	4	88.90	86.36	11.94	8.13
-----	-----	87898-3565	-----	-----	-----	35	----	5	88.90	86.36	11.94	8.13
-----	-----	87898-3566	-----	-----	-----	35	----	6	88.90	86.36	11.94	8.13
-----	-----	87898-3661	-----	-----	-----	36	----	1	91.44	88.90	11.94	8.13
-----	-----	87898-3662	-----	-----	-----	36	----	2	91.44	88.90	11.94	8.13
-----	-----	87898-3664	-----	-----	-----	36	----	4	91.44	88.90	11.94	8.13
-----	-----	87898-3665	-----	-----	-----	36	----	5	91.44	88.90	11.94	8.13
-----	-----	87898-3666	-----	-----	-----	36	----	6	91.44	88.90	11.94	8.13

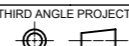
THIS DRAWING CONTAINS INFORMATION THAT IS PROPRIETARY TO MOLEX ELECTRONIC TECHNOLOGIES, LLC AND SHOULD NOT BE USED WITHOUT WRITTEN PERMISSION												
DIMENSION UNITS		SCALE		CURRENT REV DESC:								
mm		NTS										
GENERAL TOLERANCES (UNLESS SPECIFIED)				EC NO: 698212 DRWN: DANUSA 2022/03/03 CHK'D: DANUSA 2022/03/04 APPR: MRAMAKRISHNA 2022/03/04				CUSTOM HEADER 2.54MM PITCH SINGLE ROW SINGLE WAFER SMT HEADER				
		MM	INCH									
4 PLACES	±		±	INITIAL REVISION: DRWN: SKLIM01 2005/10/26 APPR: PTLIM 2005/11/07				DOCUMENT NUMBER		DOC TYPE	DOC PART	REVISION
3 PLACES	±		±					SD-87898-003		PSD	001	C1
2 PLACES	±	0.2	±	DRAFT WHERE APPLICABLE MUST REMAIN WITHIN DIMENSIONS				MATERIAL NUMBER		CUSTOMER		SHEET NUMBER
1 PLACE	±		±					SEE TABLE		GENERAL MARKET		15 OF 17
0 PLACES	±		±	THIRD ANGLE PROJECTION		DRAWING	SERIES	CUSTOMER		SHEET NUMBER		
ANGULAR TOL ± 3.0°				A3-SIZE	87898	SEE TABLE		GENERAL MARKET		15 OF 17		

PACKAGING OPTION PART NO.						CKT SIZE	VOID POSITION	PLATING TYPE	DIMENSION			
TRAY WITHOUT CAP	TRAY WITH CAP	TUBE WITHOUT CAP	TUBE WITH CAP	TAPE & REEL WITHOUT CAP	TAPE & REEL WITH CAP				A	B	F	M
-----	-----	87898-3761	-----	-----	-----	37	----	1	93.98	91.44	11.94	8.13
-----	-----	87898-3762	-----	-----	-----	37	----	2	93.98	91.44	11.94	8.13
-----	-----	87898-3764	-----	-----	-----	37	----	4	93.98	91.44	11.94	8.13
-----	-----	87898-3765	-----	-----	-----	37	----	5	93.98	91.44	11.94	8.13
-----	-----	87898-3766	-----	-----	-----	37	----	6	93.98	91.44	11.94	8.13
-----	-----	87898-3861	-----	-----	-----	38	----	1	96.52	93.98	11.94	8.13
-----	-----	87898-3862	-----	-----	-----	38	----	2	96.52	93.98	11.94	8.13
-----	-----	87898-3864	-----	-----	-----	38	----	4	96.52	93.98	11.94	8.13
-----	-----	87898-3865	-----	-----	-----	38	----	5	96.52	93.98	11.94	8.13
-----	-----	87898-3866	-----	-----	-----	38	----	6	96.52	93.98	11.94	8.13
-----	-----	87898-3961	-----	-----	-----	39	----	1	99.06	96.52	11.94	8.13
-----	-----	87898-3962	-----	-----	-----	39	----	2	99.06	96.52	11.94	8.13
-----	-----	87898-3964	-----	-----	-----	39	----	4	99.06	96.52	11.94	8.13
-----	-----	87898-3965	-----	-----	-----	39	----	5	99.06	96.52	11.94	8.13
-----	-----	87898-3966	-----	-----	-----	39	----	6	99.06	96.52	11.94	8.13

THIS DRAWING CONTAINS INFORMATION THAT IS PROPRIETARY TO MOLEX ELECTRONIC TECHNOLOGIES, LLC AND SHOULD NOT BE USED WITHOUT WRITTEN PERMISSION												
DIMENSION UNITS		SCALE		CURRENT REV DESC:								
mm		NTS										
GENERAL TOLERANCES (UNLESS SPECIFIED)				EC NO: 698212 DRWN: DANUSA 2022/03/03 CHK'D: DANUSA 2022/03/04 APPR: MRAMAKRISHNA 2022/03/04				CUSTOM HEADER 2.54MM PITCH SINGLE ROW SINGLE WAFER SMT HEADER				
		MM	INCH									
4 PLACES	±		±	INITIAL REVISION: DRWN: SKLIM01 2005/10/26 APPR: PTLIM 2005/11/07				DOCUMENT NUMBER		DOC TYPE	DOC PART	REVISION
3 PLACES	±		±					SD-87898-003		PSD	001	C1
2 PLACES	±	0.2	±	DRAFT WHERE APPLICABLE MUST REMAIN WITHIN DIMENSIONS				MATERIAL NUMBER		CUSTOMER		SHEET NUMBER
1 PLACE	±		±					SEE TABLE		GENERAL MARKET		16 OF 17
0 PLACES	±		±	THIRD ANGLE PROJECTION		DRAWING	SERIES	A3-SIZE		87898		
ANGULAR TOL		± 3.0°		DRAWING		SERIES		MATERIAL NUMBER		CUSTOMER		

PACKAGING OPTION PART NO.						CKT SIZE	VOID POSITION	PLATING TYPE	DIMENSION			
TRAY WITHOUT CAP	TRAY WITH CAP	TUBE WITHOUT CAP	TUBE WITH CAP	TAPE & REEL WITHOUT CAP	TAPE & REEL WITH CAP				A	B	F	M
-----	-----	87898-4061	-----	-----	-----	40	----	1	101.6	99.06	11.94	8.13
-----	-----	87898-4062	-----	-----	-----	40	----	2	101.6	99.06	11.94	8.13
-----	-----	87898-4064	-----	-----	-----	40	----	4	101.6	99.06	11.94	8.13
-----	-----	87898-4065	-----	-----	-----	40	----	5	101.6	99.06	11.94	8.13
-----	-----	87898-4066	-----	-----	-----	40	----	6	101.6	99.06	11.94	8.13

E

E

D

D

C

C

B

B

A

A

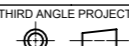
THIS DRAWING CONTAINS INFORMATION THAT IS PROPRIETARY TO MOLEX ELECTRONIC TECHNOLOGIES, LLC AND SHOULD NOT BE USED WITHOUT WRITTEN PERMISSION												
DIMENSION UNITS		SCALE		CURRENT REV DESC:								
mm		NTS										
GENERAL TOLERANCES (UNLESS SPECIFIED)				EC NO: 698212 DRWN: DANUSA 2022/03/03 CHK'D: DANUSA 2022/03/04 APPR: MRAMAKRISHNA 2022/03/04				CUSTOM HEADER 2.54MM PITCH SINGLE ROW SINGLE WAFER SMT HEADER				
		MM	INCH									
4 PLACES	±		±	INITIAL REVISION: DRWN: SKLIM01 2005/10/26 APPR: PTLIM 2005/11/07				DOCUMENT NUMBER		DOC TYPE	DOC PART	REVISION
3 PLACES	±		±					SD-87898-003		PSD	001	C1
2 PLACES	±	0.2	±	DRAFT WHERE APPLICABLE MUST REMAIN WITHIN DIMENSIONS				MATERIAL NUMBER		CUSTOMER		SHEET NUMBER
1 PLACE	±		±					SEE TABLE		GENERAL MARKET		17 OF 17
0 PLACES	±		±	THIRD ANGLE PROJECTION		DRAWING	SERIES					
ANGULAR TOL ± 3.0°						A3-SIZE	87898					

DOCUMENT STATUS	P1	RELEASE DATE	2022/03/04	09:00:56
-----------------	----	--------------	------------	----------