

May 2002

Features

- Full CMOS Design
- Six Transistor Memory Cell
- Low Standby Supply Current100 μ A
- Low Operating Supply Current..... 20mA
- Fast Address Access Time 150ns
- Low Data Retention Supply Voltage 2.0V
- CMOS/TTL Compatible Inputs/Outputs
- JEDEC Approved Pinout
- Equal Cycle and Access Times
- No Clocks or Strobes Required
- Gated Inputs
- No Pull-Up or Pull-Down Resistors Required
- Easy Microprocessor Interfacing
- Dual Chip Enable Control

Description

The HM-65642 is a CMOS 8192 x 8-bit Static Random Access Memory. The pinout is the JEDEC 28 pin, 8-bit wide standard, which allows easy memory board layouts which accommodate a variety of industry standard ROM, PROM, EPROM, EEPROM and RAMs. The HM-65642 is ideally suited for use in microprocessor based systems. In particular, interfacing with the Intersil 80C86 and 80C88 microprocessors is simplified by the convenient output enable (\bar{G}) input.

The HM-65642 is a full CMOS RAM which utilizes an array of six transistor (6T) memory cells for the most stable and lowest possible standby supply current over the full military temperature range.

Ordering Information

PACKAGE	TEMPERATURE RANGE	(NOTE 1) 150ns/75 μ A	(NOTE 1) 150ns/150 μ A	(NOTE 1) 200ns/250 μ A	PKG. NO.
CERDIP	-40 $^{\circ}$ C to +85 $^{\circ}$ C	-	HM1-65642-9	-	F28.6
JAN#	-55 $^{\circ}$ C to +125 $^{\circ}$ C	29205BXA	-	-	F28.6

NOTE:

1. Access Time/Data Retention Supply Current.

Pinout

HM-65642 (CERDIP)
TOP VIEW

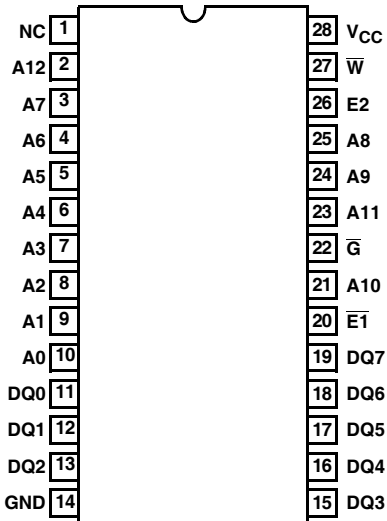

PIN	DESCRIPTION
A	Address Input
DQ	Data Input/Output
$\bar{E}1$	Chip Enable
E2	Chip Enable
\bar{W}	Write Enable
\bar{G}	Output Enable
NC	No Connections
GND	Ground
VCC	Power

Functional Diagram

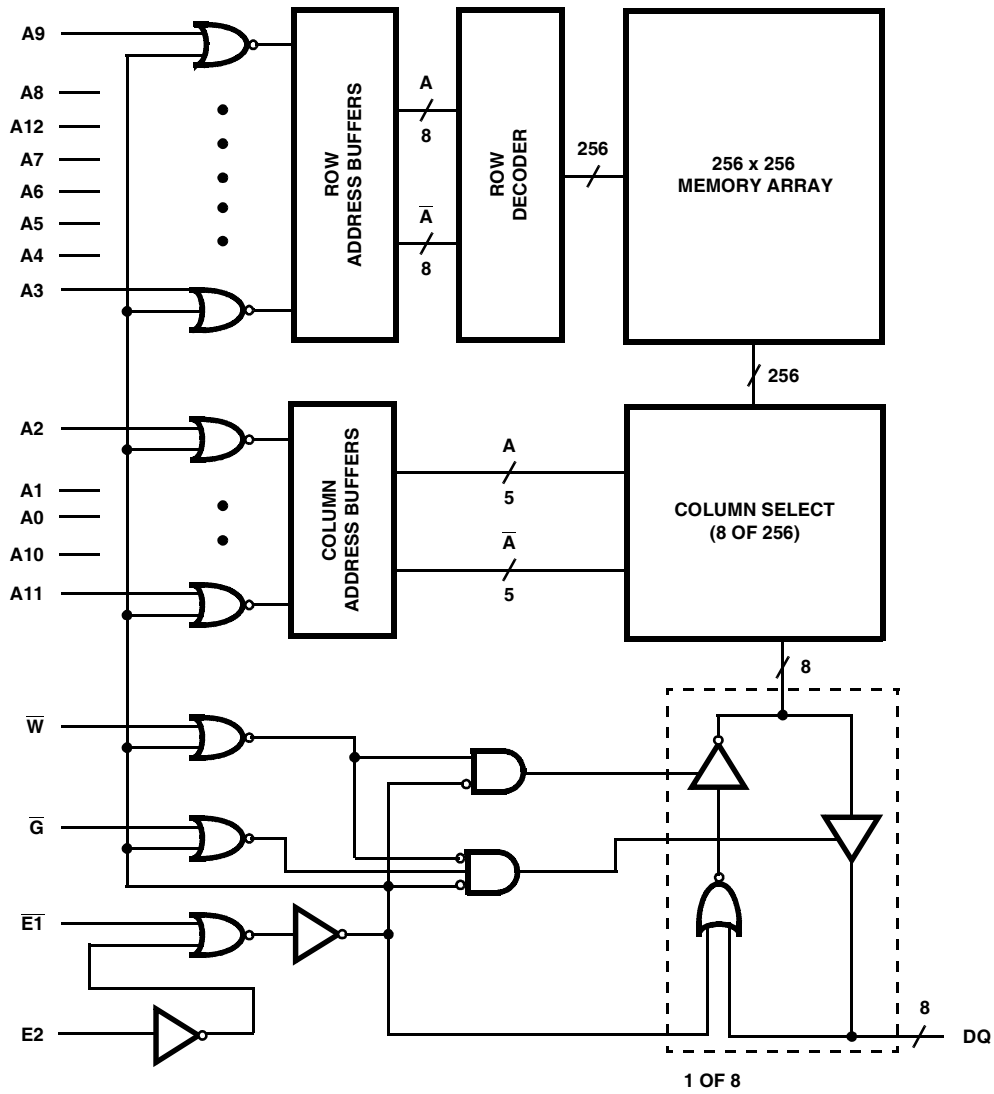

TRUTH TABLE

MODE	E1̄	E2	W̄	Ḡ
Standby (CMOS)	X	GND	X	X
Standby (TTL)	V _{IH}	X	X	X
	X	V _{IL}	X	X
Enable (High Z)	V _{IL}	V _{IH}	V _{IH}	V _{IH}
Write	V _{IL}	V _{IH}	V _{IL}	X
Read	V _{IL}	V _{IH}	V _{IH}	V _{IL}

HM-65642

Absolute Maximum Ratings

Supply Voltage +7.0V
 Input or Output Voltage Applied for All Grades GND -0.3V to $V_{CC} + 0.3V$
 Typical Derating Factor 5mA/MHz Increase in ICCOP
 ESD Classification Class 1

Thermal Information

Thermal Resistance (Typical)
 CERDIP Package θ_{JA} 45°C/W θ_{JC} 8°C/W
 Maximum Storage Temperature Range -65°C to +150°C
 Maximum Junction Temperature +175°C
 Maximum Lead Temperature (Soldering 10s) +300°C

Die Characteristics

Gate Count 101,000 Gates

CAUTION: Stresses above those listed in "Absolute Maximum Ratings" may cause permanent damage to the device. This is a stress only rating and operation of the device at these or any other conditions above those indicated in the operational sections of this specification is not implied.

Operating Conditions

Operating Voltage Range +4.5V to +5.5V Input Low Voltage -0.3V to +0.8V
 Operating Temperature Range -40°C to +85°C Input High Voltage +2.2V to $V_{CC} + 0.3V$
 HM-65642-9

DC Electrical Specifications $V_{CC} = 5V \pm 10\%$; $T_A = -40^\circ C$ to $+85^\circ C$ (HM-65642-9)

SYMBOL	PARAMETER	LIMITS		UNITS	TEST CONDITIONS
		MIN	MAX		
ICCSB1	Standby Supply Current (CMOS)	-	250	μA	E2 = GND, $V_{CC} = 5.5V$
ICCSB2	Standby Supply Current (TTL)	-	5	mA	E2 = 0.8V or $\bar{E}1 = 2.2V$, $V_{CC} = 5.5V$
ICCDR	Data Retention Supply Current	-	150	μA	E2 = GND, $V_{CC} = 2.0V$
ICcen	Enabled Supply Current	-	5	mA	E2 = 2.2V, $\bar{E}1 = 0.8V$, $V_{CC} = 5.5V$, IIO = 0mA
ICcop	Operating Supply Current (Note 1)	-	20	mA	f = 1MHz, $\bar{E}1 = 0.8V$, E2 = 2.2V, $V_{CC} = 5.5V$, IIO = 0mA
II	Input Leakage Current	-1.0	+1.0	μA	VI = V_{CC} or GND, $V_{CC} = 5.5V$
IIOZ	Input/Output Leakage Current	-1.0	+1.0	μA	E2 = GND, VIO = V_{CC} or GND, $V_{CC} = 5.5V$
VCCDR	Data Retention Supply Voltage	2.0	-	V	
VOH1	Output High Voltage	2.4	-	V	IOH = -1.0mA, $V_{CC} = 4.5V$
VOH2	Output High Voltage (Note 2)	$V_{CC} - 0.4$	-	V	IOH = -100 μA , $V_{CC} = 4.5V$
VOL	Output Low Voltage	-	0.4	V	IOL = 4.0mA, $V_{CC} = 4.5V$

Capacitance $T_A = +25^\circ C$

SYMBOL	PARAMETER	MAX	UNITS	TEST CONDITIONS
CI	Input Capacitance (Note 2)	12	pF	f = 1MHz, All measurements are referenced to device GND
CIO	Input/Output Capacitance (Note 2)	14	pF	

NOTES:

1. Typical derating 5mA/MHz increase in ICCOP.
2. Tested at initial design and after major design changes.

HM-65642

AC Electrical Specifications $V_{CC} = 5V \pm 10\%$; $T_A = -40^{\circ}C$ to $+85^{\circ}C$ (HM-65642-9)

SYMBOL	PARAMETER		LIMITS		UNITS	TEST CONDITIONS	
			MIN	MAX			
READ CYCLE							
(1) TAVAX	Read Cycle Time		150	-	ns	(Notes 1, 3)	
(2) TAVQV	Address Access Time		-	150	ns	(Notes 1, 3)	
(3) TE1LQV	Chip Enable Access Time	$\bar{E}1$	-	150	ns	(Notes 2, 3)	
(4) TE2HQV	Chip Enable Access Time	E2	-	150	ns	(Notes 1, 3)	
(5) TGLQV	Output Enable Access Time		-	70	ns	(Notes 1, 3)	
(6) TE1LQX	Chip Enable Valid to Output On	$\bar{E}1$	10	-	ns	(Notes 2, 3)	
(7) TE2HQX	Chip Enable Valid to Output On	E2	10	-	ns	(Notes 2, 3)	
(8) TGLQX	Output Enable Valid to Output On		5	-	ns	(Notes 2, 3)	
(9) TE1HQZ	Chip Enable Not Valid to Output Off	$\bar{E}1$	-	50	ns	(Notes 2, 3)	
(10) TE2LQZ	Chip Enable Not Valid to Output Off	E2	-	60	ns	(Notes 2, 3)	
(11) TGHQZ	Output Enable Not Valid to Output Off		-	50	ns	(Notes 2, 3)	
(12) TAXQX	Output Hold From Address Change		10	-	ns	(Notes 2, 3)	
WRITE CYCLE							
(13) TAVAX	Write Cycle Time		150	-	ns	(Notes 1, 3)	
(14) TWLWH	Write Pulse Width		90	-	ns	(Notes 1, 3)	
(15) TE1LE1H	Chip Enable to End of Write	$\bar{E}1$	90	-	ns	(Notes 1, 3)	
(16) TE2HE2L	Chip Enable to End of Write	E2	90	-	ns	(Notes 1, 3)	
(17) TAVWL	Address Setup Time	Late Write	0	-	ns	(Notes 1, 3)	
(18) TAVE1L	Address Setup Time	Early Write	$\bar{E}1$	0	-	ns	(Notes 1, 3)
(19) TAVE2H	Address Setup Time	Early Write	E2	0	-	ns	(Notes 1, 3)
(20) TWHAX	Write Recovery Time	Late Write	10	-	ns	(Notes 1, 3)	
(21) TE1HAX	Write Recovery Time	Early Write	$\bar{E}1$	10	-	ns	(Notes 1, 3)
(22) TE2LAX	Write Recovery Time	Early Write	E2	10	-	ns	(Notes 1, 3)
(23) TDVWH	Data Setup Time	Late Write	60	-	ns	(Notes 1, 3)	
(24) TDVE1H	Data Setup Time	Early Write	$\bar{E}1$	60	-	(Notes 1, 3)	
(25) TDVE2L	Data Setup Time	Early Write	E2	60	-	ns	(Notes 1, 3)
(26) TWHDX	Data Hold Time	Late Write	5	-	ns	(Notes 1, 3)	
(27) TE1HDX	Data Hold Time	Early Write	$\bar{E}1$	10	-	ns	(Notes 1, 3)
(28) TE2LDX	Data Hold Time	Early Write	E2	10	-	ns	(Notes 1, 3)
(29) TWLQZ	Write Enable Low to Output Off		-	50	ns	(Notes 2, 3)	
(30) TWHQX	Write Enable High to Output On		5	-	ns	(Notes 2, 3)	

NOTES:

- Input pulse levels: 0V to 3.0V; Input rise and fall times: 5ns (max); Input and output timing reference level: 1.5V; Output load: 1 TTL gate equivalent, $C_L = 50\text{pF}$ (min) - for C_L greater than 50pF, access time is derated by 0.15ns per pF.
- Tested at initial design and after major design changes.
- $V_{CC} = 4.5V$ and $5.5V$.

Low Voltage Data Retention

Intersil CMOS RAMs are designed with battery backup in mind. Data Retention voltage and supply current are guaranteed over the operating temperature range. The following rules ensure data retention:

1. The RAM must be kept disabled during data retention. This is accomplished by holding the E2 pin between -0.3V and GND.
2. During power-up and power-down transitions, E2 must be held between -0.3V and 10% of V_{CC} .
3. The RAM can begin operating one TAVAX after V_{CC} reaches the minimum operating voltage of 4.5V.

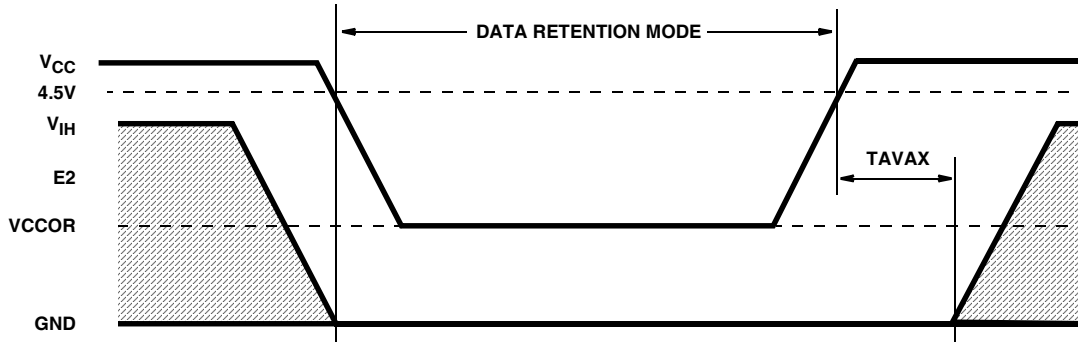

FIGURE 1. DATA RETENTION

Read Cycles

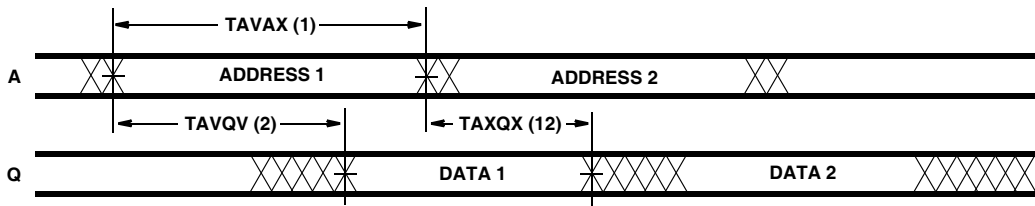

FIGURE 2. READ CYCLE I: \overline{W} , E2 HIGH; \overline{G} , $\overline{E1}$ LOW

Read Cycles

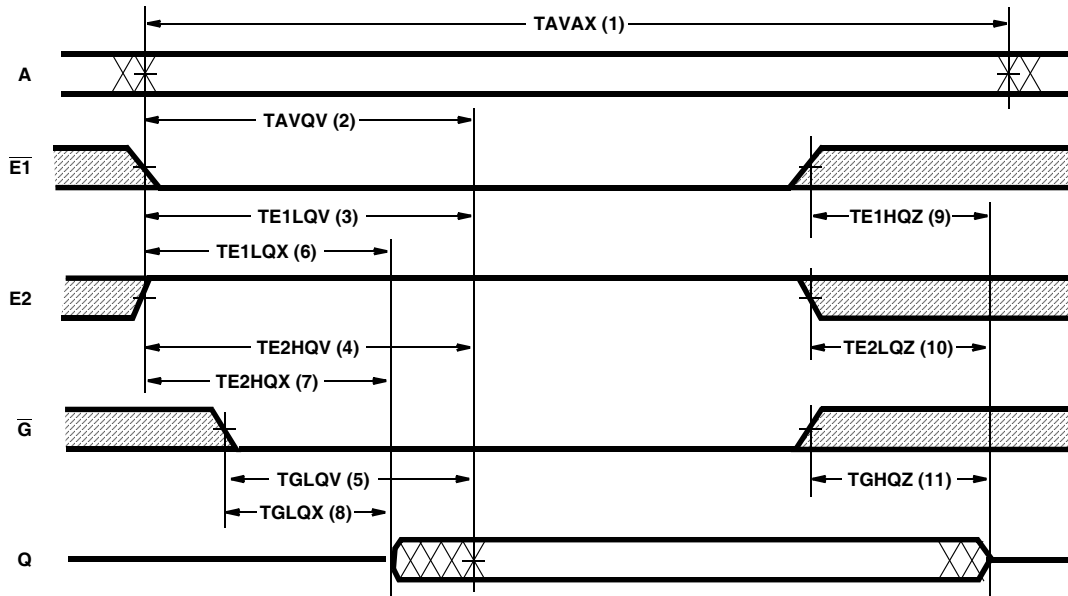

FIGURE 3. READ CYCLE II: \bar{W} HIGH

Write Cycles

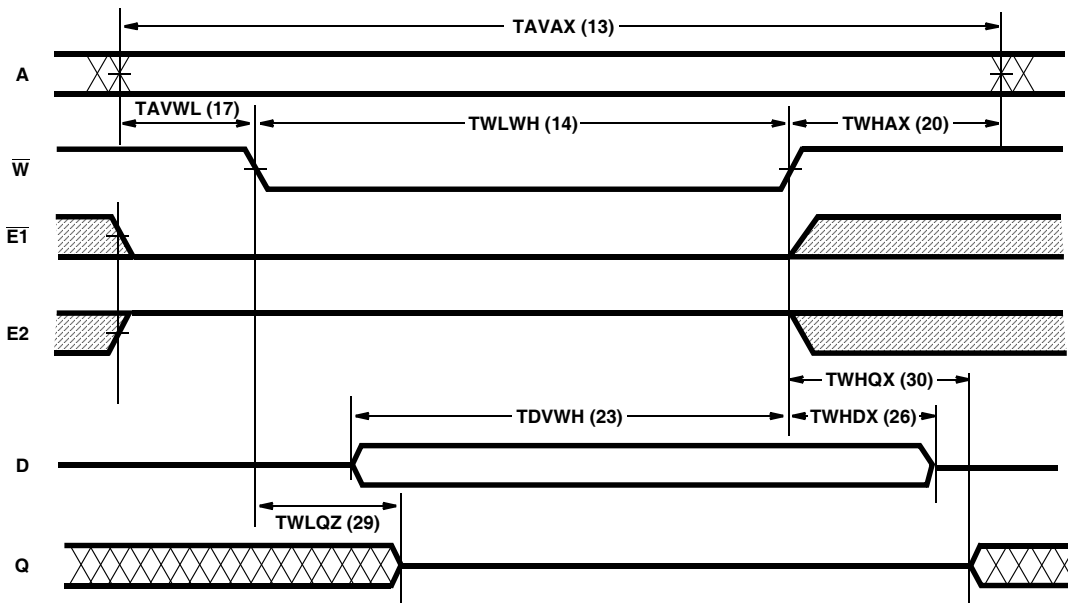

FIGURE 4. WRITE CYCLE I: LATE WRITE

Write Cycles

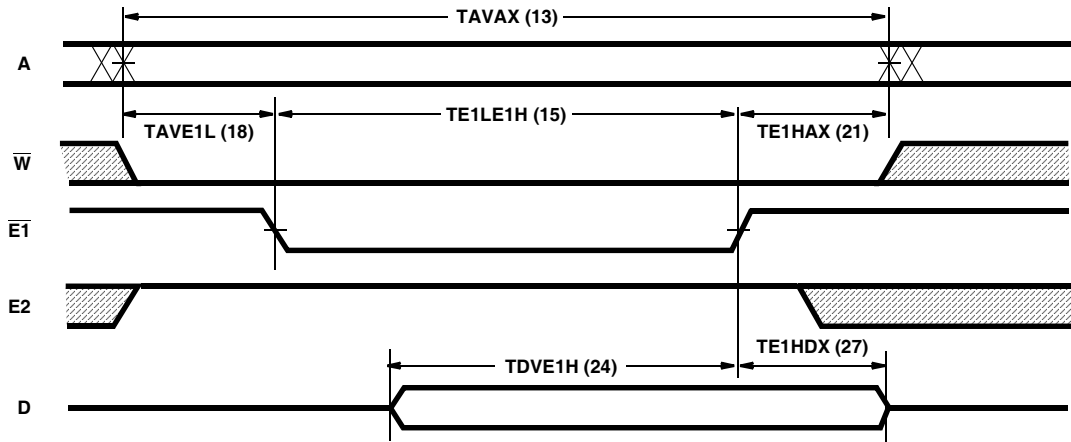

FIGURE 5. WRITE CYCLE II: EARLY WRITE - CONTROLLED BY $\bar{E}1$

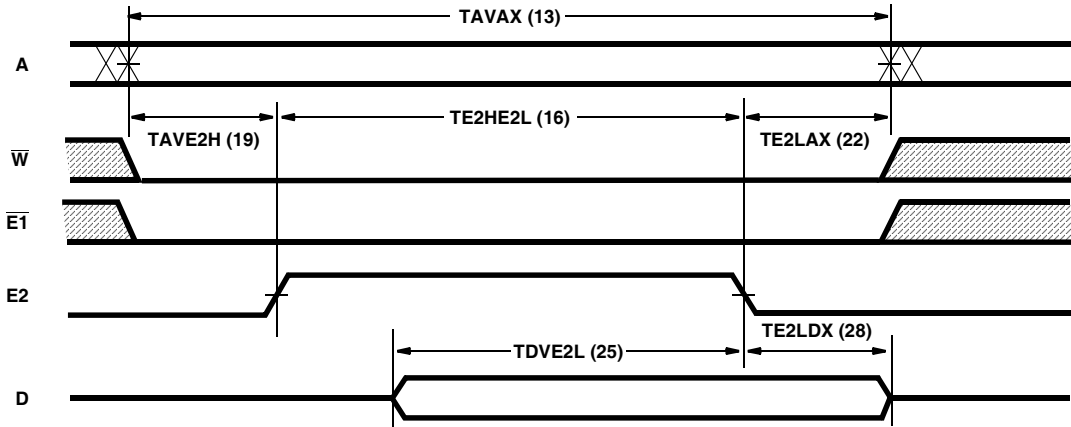

FIGURE 6. WRITE CYCLE III: EARLY WRITE - CONTROLLED BY E2

Typical Performance Curve

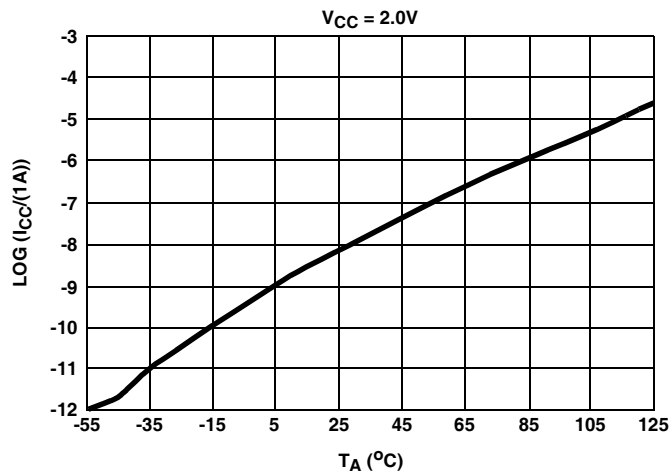

FIGURE 7. TYPICAL ICCDR vs T_A

All Intersil U.S. products are manufactured, assembled and tested utilizing ISO9000 quality systems.
Intersil Corporation's quality certifications can be viewed at www.intersil.com/design/quality

Intersil products are sold by description only. Intersil Corporation reserves the right to make changes in circuit design, software and/or specifications at any time without notice. Accordingly, the reader is cautioned to verify that data sheets are current before placing orders. Information furnished by Intersil is believed to be accurate and reliable. However, no responsibility is assumed by Intersil or its subsidiaries for its use; nor for any infringements of patents or other rights of third parties which may result from its use. No license is granted by implication or otherwise under any patent or patent rights of Intersil or its subsidiaries.

For information regarding Intersil Corporation and its products, see www.intersil.com