

Features

- Low C_{RES} / C_{IES} ratio (no cross conduction susceptibility)
- IGBT co-packaged with ultra fast free-wheeling diode
- High frequency operation

Applications

- High frequency inverters, UPS
- Motor drivers
- HF, SMPS and PFC in both hard switch and resonant topologies
- Welding
- Induction heating

Description

This IGBT utilizes the advanced PowerMESH™ process resulting in an excellent trade-off between switching performance and low on-state behavior.

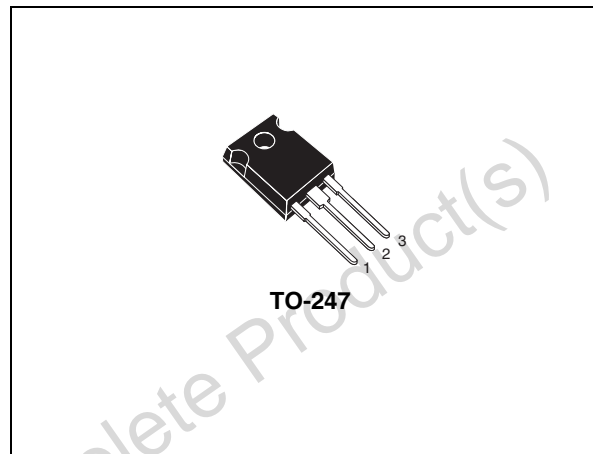

Figure 1. Internal schematic diagram

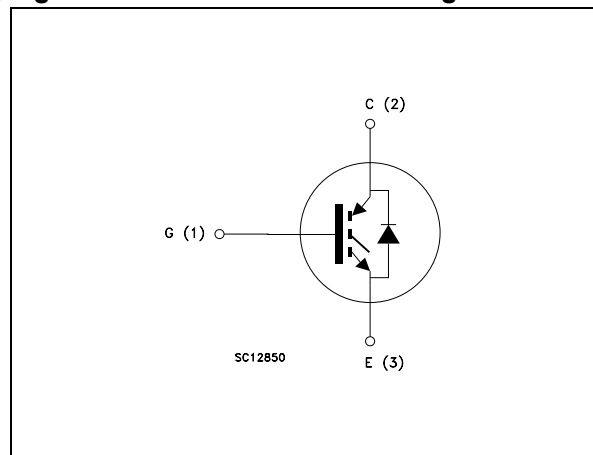

Table 1. Device summary

Order code	Marking	Package	Packaging
STGW40NC60WD	GW40NC60WD	TO-247	Tube

Contents

1	Electrical ratings	3
2	Electrical characteristics	4
	2.1 Electrical characteristics (curves)	7
3	Test circuit	10
4	Package mechanical data	11
5	Revision history	13

Obsolete Product(s) - Obsolete Product(s)

1 Electrical ratings

Table 2. Absolute maximum ratings

Symbol	Parameter	Value	Unit
V_{CES}	Collector-emitter voltage ($V_{GE} = 0$)	600	V
$I_C^{(1)}$	Collector current (continuous) at 25 °C	70	A
$I_C^{(1)}$	Collector current (continuous) at 100 °C	40	A
$I_{CL}^{(2)}$	Turn-off latching current	230	A
$I_{CP}^{(3)}$	Pulsed collector current	230	A
V_{GE}	Gate-emitter voltage	±20	V
I_F	Diode RMS forward current at $T_C=25$ °C	30	A
I_{FSM}	Surge non repetitive forward current ($t_p=10$ ms sinusoidal)	120	A
P_{TOT}	Total dissipation at $T_C = 25$ °C	250	W
T_j	Operating junction temperature	- 55 to 150	°C

1. Calculated according to the iterative formula:

$$I_C(T_C) = \frac{T_{JMAX} - T_C}{R_{THJ-C} \times V_{CESAT(MAX)}(T_C, I_C)}$$

2. $V_{clamp} = 80\%(V_{CES})$, $T_j = 150$ °C, $R_G = 10$ Ω, $V_{GE} = 15$ V

3. Pulse width limited by max. junction temperature allowed

Table 3. Thermal resistance

Symbol	Parameter	Value	Unit
$R_{thj-case}$	Thermal resistance junction-case max (IGBT)	0.5	°C/W
$R_{thj-case}$	Thermal resistance junction-case max (diode)	1.5	°C/W
$R_{thj-amb}$	Thermal resistance junction-ambient max	50	°C/W

2 Electrical characteristics

($T_{CASE}=25\text{ °C}$ unless otherwise specified)

Table 4. Static

Symbol	Parameter	Test conditions	Min.	Typ.	Max.	Unit
$V_{(BR)CES}$	Collector-emitter breakdown voltage ($V_{GE} = 0$)	$I_C = 1\text{ mA}$	600			V
$V_{CE(sat)}$	Collector-emitter saturation voltage	$V_{GE}= 15\text{ V}$, $I_C= 30\text{ A}$ $V_{GE}= 15\text{ V}$, $I_C= 30\text{ A}$, $T_C=125\text{ °C}$		2.1 1.9	2.5	V V
$V_{GE(th)}$	Gate threshold voltage	$V_{CE}= V_{GE}$, $I_C= 250\mu\text{A}$	3.75		5.75	V
I_{CES}	Collector-emitter cut-off current ($V_{GE} = 0$)	$V_{GE} = 600\text{ V}$ $V_{GE} = 600\text{ V}$, $T_C=125\text{ °C}$			500 5	μA mA
I_{GES}	Gate-emitter cut-off current ($V_{CE} = 0$)	$V_{GE} = \pm 20\text{ V}$			± 100	nA
g_{fs}	Forward transconductance	$V_{CE} = 15\text{ V}$, $I_C= 30\text{ A}$		20		S

Table 5. Dynamic

Symbol	Parameter	Test conditions	Min.	Typ.	Max.	Unit
C_{ies}	Input capacitance	$V_{CE} = 25\text{ V}$, $f = 1\text{ MHz}$, $V_{GE}= 0$		2900		pF
C_{oes}	Output capacitance			298		pF
C_{res}	Reverse transfer capacitance			59		pF
Q_g	Total gate charge	$V_{CE} = 390\text{ V}$, $I_C = 30\text{ A}$,		126		nC
Q_{ge}	Gate-emitter charge	$V_{GE} = 15\text{ V}$		16		nC
Q_{gc}	Gate-collector charge	(see Figure 18)		46		nC

Table 6. Switching on/off (inductive load)

Symbol	Parameter	Test conditions	Min.	Typ.	Max.	Unit
$t_{d(on)}$	Turn-on delay time	$V_{CC} = 390\text{ V}, I_C = 30\text{ A}$		33		ns
t_r	Current rise time	$R_G = 10\ \Omega, V_{GE} = 15\text{ V}$		12		ns
$(di/dt)_{on}$	Turn-on current slope	(see Figure 17)		2600		A/ μ s
$t_{d(on)}$	Turn-on delay timeE	$V_{CC} = 390\text{ V}, I_C = 30\text{ A}$		32		ns
t_r	Current rise time	$R_G = 10\ \Omega, V_{GE} = 15\text{ V},$ $T_C = 125\text{ }^\circ\text{C}$		14		ns
$(di/dt)_{on}$	Turn-on current slope	(see Figure 17)		2300		A/ μ s
$t_r(V_{off})$	Off voltage rise time	$V_{CC} = 390\text{ V}, I_C = 30\text{ A},$		26		ns
$t_{d(off)}$	Turn-off delay time	$R_{GE} = 10\ \Omega, V_{GE} = 15\text{ V}$		168		ns
t_f	Current fall time	(see Figure 17)		36		ns
$t_r(V_{off})$	Off voltage rise time	$V_{CC} = 390\text{ V}, I_C = 30\text{ A},$		54		ns
$t_{d(off)}$	Turn-off delay time	$R_{GE} = 10\ \Omega, V_{GE} = 15\text{ V},$ $T_C = 125\text{ }^\circ\text{C}$ (see Figure 17)		213		ns
t_f	Current fall time			67		ns

Table 7. Switching energy (inductive load)

Symbol	Parameter	Test conditions	Min	Typ.	Max	Unit
$E_{on}^{(1)}$	Turn-on switching losses	$V_{CC} = 390\text{ V}, I_C = 30\text{ A}$		302		μ J
$E_{off}^{(2)}$	Turn-off switching losses	$R_G = 10\ \Omega, V_{GE} = 15\text{ V}$		349		μ J
E_{ts}	Total switching losses	(see Figure 17)		651		μ J
$E_{on}^{(1)}$	Turn-on switching losses	$V_{CC} = 390\text{ V}, I_C = 30\text{ A}$		553		μ J
$E_{off}^{(2)}$	Turn-off switching losses	$R_G = 10\ \Omega, V_{GE} = 15\text{ V},$ $T_C = 125\text{ }^\circ\text{C}$		750		μ J
E_{ts}	Total switching losses	(see Figure 17)		1303		μ J

1. E_{on} is the turn-on losses when a typical diode is used in the test circuit in figure 2 E_{on} include diode recovery energy. If the IGBT is offered in a package with a co-pak diode, the co-pak diode is used as external diode. IGBTs & Diode are at the same temperature (25 °C and 125 °C)

2. Turn-off losses include also the tail of the collector current

Table 8. Collector-emitter diode

Symbol	Parameter	Test conditions	Min	Typ.	Max	Unit
V_F	Forward on-voltage	$I_F = 30\text{ A}$ $I_F = 30\text{ A}, T_C = 125\text{ °C}$		2.4		V
				1.8		V
t_{rr}	Reverse recovery time	$I_F = 30\text{ A}, V_R = 50\text{ V},$ $di/dt = 100\text{ A}/\mu\text{s}$ <i>(see Figure 20)</i>		45		ns
Q_{rr}	Reverse recovery charge			56		nC
I_{rrm}	Reverse recovery current			2.55		A
t_{rr}	Reverse recovery time	$I_F = 30\text{ A}, V_R = 50\text{ V},$ $T_C = 125\text{ °C},$ $di/dt = 100\text{ A}/\mu\text{s}$ <i>(see Figure 20)</i>		100		ns
Q_{rr}	Reverse recovery charge			290		nC
I_{rrm}	Reverse recovery current			5.8		A

2.1 Electrical characteristics (curves)

Figure 2. Output characteristics

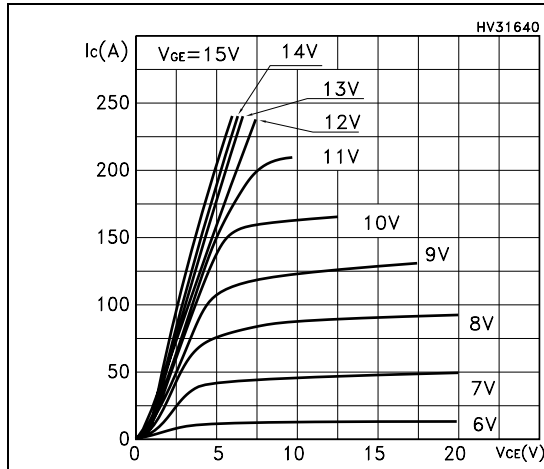

Figure 3. Transfer characteristics

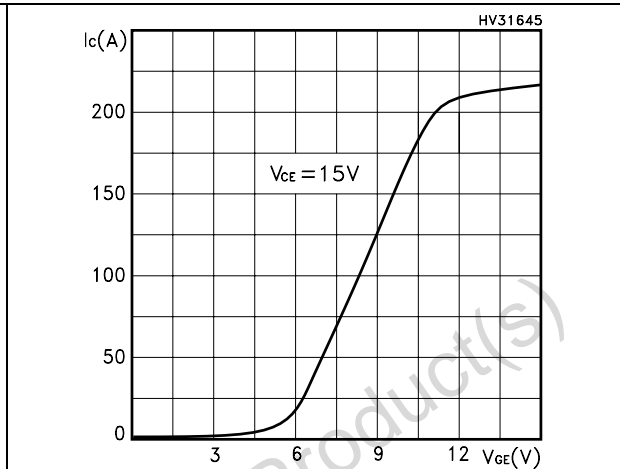

Figure 4. Transconductance

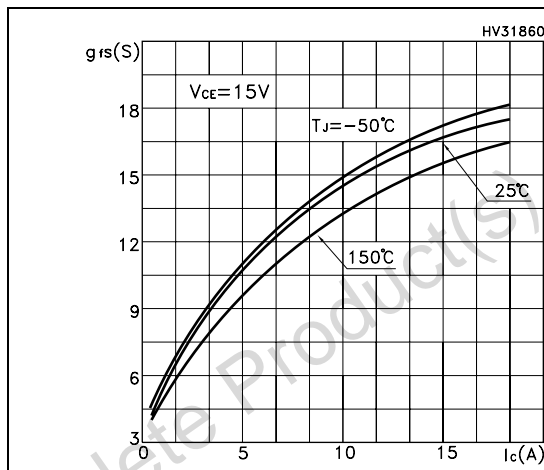

Figure 5. Collector-emitter on voltage vs temperature

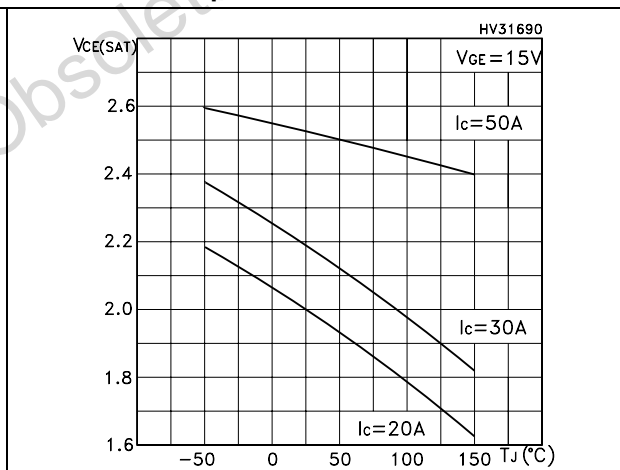

Figure 6. Collector-emitter on voltage vs collector current

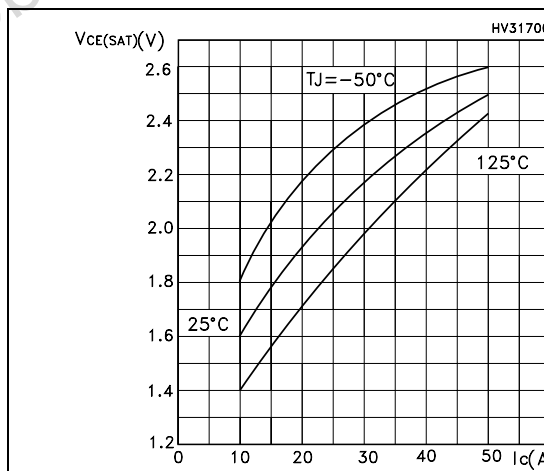

Figure 7. Normalized gate threshold vs temperature

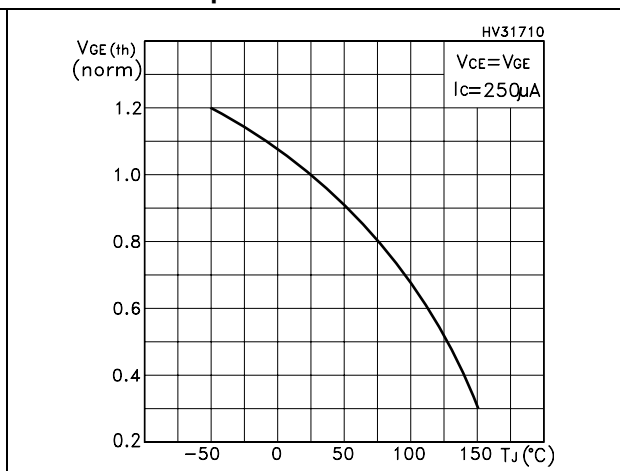

Figure 8. Normalized breakdown voltage vs temperature

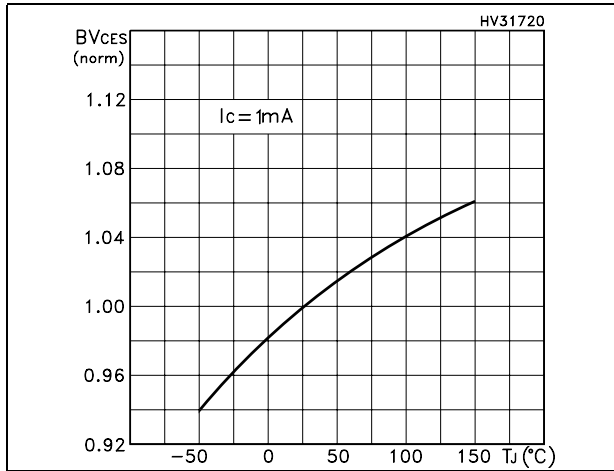

Figure 9. Gate charge vs gate-emitter voltage

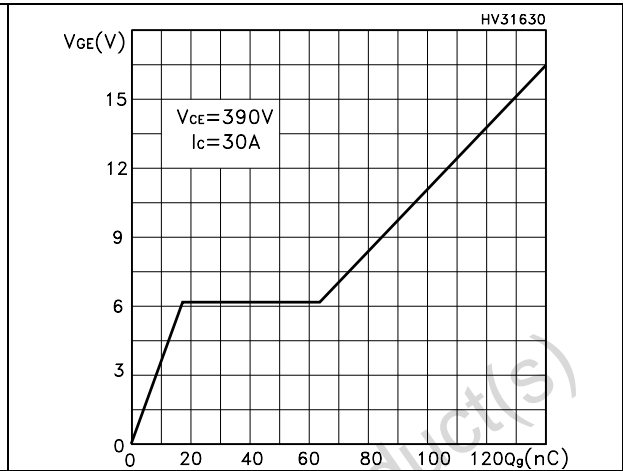

Figure 10. Capacitance variations

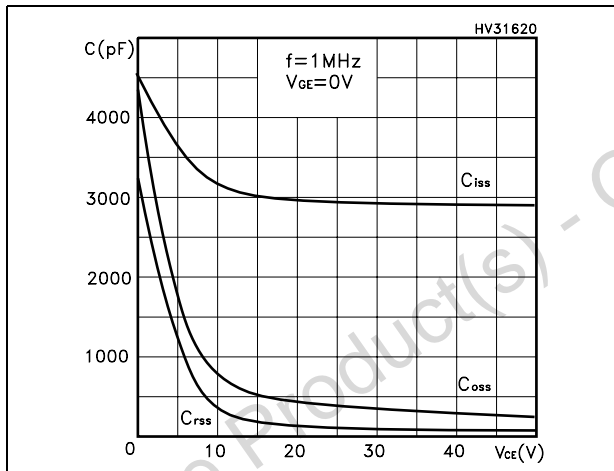

Figure 11. Switching losses vs temperature

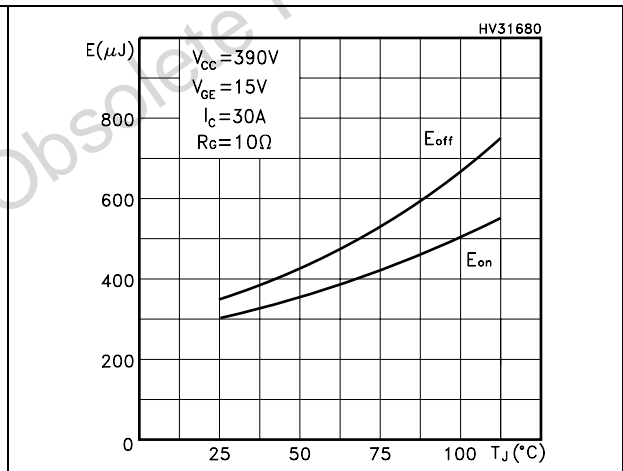

Figure 12. Switching losses vs gate resistance

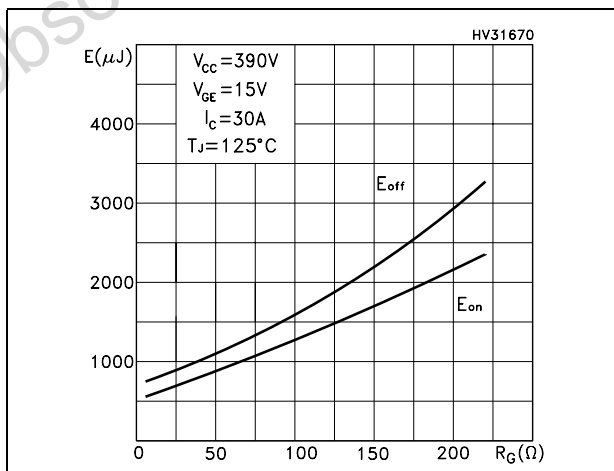

Figure 13. Switching losses vs collector current

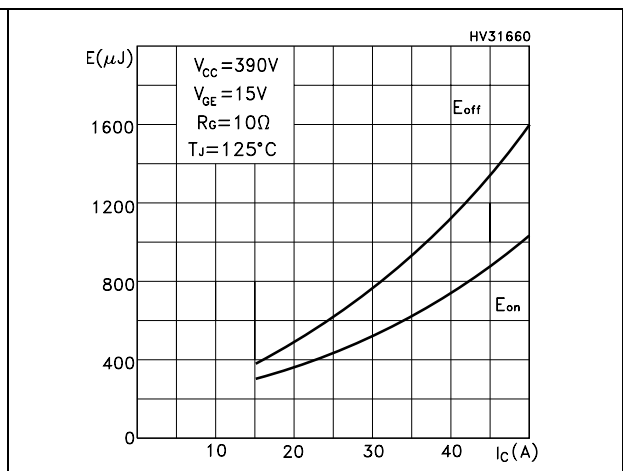

Figure 14. Thermal impedance

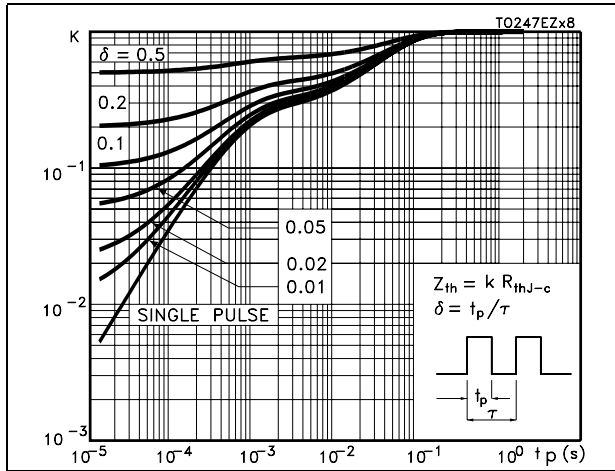

Figure 15. Turn-off SOA

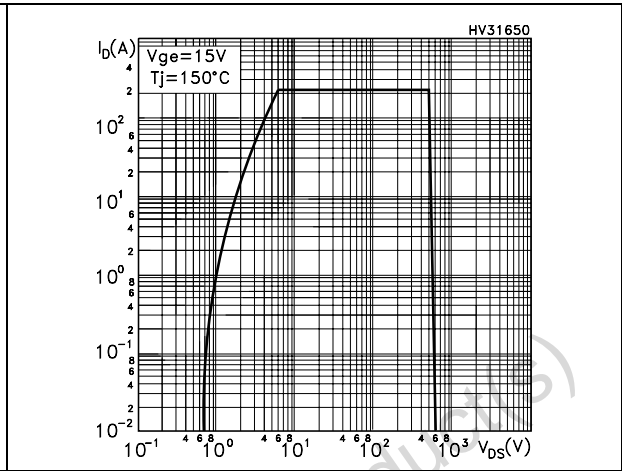
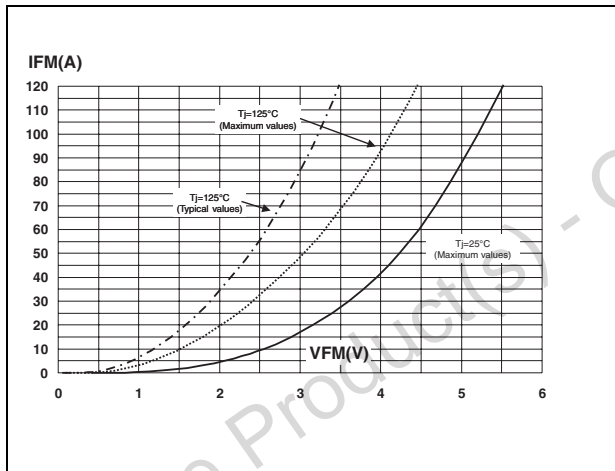

Figure 16. Emitter-collector diode characteristics



3 Test circuit

Figure 17. Test circuit for inductive load switching

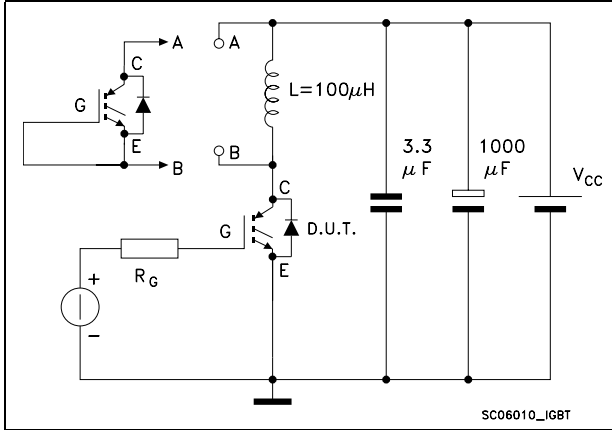

Figure 18. Gate charge test circuit

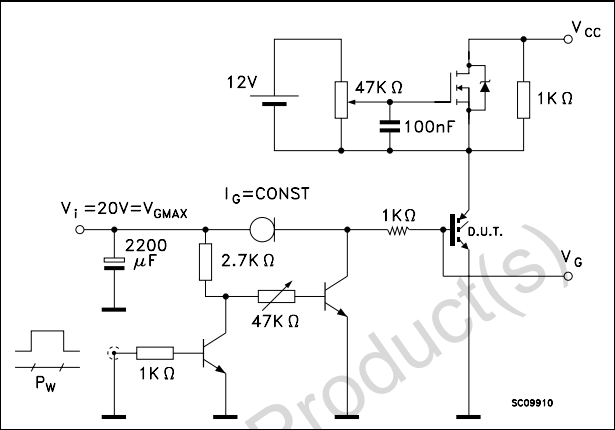

Figure 19. Switching waveforms

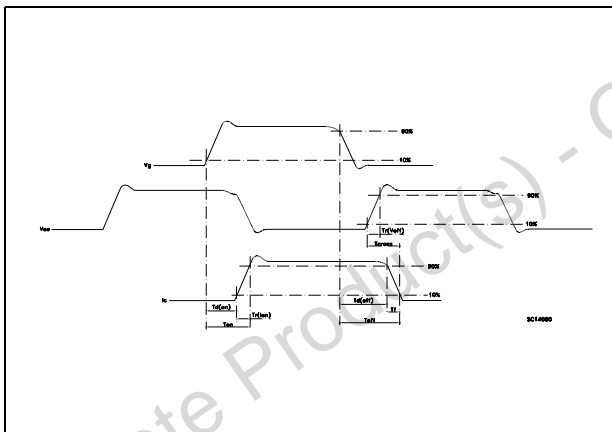
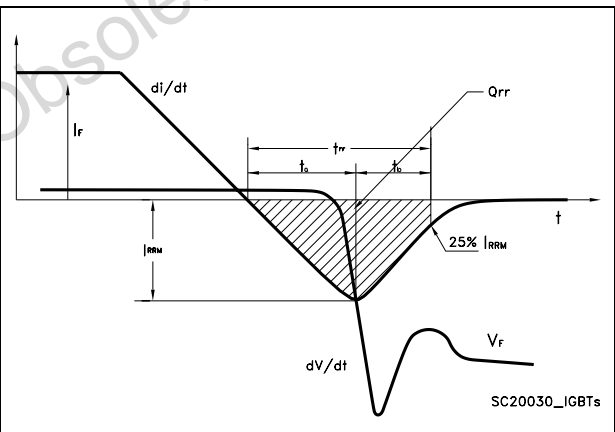

Figure 20. Diode recovery times waveform



4 Package mechanical data

In order to meet environmental requirements, ST offers these devices in ECOPACK® packages. These packages have a Lead-free second level interconnect. The category of second level interconnect is marked on the package and on the inner box label, in compliance with JEDEC Standard JESD97. The maximum ratings related to soldering conditions are also marked on the inner box label. ECOPACK is an ST trademark. ECOPACK specifications are available at: www.st.com

Obsolete Product(s) - Obsolete Product(s)

TO-247 mechanical data

Dim.	mm.		
	Min.	Typ	Max.
A	4.85		5.15
A1	2.20		2.60
b	1.0		1.40
b1	2.0		2.40
b2	3.0		3.40
c	0.40		0.80
D	19.85		20.15
E	15.45		15.75
e		5.45	
L	14.20		14.80
L1	3.70		4.30
L2		18.50	
øP	3.55		3.65
øR	4.50		5.50
S		5.50	

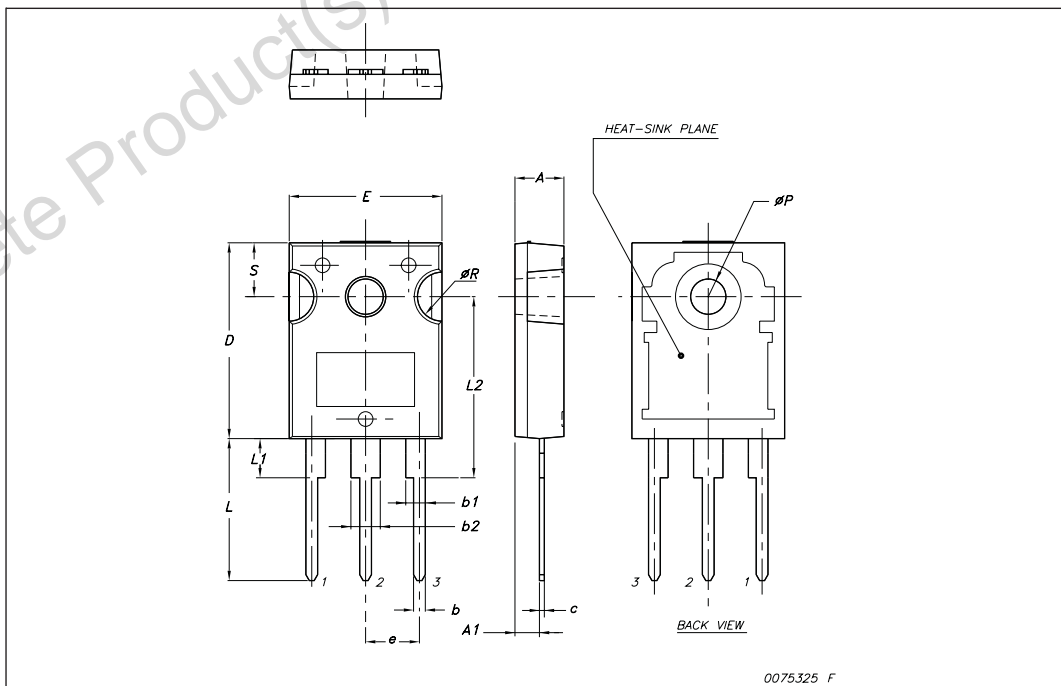

5 Revision history

Table 9. Document revision history

Date	Revision	Changes
8-Jun-2006	1	First release
08-Nov-2006	2	Modified <i>Dynamic</i>
01-Feb-2008	3	Updated <i>Table 7</i>
09-Jul-2008	4	Added new feature

Obsolete Product(s) - Obsolete Product(s)

Please Read Carefully:

Information in this document is provided solely in connection with ST products. STMicroelectronics NV and its subsidiaries ("ST") reserve the right to make changes, corrections, modifications or improvements, to this document, and the products and services described herein at any time, without notice.

All ST products are sold pursuant to ST's terms and conditions of sale.

Purchasers are solely responsible for the choice, selection and use of the ST products and services described herein, and ST assumes no liability whatsoever relating to the choice, selection or use of the ST products and services described herein.

No license, express or implied, by estoppel or otherwise, to any intellectual property rights is granted under this document. If any part of this document refers to any third party products or services it shall not be deemed a license grant by ST for the use of such third party products or services, or any intellectual property contained therein or considered as a warranty covering the use in any manner whatsoever of such third party products or services or any intellectual property contained therein.

UNLESS OTHERWISE SET FORTH IN ST'S TERMS AND CONDITIONS OF SALE ST DISCLAIMS ANY EXPRESS OR IMPLIED WARRANTY WITH RESPECT TO THE USE AND/OR SALE OF ST PRODUCTS INCLUDING WITHOUT LIMITATION IMPLIED WARRANTIES OF MERCHANTABILITY, FITNESS FOR A PARTICULAR PURPOSE (AND THEIR EQUIVALENTS UNDER THE LAWS OF ANY JURISDICTION), OR INFRINGEMENT OF ANY PATENT, COPYRIGHT OR OTHER INTELLECTUAL PROPERTY RIGHT.

UNLESS EXPRESSLY APPROVED IN WRITING BY AN AUTHORIZED ST REPRESENTATIVE, ST PRODUCTS ARE NOT RECOMMENDED, AUTHORIZED OR WARRANTED FOR USE IN MILITARY, AIR CRAFT, SPACE, LIFE SAVING, OR LIFE SUSTAINING APPLICATIONS, NOR IN PRODUCTS OR SYSTEMS WHERE FAILURE OR MALFUNCTION MAY RESULT IN PERSONAL INJURY, DEATH, OR SEVERE PROPERTY OR ENVIRONMENTAL DAMAGE. ST PRODUCTS WHICH ARE NOT SPECIFIED AS "AUTOMOTIVE GRADE" MAY ONLY BE USED IN AUTOMOTIVE APPLICATIONS AT USER'S OWN RISK.

Resale of ST products with provisions different from the statements and/or technical features set forth in this document shall immediately void any warranty granted by ST for the ST product or service described herein and shall not create or extend in any manner whatsoever, any liability of ST.

ST and the ST logo are trademarks or registered trademarks of ST in various countries.

Information in this document supersedes and replaces all information previously supplied.

The ST logo is a registered trademark of STMicroelectronics. All other names are the property of their respective owners.

© 2008 STMicroelectronics - All rights reserved

STMicroelectronics group of companies

Australia - Belgium - Brazil - Canada - China - Czech Republic - Finland - France - Germany - Hong Kong - India - Israel - Italy - Japan - Malaysia - Malta - Morocco - Singapore - Spain - Sweden - Switzerland - United Kingdom - United States of America

www.st.com