



4 dB Fixed Attenuator, N Male to N Female Black Anodized Aluminum Heatsink Body Rated to 5 Watts Up to 6 GHz

RF Fixed Attenuators Technical Data Sheet

PE7AP006-04

Features

- DC to 6 GHz Frequency Range
- Attenuation 4±0.75 dB
- Max Power 5 Watts (CW)
- VSWR < 1.25:1

Applications

- Instrumentation
- Precision measurements
- Prototyping and characterization
- Production systems

Description

Pasternack carries a wide range of fixed attenuators with a broad selection of attenuation levels, frequency ranges, and power dissipation ranges. RF microwave attenuators (also known as RF pads) lower the amplitude of a signal (attenuate) a known amount and can be used in a wide variety of applications. These attenuator pads are used when a signal needs to be reduced to protect measurement equipment or other circuitry, to extend the range of power meters and amplifiers, and to impedance match circuits by reducing the VSWR seen by adjacent components. RF attenuators can prevent signal overload in amplifiers, receivers and detectors, adjusting the signal level to a range that is optimal.

Few RF components are as commonly used as fixed coaxial attenuators, and Pasternack carries one of the largest in-stock varieties and ships them same day. The 4 dB Fixed Attenuator PE7AP006-04 is rated to 5 Watts and operates from DC to 6 GHz. The versatile coaxial package uses type N male to type N female connectors and is also REACH and RoHS compliant. The Black Anodized Aluminum Heatsink body allows for efficient heat dissipation under high power usage conditions.

Electrical Specifications

Description	Minimum	Typical	Maximum	Units
Frequency Range	DC		6	GHz
Impedance		50		Ohms
Nominal Attenuation		4		dB
Attenuation Accuracy		0.75		dB
VSWR			1.25:1	
Input Power, CW derated linearly to 0.5W at +125°C			5	Watts
Input Power, Peak 5µs pulse, 0.25% duty cycle			500	Watts

Click the following link (or enter part number in "SEARCH" on website) to obtain additional part information including price, inventory and certifications: [4 dB Fixed Attenuator, N Male to N Female Black Anodized Aluminum Heatsink Body Rated to 5 Watts Up to 6 GHz PE7AP006-04](#)



4 dB Fixed Attenuator, N Male to N Female Black Anodized Aluminum Heatsink Body Rated to 5 Watts Up to 6 GHz

RF Fixed Attenuators Technical Data Sheet

PE7AP006-04

Mechanical Specifications

Size

Length	2.15 in [54.61 mm]
Width/Diameter	0.86 in [21.84 mm]
Weight	0.137 lbs [62.14 g]
Body Material and Plating	Black Anodized Aluminum Heatsink

Configuration

Design	Fixed
Package Style	Connectorized Module

Connectors

Description	Connector 1	Connector 2
Type	N Male	N Female
Contact Material and Plating	Beryllium Copper, Gold	Beryllium Copper, Gold
Contact Plating Specification	MIL-PRF-39012	MIL-PRF-39012
Dielectric Type	Teflon	Teflon
Body Material and Plating	Passivated Stainless Steel	Passivated Stainless Steel

Mechanical Specification Notes:
 Materials and finishes comply with MIL-DTL-3933 and MIL-PRF-39012.

Environmental Specifications

Temperature

Operating Range	-65 to +125 deg C
-----------------	-------------------

Environmental Specification Notes:
 Designed to meet environmental requirements of MIL-DTL-3933.

Compliance Certifications (see [product page](#) for current document)

Plotted and Other Data

Notes:

4 dB Fixed Attenuator, N Male to N Female Black Anodized Aluminum Heatsink Body Rated to 5 Watts Up to 6 GHz from Pasternack Enterprises has same day shipment for domestic and International orders. Our RF, microwave and millimeter wave products maintain a 99.4% availability and are part of the broadest selection in the industry.

Click the following link (or enter part number in "SEARCH" on website) to obtain additional part information including price, inventory and certifications: [4 dB Fixed Attenuator, N Male to N Female Black Anodized Aluminum Heatsink Body Rated to 5 Watts Up to 6 GHz PE7AP006-04](#)

URL: <https://www.pasternack.com/4db-fixed-n-male-n-female-5-watts-attenuator-pe7ap006-04-p.aspx>

PE7AP006-04 CAD Drawing

4 dB Fixed Attenuator, N Male to N Female Black Anodized Aluminum Heatsink Body Rated to 5 Watts Up to 6 GHz

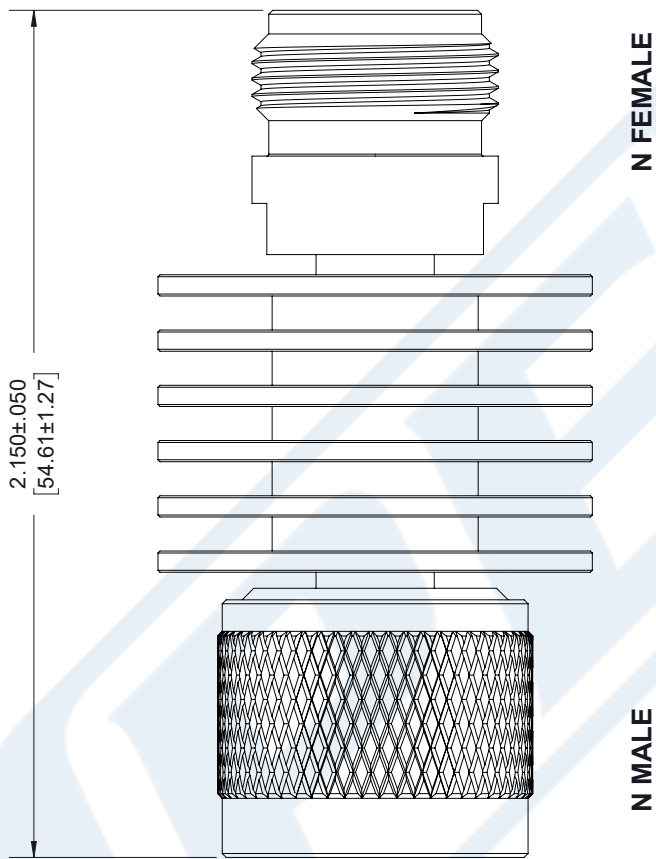
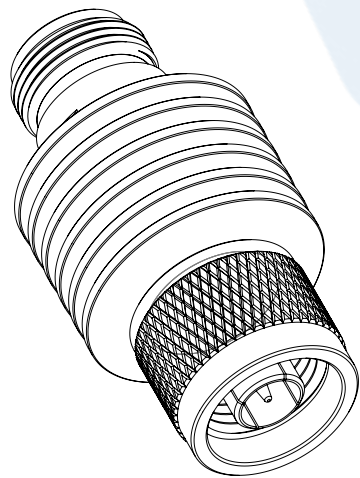

LABEL



STANDARD TOLERANCES

.X	±0.2
.XX	±0.01
.XXX	±0.005

*STANDARD TOLERANCES APPLY ONLY TO DIMENSIONS IN INCHES



Pasternack Enterprises, Inc.
P.O. Box 16759 | Irvine | CA | 92623

Phone: (949) 261-1920 | Fax: (949) 261-7451
Website: www.pasternack.com | E-Mail: sales@pasternack.com

DWG TITLE

PE7AP006-04

NOTES:
1. UNLESS OTHERWISE SPECIFIED ALL DIMENSIONS ARE NOMINAL.
2. ALL SPECIFICATIONS ARE SUBJECT TO CHANGE WITHOUT NOTICE AT ANY TIME.
3. DIMENSIONS ARE IN INCHES [mm].

CAGE CODE 53919

CAD FILE 07/31/18

SCALE N/A

SIZE A

7361