



# Ultra-Low-Power Precision Series Voltage Reference

MAX6029

## General Description

The MAX6029 micropower, low-dropout bandgap voltage reference combines ultra-low supply current and low drift in a miniature 5-pin SOT23 surface-mount package that uses 70% less board space than comparable devices in an SO package. An initial accuracy of 0.15% and a 30ppm/°C (max) temperature coefficient make the MAX6029 suitable for precision applications. This series-mode voltage reference sources up to 4mA and sinks up to 1mA of load current. A wide 2.5V to 12.6V supply range, ultra-low 5.25µA (max) supply current, and a low 200mV dropout voltage make these devices ideal for battery-operated systems. Additionally, an internal compensation capacitor eliminates the need for an external compensation capacitor and ensures stability with load capacitances up to 10µF.

The MAX6029 provides six output voltages of 2.048V, 2.5V, 3V, 3.3V, 4.096V, and 5V. The MAX6029 is available in a 5-pin SOT23 or an 8-pin SO package and is specified over the extended temperature range (-40°C to +85°C).

## Applications

- Battery-Powered Systems
- Hand-Held Instruments
- Precision Power Supplies
- A/D and D/A Converters

## Pin Configurations

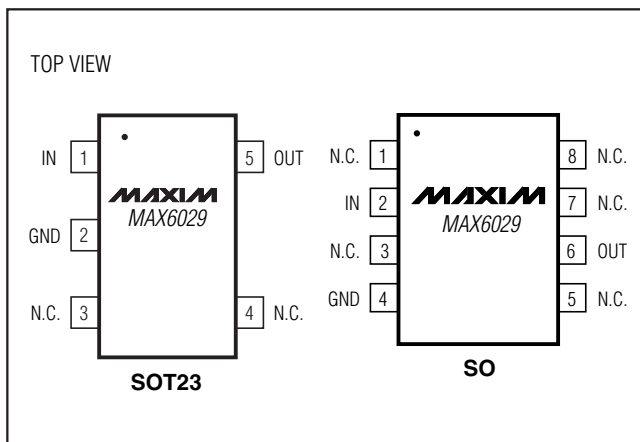

## Features

- ◆ Ultra-Low 5.25µA (max) Supply Current
- ◆ ±0.15% (max) Initial Accuracy
- ◆ 30ppm/°C (max) Temperature Coefficient
- ◆ 4mA Output Source Current
- ◆ 1mA Output Sink Current
- ◆ 2.5V to 12.6V Supply Range
- ◆ Low 200mV Dropout
- ◆ Stable with Capacitive Loads Up to 10µF
- ◆ No External Capacitors Required
- ◆ Miniature 5-Pin SOT23 Package, 8-Pin SO Package

## Ordering Information

PART	PIN-PACKAGE	TOP MARK	PKG CODE
MAX6029EUK21-T	5 SOT23-5	AEHD	U5-1
MAX6029EUK25-T	5 SOT23-5	AEHF	U5-1
MAX6029ESA25	8 SO	—	S8-2
MAX6029EUK30-T	5 SOT23-5	AEHH	U5-1
MAX6029EUK33-T	5 SOT23-5	AEHN	U5-1
MAX6029EUK41-T	5 SOT23-5	AEHJ	U5-1
MAX6029ESA41	8 SO	—	S8-2
MAX6029EUK50-T	5 SOT23-5	AEHL	U5-1

**Note:** All devices are specified over the -40°C to +85°C operating temperature range.

## Selector Guide

PART	PIN-PACKAGE	OUTPUT VOLTAGE (V)
MAX6029EUK21-T	5 SOT23-5	2.048
MAX6029EUK25-T	5 SOT23-5	2.500
MAX6029ESA25	8 SO	2.500
MAX6029EUK30-T	5 SOT23-5	3.000
MAX6029EUK33-T	5 SOT23-5	3.300
MAX6029EUK41-T	5 SOT23-5	4.096
MAX6029ESA41	8 SO	4.096
MAX6029EUK50-T	5 SOT23-5	5.000



**For pricing, delivery, and ordering information, please contact Maxim/Dallas Direct! at 1-888-629-4642, or visit Maxim's website at [www.maxim-ic.com](http://www.maxim-ic.com).**

# Ultra-Low-Power Precision Series Voltage Reference

## ABSOLUTE MAXIMUM RATINGS

IN to GND .....-0.3V to +13V  
 OUT to GND .....-0.3V to the lower of +6V and ( $V_{IN} + 0.3V$ )  
 Output to GND Short-Circuit Duration.....Continuous  
 Continuous Power Dissipation ( $T_A = +70^\circ\text{C}$ )  
   5-Pin SOT23 (derate 7.1mW/ $^\circ\text{C}$  above  $+70^\circ\text{C}$ ).....571mW  
   8-Pin SO (derate 5.9mW/ $^\circ\text{C}$  above  $+70^\circ\text{C}$ ).....470.6mW

Operating Temperature Range .....-40 $^\circ\text{C}$  to +85 $^\circ\text{C}$   
 Storage Temperature Range .....-65 $^\circ\text{C}$  to +150 $^\circ\text{C}$   
 Lead Temperature (soldering, 10s) .....+300 $^\circ\text{C}$

Stresses beyond those listed under "Absolute Maximum Ratings" may cause permanent damage to the device. These are stress ratings only, and functional operation of the device at these or any other conditions beyond those indicated in the operational sections of the specifications is not implied. Exposure to absolute maximum rating conditions for extended periods may affect device reliability.

## ELECTRICAL CHARACTERISTICS—MAX6029\_21 ( $V_{OUT} = 2.048V$ )

( $V_{IN} = 2.5V$ ,  $I_{OUT} = 0$ ,  $T_A = T_{MIN}$  to  $T_{MAX}$ , unless otherwise noted. Typical values are at  $T_A = +25^\circ\text{C}$ .) (Note 1)

PARAMETER	SYMBOL	CONDITIONS	MIN	TYP	MAX	UNITS
<b>OUTPUT</b>						
Output Voltage	$V_{OUT}$	$T_A = +25^\circ\text{C}$	2.0449	2.0480	2.0511	V
Output Voltage Temperature Coefficient	$TCV_{OUT}$	(Notes 2, 3)			30	ppm/ $^\circ\text{C}$
Line Regulation	$\Delta V_{OUT}/\Delta V_{IN}$	$V_{IN} = 2.5V$ to 12.6V		27	200	$\mu\text{V}/V$
Load Regulation	$\Delta V_{OUT}/\Delta I_{OUT}$	$I_{OUT} = 0$ to 4mA		0.22	0.7	$\mu\text{V}/\mu\text{A}$
		$I_{OUT} = 0$ to -1mA		2.4	5.5	
Output Short-Circuit Current	$I_{SC}$			60		mA
Long-Term Stability	$\Delta V_{OUT}/\text{time}$	1000 hours at $+25^\circ\text{C}$		150		ppm
Thermal Hysteresis		(Note 4)		140		ppm
<b>DYNAMIC CHARACTERISTICS</b>						
Noise Voltage	$e_{OUT}$	f = 0.1Hz to 10Hz		30		$\mu\text{V}_{P-P}$
		f = 10Hz to 1kHz		115		$\mu\text{V}_{RMS}$
Ripple Rejection	$\Delta V_{OUT}/\Delta V_{IN}$	$V_{IN} = 2.5V \pm 200\text{mV}$ , f = 120Hz		43		dB
Turn-On Settling Time	$t_R$	To $V_{OUT} = 0.1\%$ of final value		450		$\mu\text{s}$
<b>INPUT</b>						
Supply Voltage Range	$V_{IN}$		2.5		12.6	V
Supply Current	$I_{IN}$				5.25	$\mu\text{A}$
Change in Supply Current	$I_{IN}/V_{IN}$	$V_{IN} = 2.5V$ to 12.6V			1.5	$\mu\text{A}/V$

# Ultra-Low-Power Precision Series Voltage Reference

**MAX6029**

## ELECTRICAL CHARACTERISTICS—MAX6029\_25 (V<sub>OUT</sub> = 2.500V)

(V<sub>IN</sub> = 2.7V, I<sub>OUT</sub> = 0, T<sub>A</sub> = T<sub>MIN</sub> to T<sub>MAX</sub>, unless otherwise noted. Typical values are at T<sub>A</sub> = +25°C.) (Note 1)

PARAMETER	SYMBOL	CONDITIONS	MIN	TYP	MAX	UNITS	
<b>OUTPUT</b>							
Output Voltage	V <sub>OUT</sub>	T <sub>A</sub> = +25°C	MAX6029EUK	2.4963	2.5000	2.5038	V
			MAX6029ESA	2.495	2.500	2.505	
Output Voltage Temperature Coefficient	TCV <sub>OUT</sub>	(Notes 2, 3)			30	ppm/°C	
Line Regulation	ΔV <sub>OUT</sub> /ΔV <sub>IN</sub>	V <sub>IN</sub> = 2.7V to 12.6V		30	230	μV/V	
Load Regulation	ΔV <sub>OUT</sub> /ΔI <sub>OUT</sub>	I <sub>OUT</sub> = 0 to 4mA		0.1	0.6	μV/μA	
		I <sub>OUT</sub> = 0 to -1mA		2.5	6.2		
Dropout Voltage (Note 5)	V <sub>IN</sub> - V <sub>OUT</sub>	I <sub>OUT</sub> = 0			100	mV	
		I <sub>OUT</sub> = 4mA			200		
Output Short-Circuit Current	I <sub>SC</sub>			60		mA	
Long-Term Stability	ΔV <sub>OUT</sub> /time	1000 hours at +25°C		150		ppm	
Thermal Hysteresis		(Note 4)		140		ppm	
<b>DYNAMIC CHARACTERISTICS</b>							
Noise Voltage	e <sub>OUT</sub>	f = 0.1Hz to 10Hz		39		μV <sub>P-P</sub>	
		f = 10Hz to 1kHz		137		μV <sub>RMS</sub>	
Ripple Rejection	ΔV <sub>OUT</sub> /ΔV <sub>IN</sub>	V <sub>IN</sub> = 2.7V ±200mV, f = 120Hz		34		dB	
Turn-On Settling Time	t <sub>R</sub>	To V <sub>OUT</sub> = 0.1% of final value		700		ms	
<b>INPUT</b>							
Supply Voltage Range	V <sub>IN</sub>		2.7		12.6	V	
Supply Current	I <sub>IN</sub>				5.75	μA	
Change in Supply Current	I <sub>IN</sub> /V <sub>IN</sub>	V <sub>IN</sub> = 2.7V to 12.6V			1.5	μA/V	

# Ultra-Low-Power Precision Series Voltage Reference

## ELECTRICAL CHARACTERISTICS—MAX6029\_30 (V<sub>OUT</sub> = 3.000V)

(V<sub>IN</sub> = 3.2V, I<sub>OUT</sub> = 0, T<sub>A</sub> = T<sub>MIN</sub> to T<sub>MAX</sub>, unless otherwise noted. Typical values are at T<sub>A</sub> = +25°C.) (Note 1)

PARAMETER	SYMBOL	CONDITIONS	MIN	TYP	MAX	UNITS
<b>OUTPUT</b>						
Output Voltage	V <sub>OUT</sub>	T <sub>A</sub> = +25°C	2.9955	3.0000	3.0045	V
Output Voltage Temperature Coefficient	TCV <sub>OUT</sub>	(Notes 2, 3)			30	ppm/°C
Line Regulation	ΔV <sub>OUT</sub> /ΔV <sub>IN</sub>	V <sub>IN</sub> = 3.2V to 12.6V		15	250	μV/V
Load Regulation	ΔV <sub>OUT</sub> /ΔI <sub>OUT</sub>	I <sub>OUT</sub> = 0 to 4mA		0.1	0.6	μV/μA
		I <sub>OUT</sub> = 0 to -1mA		2.4	6.5	
Dropout Voltage (Note 5)	V <sub>IN</sub> - V <sub>OUT</sub>	I <sub>OUT</sub> = 0			100	mV
		I <sub>OUT</sub> = 4mA			200	
Output Short-Circuit Current	I <sub>SC</sub>			60		mA
Long-Term Stability	ΔV <sub>OUT</sub> /time	1000 hours at +25°C		150		ppm
Thermal Hysteresis		(Note 4)		140		ppm
<b>DYNAMIC CHARACTERISTICS</b>						
Noise Voltage	e <sub>OUT</sub>	f = 0.1Hz to 10Hz		39		μV <sub>P-P</sub>
		f = 10Hz to 1kHz		161		μV <sub>RMS</sub>
Ripple Rejection	ΔV <sub>OUT</sub> /ΔV <sub>IN</sub>	V <sub>IN</sub> = 3.2V ±200mV, f = 120Hz		37		dB
Turn-On Settling Time	t <sub>R</sub>	To V <sub>OUT</sub> = 0.1% of final value		775		μs
<b>INPUT</b>						
Supply Voltage Range	V <sub>IN</sub>		3.2		12.6	V
Supply Current	I <sub>IN</sub>				6.75	μA
Change in Supply Current	I <sub>IN</sub> /V <sub>IN</sub>	V <sub>IN</sub> = 3.2V to 12.6V			1.5	μA/V

# Ultra-Low-Power Precision Series Voltage Reference

**MAX6029**

## ELECTRICAL CHARACTERISTICS—MAX6029\_33 (V<sub>OUT</sub> = 3.300V)

(V<sub>IN</sub> = 3.5V, I<sub>OUT</sub> = 0, T<sub>A</sub> = T<sub>MIN</sub> to T<sub>MAX</sub>, unless otherwise noted. Typical values are at T<sub>A</sub> = +25°C.) (Note 1)

PARAMETER	SYMBOL	CONDITIONS	MIN	TYP	MAX	UNITS
<b>OUTPUT</b>						
Output Voltage	V <sub>OUT</sub>	T <sub>A</sub> = +25°C	3.2951	3.3000	3.3050	V
Output Voltage Temperature Coefficient	TCV <sub>OUT</sub>	(Notes 2, 3)			30	ppm/°C
Line Regulation	ΔV <sub>OUT</sub> /ΔV <sub>IN</sub>	V <sub>IN</sub> = 3.5V to 12.6V		30	270	μV/V
Load Regulation	ΔV <sub>OUT</sub> /ΔI <sub>OUT</sub>	I <sub>OUT</sub> = 0 to 4mA		0.1	0.6	μV/μA
		I <sub>OUT</sub> = 0 to -1mA		2.4	7	
Dropout Voltage (Note 5)	V <sub>IN</sub> - V <sub>OUT</sub>	I <sub>OUT</sub> = 0			100	mV
		I <sub>OUT</sub> = 4mA			200	
Output Short-Circuit Current	I <sub>SC</sub>			60		mA
Long-Term Stability	ΔV <sub>OUT</sub> /time	1000 hours at +25°C		150		ppm
Thermal Hysteresis		(Note 4)		140		ppm
<b>DYNAMIC CHARACTERISTICS</b>						
Noise Voltage	e <sub>OUT</sub>	f = 0.1Hz to 10Hz		56		μV <sub>P-P</sub>
		f = 10Hz to 1kHz		174		μV <sub>RMS</sub>
Ripple Rejection	ΔV <sub>OUT</sub> /ΔV <sub>IN</sub>	V <sub>IN</sub> = 3.5V ±200mV, f = 120Hz		38		dB
Turn-On Settling Time	t <sub>R</sub>	T <sub>o</sub> V <sub>OUT</sub> = 0.1% of final value		1		ms
<b>INPUT</b>						
Supply Voltage Range	V <sub>IN</sub>		3.5		12.6	V
Supply Current	I <sub>IN</sub>				7.25	μA
Change in Supply Current	I <sub>IN</sub> /V <sub>IN</sub>	V <sub>IN</sub> = 3.5V to 12.6V			1.5	μA/V

# Ultra-Low-Power Precision Series Voltage Reference

**MAX6029**

## ELECTRICAL CHARACTERISTICS—MAX6029\_41 (V<sub>OUT</sub> = 4.096V)

(V<sub>IN</sub> = 4.3V, I<sub>OUT</sub> = 0, T<sub>A</sub> = T<sub>MIN</sub> to T<sub>MAX</sub>, unless otherwise noted. Typical values are at T<sub>A</sub> = +25°C.) (Note 1)

PARAMETER	SYMBOL	CONDITIONS	MIN	TYP	MAX	UNITS	
<b>OUTPUT</b>							
Output Voltage	V <sub>OUT</sub>	T <sub>A</sub> = +25°C	MAX6029EUK	4.0899	4.0960	4.1021	V
			MAX6029ESA	4.088	4.096	4.104	
Output Voltage Temperature Coefficient	TCV <sub>OUT</sub>	(Notes 2, 3)			30	ppm/°C	
Line Regulation	ΔV <sub>OUT</sub> /ΔV <sub>IN</sub>	V <sub>IN</sub> = 4.3V to 12.6V		30	310	μV/V	
Load Regulation	ΔV <sub>OUT</sub> /ΔI <sub>OUT</sub>	I <sub>OUT</sub> = 0 to 4mA		0.1	0.6	μV/μA	
		I <sub>OUT</sub> = 0 to -1mA		2.5	8.5		
Dropout Voltage (Note 5)	V <sub>IN</sub> - V <sub>OUT</sub>	I <sub>OUT</sub> = 0			100	mV	
		I <sub>OUT</sub> = 4mA			200		
Output Short-Circuit Current	I <sub>SC</sub>			60		mA	
Long-Term Stability	ΔV <sub>OUT</sub> /time	1000 hours at +25°C		150		ppm	
Thermal Hysteresis		(Note 4)		140		ppm	
<b>DYNAMIC CHARACTERISTICS</b>							
Noise Voltage	e <sub>OUT</sub>	f = 0.1Hz to 10Hz		72		μV <sub>P-P</sub>	
		f = 10Hz to 1kHz		210		μV <sub>RMS</sub>	
Ripple Rejection	ΔV <sub>OUT</sub> /ΔV <sub>IN</sub>	V <sub>IN</sub> = 4.3V ±200mV, f = 120Hz		36		dB	
Turn-On Settling Time	t <sub>R</sub>	To V <sub>OUT</sub> = 0.1% of final value		1.2		ms	
<b>INPUT</b>							
Supply Voltage Range	V <sub>IN</sub>		4.3		12.6	V	
Supply Current	I <sub>IN</sub>				8.75	μA	
Change in Supply Current	I <sub>IN</sub> /V <sub>IN</sub>	V <sub>IN</sub> = 4.3V to 12.6V			1.5	μA/V	

# Ultra-Low-Power Precision Series Voltage Reference

**MAX6029**

## ELECTRICAL CHARACTERISTICS—MAX6029\_50 (V<sub>OUT</sub> = 5.000V)

(V<sub>IN</sub> = 5.2V, I<sub>OUT</sub> = 0, T<sub>A</sub> = T<sub>MIN</sub> to T<sub>MAX</sub>, unless otherwise noted. Typical values are at T<sub>A</sub> = +25°C.) (Note 1)

PARAMETER	SYMBOL	CONDITIONS	MIN	TYP	MAX	UNITS
<b>OUTPUT</b>						
Output Voltage	V <sub>OUT</sub>	T <sub>A</sub> = +25°C	4.9925	5.0000	5.0075	V
Output Voltage Temperature Coefficient	TCV <sub>OUT</sub>	(Notes 2, 3)			30	ppm/°C
Line Regulation	ΔV <sub>OUT</sub> /ΔV <sub>IN</sub>	V <sub>IN</sub> = 5.2V to 12.6V		34	375	μV/V
Load Regulation	ΔV <sub>OUT</sub> /ΔI <sub>OUT</sub>	I <sub>OUT</sub> = 0 to 4mA		0.3	0.8	μV/μA
		I <sub>OUT</sub> = 0 to -1mA		3.3	9	
Dropout Voltage (Note 5)	V <sub>IN</sub> - V <sub>OUT</sub>	I <sub>OUT</sub> = 0			100	mV
		I <sub>OUT</sub> = 4mA			200	
Output Short-Circuit Current	I <sub>SC</sub>			60		mA
Long-Term Stability	ΔV <sub>OUT</sub> /time	1000 hours at +25°C		150		ppm
Thermal Hysteresis		(Note 4)		140		ppm
<b>DYNAMIC CHARACTERISTICS</b>						
Noise Voltage	e <sub>OUT</sub>	f = 0.1Hz to 10Hz		90		μV <sub>P-P</sub>
		f = 10Hz to 1kHz		245		μV <sub>RMS</sub>
Ripple Rejection	ΔV <sub>OUT</sub> /ΔV <sub>IN</sub>	V <sub>IN</sub> = 5.2V ±200mV, f = 120Hz		38		dB
Turn-On Settling Time	t <sub>R</sub>	To V <sub>OUT</sub> = 0.1% of final value		1.4		ms
<b>INPUT</b>						
Supply Voltage Range	V <sub>IN</sub>		5.2		12.6	V
Supply Current	I <sub>IN</sub>				10.5	μA
Change in Supply Current	I <sub>IN</sub> /V <sub>IN</sub>	V <sub>IN</sub> = 5.2V to 12.6V			1.5	μA/V

**Note 1:** MAX6029 is 100% production tested at T<sub>A</sub> = +25°C and is guaranteed by design for T<sub>A</sub> = T<sub>MIN</sub> to T<sub>MAX</sub> as specified.

**Note 2:** Temperature coefficient is defined by box method: (V<sub>MAX</sub> - V<sub>MIN</sub>)/(ΔT × V<sub>+25°C</sub>).

**Note 3:** Not production tested. Guaranteed by design.

**Note 4:** Thermal hysteresis is defined as the change in T<sub>A</sub> = +25°C output voltage before and after temperature cycling of the device (from T<sub>A</sub> = T<sub>MIN</sub> to T<sub>MAX</sub>). Initial measurement at T<sub>A</sub> = +25°C is followed by temperature cycling the device to T<sub>A</sub> = +85°C then to T<sub>A</sub> = -40°C and another measurement at T<sub>A</sub> = +25°C is compared to the original measurement at T<sub>A</sub> = +25°C.

**Note 5:** Dropout voltage is the minimum input voltage at which V<sub>OUT</sub> changes by 0.1% from V<sub>OUT</sub> at rated V<sub>IN</sub> and is guaranteed by Load Regulation Test.

# Ultra-Low-Power Precision Series Voltage Reference

## Typical Operating Characteristics

( $V_{IN} = 2.5V$  for MAX6029EUK21,  $V_{IN} = 3.2V$  for MAX6029EUK30, and  $V_{IN} = 5.2V$  for MAX6029EUK50,  $I_{OUT} = 0$ ,  $T_A = +25^\circ C$ , unless otherwise noted.)

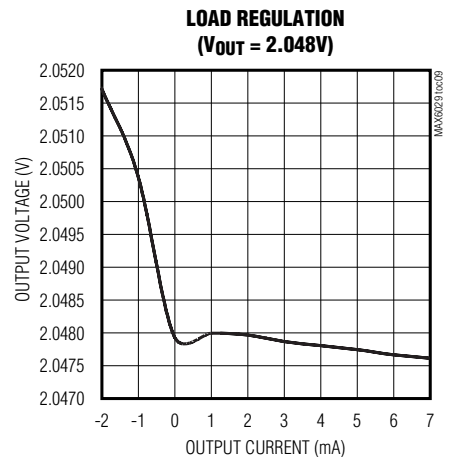
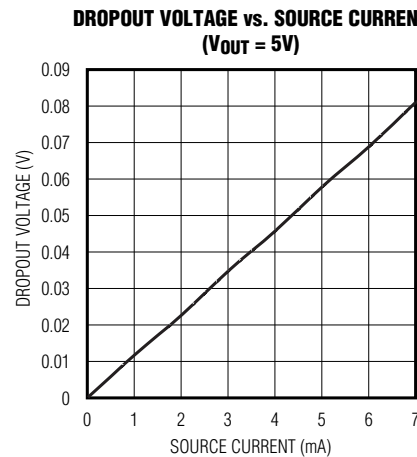
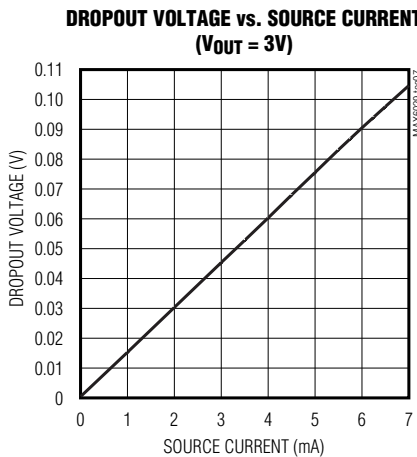
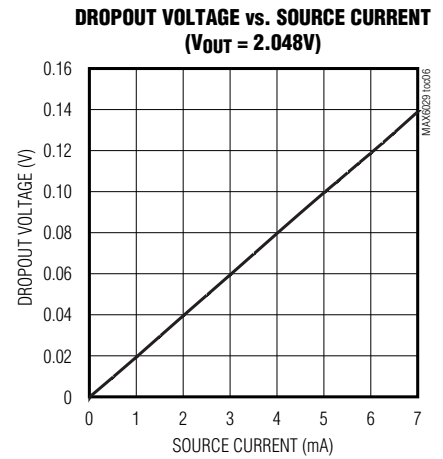
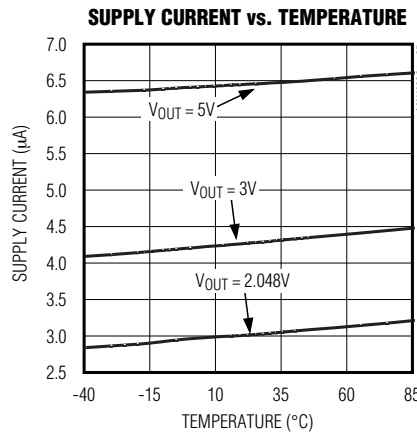
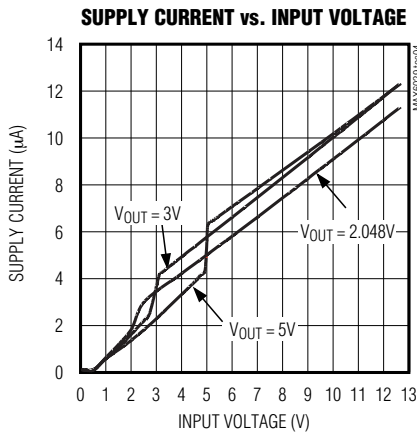
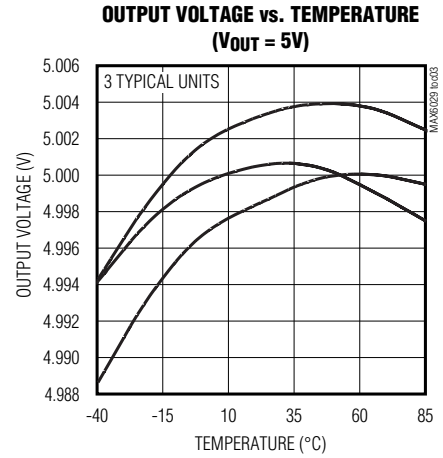
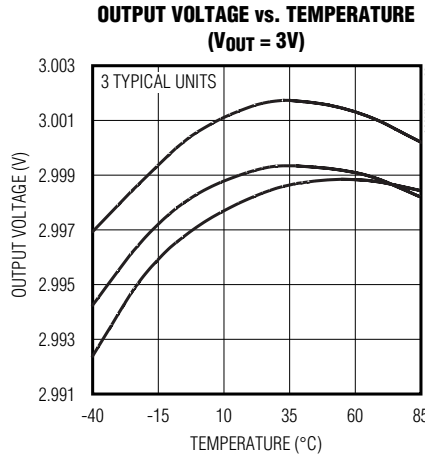
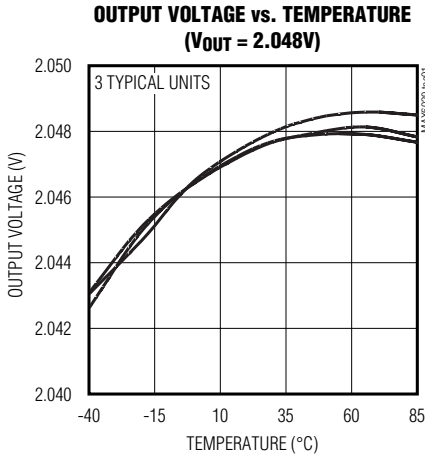



# Ultra-Low-Power Precision Series Voltage Reference

MAX6029

## Typical Operating Characteristics (continued)

( $V_{IN} = 2.5V$  for MAX6029EUK21,  $V_{IN} = 3.2V$  for MAX6029EUK30, and  $V_{IN} = 5.2V$  for MAX6029EUK50,  $I_{OUT} = 0$ ,  $T_A = +25^\circ C$ , unless otherwise noted.)

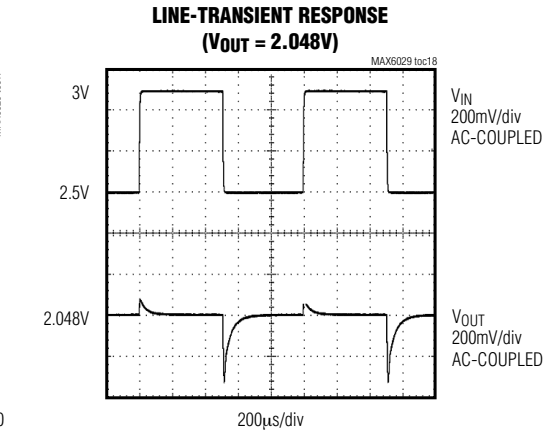
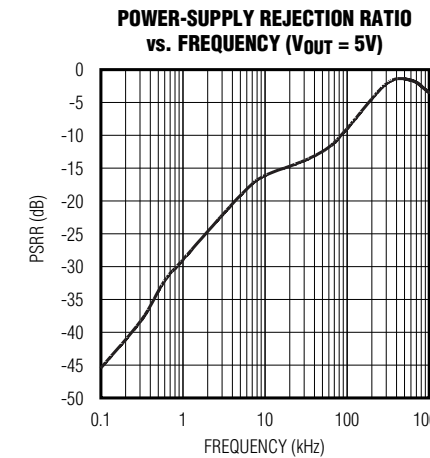
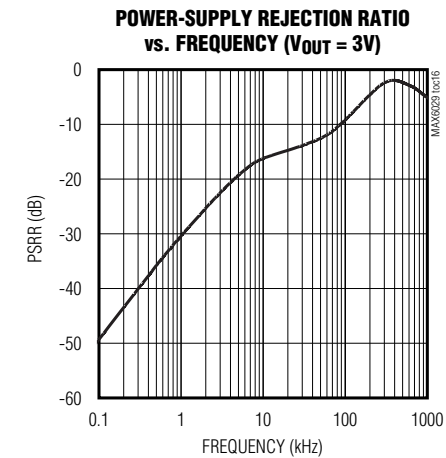
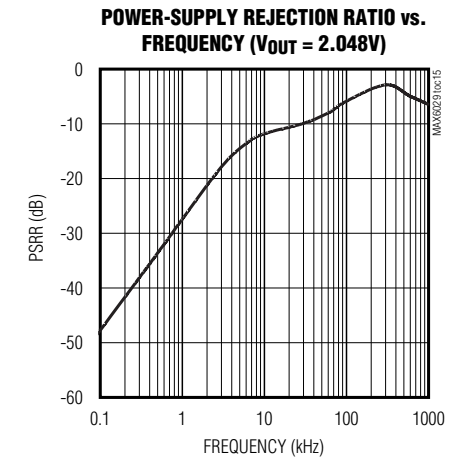
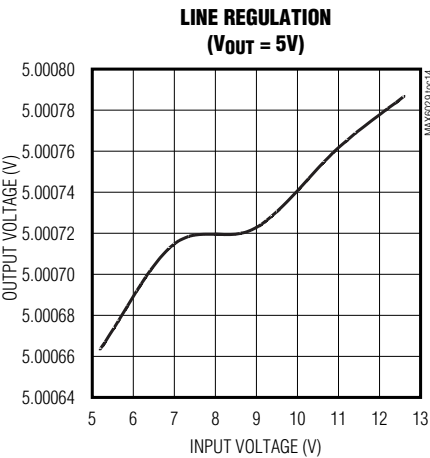
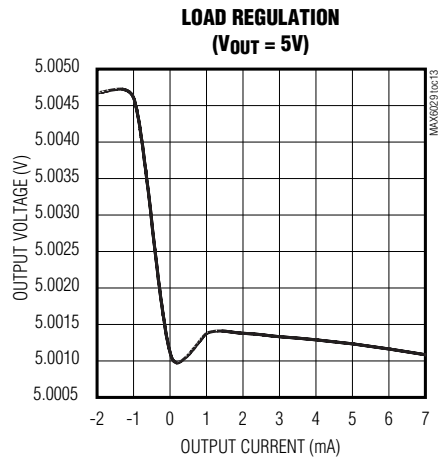
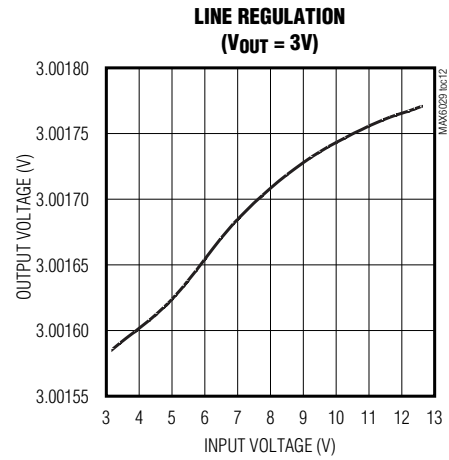
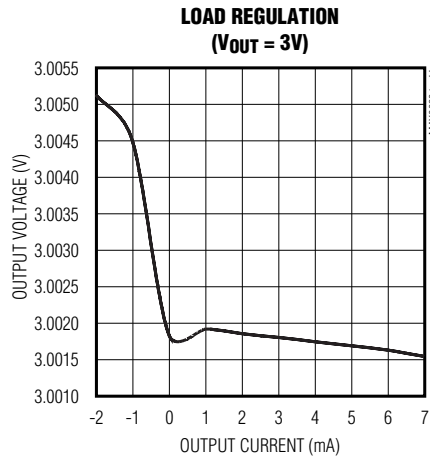
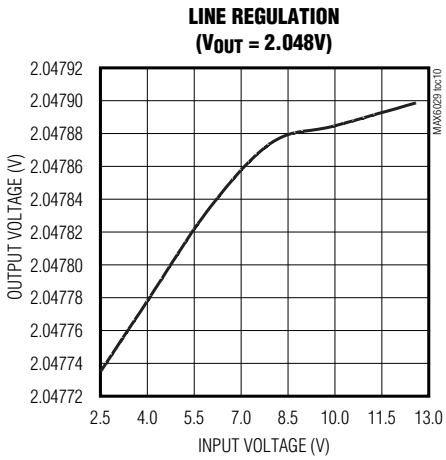

# Ultra-Low-Power Precision Series Voltage Reference

## Typical Operating Characteristics (continued)

( $V_{IN} = 2.5V$  for MAX6029EUK21,  $V_{IN} = 3.2V$  for MAX6029EUK30, and  $V_{IN} = 5.2V$  for MAX6029EUK50,  $I_{OUT} = 0$ ,  $T_A = +25^\circ C$ , unless otherwise noted.)

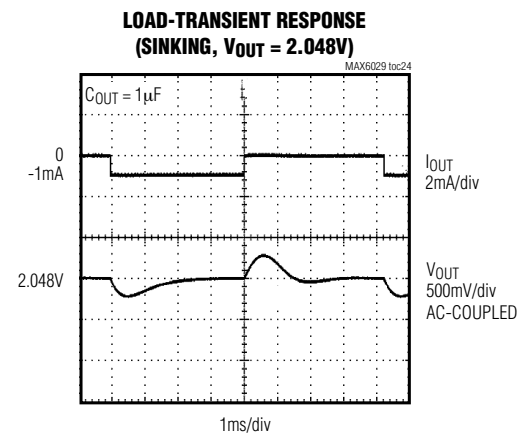
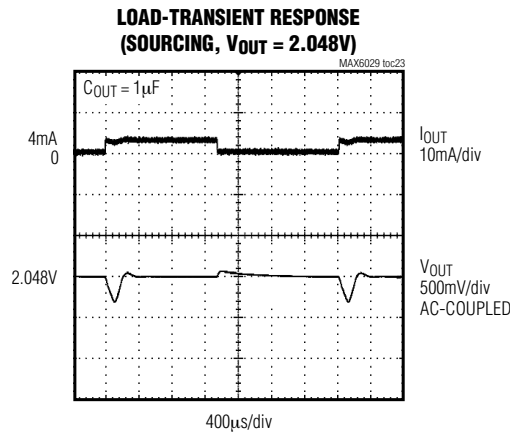
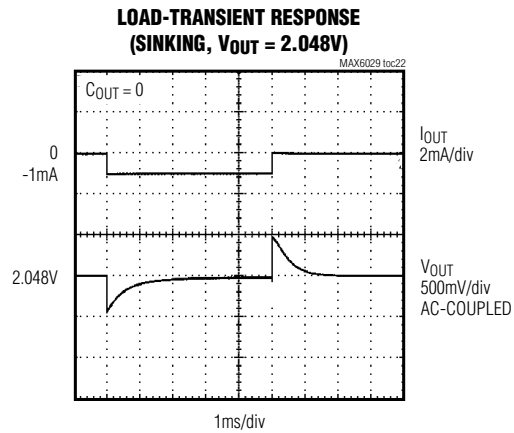
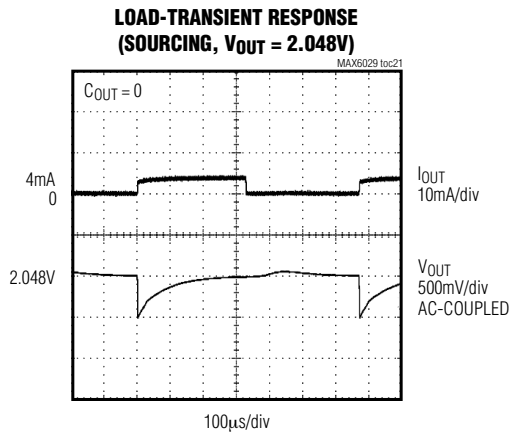
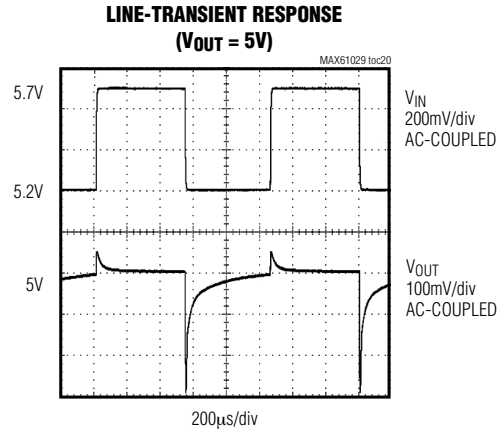
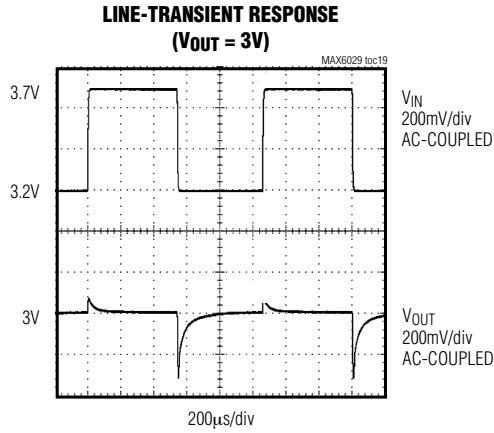

# Ultra-Low-Power Precision Series Voltage Reference

MAX6029

## Typical Operating Characteristics (continued)

( $V_{IN} = 2.5V$  for MAX6029EUK21,  $V_{IN} = 3.2V$  for MAX6029EUK30, and  $V_{IN} = 5.2V$  for MAX6029EUK50,  $I_{OUT} = 0$ ,  $T_A = +25^\circ C$ , unless otherwise noted.)

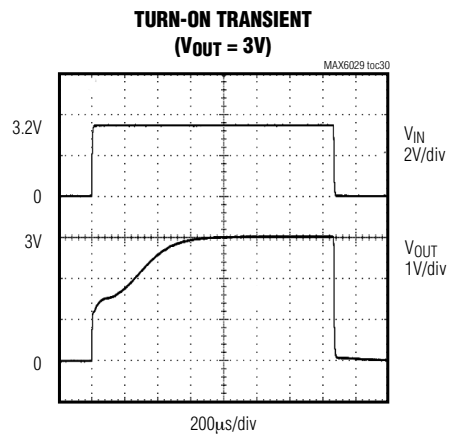
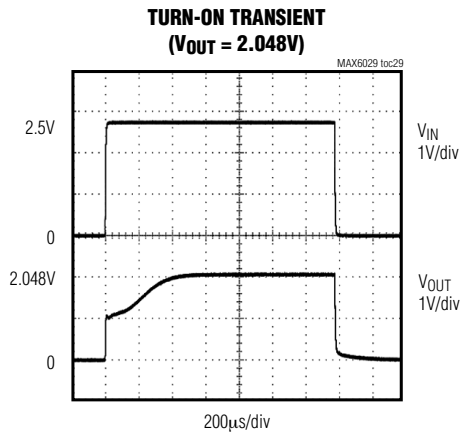
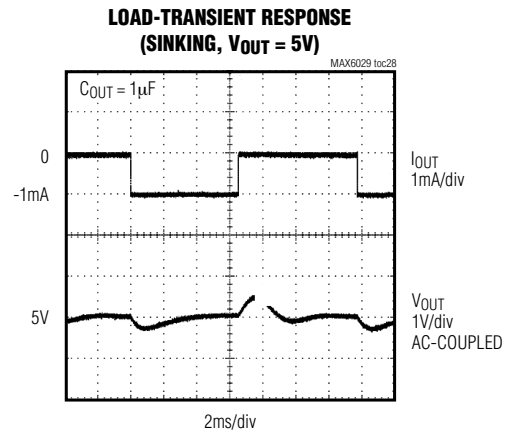
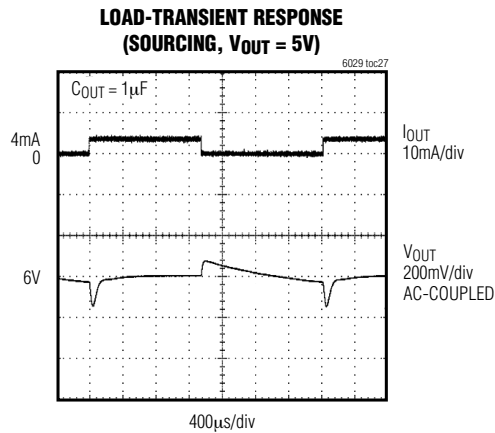
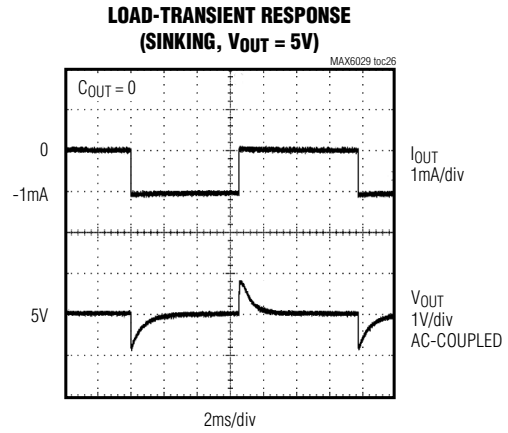
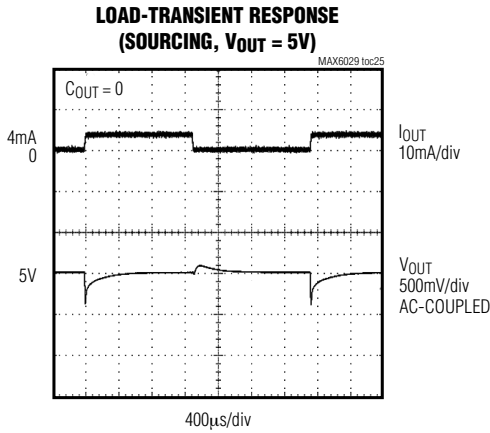

# Ultra-Low-Power Precision Series Voltage Reference

## Typical Operating Characteristics (continued)

( $V_{IN} = 2.5V$  for MAX6029EUK21,  $V_{IN} = 3.2V$  for MAX6029EUK30, and  $V_{IN} = 5.2V$  for MAX6029EUK50,  $I_{OUT} = 0$ ,  $T_A = +25^\circ C$ , unless otherwise noted.)

**TURN-ON TRANSIENT**  
( $V_{OUT} = 5V$ )

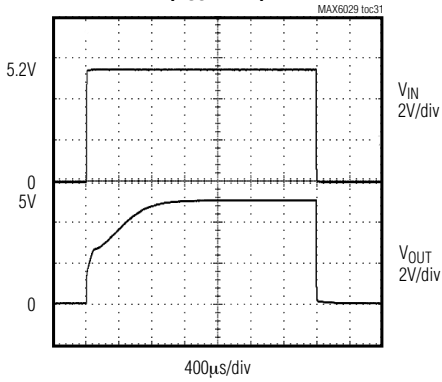

**0.1Hz TO 10Hz OUTPUT NOISE**  
( $V_{OUT} = 2.048V$ )

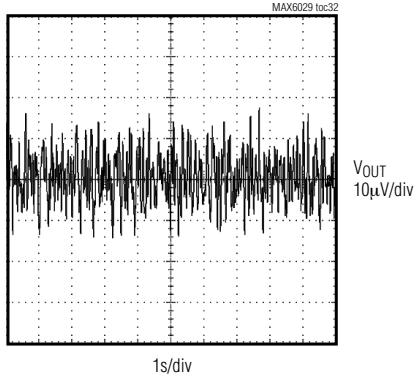

**0.1Hz TO 10Hz OUTPUT NOISE**  
( $V_{OUT} = 3V$ )

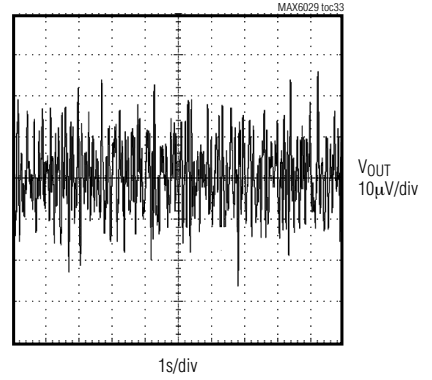

**0.1Hz TO 10Hz OUTPUT NOISE**  
( $V_{OUT} = 5V$ )

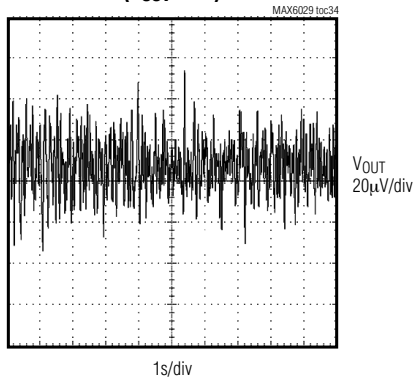

**NOISE vs. FREQUENCY**  
( $V_{OUT} = 2.048V$ )

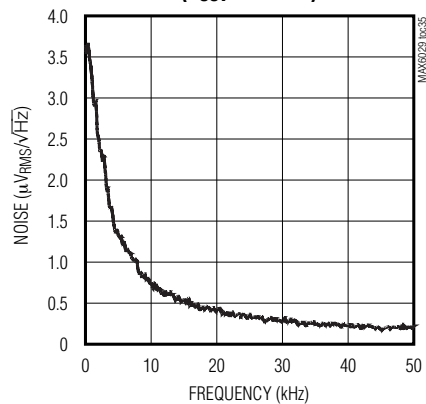

**NOISE vs. FREQUENCY**  
( $V_{OUT} = 3V$ )

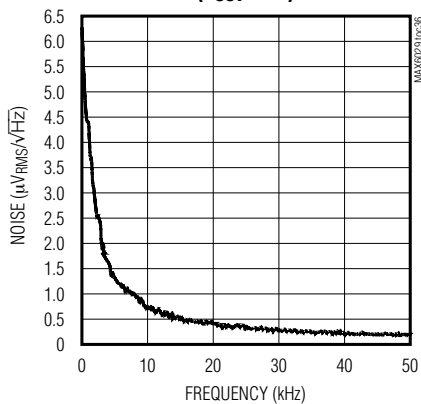

**NOISE vs. FREQUENCY**  
( $V_{OUT} = 5V$ )

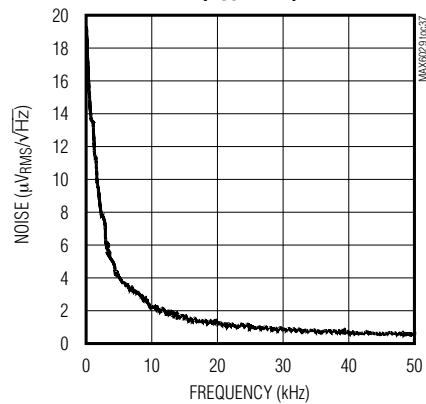

# Ultra-Low-Power Precision Series Voltage Reference

MAX6029

## Pin Description

PIN		NAME	FUNCTION
SOT23	SO		
1	2	IN	Positive Voltage Supply
2	4	GND	Ground
3, 4	1, 3, 5, 7, 8	N.C.	No Connection. Leave unconnected or connect to ground.
5	6	OUT	Reference Output

## Applications Information

### Input Bypassing

The MAX6029 does not require an input bypass capacitor. For improved transient performance, bypass the input to ground with a 0.1 $\mu$ F ceramic capacitor. Place the capacitor as close to IN as possible.

### Load Capacitance

The MAX6029 does not require an output capacitor for stability. The MAX6029 is stable driving capacitive loads from 0 to 100pF and 0.1 $\mu$ F to 10 $\mu$ F when sourcing current and from 0 to 0.4 $\mu$ F when sinking current. In applications where the load or the supply can experience step changes, an output capacitor reduces the amount of overshoot (undershoot) and improves the circuit's transient response. Many applications do not require an external capacitor, and the MAX6029 offers a significant advantage in applications where board space is critical.

### Supply Current

The quiescent supply current of the series-mode MAX6029 is very small, 5.25 $\mu$ A (max), and is very stable against changes in the supply voltage with only

1.5 $\mu$ A/V (max) variation with supply voltage. The MAX6029 family draws load current from the input voltage source only when required, so supply current is not wasted and efficiency is maximized at all input voltages. This improved efficiency reduces power dissipation and extends battery life.

### Output Thermal Hysteresis

Output thermal hysteresis is the change of the output voltage at  $T_A = +25^\circ\text{C}$  before and after the device is cycled over its entire operating temperature range. Hysteresis is caused by differential package stress appearing across the device.

### Temperature Coefficient vs. Operating Temperature Range for a 1LSB Maximum Error

In a data converter application, the reference voltage of the converter must stay within a certain limit to keep the error in the data converter smaller than the resolution limit through the operating temperature range. Figure 1 shows the maximum allowable reference voltage temperature coefficient to keep the conversion error to less than 1 LSB, as a function of the operating temperature range ( $T_{MAX} - T_{MIN}$ ) with the converter resolution as a parameter. The graph assumes the reference-voltage temperature coefficient as the only parameter affecting accuracy.

In reality, the absolute static accuracy of a data converter is dependent on the combination of many parameters such as integral nonlinearity, differential nonlinearity, offset error, gain error, as well as voltage reference changes.

### Turn-On Time

These devices turn on and settle to within 0.1% of their final value in less than 1ms. The turn-on time increases when heavily loaded and operating close to dropout.

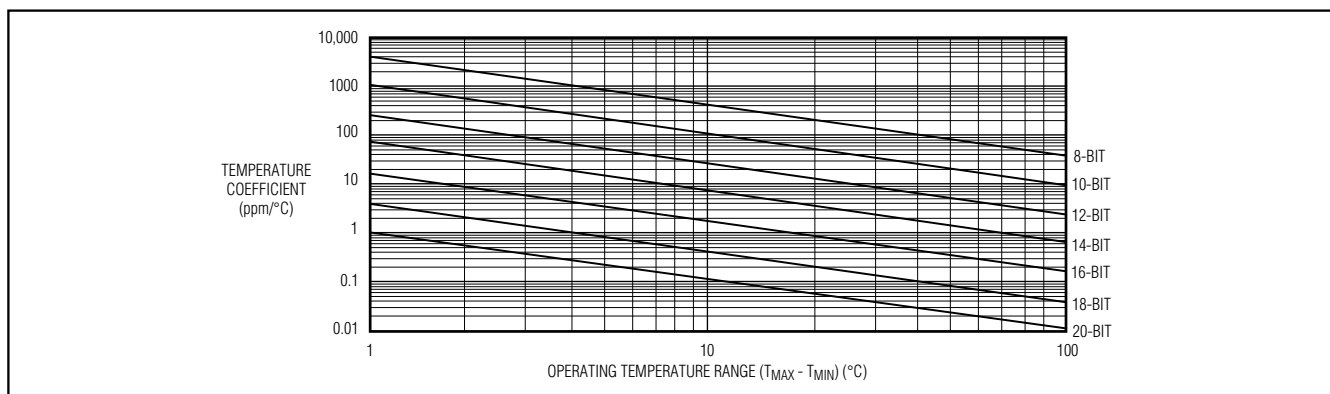
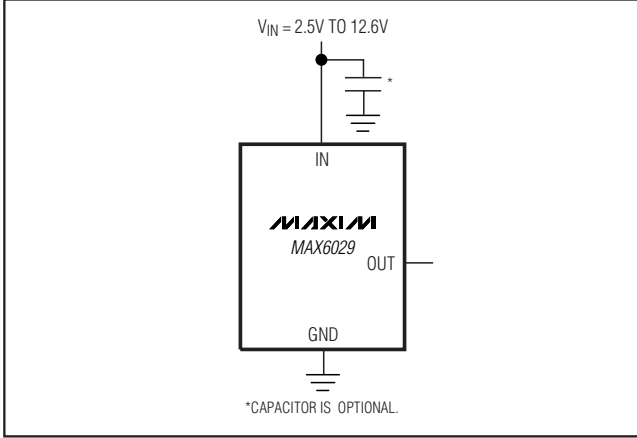

Figure 1. Temperature Coefficient vs. Operating Temperature Range for a 1 LSB Maximum Error

# Ultra-Low-Power Precision Series Voltage Reference

## Typical Operating Circuit



## Chip Information

TRANSISTOR COUNT: 30  
PROCESS: BICMOS

# Ultra-Low-Power Precision Series Voltage Reference

## Package Information

(The package drawing(s) in this data sheet may not reflect the most current specifications. For the latest package outline information, go to [www.maxim-ic.com/packages](http://www.maxim-ic.com/packages).)

**MAX6029**

SOT-23 5L, EPS

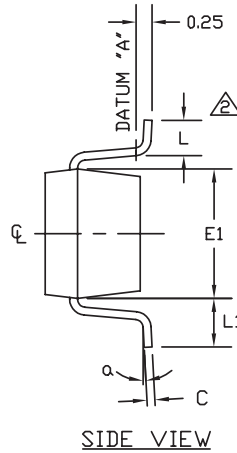
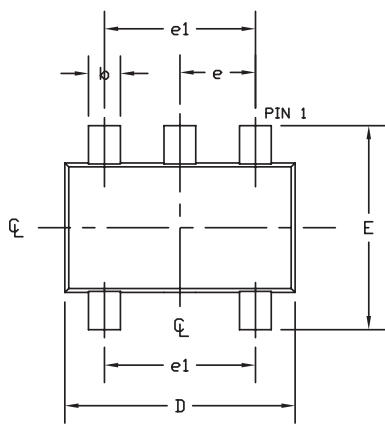

SYMBOL	MIN	NOM	MAX
A	0.90	1.25	1.45
A1	0.00	0.05	0.15
A2	0.90	1.10	1.30
b	0.35	0.40	0.50
C	0.08	0.15	0.20
D	2.80	2.90	3.00
E	2.60	2.80	3.00
E1	1.50	1.625	1.75
L	0.35	0.45	0.60
L1	0.60 REF		
e	0.95 BSC.		
e1	1.90 BSC.		
a	0°	2.5°	8°
PKG CODES: U5-1, U5-2			

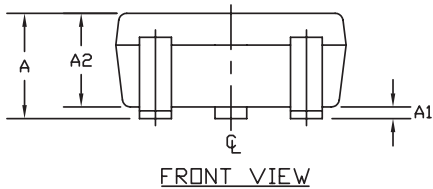

**NOTES:**

1. ALL DIMENSIONS ARE IN MILLIMETERS.
2. FOOT LENGTH MEASURED AT INTERCEPT POINT BETWEEN DATUM A & LEAD SURFACE.
3. PACKAGE OUTLINE EXCLUSIVE OF MOLD FLASH & METAL BURR. MOLD FLASH, PROTRUSION OR METAL BURR SHOULD NOT EXCEED 0.25 MM.
4. PACKAGE OUTLINE INCLUSIVE OF SOLDER PLATING.
5. MEETS JEDEC MO17B, VARIATION AA.
6. LEADS TO BE COPLANAR WITHIN 0.10 mm.
7. SOLDER THICKNESS MEASURED AT FLAT SECTION OF LEAD BETWEEN 0.08mm AND 0.15mm FROM LEAD TIP.

<small>PROPRIETARY INFORMATION</small>	
TITLE: PACKAGE OUTLINE, SOT-23, 5L	
APPROVAL:	DOCUMENT CONTROL NO. 21-0057
REV. F	1/1

# Ultra-Low-Power Precision Series Voltage Reference

## Package Information (continued)

(The package drawing(s) in this data sheet may not reflect the most current specifications. For the latest package outline information, go to [www.maxim-ic.com/packages](http://www.maxim-ic.com/packages).)

SOICN .EPS

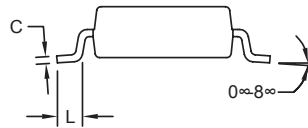
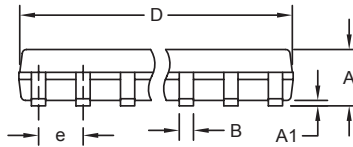
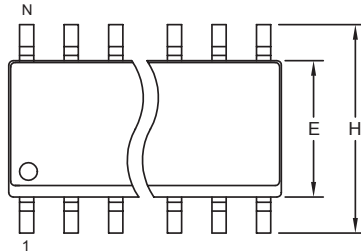

DIM	INCHES		MILLIMETERS	
	MIN	MAX	MIN	MAX
A	0.053	0.069	1.35	1.75
A1	0.004	0.010	0.10	0.25
B	0.014	0.019	0.35	0.49
C	0.007	0.010	0.19	0.25
e	0.050 BSC		1.27 BSC	
E	0.150	0.157	3.80	4.00
H	0.228	0.244	5.80	6.20
L	0.016	0.050	0.40	1.27

VARIATIONS:

DIM	INCHES		MILLIMETERS		N	MS012
	MIN	MAX	MIN	MAX		
D	0.189	0.197	4.80	5.00	8	AA
D	0.337	0.344	8.55	8.75	14	AB
D	0.386	0.394	9.80	10.00	16	AC

NOTES:

1. D&E DO NOT INCLUDE MOLD FLASH.
2. MOLD FLASH OR PROTRUSIONS NOT TO EXCEED 0.15mm (.006").
3. LEADS TO BE COPLANAR WITHIN 0.10mm (.004").
4. CONTROLLING DIMENSION: MILLIMETERS.
5. MEETS JEDEC MS012.
6. N = NUMBER OF PINS.

<small>PROPRIETARY INFORMATION</small>	
<small>TITLE:</small> <b>PACKAGE OUTLINE, .150" SOIC</b>	
<small>APPROVAL</small>	<small>DOCUMENT CONTROL NO.</small> 21-0041
	<small>REV.</small> B 1/1

## Revision History

Pages changed at Rev 1: 1, 2, 13, 15, 16  
 Pages changed at Rev 2: 1, 3, 6, 16

Maxim cannot assume responsibility for use of any circuitry other than circuitry entirely embodied in a Maxim product. No circuit patent licenses are implied. Maxim reserves the right to change the circuitry and specifications without notice at any time.

16 **Maxim Integrated Products, 120 San Gabriel Drive, Sunnyvale, CA 94086 408-737-7600**



SITE  
SEARCHPART NO.  
SEARCH

WHAT'S NEW

PRODUCTS

SOLUTIONS

DESIGN

APPNOTES

SUPPORT

BUY

COMPANY

MEMBERS

[Maxim](#) > [Products](#) > [Voltage References](#)

# MAX6029

Ultra-Low-Power Precision Series Voltage Reference

[QuickView](#)[Technical Documents](#)[Ordering Info](#)[More Information](#)[All](#)

## Ordering Information

Notes:

1. Other options and links for purchasing parts are listed at: <http://www.maxim-ic.com/sales>.
2. [Didn't Find What You Need?](#) Ask our applications engineers. Expert assistance in finding parts, usually within one business day.
3. Part number suffixes: T or T&R = tape and reel; + = RoHS/lead-free; # = RoHS/lead-exempt. More: See [Full Data Sheet](#) or [Part Naming Conventions](#).
4. \* Some packages have variations, listed on the drawing. "PkgCode/Variation" tells which variation the product uses.

### Devices: 1-28 of 28

MAX6029	Free Sample	Buy	Package: TYPE PINS FOOTPRINT DRAWING CODE/VAR *	Temp	RoHS/Lead-Free? Materials Analysis
MAX6029ESA41+T			SOIC;8 pin;31 mm Dwg: <a href="#">21-0041B</a> (PDF) Use pkgcode/variation: S8+2*	-40C to +85C	RoHS/Lead-Free: <a href="#">Lead Free Materials Analysis</a>
MAX6029ESA41+			SOIC;8 pin;31 mm Dwg: <a href="#">21-0041B</a> (PDF) Use pkgcode/variation: S8+2*	-40C to +85C	RoHS/Lead-Free: <a href="#">Lead Free Materials Analysis</a>
MAX6029ESA25+T			SOIC;8 pin;31 mm Dwg: <a href="#">21-0041B</a> (PDF) Use pkgcode/variation: S8+2*	-40C to +85C	RoHS/Lead-Free: <a href="#">Lead Free Materials Analysis</a>
MAX6029ESA25+			SOIC;8 pin;31 mm Dwg: <a href="#">21-0041B</a> (PDF) Use pkgcode/variation: S8+2*	-40C to +85C	RoHS/Lead-Free: <a href="#">Lead Free Materials Analysis</a>
MAX6029EUK25			SOT-23;5 pin;9 mm Dwg: <a href="#">21-0057F</a> (PDF) Use pkgcode/variation: U5-1*	-40C to +85C	RoHS/Lead-Free: <a href="#">No Materials Analysis</a>
MAX6029EUK30+			SOT-23;5 pin;9 mm Dwg: <a href="#">21-0057F</a> (PDF) Use pkgcode/variation: U5+1*	-40C to +85C	RoHS/Lead-Free: <a href="#">Lead Free Materials Analysis</a>
MAX6029EUK30			SOT-23;5 pin;9 mm Dwg: <a href="#">21-0057F</a> (PDF) Use pkgcode/variation: U5-1*	-40C to +85C	RoHS/Lead-Free: <a href="#">No Materials Analysis</a>
MAX6029EUK33+			SOT-23;5 pin;9 mm Dwg: <a href="#">21-0057F</a> (PDF) Use pkgcode/variation: U5+1*	-40C to +85C	RoHS/Lead-Free: <a href="#">Lead Free Materials Analysis</a>
MAX6029EUK33			SOT-23;5 pin;9 mm Dwg: <a href="#">21-0057F</a> (PDF) Use pkgcode/variation: U5-1*	-40C to +85C	RoHS/Lead-Free: <a href="#">No Materials Analysis</a>
MAX6029EUK41+			SOT-23;5 pin;9 mm Dwg: <a href="#">21-0057F</a> (PDF) Use pkgcode/variation: U5+1*	-40C to +85C	RoHS/Lead-Free: <a href="#">Lead Free Materials Analysis</a>
MAX6029EUK41			SOT-23;5 pin;9 mm Dwg: <a href="#">21-0057F</a> (PDF) Use pkgcode/variation: U5-1*	-40C to +85C	RoHS/Lead-Free: <a href="#">No Materials Analysis</a>
MAX6029EUK50+			SOT-23;5 pin;9 mm Dwg: <a href="#">21-0057F</a> (PDF) Use pkgcode/variation: U5+1*	-40C to +85C	RoHS/Lead-Free: <a href="#">Lead Free Materials Analysis</a>
MAX6029EUK50			SOT-23;5 pin;9 mm Dwg: <a href="#">21-0057F</a> (PDF) Use pkgcode/variation: U5-1*	-40C to +85C	RoHS/Lead-Free: <a href="#">No Materials Analysis</a>

MAX6029EUK25+			SOT-23;5 pin;9 mm Dwg: <a href="#">21-0057F (PDF)</a> Use pkgcode/variation: U5+1*	-40C to +85C	RoHS/Lead-Free: <a href="#">Lead Free Materials Analysis</a>
MAX6029EUK21			SOT-23;5 pin;9 mm Dwg: <a href="#">21-0057F (PDF)</a> Use pkgcode/variation: U5-1*	-40C to +85C	RoHS/Lead-Free: <a href="#">No Materials Analysis</a>
MAX6029EUK21+			SOT-23;5 pin;9 mm Dwg: <a href="#">21-0057F (PDF)</a> Use pkgcode/variation: U5+1*	-40C to +85C	RoHS/Lead-Free: <a href="#">Lead Free Materials Analysis</a>
MAX6029EUK25-T			SOT-23;5 pin;9 mm Dwg: <a href="#">21-0057F (PDF)</a> Use pkgcode/variation: U5-1*	-40C to +85C	RoHS/Lead-Free: <a href="#">No Materials Analysis</a>
MAX6029EUK30-T			SOT-23;5 pin;9 mm Dwg: <a href="#">21-0057F (PDF)</a> Use pkgcode/variation: U5-1*	-40C to +85C	RoHS/Lead-Free: <a href="#">No Materials Analysis</a>
MAX6029EUK33-T			SOT-23;5 pin;9 mm Dwg: <a href="#">21-0057F (PDF)</a> Use pkgcode/variation: U5-1*	-40C to +85C	RoHS/Lead-Free: <a href="#">No Materials Analysis</a>
MAX6029EUK41-T			SOT-23;5 pin;9 mm Dwg: <a href="#">21-0057F (PDF)</a> Use pkgcode/variation: U5-1*	-40C to +85C	RoHS/Lead-Free: <a href="#">No Materials Analysis</a>
MAX6029EUK50-T			SOT-23;5 pin;9 mm Dwg: <a href="#">21-0057F (PDF)</a> Use pkgcode/variation: U5-1*	-40C to +85C	RoHS/Lead-Free: <a href="#">No Materials Analysis</a>
MAX6029EUK21+T			SOT-23;5 pin;9 mm Dwg: <a href="#">21-0057F (PDF)</a> Use pkgcode/variation: U5+1*	-40C to +85C	RoHS/Lead-Free: <a href="#">Lead Free Materials Analysis</a>
MAX6029EUK25+T			SOT-23;5 pin;9 mm Dwg: <a href="#">21-0057F (PDF)</a> Use pkgcode/variation: U5+1*	-40C to +85C	RoHS/Lead-Free: <a href="#">Lead Free Materials Analysis</a>
MAX6029EUK30+T			SOT-23;5 pin;9 mm Dwg: <a href="#">21-0057F (PDF)</a> Use pkgcode/variation: U5+1*	-40C to +85C	RoHS/Lead-Free: <a href="#">Lead Free Materials Analysis</a>
MAX6029EUK33+T			SOT-23;5 pin;9 mm Dwg: <a href="#">21-0057F (PDF)</a> Use pkgcode/variation: U5+1*	-40C to +85C	RoHS/Lead-Free: <a href="#">Lead Free Materials Analysis</a>
MAX6029EUK41+T			SOT-23;5 pin;9 mm Dwg: <a href="#">21-0057F (PDF)</a> Use pkgcode/variation: U5+1*	-40C to +85C	RoHS/Lead-Free: <a href="#">Lead Free Materials Analysis</a>
MAX6029EUK50+T			SOT-23;5 pin;9 mm Dwg: <a href="#">21-0057F (PDF)</a> Use pkgcode/variation: U5+1*	-40C to +85C	RoHS/Lead-Free: <a href="#">Lead Free Materials Analysis</a>
MAX6029EUK21-T			SOT-23;5 pin;9 mm Dwg: <a href="#">21-0057F (PDF)</a> Use pkgcode/variation: U5-1*	-40C to +85C	RoHS/Lead-Free: <a href="#">No Materials Analysis</a>

#### Didn't Find What You Need?

- [Next Day Product Selection Assistance from Applications Engineers](#)
- [Parametric Search](#)
- [Applications Help](#)

#### QuickView

[Description](#)  
[Key Features](#)  
[Applications/Uses](#)  
[Key Specifications](#)  
[Diagram](#)

#### Technical Documents

[Data Sheet](#)  
[Application Notes](#)  
[Design Guides](#)  
[Engineering Journals](#)  
[Reliability Reports](#)  
[Software/Models](#)  
[Evaluation Kits](#)

#### Ordering Info

[Price and Availability](#)  
[Samples](#)  
[Buy Online](#)  
[Package Information](#)  
[Lead-Free Information](#)

#### More Information

[Related Products](#)  
[Notes and Comments](#)  
[Evaluation Kits](#)

Document Ref.: 19-2892; Rev 2; 2006-11-21  
This page last modified: 2007-08-13

[CONTACT US: SEND US AN EMAIL](#)