

EVAL-ADP1712/ADP1713/ADP1714

FEATURES

- Input voltage range: 2.5 V to 5.5 V**
- Output current range: 0 mA to 300 mA**
- Output voltage accuracy: $\pm 1\%$**
- Operating temperature range: -40°C to $+125^{\circ}\text{C}$**
- External soft start (ADP1712 fixed)**
- Adjustable output voltages (ADP1712 adjustable)**
- Reference bypass to reduce noise (ADP1713)**
- Track mode (ADP1714)**

GENERAL DESCRIPTION

The ADP1712/ADP1713/ADP1714 evaluation boards are used to demonstrate the functionality of the ADP1712, ADP1713, and ADP1714 series of linear regulators. Depending on what component combinations are used, the evaluation board can be used for ADP1712 fixed output voltage devices with soft start, ADP1712 adjustable output voltage devices, ADP1713 fixed output voltage devices with a bypass capacitor, and ADP1714 fixed output voltage devices with tracking.

Simple device measurements such as line and load regulation, dropout, and ground current can be demonstrated with just a single voltage supply, a voltage meter, a current meter, and load resistors.

For more details about the [ADP1712/ADP1713/ADP1714](http://www.analog.com) linear regulators, visit www.analog.com.

EVALUATION BOARD

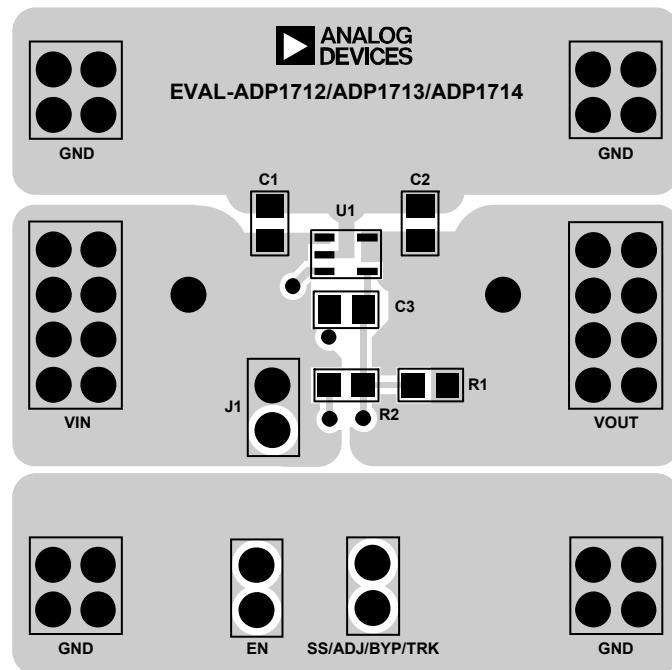

Figure 1.

Rev. 0

Evaluation boards are only intended for device evaluation and not for production purposes. Evaluation boards as supplied "as is" and without warranties of any kind, express, implied, or statutory including, but not limited to, any implied warranty of merchantability or fitness for a particular purpose. No license is granted by implication or otherwise under any patents or other intellectual property by application or use of evaluation boards. Information furnished by Analog Devices is believed to be accurate and reliable. However, no responsibility is assumed by Analog Devices for its use, nor for any infringements of patents or other rights of third parties that may result from its use. Analog Devices reserves the right to change devices or specifications at any time without notice. Trademarks and registered trademarks are the property of their respective owners. Evaluation boards are not authorized to be used in life support devices or systems.

TABLE OF CONTENTS

Features	1	Line Regulation.....	5
General Description	1	Load Regulation	6
Evaluation Board	1	Dropout Voltage	6
Revision History	2	Ground Current Measurements	7
Evaluation Board Hardware and Schematic	3	Ground Current Consumption	7
Evaluation Board Configurations.....	4	Ordering Information.....	8
ADP1712 Fixed Output with Soft Start.....	4	Bill of Materials.....	8
ADP1712 Adjustable Output	4	Ordering Guide	8
ADP1713 Fixed Output with Bypass	4	ESD Caution.....	8
ADP1714 Fixed Output with Tracking.....	4		
Output Voltage Measurements	5		

REVISION HISTORY

3/07—Revision 0: Initial Version

EVALUATION BOARD HARDWARE AND SCHEMATIC

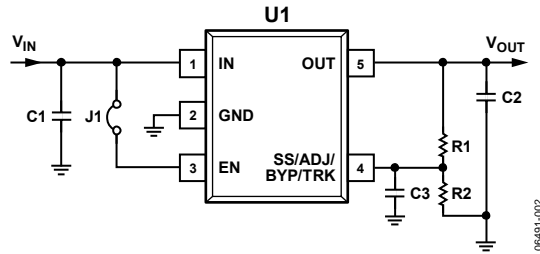

Figure 2. Evaluation Board Schematic

Table 1. Evaluation Board Hardware Components

Component	Function	Description
U1 ¹	Linear regulator	ADP1712/ADP1713/ADP1714 Low Dropout Linear Regulator.
C1	Input capacitor	2.2 μ F Input Bypass Capacitor.
C2	Output capacitor	2.2 μ F Output Capacitor. Required for stability and transient performance.
C3 ²	Soft start/bypass capacitor	10 nF Soft Start Capacitor (ADP1712 Fixed Version) or 10 nF Bypass Capacitor (ADP1713). Soft start capacitor determines V_{OUT} ramp-up time during startup. Bypass capacitor reduces output noise and improves PSRR.
R1, R2 ³	Output voltage adjust resistors	External Resistors. Used to set V_{OUT} with the ADP1712 adjustable version.
J1	Jumper	Jumper. Connects EN to IN for automatic startup.

¹ Component varies depending on the evaluation board type ordered.

² Present only on boards with ADP1712 fixed output devices and ADP1713.

³ Present only on boards with ADP1712 adjustable output devices.

EVAL-ADP1712/ADP1713/ADP1714

EVALUATION BOARD CONFIGURATIONS

The ADP1712/ADP1713/ADP1714 evaluation boards come supplied with different components depending on which version is ordered. Components common to all versions are C1, C2, and J1.

ADP1712 FIXED OUTPUT WITH SOFT START

Evaluation boards that come supplied with the ADP1712 fixed output voltage option devices has the additional C3 soft start capacitor. This capacitor controls the rise time when the output voltage starts up. Figure 3 shows the schematic of this evaluation board configuration.

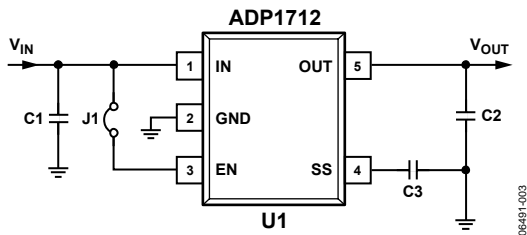

Figure 3. ADP1712 Fixed Output with Soft Start

ADP1712 ADJUSTABLE OUTPUT

Evaluation boards that come supplied with ADP1712 adjustable output voltage option devices have the additional R1 and R2 resistors to set the output voltage. Figure 4 shows the schematic of this evaluation board configuration.

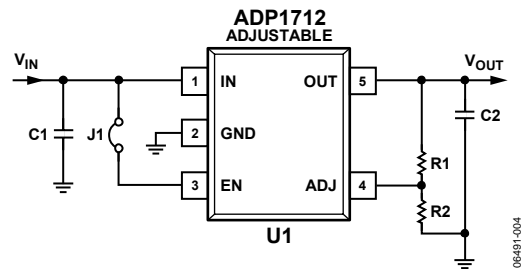

Figure 4. ADP1712 Adjustable Output

The output voltage is set based on the following equation:

$$V_{OUT} = 0.8 V \left(1 + \frac{R1}{R2}\right)$$

For example, if R1 = 10 kΩ and R2 = 4.99 kΩ, then V_{OUT} is 2.403 V.

ADP1713 FIXED OUTPUT WITH BYPASS

Evaluation boards that come supplied with ADP1713 fixed output voltage option devices has the additional C3 bypass capacitor to reduce the output noise and improve PSRR. Figure 5 shows the schematic of this evaluation board configuration.

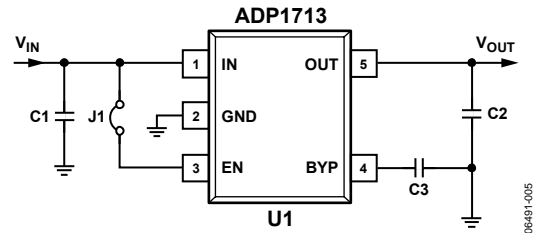

Figure 5. ADP1713 Fixed Output with Bypass

ADP1714 FIXED OUTPUT WITH TRACKING

Evaluation boards that come supplied with ADP1714 fixed output voltage option devices with tracking do not have C3, R1, or R2 populated. The user can instead connect an external voltage to the SS/ADJ/BYP/TRK pad of the evaluation board to use the track function. Figure 6 shows the schematic of this evaluation board configuration.

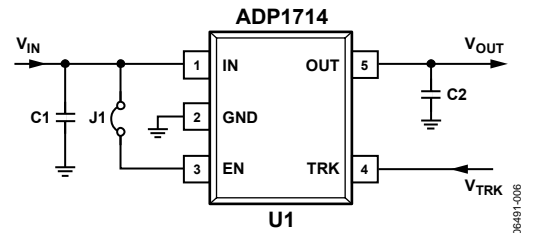

Figure 6. ADP1714 Fixed Output with Tracking

OUTPUT VOLTAGE MEASUREMENTS

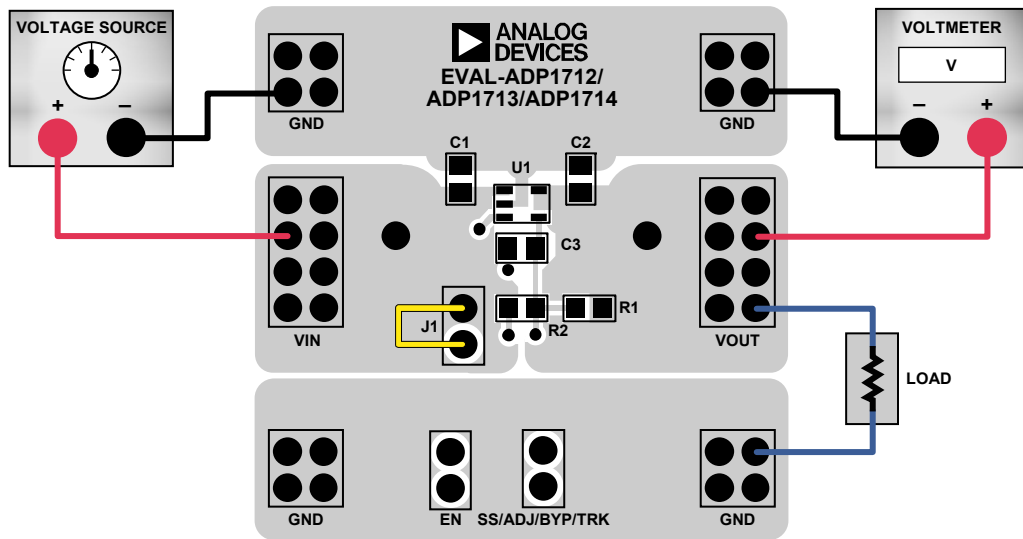

Figure 7. Output Voltage Measurement

06491-007

Figure 7 shows how the evaluation board can be connected to a voltage source and a voltage meter for basic output voltage accuracy measurements. A resistor can be used as the load for the regulator. Ensure that the resistor has a power rating adequate to handle the power expected to be dissipated across it. An electronic load can also be used as an alternative. Ensure that the voltage source can supply enough current for the expected load levels.

Follow these steps to connect to a voltage source and voltage meter:

1. Connect the negative terminal (–) of the voltage source to one of the GND pads on the evaluation board.
2. Connect the positive terminal (+) of the voltage source to the VIN pad of the evaluation board.
3. Connect a load between the VOUT pad and one of the GND pads.
4. Connect the negative terminal (–) of the voltage meter to one of the GND pads, and the positive terminal (+) of the voltage meter to the VOUT pad.
5. The voltage source can now be turned on. If J1 is inserted (this connects EN to VIN for automatic startup), then the regulator powers up.

If the load current is large, the user needs to connect the voltage meter as close as possible to the output capacitor to reduce the effects of IR drops.

LINE REGULATION

For line regulation measurements, the regulator’s output is monitored while its input is varied. For good line regulation, the output must change as little as possible with varying input levels. To ensure the device is not in dropout during this measurement, V_{IN} must be varied between $V_{OUT_{NOM}} + 0.5\text{ V}$ (or 2.5 V , whichever is greater) and $V_{IN_{MAX}}$. For example, for an ADP1712 with fixed 3.3 V output, V_{IN} needs to be varied between 3.8 V and 5.5 V . This measurement can be repeated under different load conditions. Figure 8 shows the typical line regulation performance of an ADP1712 with fixed 3.3 V output.

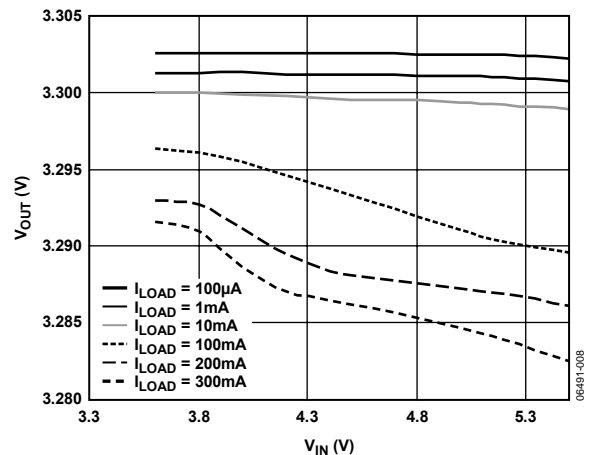

Figure 8. Output Voltage vs. Input Voltage

06491-008

EVAL-ADP1712/ADP1713/ADP1714

LOAD REGULATION

For load regulation measurements, the regulator's output is monitored while the load is varied. For good load regulation, the output must change as little as possible with varying load. The input voltage must be held constant during this measurement. The load current can be varied from 0 mA to 300 mA. Figure 9 shows the typical load regulation performance of an ADP1712 with fixed 3.3 V output for an input voltage of 3.8 V.

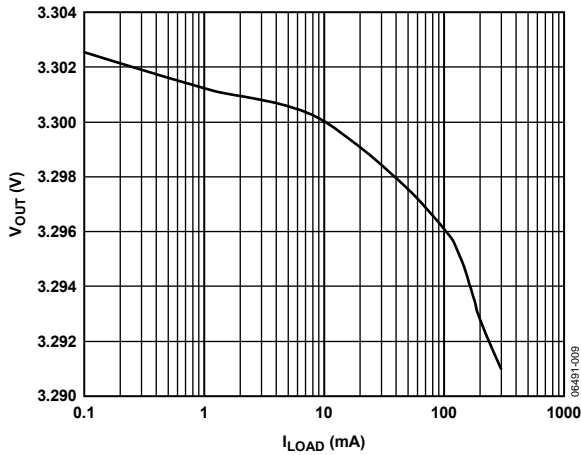

Figure 9. Output Voltage vs. Load Current

DROPOUT VOLTAGE

Dropout voltage can be measured using the configuration shown in Figure 7. Dropout voltage is defined as the input-to-output voltage differential when the input voltage is set to the nominal output voltage. This applies only for output voltages above 2.5 V. Dropout voltage increases with larger loads. For more accurate measurements, a second voltage meter can be used to monitor the input voltage across the input capacitor. The input supply voltage may need to be adjusted to account for IR drops, especially if large load currents are used. Figure 10 shows a typical curve of dropout voltage measurements with different load currents.

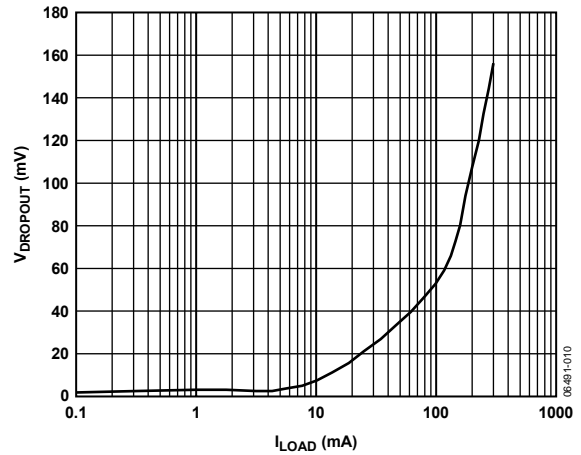

Figure 10. Dropout Voltage vs. Load Current

GROUND CURRENT MEASUREMENTS

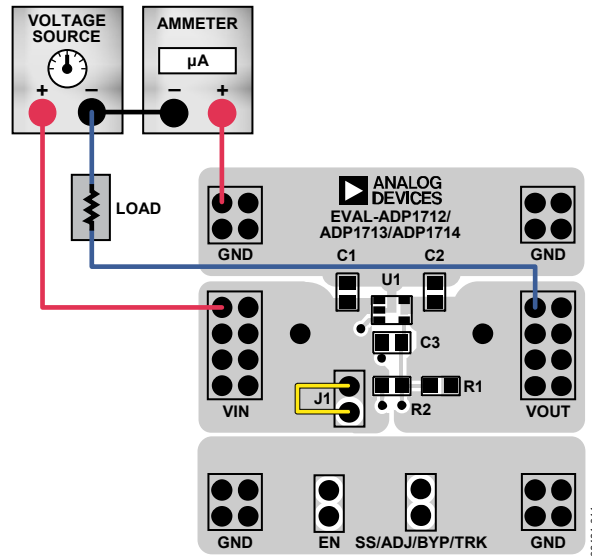

Figure 11. Ground Current Measurement

Figure 11 shows how the evaluation board can be connected to a voltage source and an ammeter for ground current measurements. A resistor can be used as the load for the regulator. Ensure that the resistor has a power rating adequate to handle the power expected to be dissipated across it. An electronic load can be used as an alternative. Ensure that the voltage source used can supply enough current for the expected load levels.

Follow these steps to connect to a voltage source and ammeter:

1. Connect the positive terminal (+) of the voltage source to the VIN pad on the evaluation board.
2. Connect the positive terminal (+) of the ammeter to one of the GND pads of the evaluation board.
3. Connect the negative terminal (-) of the ammeter to the negative (-) terminal of the voltage source.
4. Connect a load between the VOUT pad of the evaluation board and the negative (-) terminal of the voltage source.
5. The voltage source can now be turned on. If J1 is inserted (this connects EN to VIN for automatic startup), then the regulator powers up.

GROUND CURRENT CONSUMPTION

Ground current measurements are a way of determining how much current the regulator's internal circuits are consuming while performing the regulation function. To be efficient, the regulator needs to consume as little current as possible. Typically, the regulator uses the maximum current when

supplying its largest load level (300 mA). Figure 12 shows the typical ground current consumption for various load levels.

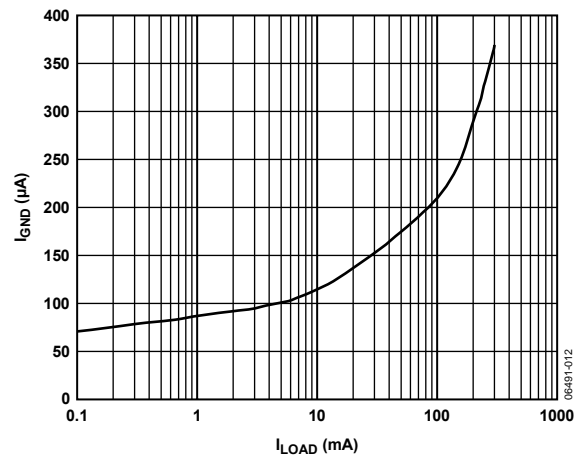

Figure 12. Ground Current vs. Load Current

When the device is disabled (EN = GND), ground current drops to less than 1 µA.

Note: Larger ground current levels occur when using an evaluation board with R1 and R2 present.

EVAL-ADP1712/ADP1713/ADP1714

ORDERING INFORMATION

BILL OF MATERIALS

Table 2.

Qty	Reference Designator	Description	Manufacturer/Vendor	Vendor Part No.
2	C1, C2	Capacitor, MLCC, 2.2 μ F, 16 V, 0805, X5R	Murata or equivalent	GRM21BR61C225KA88
1	C3	Capacitor, MLCC, 10 nF, 16 V, 0805, X5R	Murata or equivalent	GRM21BR72A103KA01
2	R1, R2	Resistor, 10 k Ω , 1%, 0805	Vishay Dale or equivalent	CRCW080510K0FKEA
1	J1	Header, single, STR, 2 pins	Digi-Key, Corp.	S1012E-36-ND
4	U1	IC, LDO regulator	Analog Devices, Inc.	ADP1712AUJZ-3.3-R7 ADP1712AUJZ-R7 ADP1713AUJZ-3.3-R7 ADP1714AUJZ-3.3-R7

ORDERING GUIDE

Model	Output Voltage	Description
ADP1712-3.3-EVALZ ¹	3.3 V	ADP1712 Fixed 3.3 V Output with Soft Start Evaluation Board
ADP1712-EVALZ ¹	Adjustable, but set to 1.6 V	ADP1712 Adjustable Output Evaluation Board
ADP1713-3.3-EVALZ ¹	3.3 V	ADP1713 Fixed 3.3 V Output with Bypass Evaluation Board
ADP1714-3.3-EVALZ ¹	3.3 V	ADP1714 Fixed 3.3 V Output with Track Mode Evaluation Board

¹ Z = RoHS Compliant Part.

ESD CAUTION



ESD (electrostatic discharge) sensitive device.

Charged devices and circuit boards can discharge without detection. Although this product features patented or proprietary protection circuitry, damage may occur on devices subjected to high energy ESD. Therefore, proper ESD precautions should be taken to avoid performance degradation or loss of functionality.