

**Sensitive Snap-Action Pushbutton Switches — Solder and P.C. Terminals (Momentary Action)**

**PS SERIES** 5 AMP. (S.P.)  
1 AMP. (D.P.)  
0.4 VA

**DIRECT PANEL MOUNT**



ONE POLE

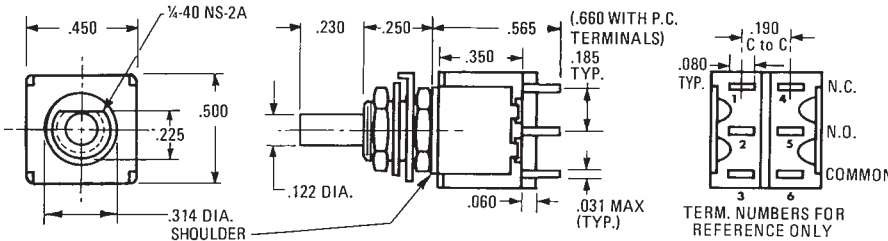

TWO POLE

Basic P/N	Terminal Type	Poles	Cap Size	Cap Color	Contact Material-Type
PS	1 - Solder lug 2 - Printed Circuit Terminals	1 - One ① 2 - Two ①	0 - No Cap 1 - .200 Dia. 2 - .375 Dia. 3 - .450 Sq. 4 - .310 Dia. 5 - .780 Sq. ③	0 - No Cap 1 - Black 2 - White 3 - Ted	B - Gold/Nickel/Brass ② G - Gold/Nickel/Silver ① ② Q - Coin Silver ①

- ① Single pole circuit rated 5 amps, double pole circuit rated 1 amp.
- ② Ratings are 0.4 VA — 28 BAC or DC
- ③ Supplied with .90" square black bezel as Standard

**EXAMPLES:**

PS1-100Q = One-pole, S.L., 5 amp., No Cap, Coin Silver Contacts

PS2-221B = Two-pole, PC, .4 VA, .375 Dia., Black Cap., Gold/Nickel/Brass Contacts

NEW .780" SQUARE CAP AND BEZEL



W-NU-29A

DECORATIVE FACE NUTS (SEE NOTE UNDER MATERIALS)

W-NU-30A

**SPECIFICATIONS**

**Contact Rating** — Letter codes G and Q (1 Pole) 5 amp resistive @ 125 VAC (U.L. recognized, CSA certified) or 5 amp resistive @ 28 VDC. (2 pole) 1 amp resistive @ 125 VAC (U.L. recognized, CSA certified) or 1 amp resistive @ 28 VDC.  
Letter codes B and G — (1 and 2 Poles) 0.4 Volt-amps (VA) maximum @ 28 V max. (AC or DC).  
**Contact Resistance** — 50 milliohms maximum.  
**Insulation Resistance** — 1,000 megohms minimum.  
**Dielectric Strength** — 1,000 volts RMS minimum at sea level.  
**Electrical Life** — 60,000 cycles minimum at full load-resistive.  
**Maximum Allowable Installation Force on Plunger** — 10 pounds.  
Multi-pole contacts do not make and break simultaneously.

**MATERIALS**

**Case** — Diallyl Phthalate.  
**Bushing** — Brass, nickel plated.  
**Housing** — Stainless steel.  
**Plunger** — Thermoplastic.  
**Common Contact** — Refer to contact material table above.  
**Center & End Contact** — Refer to contact material table above.  
**Hardware** — (2) Hex nuts W-NU-11, brass nickel plated. (1) Internal tooth lockwasher W-WA-16, steel chromium plated. (1) Locking Ring W-RI-16, C.R.S. nickel plated.  
**Decorative Face Nuts** — Brass, bright chrome plated. See Page 16 for complete dimensions.



Description	P/N	Color
Small Cap .200	W-KN-16	Black
	W-KN-16A	White
	W-KN-16B	Red
Medium Cap .310	W-KN-32	Black
	W-KN-32A	White
Large Cap .375	W-KN-17	Black
	W-KN-17A	White
Square Cap .450	W-KN-18	Black
	W-KN-18A	White
.780 Square Cap	W-KN-18B	Red
	W-KN-52	Black
.90 Square Bezel	W-KN-52A	White
	W-KN-52B	Red
	Bezel W-BZ-21	Black

**Solder Lug Terminal**

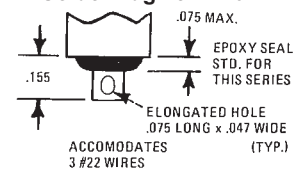

**Printed Circuit Terminal**

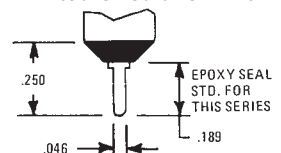

**PS**  
SERIES 5 AMP. (S.P.)  
0.4VA

**Sensitive Snap-Action Pushbutton Switches —  
P.C. Terminals (Momentary Action)**

**RIGHT ANGLE MOUNT IN P.C. BOARDS (HORIZONTAL)**

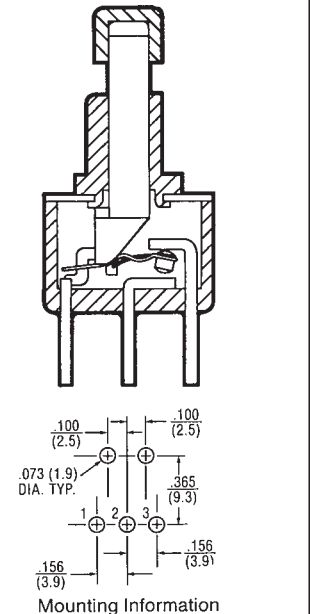

Basic P/N	Terminal Type	Poles	Cap Size	Cap Color	Contact Material-Type
PS	5 - Rt. Angle P.C. Mount 6 - Rt. Angle P.C. Mount	1 - One	0 - No Cap 1 - .200 Dia. 2 - .375 Dia. 3 - .450 Sq. 4 - .310 Dia.	0 - No Cap 1 - Black 2 - White 3 - Red	B - Gold/Nickel/Brass ② G - Gold/Nickel/Silver ①② Q - Coin Silver ②

- ① Rating is 5 amps — 125 VAC or 28 VDC.
- ② Ratings are 0.4 VA — 28 VAC or DC.

**ORDERING EXAMPLES:**

PS5-100G = (Rt. Angle P.C. mount 5 amp.) One-pole No Cap No Color Gold/Nickel/Silver Contacts

P
S
5
-
1
0
0
-
G

PS6-121Q = (Rt. Angle P.C. mount 5 amp.) One-pole .375 Dia. Black Cap Coin Silver Contacts

P
S
6
-
1
2
1
-
Q

**SPECIFICATIONS**

**Contact Rating** — Letter codes G and Q — 5 amp resistive @ 125 VAC or 28 VDC.  
Letter codes B and G — 0.4 volts-amps (VA) maximum @ 28 VAC or DC.

**Contact Resistance** — 50 milliohms maximum.

**Insulation Resistance** — 1,000 megohms minimum.

**Dielectric Strength** — 1,000 volts RMS minimum at sea level.

**Electrical Life** — 60,000 cycles minimum at full load.

**Maximum Allowable Installation Force on Plunger** — 10 pounds.

**MATERIALS**

**Case** — Diallyl Phthalate.

**Bushing** — Brass, nickel plated.

**Housing** — Stainless steel.

**Plunger** — Thermoplastic.

**Common Contact** — Refer to contact material table above.

**Center & End Contact** — Refer to contact material table above.

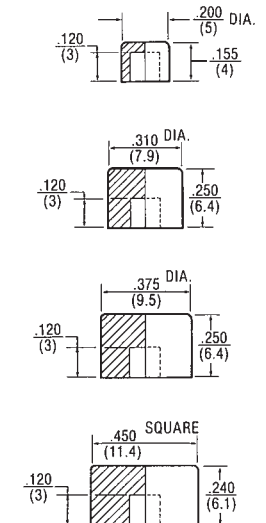

Description	P/N	Color
Small Cap .200	W-KN-16	Black
	W-KN-16A	White
	W-KN-16B	Red
Medium Cap .310	W-KN-32	Black
	W-KN-32A	White
	W-KN-32B	Red
Large Cap .375	W-KN-17	Black
	W-KN-17A	White
	W-KN-17B	Red
Square Cap .450	W-KN-18	Black
	W-KN-18A	White
	W-KN-18B	Red

**Sensitive Snap-Action Pushbutton Switches — P.C. Terminals (Momentary Action)**

<b>PS</b> SERIES	5 AMP. (S.P.)
	1 AMP. (D.P.)
	0.4 VA

**RIGHT ANGLE P.C. MOUNT SWITCHES**

Basic P/N	Terminal Type	Poles	Cap Size	Cap Color	Contact Material-Type
PS	9 - Horizontal Right Angle	1 - One ①	0 - No Cap	0 - No Cap	B - Gold/Nickel/Brass ②
	10 - Vertical Right Angle (.100 Terminal Spacing)		1 - .200 Dia.	1 - Black	G - Gold/Nickel/Silver ① ②
	11 - Vertical Right Angle 0.4 VA (.150 Terminal Spacing)		2 - .375 Dia.	2 - White	Q - Coin Silver ①
		2 - Two ①	3 - .450 Sq.	3 - Red	
			4 - .310 Dia.		

- ① Single pole circuit rated 5 amps, double pole circuit rated 1 amp.
- ② Ratings are 0.4 VA — 28 VAC or DC.

**ORDERING EXAMPLES:**

PS9-100B =	(PC mounted 0.4 VA)	One-pole	No Cap	No Color	Gold/Nickel/Brass Contacts	
	P S 9	-	1	0	0	B
PS10-221Q =	(PC mounted 1 amp.)	Two-pole	.375 Dia.	Black Cap	Coin Silver Contacts	
	P S 10	-	2	2	1	Q

**SPECIFICATIONS**

**Contact Rating** — Letter codes G and Q (1 Pole) 5 amp resistive @ 125 VAC (U.L. recognized, CSA certified) or 5 amp resistive @ 28 VDC. (2 pole) 1 amp resistive @ 125 VAC (U.L. recognized, CSA certified) or 1 amp resistive @ 28 VDC.  
 Letter codes B and G — (1 and 2 Poles) 0.4 Volt-amps (VA) maximum @ 28 V maximum (AC or DC).  
**Contact Resistance** — 50 milliohms maximum.  
**Insulation Resistance** — 1,000 megohms minimum.  
**Dielectric Strength** — 1,000 volts RMS minimum at sea level.  
**Electrical Life** — 60,000 cycles minimum at full load-resistive.  
**Maximum Allowable Installation Force on Plunger** — 10 pounds.  
 Multi-pole contacts do not make and break simultaneously.

**MATERIALS**

**Case** — Diallyl Phthalate.  
**Bushing** — Brass, nickel plated.  
**Housing** — Stainless steel.  
**Plunger** — Thermoplastic.  
**Common Contact** — Refer to contact material table above.  
**Center & End Contact** — Refer to contact material table above.

Description	P/N	Color
Small Cap .200	W-KN-16	Black
	W-KN-16A	White
	W-KN-16B	Red
Medium Cap .310	W-KN-32	Black
	W-KN-32A	White
Large Cap .375	W-KN-17	Black
	W-KN-17A	White
	W-KN-17B	Red
Square Cap .450	W-KN-18	Black
	W-KN-18A	White
	W-KN-18B	Red

**Right Angle P.C. Terminal**

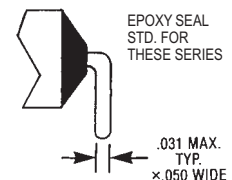

**Sensitive Snap-Action Pushbutton Switches —  
P.C. Terminals (Momentary Action)**

**PS SERIES** 5 AMP. (S.P.)  
1 AMP. (D.P.)  
0.4VA

**RIGHT ANGLE P.C. MOUNT SWITCHES**

**PS 9**

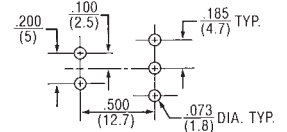
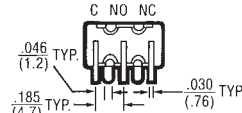
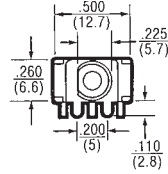

1 Pole P.C. Mounting

ONE POLE

**EPOXY SEALED P.C. TERMINALS ARE SUPPLIED AS STANDARD FOR THESE OPTIONS.**

**PS 9**

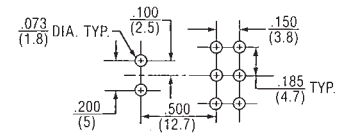
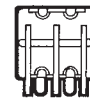
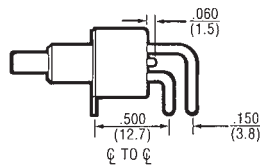
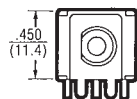

2 Pole P.C. Mounting

TWO POLE

**EPOXY SEALED P.C. TERMINALS ARE SUPPLIED AS STANDARD FOR THESE OPTIONS.**

**PS 10**

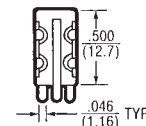
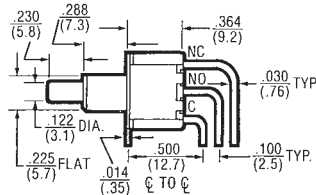
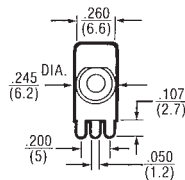

1 Pole P.C. Mounting

ONE POLE

**EPOXY SEALED P.C. TERMINALS ARE SUPPLIED AS STANDARD FOR THESE OPTIONS.**

**PS 10**

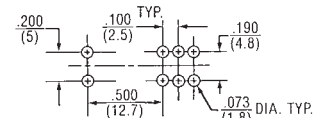
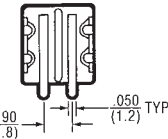
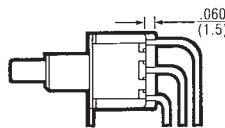

2 Pole P.C. Mounting

TWO POLE

**EPOXY SEALED P.C. TERMINALS ARE SUPPLIED AS STANDARD FOR THESE OPTIONS.**

**PS 11**

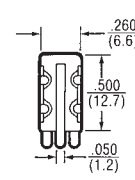
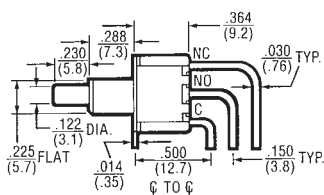
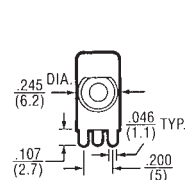

1 Pole P.C. Mounting

ONE POLE

**EPOXY SEALED P.C. TERMINALS ARE SUPPLIED AS STANDARD FOR THESE OPTIONS.**

**PS 11**

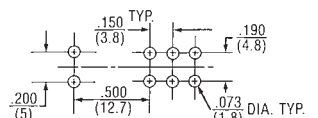
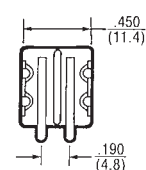
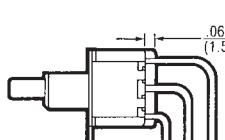

2 Pole P.C. Mounting

TWO POLE

**EPOXY SEALED P.C. TERMINALS ARE SUPPLIED AS STANDARD FOR THESE OPTIONS.**

**Sensitive Snap-Action Pushbutton Switches — P.C. Terminals (Momentary Action)**

**PS SERIES** 5 AMP. (S.P.)  
1 AMP. (D.P.)  
0.4 VA

**VERTICAL P.C. MOUNT (.460 x .620 BRACKET)**

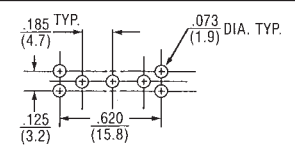
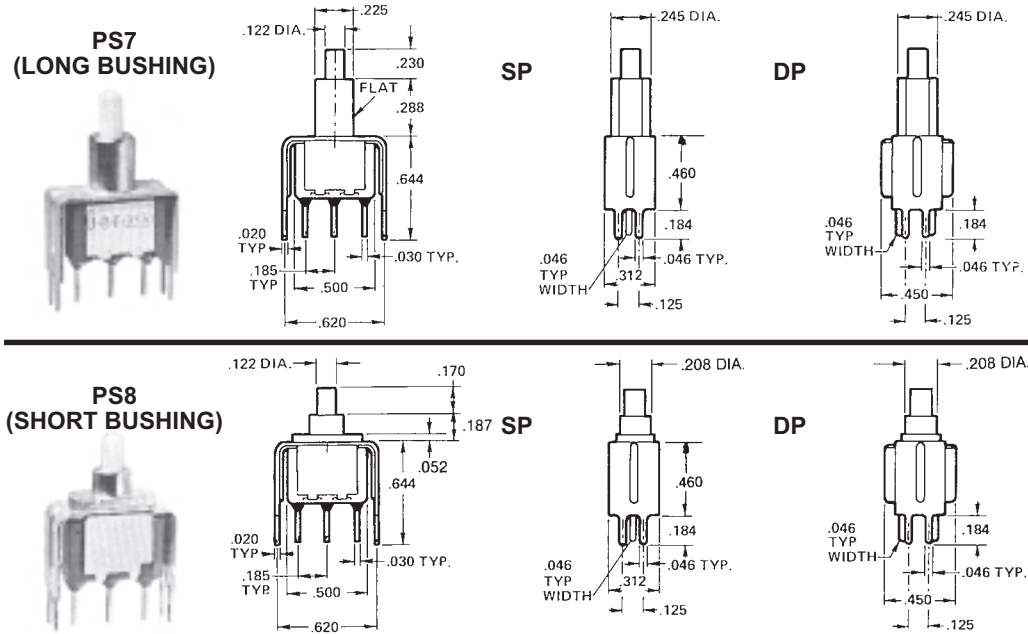

1 Pole P.C. Mounting

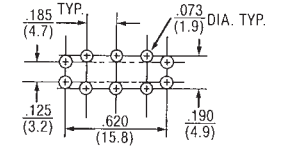

2 Pole P.C. Mounting

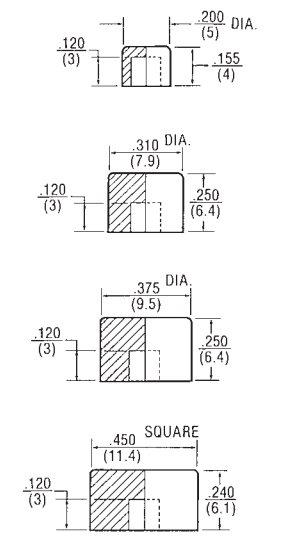

Basic P/N	Terminal Type	Poles	Cap Size	Cap Color	Contact Material-Type
PS	7 - PC Mounted 8 - PC Mounted	1 - One ① 2 - Two ①	0 - No Cap 1 - .200 Dia. 2 - .375 Dia. 3 - .450 Sq. 4 - .310 Dia.	0 - No Cap 1 - Black 2 - White	B - Gold/Nickel/Brass ② G - Gold/Nickel/Silver ① ② Q - Coin Silver ①

① Single pole circuit rated 5 amps, double pole circuit rated 1 amp.  
② Ratings are 0.4 VA — 28 VAC or DC.

**ORDERING EXAMPLES:**

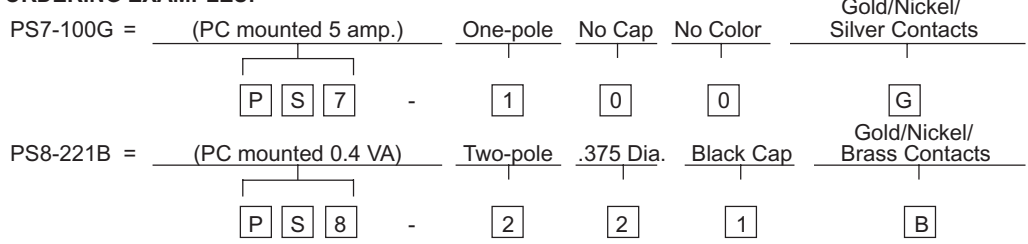

**SPECIFICATIONS**

**Contact Rating** — Letter codes G and Q (1 Pole) 5 amp resistive @ 125 VAC (U.L. recognized, CSA certified) or 5 amp resistive @ 28 VDC. (2 pole) 1 amp resistive @ 125 VAC (U.L. recognized, CSA certified) or 1 amp resistive @ 28 VDC.  
 Letter codes B and G — (1 and 2 Poles) 0.4 Volt-amps (VA) maximum @ 28 V maximum (AC or DC).  
**Contact Resistance** — 50 milliohms maximum.  
**Insulation Resistance** — 1,000 megohms minimum.  
**Dielectric Strength** — 1,000 volts RMS minimum at sea level.  
**Electrical Life** — 60,000 cycles minimum at full load-resistive.  
**Maximum Allowable Installation Force on Plunger** — 10 pounds.  
 Multi-pole contacts do not make and break simultaneously.

**MATERIALS**

**Case** — Diallyl Phthalate.  
**Bushing** — Brass, nickel plated.  
**Housing** — Stainless steel.  
**Plunger** — Thermoplastic.  
**Common Contact** — Refer to contact material table above.  
**Center & End Contact** — Refer to contact material table above.

Description	P/N	Color
Small Cap .200	W-KN-16	Black
	W-KN-16A	White
	W-KN-16B	Red
Medium Cap .310	W-KN-32	Black
	W-KN-32A	White
	W-KN-32B	Red
Large Cap .375	W-KN-17	Black
	W-KN-17A	White
	W-KN-17B	Red
Square Cap .450	W-KN-18	Black
	W-KN-18A	White
	W-KN-18B	Red

**Printed Circuit Terminal**



**Sensitive Snap-Action Pushbutton Switches — P.C. Terminals (Momentary Action)**

**PS SERIES** 5 AMP. (S.P.)  
1 AMP. (D.P.)  
0.4 VA

**VERTICAL P.C. MOUNT (.630 x .620 BRACKET)**

**PS71 (LONG BUSHING)**

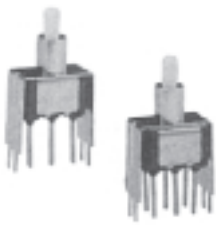

**SP**

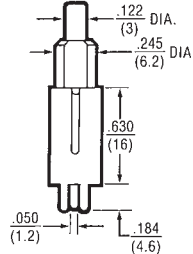

**DP**

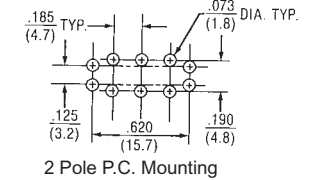
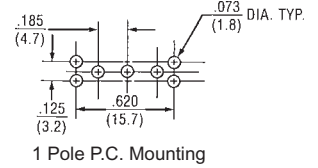
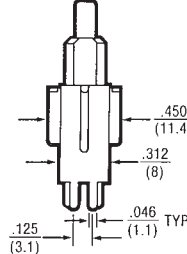

**PS81 (SHORT BUSHING)**

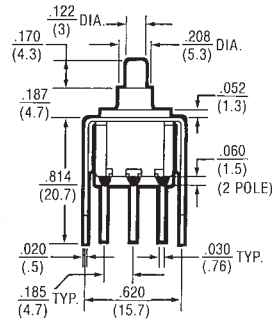
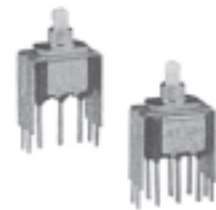

**SP**

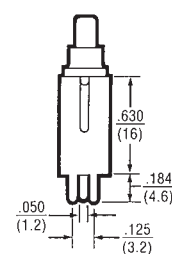

**DP**

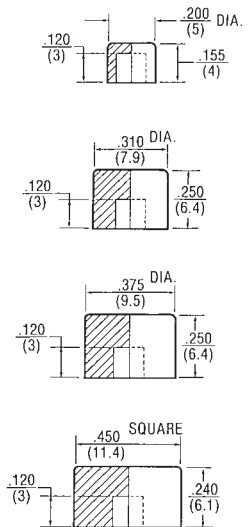
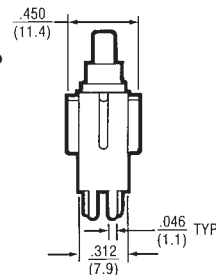

Basic P/N	Terminal Type	Poles	Cap Size	Cap Color	Contact Material-Type
PS	71 - PC Mounted	1 - One ①	0 - No Cap	0 - No Cap	B - Gold/Nickel/Brass ②
	81 - PC Mounted	2 - Two ①	1 - .200 Dia.	1 - Black	G - Gold/Nickel/Silver ① ②
			2 - .375 Dia.	2 - White	Q - Coin Silver ①
			3 - .450 Sq.	3 - Red	
			4 - .310 Dia.		

- ① Single pole circuit rated 5 amps, double pole circuit rated 1 amp.
- ② Ratings are 0.4 VA — 28 VAC or DC.

**ORDERING EXAMPLES:**

PS71-100B= (PC mounted 0.4 VA) One-pole No Cap No Color Gold/Nickel/Brass Contacts

P
S
71
-
1
0
0
B

PS81-221Q= (PC mounted 1 amp.) Two-pole .375 Dia. Black Cap Coin Silver Contacts

P
S
81
-
2
2
1
Q

**SPECIFICATIONS**

**Contact Rating** — Letter codes G and Q (1 Pole) 5 amp resistive @ 125 VAC (U.L. recognized, CSA certified) or 5 amp resistive @ 28 VDC. (2 pole) 1 amp resistive @ 125 VAC (U.L. recognized, CSA certified) or 1 amp resistive @ 28 VDC.

Letter codes B and G — (1 and 2 Poles) 0.4 Volt-amps (VA) maximum @ 28 V maximum (AC or DC).

**Contact Resistance** — 50 milliohms maximum.

**Insulation Resistance** — 1,000 megohms minimum.

**Dielectric Strength** — 1,000 volts RMS minimum at sea level.

**Electrical Life** — 60,000 cycles minimum at full load-resistive.

**Maximum Allowable Installation Force on Plunger** — 10 pounds.

Multi-pole contacts do not make and break simultaneously.

**MATERIALS**

**Case** — Diallyl Phthalate.

**Bushing** — Brass, nickel plated.

**Housing** — Stainless steel.

**Plunger** — Thermoplastic.

**Common Contact** — Refer to contact material table above.

**Center & End Contact** — Refer to contact material table above.

Description	P/N	Color
Small Cap .200	W-KN-16	Black
	W-KN-16A	White
	W-KN-16B	Red
Medium Cap .310	W-KN-32	Black
	W-KN-32A	White
	W-KN-32B	Red
Large Cap .375	W-KN-17	Black
	W-KN-17A	White
	W-KN-17B	Red
Square Cap .450	W-KN-18	Black
	W-KN-18A	White
	W-KN-18B	Red

**Printed Circuit Terminal**



**Sensitive Snap-Action Pushbutton Switches — P.C. Terminals (Momentary Action)**

**PS SERIES** 5 AMP. (S.P.)  
1 AMP. (D.P.)  
0.4 VA

**VERTICAL P.C. MOUNT (.460 x .750 BRACKET)**

**PS72 (LONG BUSHING)**

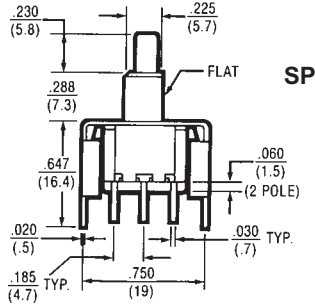

**SP**

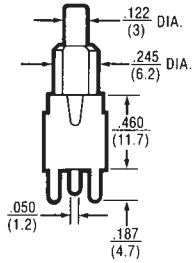

**DP**

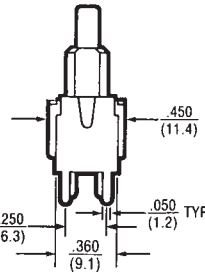

**PS82 (SHORT BUSHING)**

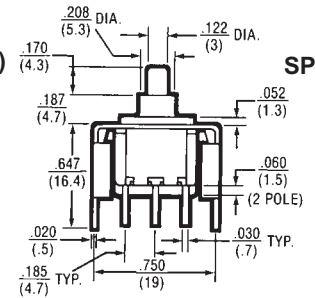

**SP**

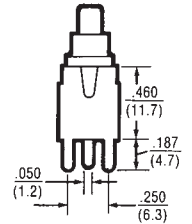

**DP**

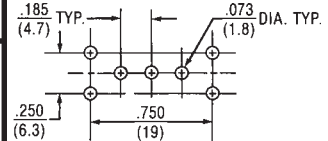
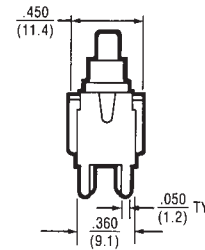

1 Pole P.C. Mounting

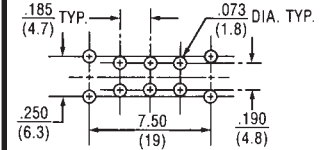

2 Pole P.C. Mounting

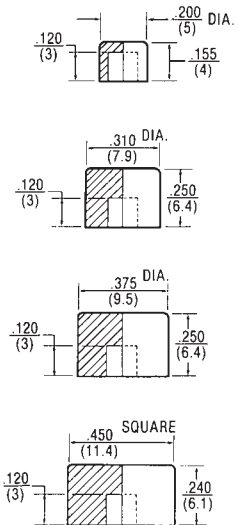

Basic P/N	Terminal Type	Poles	Cap Size	Cap Color	Contact Material-Type
PS	72 - PC Mounted 82 - PC Mounted	1 - One ① 2 - Two ①	0 - No Cap 1 - .200 Dia. 2 - .375 Dia. 3 - .450 Sq. 4 - .310 Dia.	0 - No Cap 1 - Black 2 - White 3 - Red	B - Gold/Nickel/Brass ② G - Gold/Nickel/Silver ① ② Q - Coin Silver ①

① Single pole circuit rated 5 amps, double pole circuit rated 1 amp.  
② Ratings are 0.4 VA — 28 VAC or DC.

**ORDERING EXAMPLES:**

PS72-100Q= (PC mounted 5 amp.) One-pole No Cap No Color Coin Silver Contacts  
P S 72 - 1 0 0 Q

PS82-221B= (PC mounted 0.4 VA) Two-pole .375 Dia. Black Cap Gold/Nickel/Brass Contacts  
P S 82 - 2 2 1 B

**SPECIFICATIONS**

**Contact Rating** — Letter codes G and Q (1 Pole) 5 amp resistive @ 125 VAC (U.L. recognized, CSA certified) or 5 amp resistive @ 28 VDC. (2 pole) 1 amp resistive @ 125 VAC (U.L. recognized, CSA certified) or 1 amp resistive @ 28 VDC.  
 Letter codes B and G — (1 and 2 Poles) 0.4 Volt-amps (VA) maximum @ 28 V maximum (AC or DC).  
**Contact Resistance** — 50 milliohms maximum.  
**Insulation Resistance** — 1,000 megohms minimum.  
**Dielectric Strength** — 1,000 volts RMS minimum at sea level.  
**Electrical Life** — 60,000 cycles minimum at full load-resistive.  
**Maximum Allowable Installation Force on Plunger** — 10 pounds.  
 Multi-pole contacts do not make and break simultaneously.

**MATERIALS**

**Case** — Diallyl Phthalate.  
**Bushing** — Brass, nickel plated.  
**Housing** — Stainless steel.  
**Plunger** — Thermoplastic.  
**Common Contact** — Refer to contact material table above.  
**Center & End Contact** — Refer to contact material table above.

Description	P/N	Color
Small Cap .200	W-KN-16	Black
	W-KN-16A	White
	W-KN-16B	Red
Medium Cap .310	W-KN-32	Black
	W-KN-32A	White
	W-KN-32B	Red
Large Cap .375	W-KN-17	Black
	W-KN-17A	White
	W-KN-17B	Red
Square Cap .450	W-KN-18	Black
	W-KN-18A	White
	W-KN-18B	Red

**Printed Circuit Terminal**



**Sensitive Snap-Action Pushbutton Switches — P.C. Terminals (Momentary Action)**

**PS SERIES** 5 AMP. (S.P.)  
1 AMP (D.P.)  
0.4 VA

**VERTICAL P.C. MOUNT (.630 x .750 BRACKET)**

**PS73 (LONG BUSHING)**

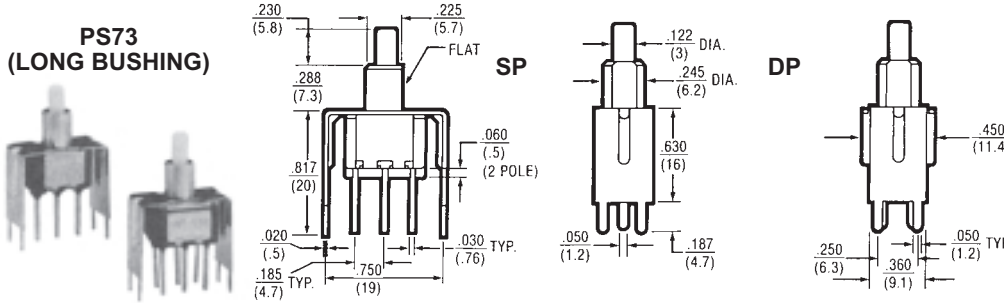

**PS83 (SHORT BUSHING)**

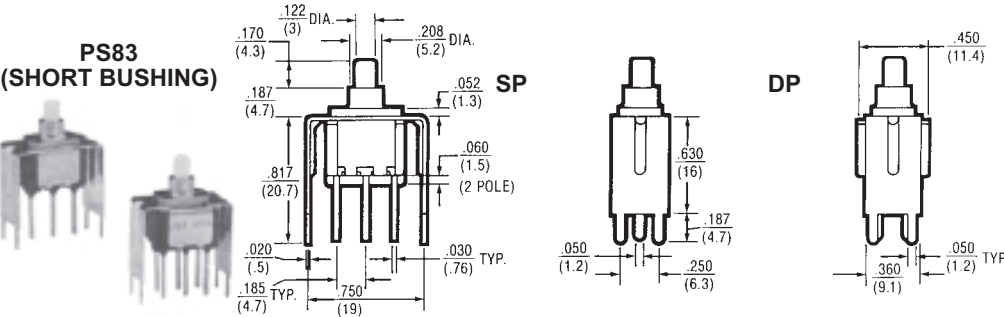

Basic P/N	Terminal Type	Poles	Cap Size	Cap Color	Contact Material-Type
PS	73 - PC Mounted	1 - One	0 - No Cap	0 - No Cap	B - Gold/Nickel/Brass ②
	83 - PC Mounted	2 - Two	1 - .200 Dia.	1 - Black	G - Gold/Nickel/Silver ①②
			2 - .375 Dia.	2 - White	Q - Coin Silver ②
			3 - .450 Sq.	3 - Red	

- ① Single pole circuit rated 5 amps, double pole circuit rated 1 amp.
- ② Ratings are 0.4 VA — 28 VAC or DC.

**ORDERING EXAMPLES:**

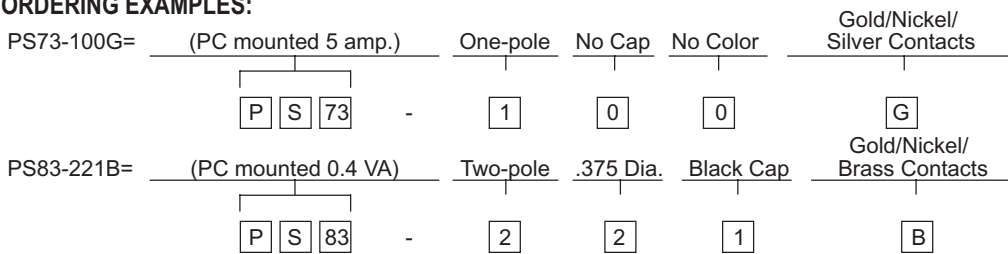

**SPECIFICATIONS**

**Contact Rating** — Letter codes G and Q (1 Pole) 5 amp resistive @ 125 VAC (U.L. recognized, CSA certified) or 5 amp resistive @ 28 VDC. (2 pole) 1 amp resistive @ 125 VAC (U.L. recognized, CSA certified) or 1 amp resistive @ 28 VDC.  
**Letter codes B and G** — (1 and 2 Poles) 0.4 Volt-amps (VA) maximum @ 28 V maximum (AC or DC).  
**Contact Resistance** — 50 milliohms maximum.  
**Insulation Resistance** — 1,000 megohms minimum.  
**Dielectric Strength** — 1,000 volts RMS minimum at sea level.  
**Electrical Life** — 60,000 cycles minimum at full load-resistive.  
**Maximum Allowable Installation Force on Plunger** — 10 pounds.  
 Multi-pole contacts do not make and break simultaneously.

**MATERIALS**

**Case** — Diallyl Phthalate.  
**Bushing** — Brass, nickel plated.  
**Housing** — Stainless steel.  
**Plunger** — Thermoplastic.  
**Common Contact** — Refer to contact material table above.  
**Center & End Contact** — Refer to contact material table above.

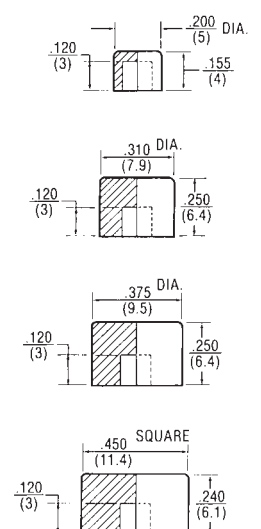
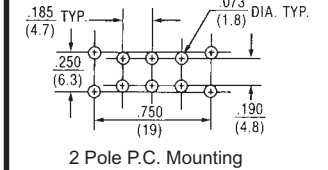
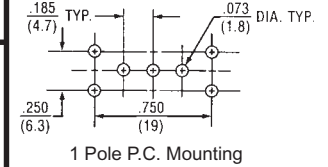

Description	P/N	Color
Small Cap .200	W-KN-16	Black
	W-KN-16A	White
	W-KN-16B	Red
Medium Cap .310	W-KN-32	Black
	W-KN-32A	White
	W-KN-32B	Red
Large Cap .375	W-KN-17	Black
	W-KN-17A	White
	W-KN-17B	Red
Square Cap .450	W-KN-18	Black
	W-KN-18A	White
	W-KN-18B	Red

**Printed Circuit Terminal**





**Sensitive Snap-Action Pushbutton Switches — Solder and P.C. Terminals (Momentary Action)**

**PS SERIES** 5 AMP. (S.P.)  
1 AMP. (D.P.)  
0.4 VA

**SNAP-IN MOUNT**

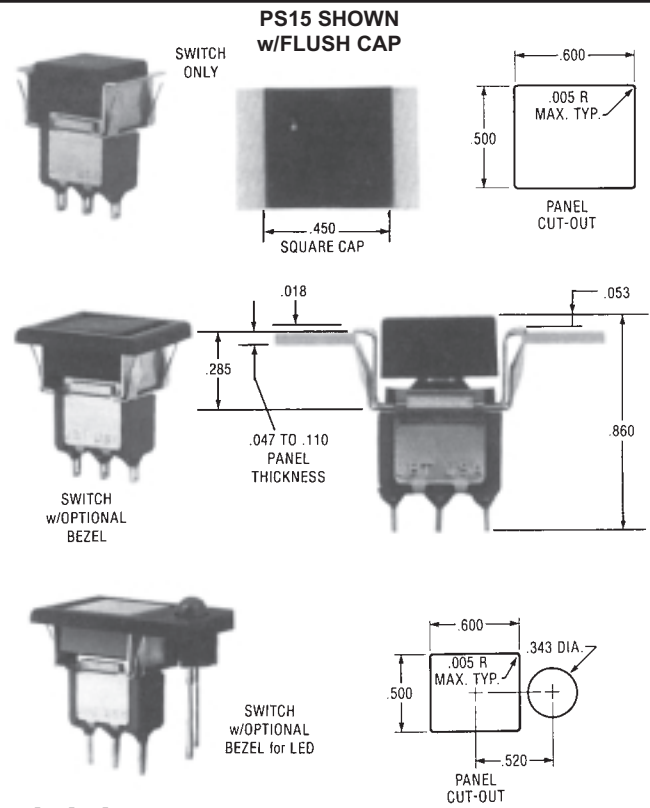

**LED Not Included**

Basic P/N	Cap Configuration Terminal-Rating	Poles	Cap Size	Cap Color	Optional Features	
					Bezel Color & Type	Contact Material-Type
PS	14 - Raised Cap Solder Lug	1 - One ① 2 - Two ①	0 - No Cap 1 - .450 Sq.	0 - No Cap 1 - White 2 - Black 3 - Red	1 - White 2 - Black 3 - Red 4 - Black or LED	B - Gold/Nickel/Brass ②
	15 - Flush Cap ③ Solder Lug					G - Gold/Nickel/Silver ① ②
	16 - Raised Cap PC Terminals					Q - Coin Silver ①
	17 - Flush Cap ③ PC Terminals					

① Single pole circuit rated 5 amps, double pole circuit rated 1 amp.

② Ratings are 0.4 VA — 28 BAC or DC.

③ Flush cap is flush to bezel, not to mounting bracket.

**EXAMPLES:**

PS14-100Q = Raised Cap, Solder Lug Terminals, 5 Amp, Single Pole, No Cap, Coin Silver Contacts

PS14-1134B = Raised Cap, Solder Lug Terminals, 0.4 VA Rating, Single Pole, .450 Square Red Cap, Black Bezel for LED, Gold/Brass Contact Material

**SPECIFICATIONS**

**Contact Rating** — Letter codes G and Q (1 Pole) 5 amp resistive @ 125 VAC (U.L. recognized, CSA certified) or 5 amp resistive @ 28 VDC. (2 pole) 1 amp resistive @ 125 VAC (U.L. recognized, CSA certified) or 1 amp resistive @ 28 VDC.

Letter codes B and G — (1 and 2 Poles) 0.4 Volt-amps (VA) maximum @ 28 V maximum (AC or DC).

**Contact Resistance** — 50 milliohms maximum.

**Insulation Resistance** — 1,000 megohms minimum.

**Dielectric Strength** — 1,000 volts RMS minimum at sea level.

**Electrical Life** — 60,000 cycles minimum at full load-resistive.

**Maximum Allowable Installation Force on Plunger** — 10 pounds. Multi-pole contacts do not make and break simultaneously.

**MATERIALS**

**Case** — Diallyl Phthalate.

**Bushing** — Brass, nickel plated.

**Housing** — Stainless steel.

**Plunger** — Thermoplastic.

**Pushbutton Cap** — Molded nylon.

**Bezel** — Molded nylon.

**Common Contact** — Refer to contact material table above.

**Center & End Contact** — Refer to contact material table above.

**Solder Lug Terminal**

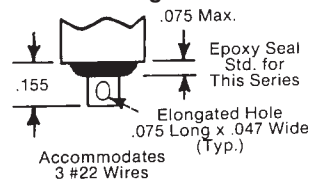

**PC Terminal**

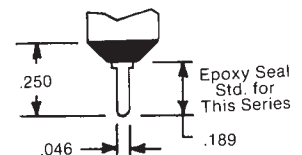

**Sensitive Snap-Action Pushbutton Switches — Solder and P.C. Terminals (Momentary Action)**

**APPROXIMATE DIMENSIONS (For Optional Bezel Types Shown on Page 12)**

**OPTIONAL BEZEL TYPE 1, 2, 3 (SEE TABLE)**  
PS14 Shown w/Raised Cap

Catalog No.	Color
W-BZ-12	Black
W-BZ-12A	White
W-BZ-12B	Red

**OPTIONAL BEZEL TYPE 1, 2, 3 (SEE TABLE)**  
PS15 Shown w/Flush Cap

Catalog No.	Color
W-BZ-12	Black
W-BZ-12A	White
W-BZ-12B	Red

**OPTIONAL BEZEL TYPE 4 FOR LED**  
PS14 Shown w/Raised Cap

LED (.200 DIA.) SNAPS SECURELY INTO BEZEL. HEIGHT DEPENDS ON LED USED

SWITCHES SUPPLIED WITHOUT LED LAMPS.

Catalog No.	Color
W-BZ-15	Black

**OPTIONAL BEZEL TYPE 4 FOR LED**  
PS17 Shown w/Flush Cap

LED (.200 DIA.) SNAPS SECURELY INTO BEZEL. HEIGHT DEPENDS ON LED USED

SWITCHES SUPPLIED WITHOUT LED LAMPS.

Catalog No.	Color
W-BZ-15	Black

**OPTIONAL MOUNTING CLIP (For Use With PS14 Thru PS17 Series Only)**

- For thick plastic panel mount applications (.094" - .125" thick)
- For availability consult Electroswitch.