

GaAs pHEMT MMIC 1 WATT POWER AMPLIFIER, DC - 22 GHz



Typical Applications

The HMC797LP5E is ideal for:

- Test Instrumentation
- Microwave Radio & VSAT
- Military & Space
- Telecom Infrastructure
- Fiber Optics

Features

- High P1dB Output Power: 28 dBm
- High Psat Output Power: 29.5 dBm
- High Gain: 13.5 dB
- High Output IP3: 39 dBm
- Supply Voltage: +10 V @ 400 mA
- 50 Ohm Matched Input/Output
- 32 Lead 5x5 mm SMT Package: 25 mm²

Functional Diagram

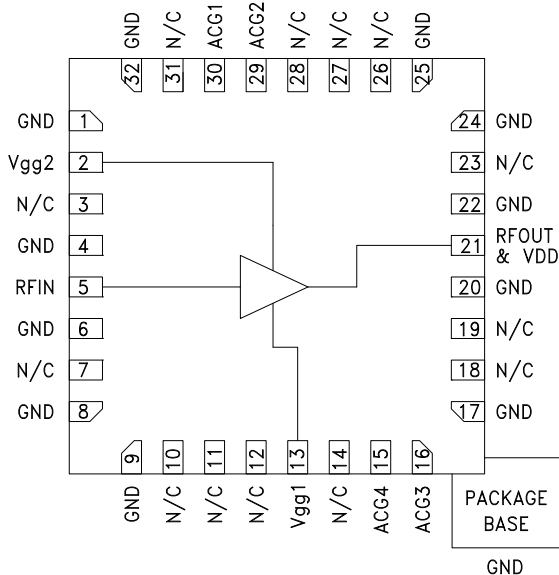

General Description

The HMC797LP5E is a GaAs MMIC pHEMT Distributed Power Amplifier which operates between DC and 22 GHz. The amplifier provides 13.5 dB of gain, 39 dBm output IP3 and +28 dBm of output power at 1 dB gain compression while requiring 400 mA from a +10 V supply. This versatile PA exhibits a positive gain slope from 4 to 20 GHz making it ideal for EW, ECM, Radar and test equipment applications. The HMC797LP5E amplifier I/Os are internally matched to 50 Ohms facilitating integration into multi-chip-modules (MCMs), is packaged in a leadless QFN 5x5 mm surface mount package, and requires no external matching components.

Electrical Specifications, $T_A = +25^\circ\text{C}$, $V_{dd} = +10\text{V}$, $V_{gg2} = +3.5\text{V}$, $I_{dd} = 400\text{mA}^*$

Parameter	Min.	Typ.	Max.	Min.	Typ.	Max.	Min.	Typ.	Max.	Units
Frequency Range	DC - 12			12 - 18			18 - 22			GHz
Gain	11	12.5		11	13.5		11	13.5		dB
Gain Flatness		±0.7			±0.5			±0.5		dB
Gain Variation Over Temperature		0.012			0.008			0.008		dB/°C
Input Return Loss		13			15			15		dB
Output Return Loss		12			16			13		dB
Output Power for 1 dB Compression (P1dB)	26	28		25	27		23.5	25.5		dBm
Saturated Output Power (Psat)		29.5			29			27		dBm
Output Third Order Intercept (IP3)		39			37			35		dBm
Noise Figure		3.5			4			6		dB
Supply Current (Idd) (Vdd= 10V, Vgg1= -0.8V Typ.)		400	440		400	440		400	440	mA

* Adjust Vgg1 between -2 to 0 V to achieve Idd = 400 mA typical.



**GaAs pHEMT MMIC
1 WATT POWER AMPLIFIER, DC - 22 GHz**

Gain & Return Loss

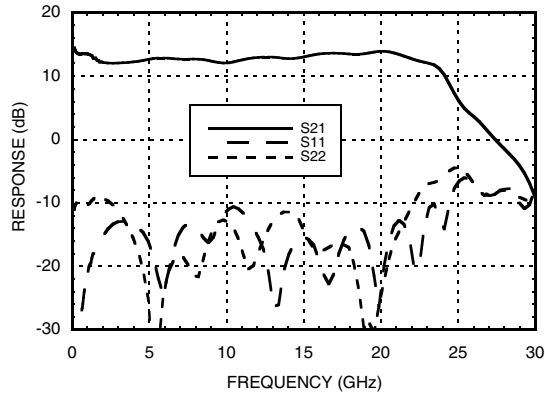

Gain vs. Temperature

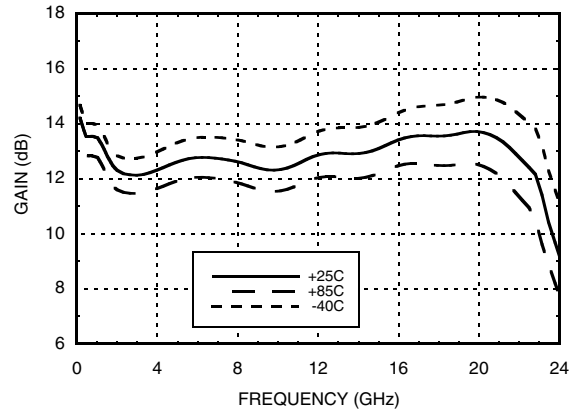

Input Return Loss vs. Temperature

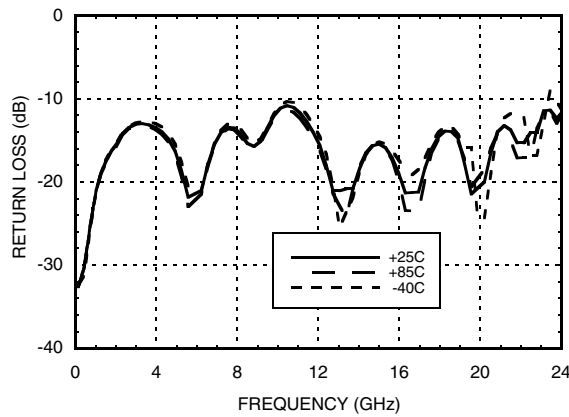

Output Return Loss vs. Temperature

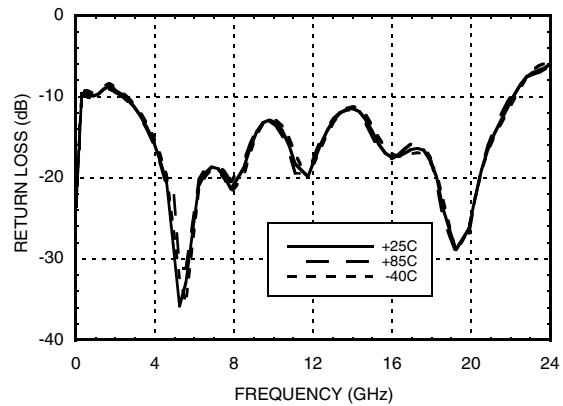

Low Frequency Gain & Return Loss

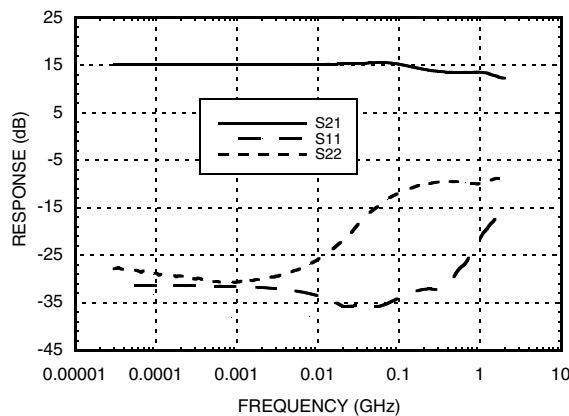

Noise Figure vs. Temperature

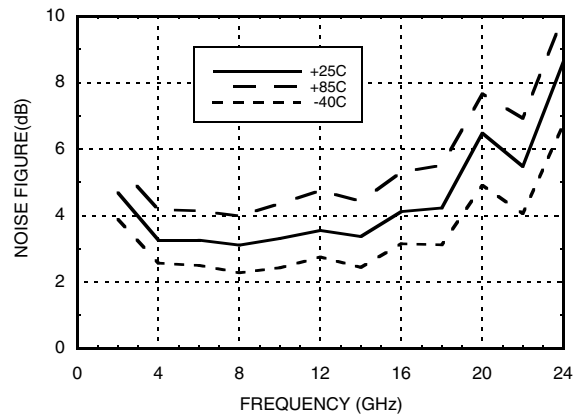

Information furnished by Analog Devices is believed to be accurate and reliable. However, no responsibility is assumed by Analog Devices for its use, nor for any infringements of patents or other rights of third parties that may result from its use. Specifications subject to change without notice. No license is granted by implication or otherwise under any patent or patent rights of Analog Devices. Trademarks and registered trademarks are the property of their respective owners.

For price, delivery, and to place orders: Analog Devices, Inc., One Technology Way, P.O. Box 9106, Norwood, MA 02062-9106 Phone: 781-329-4700 • Order online at www.analog.com Application Support: Phone: 1-800-ANALOG-D



**GaAs pHEMT MMIC
1 WATT POWER AMPLIFIER, DC - 22 GHz**

P1dB vs. Temperature

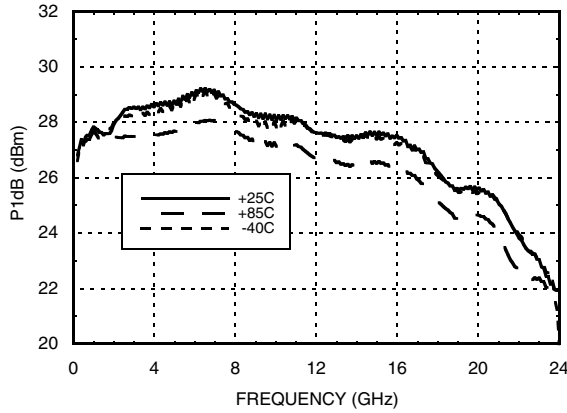

P1dB vs. Supply Voltage

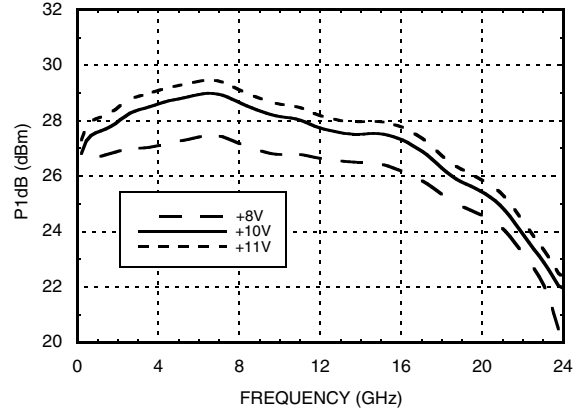

Psat vs. Temperature

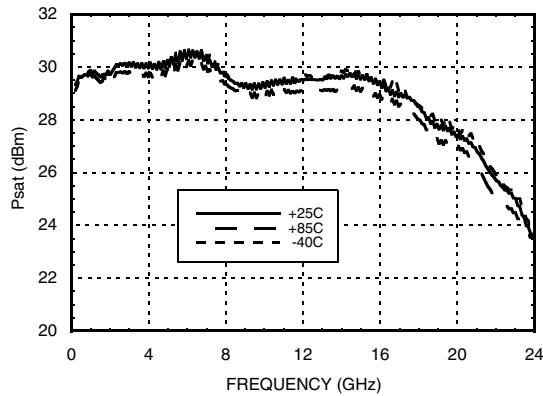

Psat vs. Supply Voltage

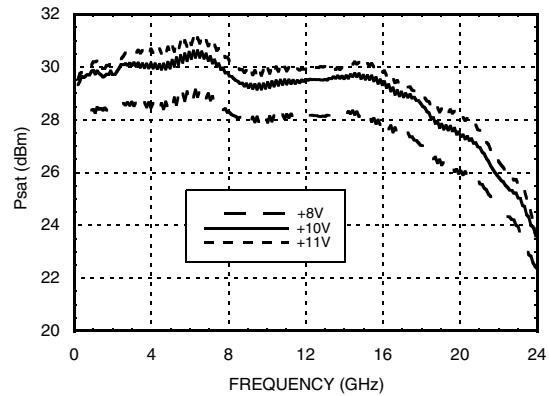

P1dB vs. Supply Current

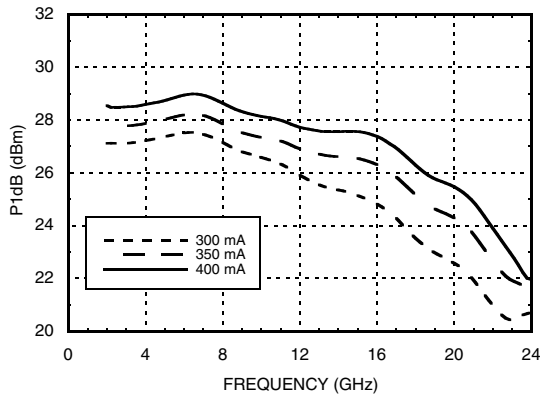

Psat vs. Supply Current

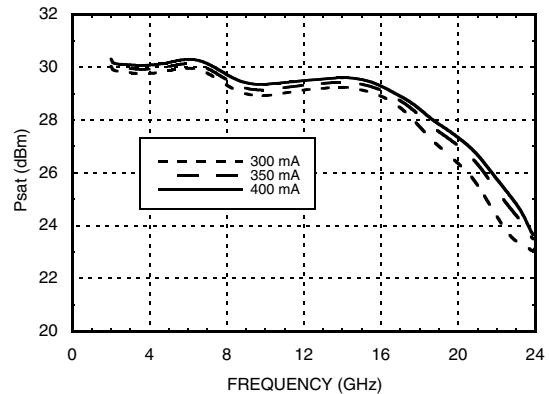

Information furnished by Analog Devices is believed to be accurate and reliable. However, no responsibility is assumed by Analog Devices for its use, nor for any infringements of patents or other rights of third parties that may result from its use. Specifications subject to change without notice. No license is granted by implication or otherwise under any patent or patent rights of Analog Devices. Trademarks and registered trademarks are the property of their respective owners.

For price, delivery, and to place orders: Analog Devices, Inc., One Technology Way, P.O. Box 9106, Norwood, MA 02062-9106 Phone: 781-329-4700 • Order online at www.analog.com Application Support: Phone: 1-800-ANALOG-D

**GaAs pHEMT MMIC
1 WATT POWER AMPLIFIER, DC - 22 GHz**



**Output IP3 vs.
Temperature @ Pout = 18 dBm / Tone**

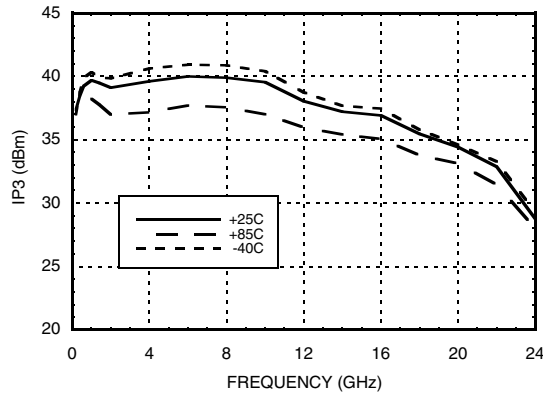

**Output IP3 vs.
Supply Voltage @ Pout = 18 dBm / Tone**

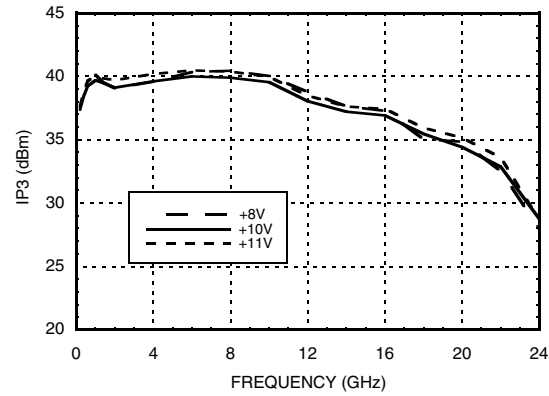

**Output IP3 vs.
Supply Currents @ Pout = 18 dBm / Tone**

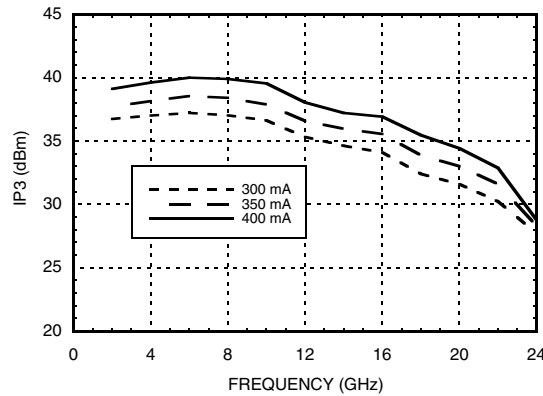

Output IM3 @ Vdd = +8V

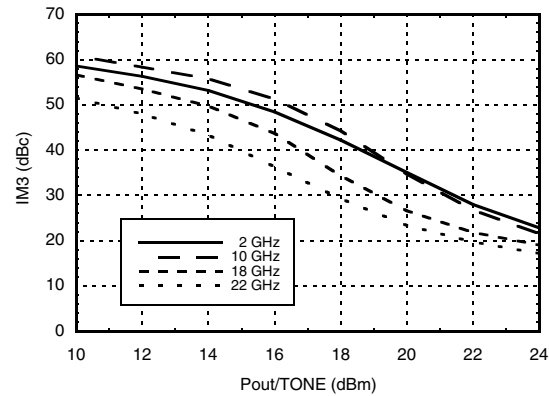

Output IM3 @ Vdd = +10V

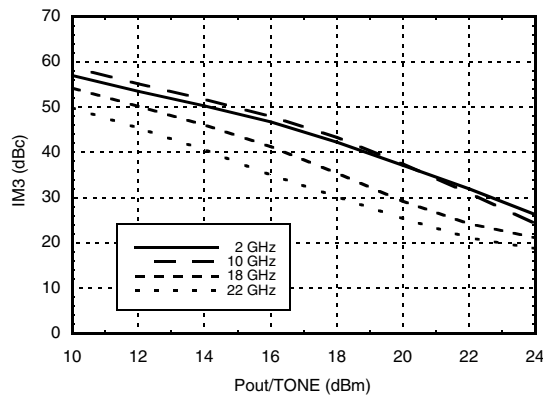

Output IM3 @ Vdd = +11V

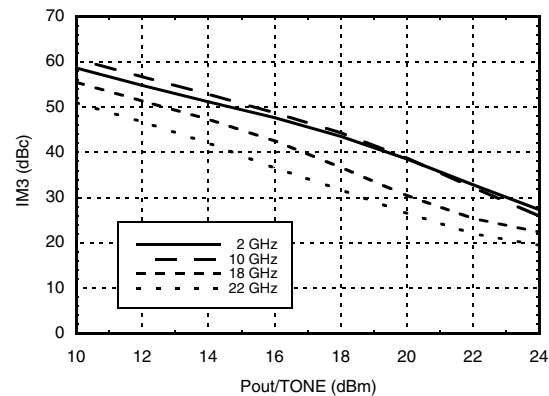

Information furnished by Analog Devices is believed to be accurate and reliable. However, no responsibility is assumed by Analog Devices for its use, nor for any infringements of patents or other rights of third parties that may result from its use. Specifications subject to change without notice. No license is granted by implication or otherwise under any patent or patent rights of Analog Devices. Trademarks and registered trademarks are the property of their respective owners.

For price, delivery, and to place orders: Analog Devices, Inc., One Technology Way, P.O. Box 9106, Norwood, MA 02062-9106 Phone: 781-329-4700 • Order online at www.analog.com Application Support: Phone: 1-800-ANALOG-D



**GaAs pHEMT MMIC
1 WATT POWER AMPLIFIER, DC - 22 GHz**

Reverse Isolation vs. Temperature

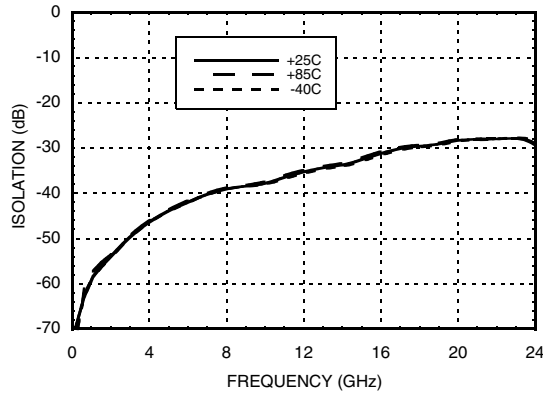

Power Compression @ 10 GHz

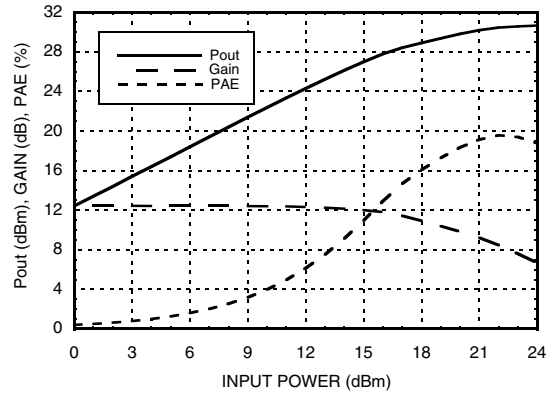

Gain & Power vs. Supply Current @ 10 GHz

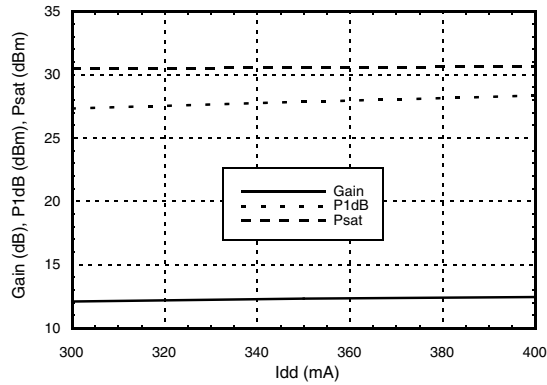

Gain & Power vs. Supply Voltage @ 10 GHz

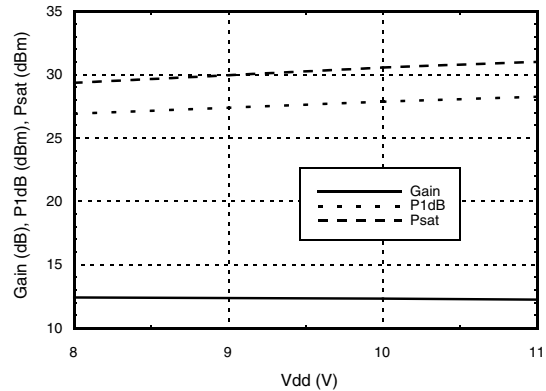

Power Dissipation

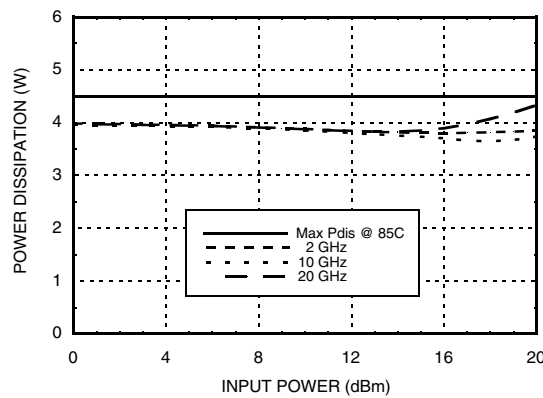

Information furnished by Analog Devices is believed to be accurate and reliable. However, no responsibility is assumed by Analog Devices for its use, nor for any infringements of patents or other rights of third parties that may result from its use. Specifications subject to change without notice. No license is granted by implication or otherwise under any patent or patent rights of Analog Devices. Trademarks and registered trademarks are the property of their respective owners.

For price, delivery, and to place orders: Analog Devices, Inc., One Technology Way, P.O. Box 9106, Norwood, MA 02062-9106 Phone: 781-329-4700 • Order online at www.analog.com Application Support: Phone: 1-800-ANALOG-D



**GaAs pHEMT MMIC
1 WATT POWER AMPLIFIER, DC - 22 GHz**

Second Harmonics vs. Temperature
@ Pout = 18 dBm, Vdd = 10V & Vgg = 3.5V

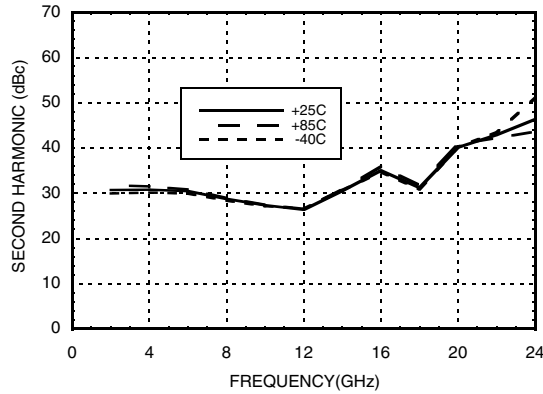

Second Harmonics vs. Vdd @ Pout = 18 dBm, Idd = 400 mA [1]

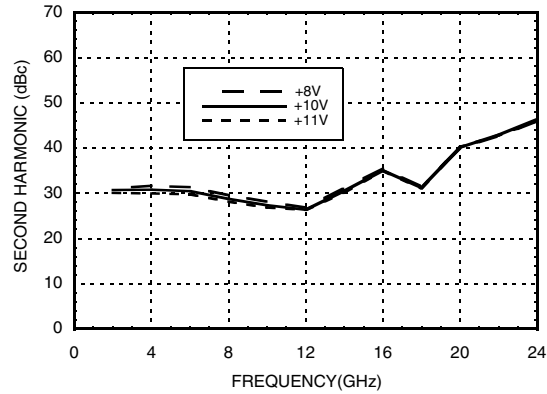

Second Harmonics vs. Idd @ Pout = 18 dBm, Vgg2 = 3.5V

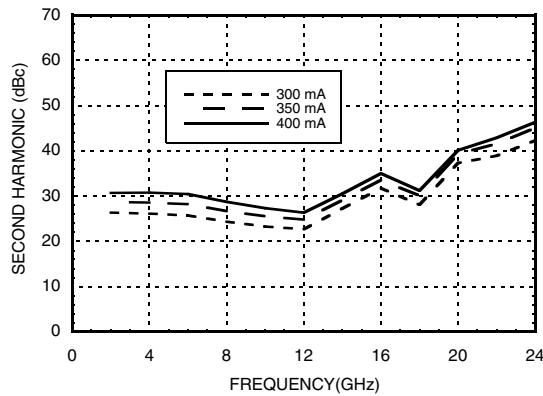

Second Harmonics vs. Pout
Vdd = 10V & Vgg = 3.5V & Idd = 400 mA

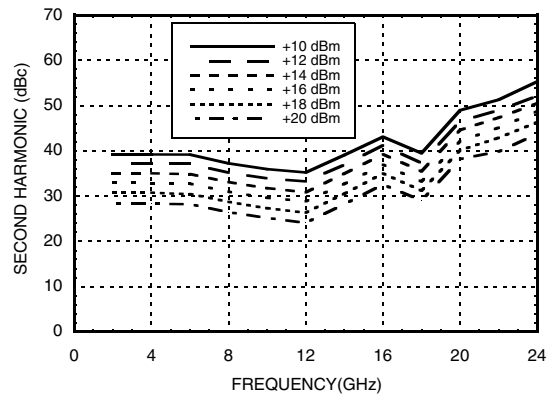

Information furnished by Analog Devices is believed to be accurate and reliable. However, no responsibility is assumed by Analog Devices for its use, nor for any infringements of patents or other rights of third parties that may result from its use. Specifications subject to change without notice. No license is granted by implication or otherwise under any patent or patent rights of Analog Devices. Trademarks and registered trademarks are the property of their respective owners.

For price, delivery, and to place orders: Analog Devices, Inc., One Technology Way, P.O. Box 9106, Norwood, MA 02062-9106
Phone: 781-329-4700 • Order online at www.analog.com
Application Support: Phone: 1-800-ANALOG-D

GaAs pHEMT MMIC 1 WATT POWER AMPLIFIER, DC - 22 GHz



Absolute Maximum Ratings

Nominal Drain Supply to GND	+12.0 V
Gate Bias Voltage (V _{gg1})	-3.0 to 0 Vdc
Gate Bias Current (I _{gg1})	< +10 mA
Gate Bias Voltage (V _{gg2})	+2.0 V to (V _{dd} - 6.5 V)
Gate Bias Current (I _{gg2})	< +10 mA
Continuous P _{diss} (T = 85 °C) (derate 69 mW/°C above 85 °C)	4.5 W
RF Input Power	+27 dBm
Output Power into VSWR >7:1	+29 dBm
Storage Temperature	-65 to 150 °C
Max Peak Reflow Temperature	260 °C
ESD Sensitivity (HBM)	Class 1A

Reliability Information

Junction Temperature to Maintain 1 Million Hour MTTF	150 °C
Nominal Junction Temperature (T=85 °C, V _{dd} = 10 V)	144 °C
Thermal Resistance (channel to ground paddle)	14.6 °C/W
Operating Temperature	-40 to +85 °C

9

AMPLIFIERS - LINEAR & POWER - SMT



ELECTROSTATIC SENSITIVE DEVICE
OBSERVE HANDLING PRECAUTIONS

Typical Supply Current vs. V_{dd}

V _{dd} (V)	I _{dd} (mA)
+9	400
+10	400
+11	400

Outline Drawing

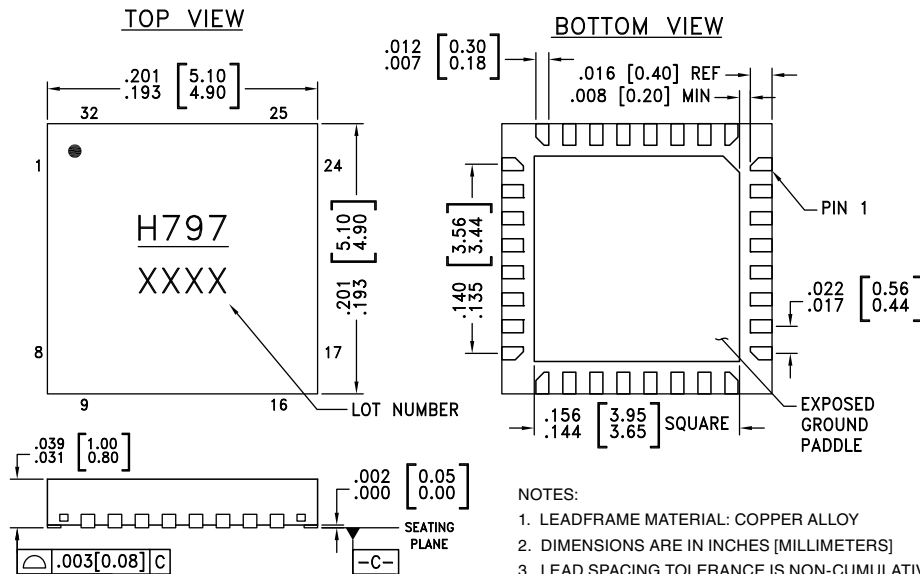

Package Information

Part Number	Package Body Material	Lead Finish	MSL Rating	Package Marking ^[1]
HMC797LP5E	RoHS-compliant Low Stress Injection Molded Plastic	100% matte Sn	MSL1 ^[2]	H79Z XXXX

[1] 4-Digit lot number XXXX

[2] Max peak reflow temperature of 260 °C

Information furnished by Analog Devices is believed to be accurate and reliable. However, no responsibility is assumed by Analog Devices for its use, nor for any infringements of patents or other rights of third parties that may result from its use. Specifications subject to change without notice. No license is granted by implication or otherwise under any patent or patent rights of Analog Devices. Trademarks and registered trademarks are the property of their respective owners.

For price, delivery, and to place orders: Analog Devices, Inc., One Technology Way, P.O. Box 9106, Norwood, MA 02062-9106
Phone: 781-329-4700 • Order online at www.analog.com
Application Support: Phone: 1-800-ANALOG-D

**GaAs pHEMT MMIC
1 WATT POWER AMPLIFIER, DC - 22 GHz**
Pin Descriptions

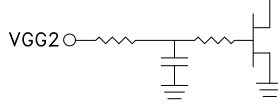
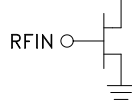
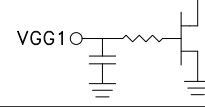
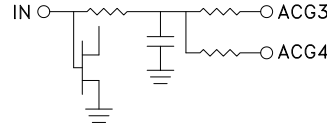
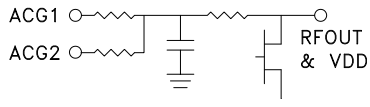
Pin Number	Function	Description	Interface Schematic
1, 4, 6, 8, 9, 17, 20, 22, 24, 25, 32 Package Bottom	GND	These pins & exposed ground paddle must be connected to RF/DC ground.	
2	VGG2	Gate control 2 for amplifier. Attach bypass capacitor per application circuit herein. For nominal operation +3.5V should be applied to Vgg2.	
3, 7, 10 - 12, 14, 18, 19, 23, 26 - 28, 31	N/C	No connection required. These pins may be connected to RF/DC ground without affecting performance.	
5	RFIN	This pad is DC coupled and matched to 50 Ohms. Blocking capacitor is required.	
13	VGG1	Gate control 1 for amplifier. Attach bypass capacitor per application circuit herein. Please follow "MMIC Amplifier Biasing Procedure" application note.	
15	ACG4	Low frequency termination. Attach bypass capacitor per application circuit herein.	
16	ACG3		
21	RFOUT & VDD	RF output for amplifier. Connect DC bias (Vdd) network to provide drain current (Idd). See application circuit herein.	
29	ACG2	Low frequency termination. Attach bypass capacitor per application circuit herein.	
30	ACG1		

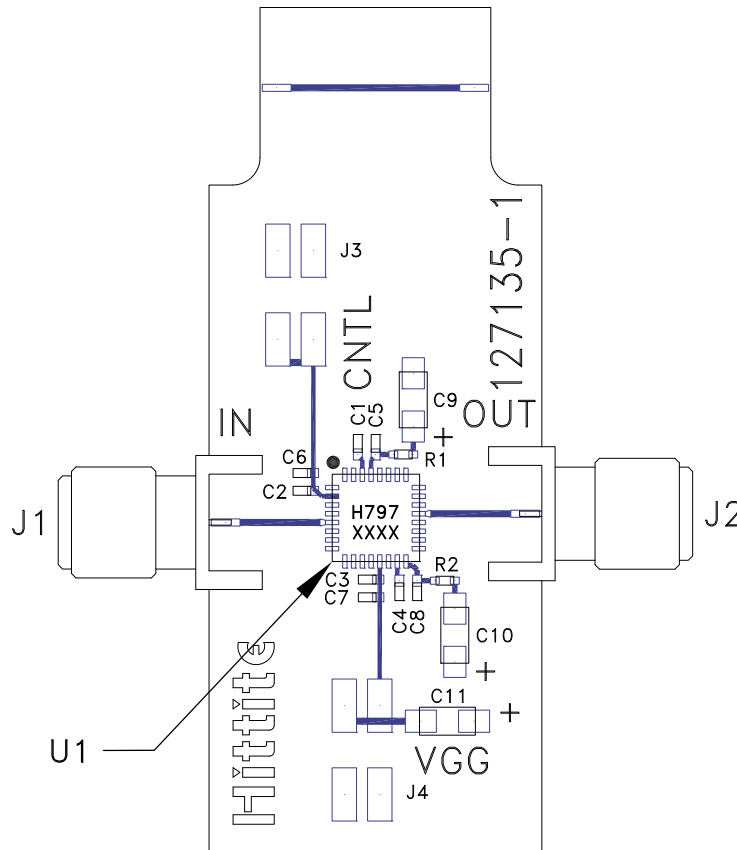
**GaAs pHEMT MMIC
1 WATT POWER AMPLIFIER, DC - 22 GHz**
Evaluation PCB

List of Materials for Evaluation PCB 130784 [1]

Item	Description
J1, J2	SMA Connectors
J3, J4	DC Pins
C1 - C4	100 pF Capacitor, 0402 Pkg.
C5, C8	10 kpF Capacitor, 0402 Pkg.
C9 - C11	4.7 μ F Capacitor, Tantalum
R1, R2	0 OHM Resistor, 0402 Pkg
U1	HMC797LP5E Power Amplifier
PCB [2]	127135 Evaluation PCB

[1] Reference this number when ordering complete evaluation PCB

[2] Circuit Board Material: Rogers 4350 or Arlon FR4

The circuit board used in the application should use RF circuit design techniques. Signal lines should have 50 Ohm impedance while the package ground leads and exposed paddle should be connected directly to the ground plane similar to that shown. A sufficient number of via holes should be used to connect the top and bottom ground planes. The evaluation board should be mounted to an appropriate heat sink. The evaluation circuit board shown is available from Hittite upon request.



**GaAs pHEMT MMIC
1 WATT POWER AMPLIFIER, DC - 22 GHz**

Application Circuit

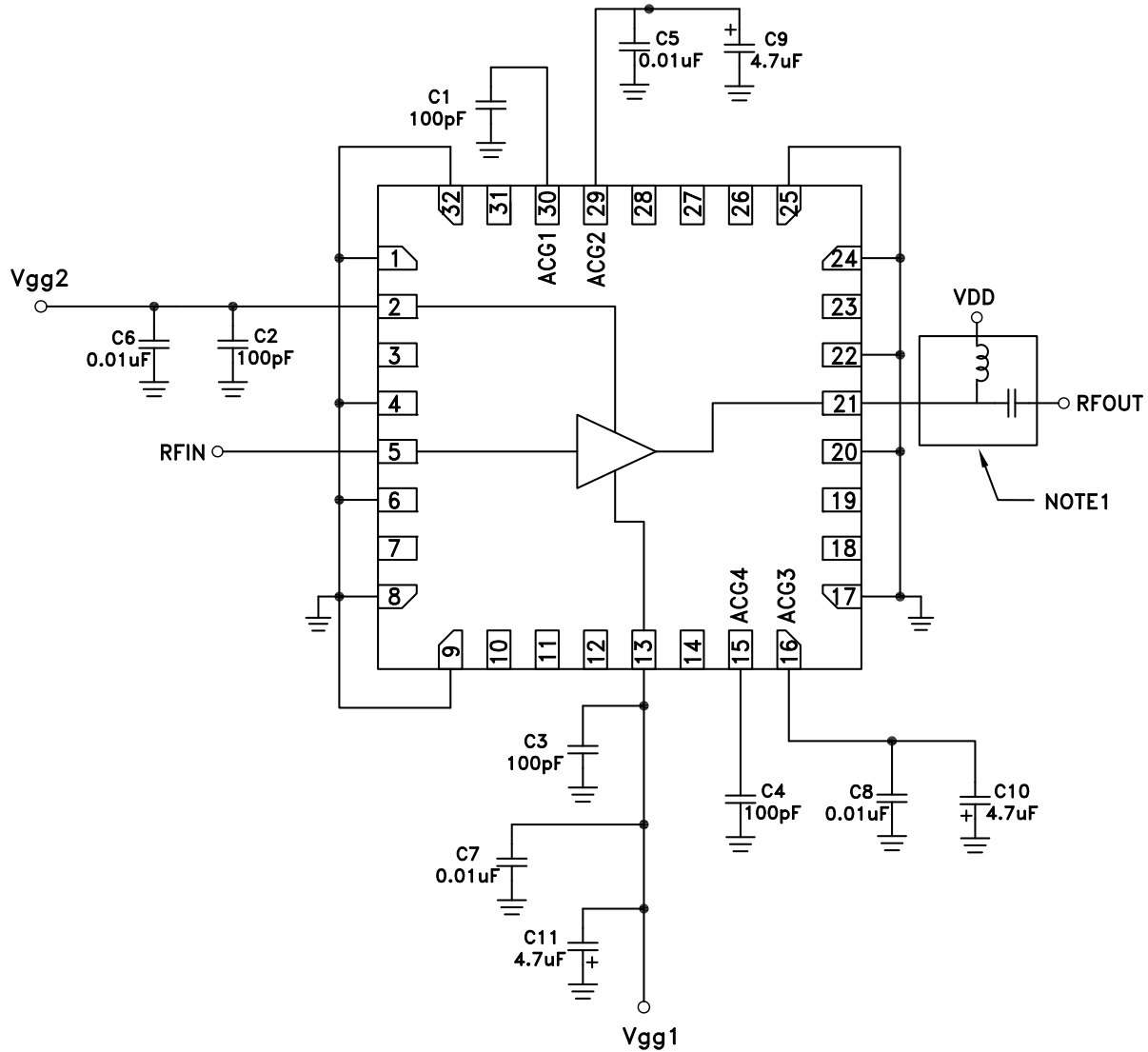

NOTE 1: Drain Bias (Vdd) must be applied through a broadband bias tee or external bias network.

Information furnished by Analog Devices is believed to be accurate and reliable. However, no responsibility is assumed by Analog Devices for its use, nor for any infringements of patents or other rights of third parties that may result from its use. Specifications subject to change without notice. No license is granted by implication or otherwise under any patent or patent rights of Analog Devices. Trademarks and registered trademarks are the property of their respective owners.

For price, delivery, and to place orders: Analog Devices, Inc., One Technology Way, P.O. Box 9106, Norwood, MA 02062-9106 Phone: 781-329-4700 • Order online at www.analog.com Application Support: Phone: 1-800-ANALOG-D