

MULTI-LAYER CERAMIC CHIP INDUCTORS

LCCI Series

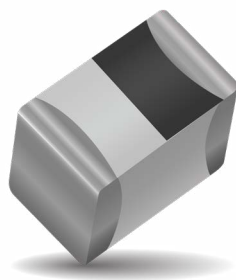

APPLICATIONS

High Frequency Applications:

- Mobile Communications
- WLAN
- PHS
- EMI Counter measure in High Frequency Circuits
- Computer Communication

FEATURES

For high frequency applications

- Standard EIA sizes 0201 (0603), 0402 (1005), 0603 (1608)
- Lead-free RoHS compliant parts
- Tight tolerance in physical dimensions
- Surface mounting applicability (Supports reflow soldering condition)
- Tight Inductance Tolerance, Excellent Q and Guaranteed SRF range
- High product quality and outstanding reliability. (Ceramic integrated structure)
- Operating temperature -40°C to +85°C

HOW TO ORDER

LC	CI	0402	K	101	G	T	A	R
Family	Series	Size	Tolerance	Inductance	Style	Termination	Special	Packaging
LC = Chip Inductor		0201 0402 0603	G = 2% H = 3% J = 5% K = 10% B = 0.1nH C = 0.2nH S = 0.3nH	3N9 = 3.9nH 39N = 39nH R39 = 390nH	G = Standard	T = Sn Plating	A = Standard	R = 7" Reel

DIMENSIONS

Size	L	W	T	A	
				Min	Max
0201	0.60 ± 0.03 (0.024 ± 0.001)	0.30 ± 0.03 (0.012 ± 0.001)	0.30 ± 0.03 (0.012 ± 0.001)	0.10 (0.004)	0.20 (0.008)
0402	1.00 ± 0.10 (0.040 ± 0.004)	0.50 ± 0.10 (0.020 ± 0.004)	0.50 ± 0.10 (0.020 ± 0.004)	0.10 (0.004)	0.30 (0.012)
0603	1.60 ± 0.15 (0.063 ± 0.006)	0.80 ± 0.15 (0.031 ± 0.006)	0.80 ± 0.15 (0.031 ± 0.006)	0.20 (0.008)	0.60 (0.024)

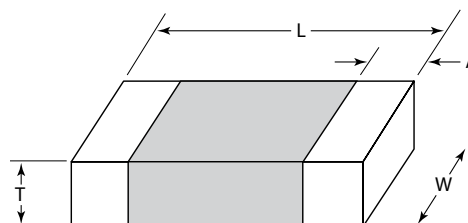

AVAILABLE INDUCTANCE VALUE AND TOLERANCE

Size Code	Available Inductance	Inductance Ranges	Standard Tolerance
LCCI0201	0.3nH - 39nH	0.3nH-0.9nH	B=±0.1nH
		1.0nH-6.2nH	B=±0.1nH, C=±0.2nH, S= ±0.3 nH
		6.8nH - 27nH	H=±3%, J=±5%
		33nH-39nH	J=±5%
LCCI0402	0.3nH - 150nH	0.3nH-0.8nH	B=±0.1nH
		1.0nH-6.2nH	B=±0.1nH, C=±0.2nH, S= ±0.3 nH
		6.8nH-68nH	G=±2%, H=±3%, J=±5%
		82nH-150nH	J=±5%
LCCI0603	1.0 nH - 270 nH	1.0nH-5.6nH	S= ± 0.3nH
		6.8nH-270nH	J=±5%

MULTI-LAYER CERAMIC CHIP INDUCTORS



LCCI Series

ELECTRICAL CHARACTERISTICS

Case Size 0201

Ordering Code	L (nH)	L Tolerance	Q Min.	L,Q TEST FREQ. (MHz)	SRF (MHz) MIN.	DC Resistance (Ω) MAX.	I _{rms} (mA) MAX.
0N3	0.3	B=±0.1nH	4	100	10,000	0.07	850
0N4	0.4	B=±0.1nH	4	100	10,000	0.07	850
0N5	0.5	B=±0.1nH	4	100	10,000	0.08	800
0N6	0.6	B=±0.1nH	4	100	10,000	0.08	800
0N7	0.7	B=±0.1nH	4	100	10,000	0.09	750
0N8	0.8	B=±0.1nH	4	100	10,000	0.1	750
0N9	0.9	B=±0.1nH	4	100	10,000	0.1	750
1N0	1	B=±0.1nH, C=±0.2nH, S= ±0.3 Nh	4	100	10,000	0.14	600
1N1	1.1	B=±0.1nH, C=±0.2nH, S= ±0.3 Nh	4	100	10,000	0.14	600
1N2	1.2	B=±0.1nH, C=±0.2nH, S= ±0.3 Nh	4	100	10,000	0.14	600
1N3	1.3	B=±0.1nH, C=±0.2nH, S= ±0.3 Nh	4	100	10,000	0.14	600
1N4	1.4	B=±0.1nH, C=±0.2nH, S= ±0.3 Nh	4	100	10,000	0.18	550
1N5	1.5	B=±0.1nH, C=±0.2nH, S= ±0.3 Nh	4	100	10,000	0.18	550
1N6	1.6	B=±0.1nH, C=±0.2nH, S= ±0.3 Nh	4	100	10,000	0.18	500
1N7	1.7	B=±0.1nH, C=±0.2nH, S= ±0.3 Nh	4	100	10,000	0.19	500
1N8	1.8	B=±0.1nH, C=±0.2nH, S= ±0.3 Nh	4	100	10,000	0.19	500
1N9	1.9	B=±0.1nH, C=±0.2nH, S= ±0.3 Nh	4	100	10,000	0.2	450
2N0	2	B=±0.1nH, C=±0.2nH, S= ±0.3 Nh	4	100	10,000	0.2	450
2N1	2.1	B=±0.1nH, C=±0.2nH, S= ±0.3 Nh	4	100	10,000	0.2	450
2N2	2.2	B=±0.1nH, C=±0.2nH, S= ±0.3 Nh	4	100	10,000	0.22	450
2N3	2.3	B=±0.1nH, C=±0.2nH, S= ±0.3 Nh	4	100	10,000	0.22	450
2N4	2.4	B=±0.1nH, C=±0.2nH, S= ±0.3 Nh	4	100	10,000	0.24	450
2N5	2.5	B=±0.1nH, C=±0.2nH, S= ±0.3 Nh	4	100	10,000	0.24	450
2N6	2.6	B=±0.1nH, C=±0.2nH, S= ±0.3 Nh	4	100	10,000	0.25	450
2N7	2.7	B=±0.1nH, C=±0.2nH, S= ±0.3 Nh	5	100	10,000	0.25	450
2N9	2.9	B=±0.1nH, C=±0.2nH, S= ±0.3 Nh	5	100	9,500	0.28	450
3N0	3	B=±0.1nH, C=±0.2nH, S= ±0.3 Nh	5	100	9,500	0.28	450
3N1	3.1	B=±0.1nH, C=±0.2nH, S= ±0.3 Nh	5	100	9,500	0.28	450
3N2	3.2	B=±0.1nH, C=±0.2nH, S= ±0.3 Nh	5	100	9,500	0.3	450
3N3	3.3	B=±0.1nH, C=±0.2nH, S= ±0.3 Nh	5	100	9,500	0.3	450
3N4	3.4	B=±0.1nH, C=±0.2nH, S= ±0.3 Nh	5	100	8,000	0.3	400
3N5	3.5	B=±0.1nH, C=±0.2nH, S= ±0.3 Nh	5	100	8,000	0.3	400
3N6	3.6	B=±0.1nH, C=±0.2nH, S= ±0.3 Nh	5	100	8,000	0.3	400
3N7	3.7	B=±0.1nH, C=±0.2nH, S= ±0.3 Nh	5	100	8,000	0.3	400
3N8	3.8	B=±0.1nH, C=±0.2nH, S= ±0.3 Nh	5	100	6,500	0.3	400
3N9	3.9	B=±0.1nH, C=±0.2nH, S= ±0.3 Nh	5	100	6,500	0.3	400
4N3	4.3	B=±0.1nH, C=±0.2nH, S= ±0.3 Nh	5	100	6,500	0.4	350
4N7	4.7	B=±0.1nH, C=±0.2nH, S= ±0.3 Nh	5	100	6,500	0.4	350
5N1	5.1	B=±0.1nH, C=±0.2nH, S= ±0.3 Nh	5	100	6,500	0.4	350
5N6	5.6	B=±0.1nH, C=±0.2nH, S= ±0.3 Nh	5	100	6,000	0.4	350
6N2	6.2	B=±0.1nH, C=±0.2nH, S= ±0.3 Nh	5	100	6,000	0.44	300
6N8	6.8	H=±3%, J=±5%	5	100	5,400	0.5	300
7N5	7.5	H=±3%, J=±5%	5	100	4,800	0.53	300
8N2	8.2	H=±3%, J=±5%	5	100	4,800	0.55	250
9N1	9.1	H=±3%, J=±5%	5	100	4,500	0.62	250
10N	10	H=±3%, J=±5%	5	100	4,500	0.65	250
12N	12	H=±3%, J=±5%	5	100	3,700	0.7	250
15N	15	H=±3%, J=±5%	5	100	2,200	0.8	250
18N	18	H=±3%, J=±5%	5	100	2,200	0.9	200

MULTI-LAYER CERAMIC CHIP INDUCTORS

LCCI Series

ELECTRICAL CHARACTERISTICS (CONTINUED)

Case Size 0201

Ordering Code	L (nH)	L Tolerance	Q Min.	L,Q TEST FREQ. (MHz)	SRF (MHz) MIN.	DC Resistance (Ω) MAX.	I _{rms} (mA) MAX.
22N	22	H=±3%, J=±5%	5	100	2,000	1.2	150
27N	27	H=±3%, J=±5%	4	100	1,800	1.8	140
33N	33	J=±5%	4	100	1,700	2.1	120
39N	39	J=±5%	4	100	1,500	2.4	120

Tolerance: B = ±0.1nH, C = ±0.2nH, S = ±0.3nH, G = ±2%, H = ±3%, J = ±5%, K = ±10%

Measuring Equipment: HP4287+16196C

Measuring Temperature: 25 ± 3°C

Operating Temperature: -40°C to +85°C

0201 L VS Frequency

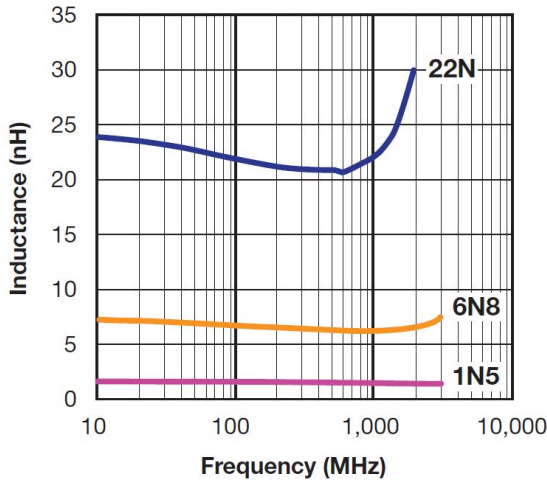

0201 Q VS Frequency

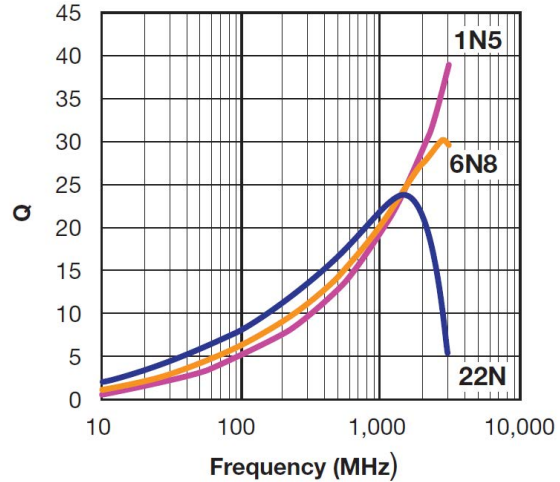

0201 Z VS Frequency

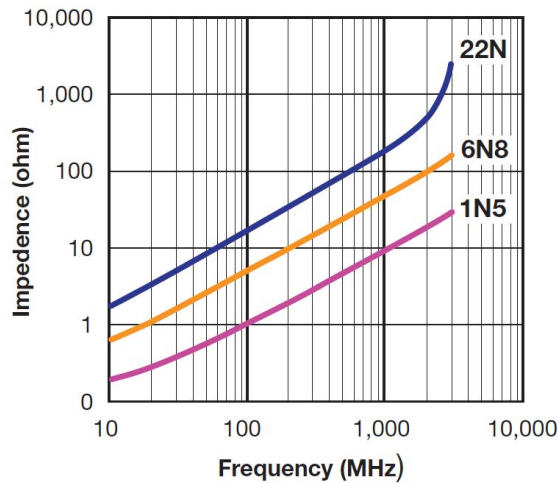

MULTI-LAYER CERAMIC CHIP INDUCTORS



LCCI Series

ELECTRICAL CHARACTERISTICS

Case Size 0402

Ordering Code	L (nH)	L Tolerance	Q Min.	L,Q TEST FREQ. (MHz)	SRF (MHz) MIN.	DC Resistance (Ω) MAX.	I _{rms} (mA) MAX.
0N3	0.3	B=±0.1nH	8	100	10,000	0.08	1000
0N4	0.4	B=±0.1nH	8	100	10,000	0.08	1000
0N5	0.5	B=±0.1nH	8	100	10,000	0.08	1000
0N6	0.6	B=±0.1nH	8	100	10,000	0.08	1000
0N7	0.7	B=±0.1nH	8	100	10,000	0.08	1000
0N8	0.8	B=±0.1nH	8	100	10,000	0.08	1000
1N0	1	B=±0.1nH, C=±0.2nH, S= ±0.3 Nh	8	100	10,000	0.08	1000
1N1	1.1	B=±0.1nH, C=±0.2nH, S= ±0.3 Nh	8	100	10,000	0.08	1000
1N2	1.2	B=±0.1nH, C=±0.2nH, S= ±0.3 Nh	8	100	10,000	0.09	1000
1N3	1.3	B=±0.1nH, C=±0.2nH, S= ±0.3 Nh	8	100	10,000	0.09	1000
1N5	1.5	B=±0.1nH, C=±0.2nH, S= ±0.3 Nh	8	100	10,000	0.1	1000
1N6	1.6	B=±0.1nH, C=±0.2nH, S= ±0.3 Nh	8	100	10,000	0.1	1000
1N8	1.8	B=±0.1nH, C=±0.2nH, S= ±0.3 Nh	8	100	10,000	0.12	900
2N0	2	B=±0.1nH, C=±0.2nH, S= ±0.3 Nh	8	100	10,000	0.12	900
2N2	2.2	B=±0.1nH, C=±0.2nH, S= ±0.3 Nh	8	100	10,000	0.13	900
2N4	2.4	B=±0.1nH, C=±0.2nH, S= ±0.3 Nh	8	100	10,000	0.13	800
2N7	2.7	B=±0.1nH, C=±0.2nH, S= ±0.3 Nh	8	100	6,000	0.16	800
3N0	3	B=±0.1nH, C=±0.2nH, S= ±0.3 Nh	8	100	6,000	0.16	800
3N3	3.3	B=±0.1nH, C=±0.2nH, S= ±0.3 Nh	8	100	6,000	0.16	800
3N6	3.6	B=±0.1nH, C=±0.2nH, S= ±0.3 Nh	8	100	6,000	0.2	700
3N9	3.9	B=±0.1nH, C=±0.2nH, S= ±0.3 Nh	8	100	6,000	0.2	700
4N3	4.3	B=±0.1nH, C=±0.2nH, S= ±0.3 Nh	8	100	6,000	0.2	700
4N7	4.7	B=±0.1nH, C=±0.2nH, S= ±0.3 Nh	8	100	6,000	0.2	700
5N1	5.1	B=±0.1nH, C=±0.2nH, S= ±0.3 Nh	8	100	5,300	0.23	600
5N6	5.6	B=±0.1nH, C=±0.2nH, S= ±0.3 Nh	8	100	4,500	0.23	600
6N2	6.2	B=±0.1nH, C=±0.2nH, S= ±0.3 Nh	8	100	4,500	0.25	600
6N8	6.8	G=±2%, H=±3%, J=±5%	8	100	4,500	0.25	600
7N5	7.5	G=±2%, H=±3%, J=±5%	8	100	4,200	0.28	500
8N2	8.2	G=±2%, H=±3%, J=±5%	8	100	3,700	0.28	500
9N1	9.1	G=±2%, H=±3%, J=±5%	8	100	3,400	0.3	500
10N	10	G=±2%, H=±3%, J=±5%	8	100	3,400	0.3	500
12N	12	G=±2%, H=±3%, J=±5%	8	100	3,000	0.45	400
15N	15	G=±2%, H=±3%, J=±5%	8	100	2,500	0.55	400
18N	18	G=±2%, H=±3%, J=±5%	8	100	2,200	0.65	300
22N	22	G=±2%, H=±3%, J=±5%	8	100	1,900	0.7	300
27N	27	G=±2%, H=±3%, J=±5%	8	100	1,700	0.8	300
33N	33	G=±2%, H=±3%, J=±5%	8	100	1,600	0.9	200
39N	39	G=±2%, H=±3%, J=±5%	8	100	1,200	1	200
47N	47	G=±2%, H=±3%, J=±5%	8	100	1,100	1.1	200
56N	56	G=±2%, H=±3%, J=±5%	8	100	1,000	1.1	200
68N	68	G=±2%, H=±3%, J=±5%	8	100	800	1.2	200
82N	82	J=±5%	8	100	600	1.3	200
R10	100	J=±5%	8	100	600	1.6	200
R12	120	J=±5%	8	100	600	1.6	150
R15	150	J=±5%	8	100	550	3.2	140

MULTI-LAYER CERAMIC CHIP INDUCTORS

LCCI Series

0402 L VS Frequency

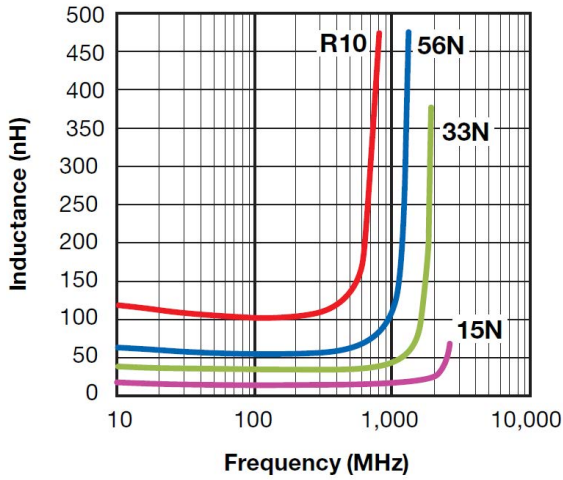

0402 Q VS Frequency

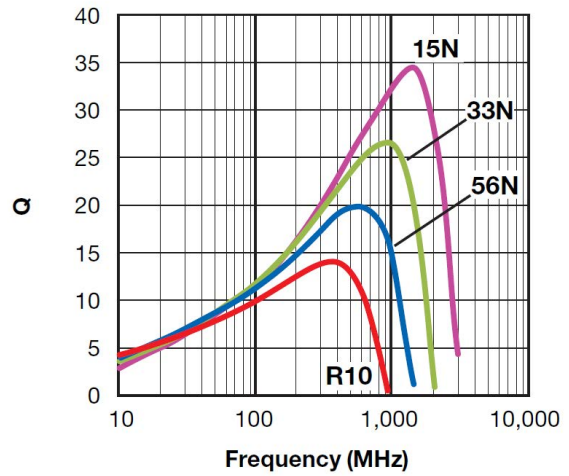

0402 Z VS Frequency

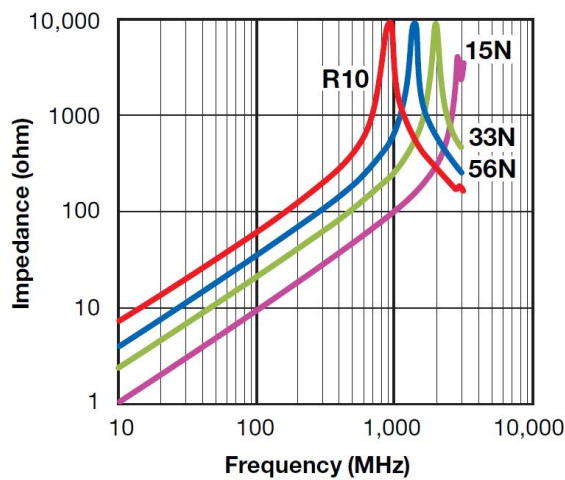

MULTI-LAYER CERAMIC CHIP INDUCTORS



LCCI Series

ELECTRICAL CHARACTERISTICS

Case Size 0603

Ordering Code	L (nH)	L Tolerance	Q Min.	L,Q TEST FREQ. (MHz)	SRF (MHz) MIN.	DC Resistance (Ω) MAX.	I _{rms} (mA) MAX.
1N0	1	S= ± 0.3nH	8	100	10000	0.05	1000
1N2	1.2	S= ± 0.3nH	8	100	10000	0.05	1000
1N5	1.5	S= ± 0.3nH	8	100	10000	0.1	1000
1N8	1.8	S= ± 0.3nH	8	100	10000	0.1	1000
2N2	2.2	S= ± 0.3nH	8	100	8000	0.1	1000
2N7	2.7	S= ± 0.3nH	10	100	7000	0.13	1000
3N3	3.3	S= ± 0.3nH	10	100	6000	0.13	1000
3N9	3.9	S= ± 0.3nH	10	100	6000	0.15	1000
4N7	4.7	S= ± 0.3nH	10	100	5000	0.2	1000
5N6	5.6	S= ± 0.3nH	10	100	4000	0.23	600
6N8	6.8	J=±5%	10	100	4000	0.25	600
8N2	8.2	J=±5%	10	100	3500	0.28	600
10N	10	J=±5%	12	100	3400	0.3	600
12N	12	J=±5%	12	100	2600	0.35	600
15N	15	J=±5%	12	100	2300	0.4	600
18N	18	J=±5%	12	100	2000	0.45	600
22N	22	J=±5%	12	100	1600	0.5	600
27N	27	J=±5%	12	100	1400	0.55	600
33N	33	J=±5%	12	100	1200	0.6	600
39N	39	J=±5%	12	100	1100	0.65	500
47N	47	J=±5%	12	100	900	0.7	500
56N	56	J=±5%	12	100	900	0.75	500
68N	68	J=±5%	12	100	700	0.85	400
82N	82	J=±5%	12	100	600	0.95	300
R10	100	J=±5%	12	100	600	1	300
R12	120	J=±5%	8	50	500	1.2	300
R15	150	J=±5%	8	50	500	1.2	300
R18	180	J=±5%	8	50	400	1.3	300
R22	220	J=±5%	8	50	400	1.5	300
R27	270	J=±5%	8	50	400	1.9	200

MULTI-LAYER CERAMIC CHIP INDUCTORS

LCCI Series

0603 L VS Frequency

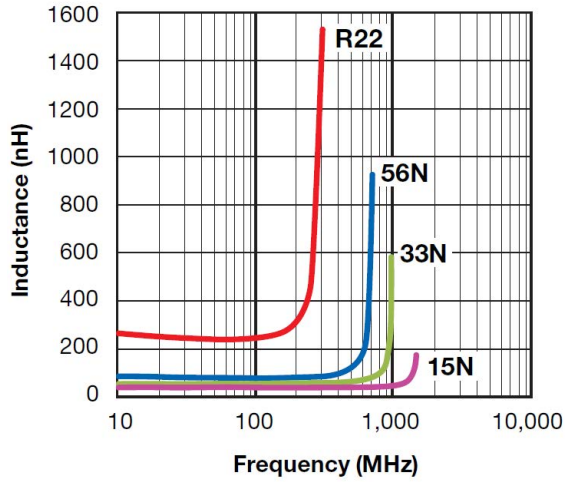

0603 Q VS Frequency

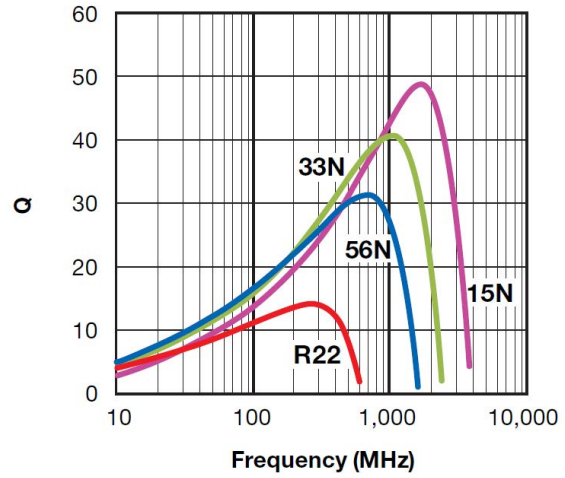

0603 Z VS Frequency

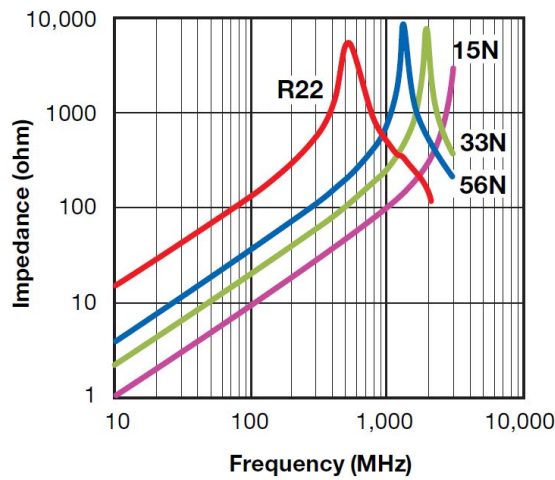

MULTI-LAYER CERAMIC CHIP INDUCTORS

LCCI Series



TEST CONDITION AND REQUIREMENTS

No.	Item	Test Condition	Requirements
1	Inductance	<ul style="list-style-type: none"> Temperature: 25 ± 3°C Relative Humidity: 45 to 75%RH 	Within specified tolerance.
2	Q Value	<ul style="list-style-type: none"> Temperature: 25 ± 3°C Relative Humidity: 45 to 75%RH 	In accordance with electrical specification.
3	DC Resistance	<ul style="list-style-type: none"> Temperature: 25 ± 3°C Relative Humidity: 45 to 75%RH Measuring equipment: HP 4338. 	In accordance with electrical specification.
4	Appearance	Inductors shall be visually inspected for visible evidence of defect.	In accordance with specification.
5	Dimension	Dimension shall be measured with caliper or micrometer	In accordance with dimension specification.
6	Solderability	Immerse a test sample into a methanol solution containing resin and immerse into molten solder of 230 ± 5°C for 5 ± 1 second.	More than 75% of the terminal electrode part shall be covered with fresh solder.
7	Bending Strength	<p>Solder the chip to test jig then apply a force in the direction shown in below. The soldering shall be done with the reflow method and shall be conducted with care so that the soldering is uniform and free of defects such as heat shock.</p>	<ol style="list-style-type: none"> No mechanical damage shall be observed. Rdc-value: to meet the initial Spec.
8	Resistance to Soldering Heat	Immerse a test sample into a methanol solution containing resin, preheat it at 120 to 150°C for 1 minute and immerse into molten solder of 270 ± 5°C for 10 ± 1 second so that both terminal electrodes are completely submerged.	No visible damage. Inductance variation within 10%. Q variation within 20%.
9	Thermal Shock	<p>Solder a test sample to printed circuit board, and conduct 5 cycles of test under the conditions shown as below.</p> <p>0201 & 0402 operating temp. range: -55~125°C 0603 operating temp. range: -40~85°C Cycle: Maximum operating temp. (30 ± 3min)</p>	No visible damage. Inductance variation within 10%. Q variation within 20%.
10	High Humidity State Life Test	Keep a test sample in an atmosphere with a temperature of 40 ± 2°C, 90~95%RH for 500 ± 12 hours. After the removal from test chamber, 2 to 3 hours of recovery under standard condition, and measurement shall be made after 24 ± 2 hrs. of recovery under standard condition.	No visible damage. Inductance variation within 10%. Q variation within 20%.
11	High Humidity Load Life Test	Solder a test sample to printed circuit board then keep the test sample in an atmosphere with a temperature of 40 ± 2°C, 90~95%RH for 500 ± 12 hours while supplying the rated current. After the removal from test chamber, 2 to 3 hours of recovery under standard condition, and measurement shall be made after 24 ± 2 hrs. of recovery under standard condition.	No visible damage. Inductance variation within 10%. Q variation within 20%.
12	High Temperature State Life Test	Keep a test sample in an atmosphere with a temperature of 85 ± 2°C for 500 ± 12 hours. After the removal from test chamber, 2 to 3 hours of recovery under standard condition, and measurement shall be made after 24 ± 2 hrs. of recovery under standard condition.	No visible damage. Inductance variation within 10%. Q variation within 20%.
13	High Temperature Load	Solder a test sample to printed circuit board then keep the test sample in an atmosphere with a temperature of 85 ± 2°C for 500 ± 12 hours while supplying the rated current. After the removal from test chamber, 2 to 3 hours of recovery under standard condition, and measurement shall be made after 24 ± 2 hrs. of recovery under standard condition.	No visible damage. Inductance variation within 10%. Q variation within 20%.

MULTI-LAYER CERAMIC CHIP INDUCTORS

LCCI Series

PACKAGING SPECIFICATIONS

Paper tape specification (0201/0402/0603)

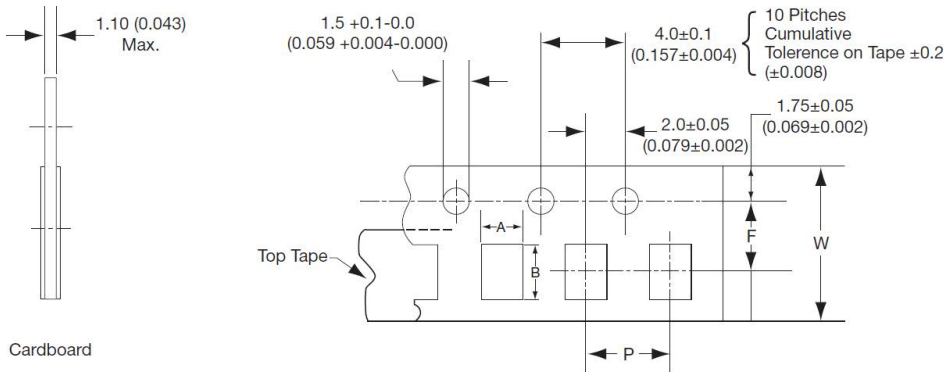

Symbol	Product Size					
	0201		0402		0603	
	Size	Tolerance	Size	Tolerance	Size	Tolerance
A	0.36 (0.015)	± 0.02 (0.001)	0.60 (0.024)	± 0.03 (0.001)	0.98 (0.038)	± 0.03 (0.002)
B	0.66 (0.027)	± 0.02 (0.001)	1.12 (0.044)	± 0.03 (0.001)	1.80 (0.071)	± 0.05 (0.002)
F	3.50 (0.138)	± 0.05 (0.002)	3.50 (0.138)	± 0.05 (0.002)	3.50 (0.138)	± 0.05 (0.002)
P	2.00 (0.079)	± 0.10 (0.004)	2.00 (0.079)	± 0.10 (0.004)	4.00 (0.157)	± 0.10 (0.004)
W	8.00 (0.315)	± 0.20 (0.008)	8.00 (0.315)	± 0.20 (0.008)	8.00 (0.315)	± 0.10 (0.008)

Reel Specifications

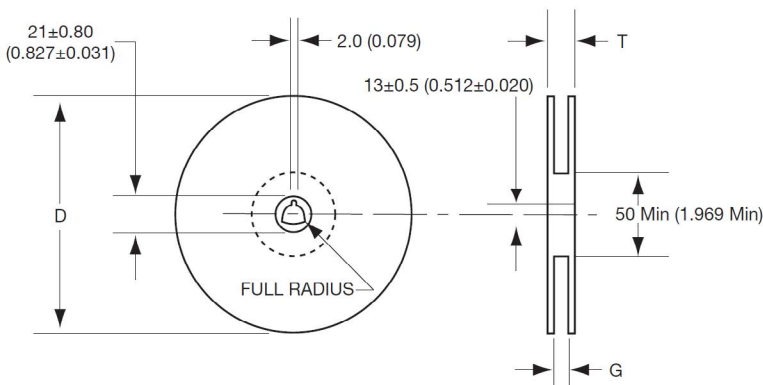

Tape Width	G	T max.	D
8.00 (0.315)	10.0 ± 1.5 (0.394 ± 0.059)	14.5 (0.571)	180 (7.087)

Peel strength of top cover tape

The peel speed shall be about 300 mm/min.

The peel strength of top cover tape shall be between 0.1 to 1.0N.

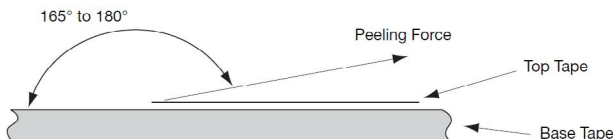

MULTI-LAYER CERAMIC CHIP INDUCTORS

LCCI Series

Quantity per reel:

0201: 15,000 pieces / reel
 0402: 10,000 pieces / reel
 0603: 4,000 pieces / reel

The contents of a box:

0201: 5 reels / box
 0402: 5 reels / box
 0603: 5 reels / box

CAUTIONS

Storage

The chip inductor shall be packaged in carrier tapes.

To keep storage place temperature from +5 to 35°C, humidity from 45 to 70% RH.

The storage atmosphere must be free of gas containing sulfur and chlorine. Also, avoid exposing the product to saline moisture. If the product is exposed to such atmospheres, the terminals will oxidize and solderability will be affected.

The solderability is assured for 12 months from our final inspection date if the above storage condition is followed.

Handling

Chip inductor should be handled with care to avoid contamination or damage. The use of vacuum pick-up or plastic tweezers is recommended for manual placement. Tape and reeled packages are suitable for automatic pick and placement machine.

Recommended Pad Dimensions

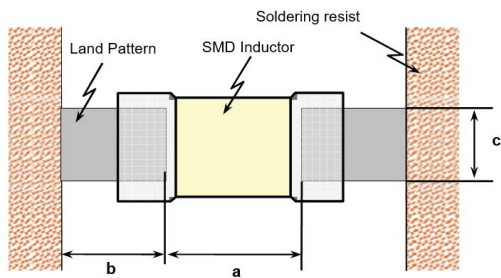

mm (inches)

Size (EIA)	L X W (mm (inches))	a (mm (inches))	b (mm (inches))	c (mm (inches))
0201	0.60 x 0.30 (0.024 x 0.012)	0.15 to 0.35 (0.006 to 0.014)	0.20 to 0.30 (0.008 to 0.012)	0.25 to 0.30 (0.010 to 0.012)
0402	1.00 x 0.50 (0.039 x 0.020)	0.30 to 0.50 (0.012 to 0.020)	0.35 to 0.45 (0.014 to 0.018)	0.40 to 0.50 (0.016 to 0.020)
0603	1.60 x 0.80 (0.063 x 0.031)	0.70 to 1.00 (0.028 to 0.039)	0.60 to 0.80 (0.024 to 0.031)	0.70 to 0.80 (0.028 to 0.031)

Marking

The following item shall be marked on the reel.

1. Manufactures parts number.
2. Manufacturing date code.
3. Manufacturer name.
4. Manufactures lot number.
5. Quantity.

Soldering Profile for SMT Process with SnPb Solder Paste

The rate of preheat should not exceed 4°C/sec. and a target of 2°C/sec. is preferred. Ceramic chip components should be preheated to within 100 to 130°C of the soldering.

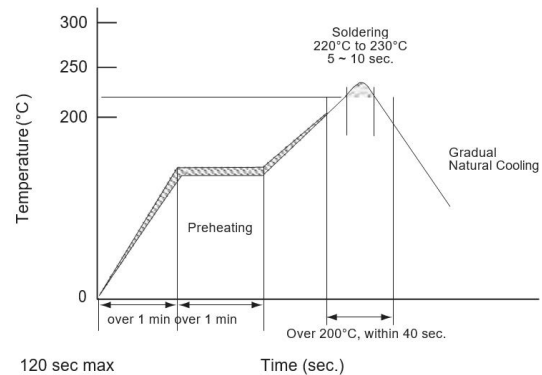

Soldering Profile for SMT Process with Lead Free Solder Paste

The rate of preheat should not exceed 4°C/sec. and a target of 2°C/sec. is preferred. Ceramic chip components should be preheated to within 100 to 130°C of the soldering.

