



## 1. 2-Mic Slider Overview

Vesper have designed a 2-microphone slider board to connect directly to any system using Plug in Power, 2 wire microphone interfaces. It allows users to quickly create 2 microphone systems to form a microphone array or external stereo recording mics, where the distance between the mics can be varied from 10mm up to 120mm. The Vesper VM1001 piezo MEMS microphone offers great advantages over old ECM microphones and conventional capacitive MEMS microphones such as:

- Dust resistant to IP5x
- Water resistant to IPx7
- Ultra-fast startup <200uS
- Stiction immunity
- Stable and consistent performance over time, meaning no degradation for array applications

### 1.1 Microphone Slider Board Design

The 2-Mic slider board consists of:

- VM1001f microphones mounted to mini pcb with 2-wire interface circuit
- 3.5mm connector with cable
- PCB with slider channel

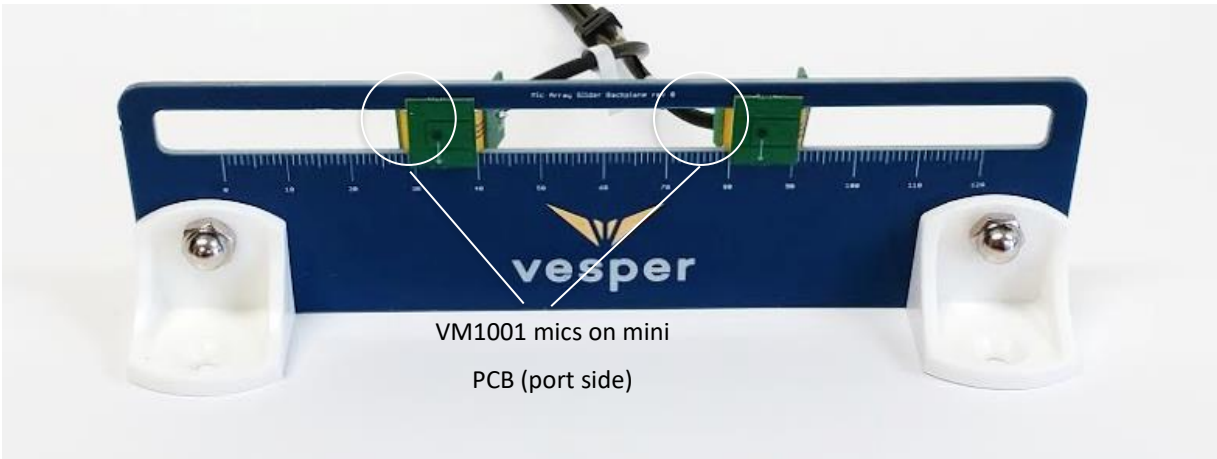

Figure 1. Front view of 2 Mic Slider with microphone ports facing

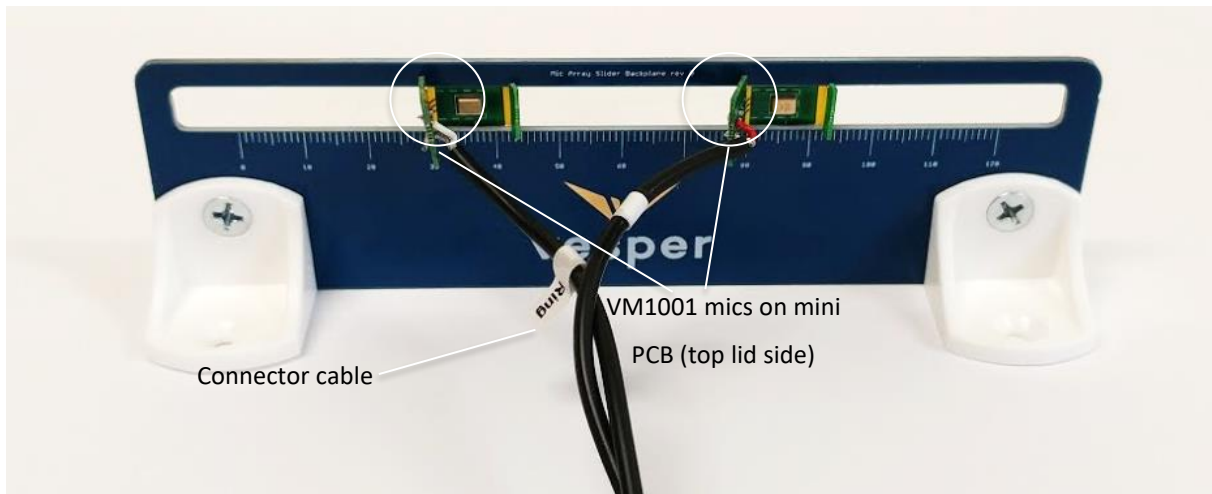

Figure 2. Rear view of 2 Mic Slider with microphone lids facing and cabling visible

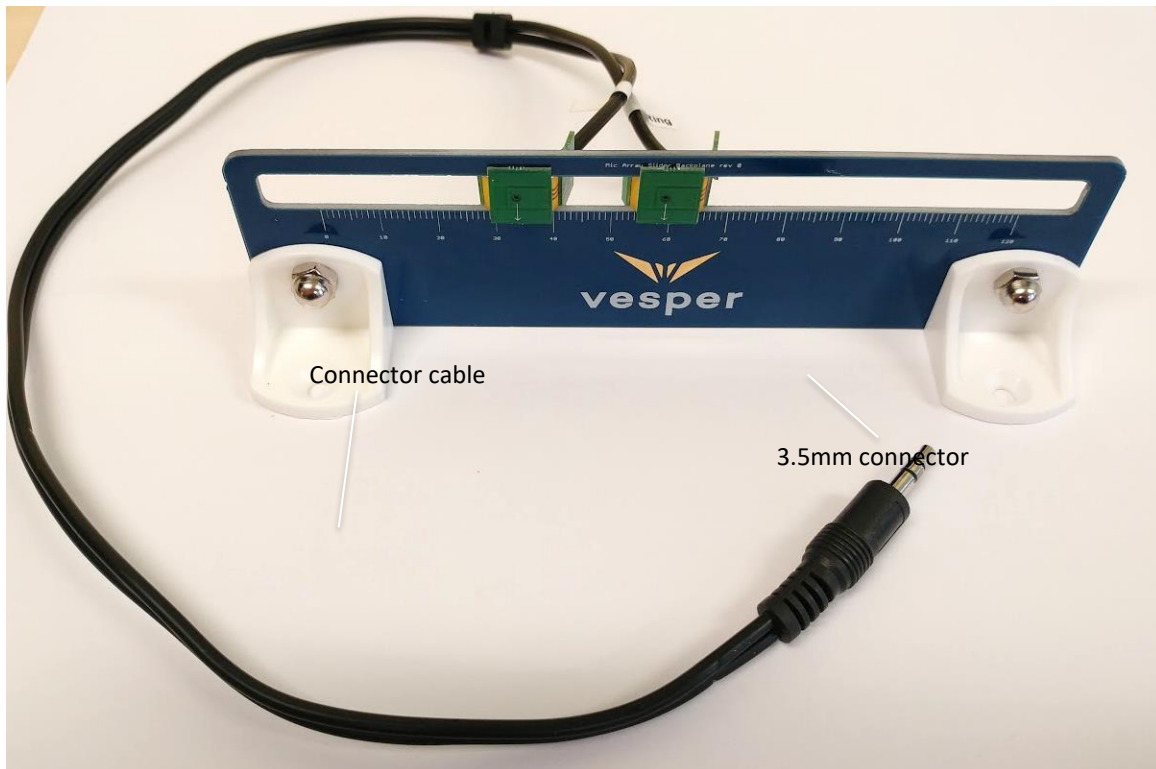

Figure 3. Slider board with 3.5mm connector visible

## 2. Setup

### 2.1 Connection to Evaluation Kits or Recording Systems

The 3.5mm connector from the 2 Mic Slider plugs directly into any system with a Plug in Power interface. The audio L and R channels are routed to each microphone respectively.

### 2.2 Microphone Slider Operation

Each mini PCB is a unique combination of flex and solid PCB to hold the VM1001 in place when in the mic slider but allow it to be easily moved by the user. There are 3 solid PCBs

with 2 flex PCBs connecting them, with PCB “wings” or tabs on the outside of the microphone. The VM1001 is mounted on the middle solid PCB.

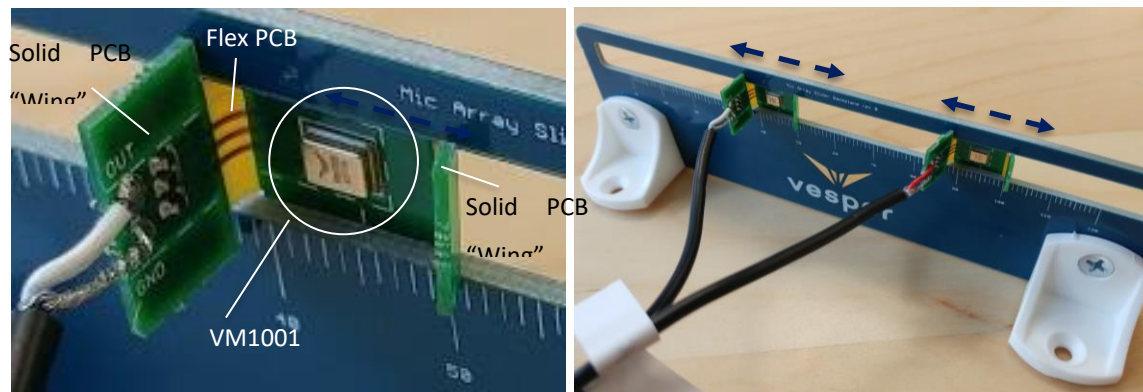

Figure 4. Slider with Solid and Flex PCBs (left), Intended slider operation (right)

To move the mic in the slider the user grabs each mic by the PCB “wing” (tab) on either side of the mic. By pinching the wings together, the user reduces the tension between the boards which holds it in place on the slider, allowing it to slide side to side. The user should not try to move the mini PCB by pulling on the wing as this the tension will not be reduced and the flex pcb could tear with excessive strain in trying to overcome it.

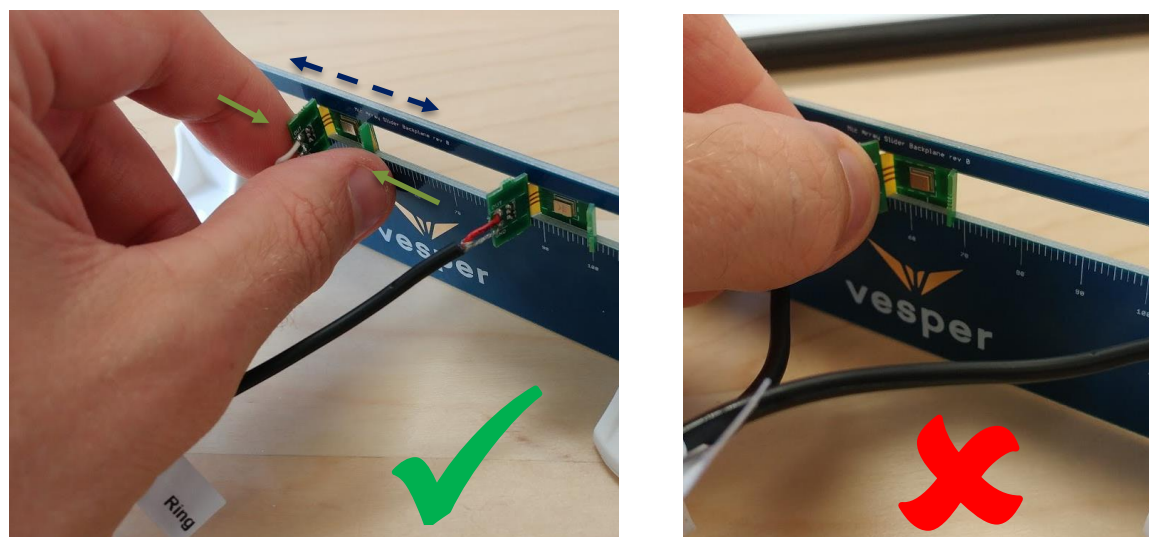

Figure 5. Pinching PCB wings to allow movement (left), Pulling the tab is not recommended (right)

## 3. Use of Mics without slider

After characterizing the performance of the mics at a given distance the user may wish to use them in a prototype housing for their industrial design.

### 3.1 Removal of mics from slider

The mics can be removed from the slider by creating an angle with the shorter pcb “wing” so that it can get in between slider rails and sliding it out of them. The other solid PCBs can now be rotated to be removed from the slider.

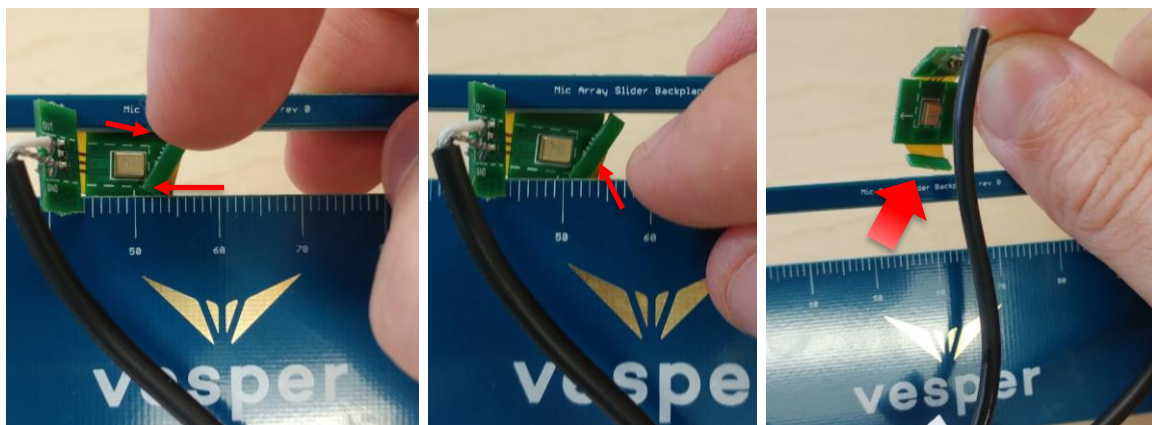

Figure 6. Creating angle (left) allowing wing to slide out (center) and then the rest (right)

## 4. Other Information

### 4.1 Schematic

There is a 3 wire to 2 wire adapter circuit built on the PCB to allow the mics to be connected to Plug in Power via the 3.5mm connector.

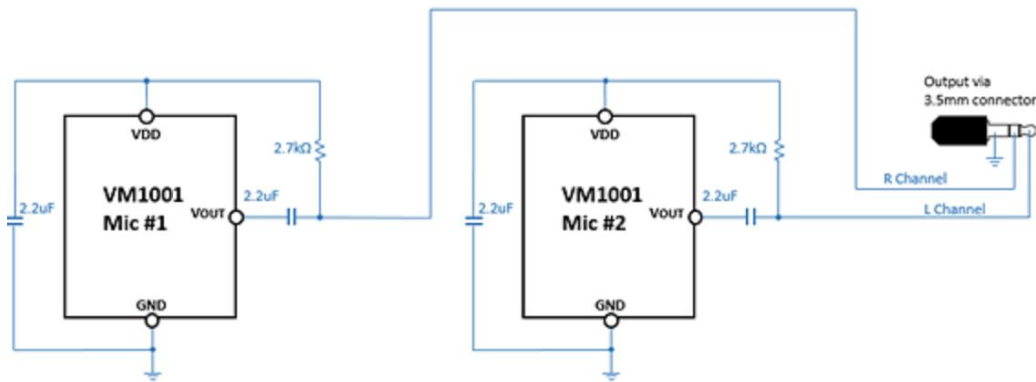

Figure 7. Schematic showing connection between VM1001 mics and 3.5mm connector

## 4.2 Compatible Systems

The following systems have a 2 wire Plug in Power interface compatible with the VM1001 slider board:

- Conexant CX20921 AVS 2 Mic evaluation system
- Zoom H1 Audio Recorder

## 4.3 Absolute Maximum Ratings

The following absolute maximum ratings apply to the VM1001 mics. Please note the Plug in Power bias should be validated to be within the specified Supply Voltage range.

Parameter	Rating	Units
Supply Voltage	-0.3 to +3.6	V
Sound Pressure Level	160	dB re 20 $\mu$ Pa
Operating Temperature Range	-40 to +85	$^{\circ}$ C
Storage Temperature Range	-55 to +150	$^{\circ}$ C

Mechanical Shock	10,000g per IEC 60028-2-27:2008
Vibration	Per MIL-STD 883E, 2007.2

Table 1: Absolute Maximum Ratings

For additional information on Vesper's microphone products, contact [info@vespermems.com](mailto:info@vespermems.com).