

FEATURES

Integrated SiGe PIN photodiode, transimpedance amplifier (TIA), and limiting amplifier (LA)

Power monitor output: 1.0 A/W at O band wavelengths

50 μm diameter germanium photodiode

Input sensitivity

$P_{OMA} = -16.5 \text{ dBm}$

$P_{AVE} = -17.3 \text{ dBm}$ (ER = 6 dB)

PRBS31 at 10.52 Gbps, BER = 10^{-12} , $\lambda = 1270 \text{ nm}$, 1290 nm, 1300 nm, 1310 nm, and 1330 nm

Antireflective coating (ARC) optimized to 1310 nm

Single 3.3 V supply

Power dissipation: 102 mW

Differential output swing: 460 mV p-p

On-chip power monitor function

Die size: 0.835 mm \times 0.675 mm

APPLICATIONS

Optical module receivers up to 11.3 Gbps

Short range 10 Gb SONET, FC, Ethernet, CPRI, OBSAI, and LTE optical receivers

Capable to be in ROSA, BOSA, or MCM packages

GENERAL DESCRIPTION

The [ADN3010-11](#) is a high speed optical receiver featuring a proprietary large area germanium photodiode monolithically integrated with a silicon TIA and LA. The integration of the photodiode eliminates bond wires between the diode and the TIA that provides guaranteed performance and improved manufacturing reliability. The 50 μm diameter photodetector enables an easy optical coupling design when aligned with a single mode fiber (SMF). With a 1310 nm optimized ARC, the [ADN3010-11](#) supports 10GBASE-LR and other applications with extended data rates of up to 11.3 Gbps.

Although the [ADN3010-11](#) can operate in the wavelength range from 850 nm to 1565 nm, it has an antireflective coating (ARC) centered at 1310 nm and is characterized only at original band

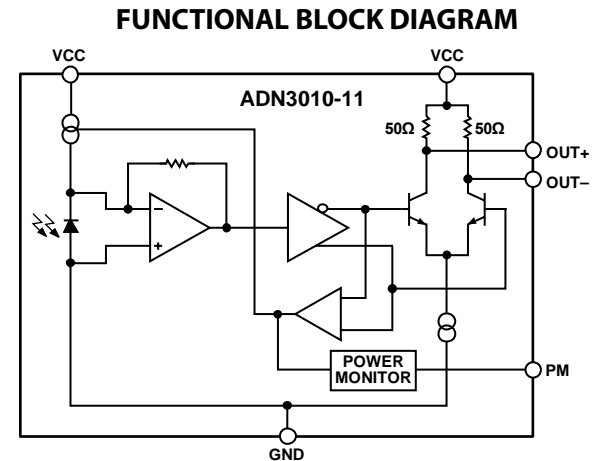

Figure 1.

(O band) wavelengths (1270 nm, 1290 nm, 1300 nm, 1310 nm, and 1330 nm) in this data sheet.

The power monitor pin provides either an output voltage or current that is proportional to the sensed average photocurrent.

Typical power consumption of the [ADN3010-11](#) is 102 mW from a single 3.3 V supply. When the output is saturated, it has a typical differential amplitude of 460 mV p-p at 10.52 Gbps.

The [ADN3010-11](#) is available in die form, and it is operational over the extended industrial temperature range of -40°C to $+85^{\circ}\text{C}$.

TABLE OF CONTENTS

Features	1	Theory of Operation	7
Applications.....	1	Applications Information	8
Functional Block Diagram	1	Bonding	8
General Description	1	Power Monitor (PM) Output Applications.....	8
Revision History	2	Power Monitor Output Estimation	8
Specifications.....	3	Outline Dimensions	9
Absolute Maximum Ratings.....	4	Die Specifications and Assembly Recommendations	9
ESD Caution.....	4	Ordering Guide	10
Pin Configuration and Function Descriptions.....	5		
Typical Performance Characteristics	6		

REVISION HISTORY

9/2016—Rev. 0 to Rev. A	
Changes to Ordering Guide	10

1/2015—Revision 0: Initial Version

SPECIFICATIONS

$T_A = -40^{\circ}\text{C}$ to $+85^{\circ}\text{C}$, $V_{CC} = 3.0\text{ V}$ to 3.6 V , $R_L = 100\ \Omega$ differential (ac-coupled), $\lambda = 1310\text{ nm}$, unless otherwise noted.

Table 1.

Parameter	Test Conditions/Comments	Min	Typ	Max	Unit
OPTICAL INPUT CHARACTERISTICS					
Data Rate			10.52	11.3	Gbps
Photodiode Diameter			50		μm
Input Sensitivity	PRBS31 at 10.52 Gbps, bit error rate (BER) = 10^{-12} , $\lambda = 1270\text{ nm}$, 1290 nm , 1300 nm , 1310 nm , and 1330 nm				
Optical Modulation Amplitude (OMA) Power, P_{OMA}	$T_A = 25^{\circ}\text{C}$, $V_{CC} = 3.3\text{ V}$		-16.5		dBm
Optical Average Power, P_{AVE}^1	$T_A = 85^{\circ}\text{C}$, $V_{CC} = 3.0\text{ V}$ Extinction ratio (ER) = 6 dB, $T_A = 25^{\circ}\text{C}$, $V_{CC} = 3.3\text{ V}$	-15.0	-17.3		dBm dBm
OUTPUT CHARACTERISTICS					
Output Impedance	Differential Each output, single-ended		100 50		Ω Ω
Differential Output Voltage Swing (Limited)	Data rate = 10.52 Gbps		460		mV p-p
Rise/Fall Time	Data rate = 1.0 Gbps 20% to 80%		520 30.5		mV p-p ps
Duty Cycle Distortion	PRBS15 at 10.52 Gbps		0.82		ps
Deterministic Jitter (Peak-to-Peak)	PRBS15 at 10.52 Gbps		22.8		ps
Random Jitter (RMS)	PRBS15 at 10.52 Gbps		1.74		ps
Power Monitor Output (PMO) in O Band ²	$\lambda = 1270\text{ nm}$, 1290 nm , 1300 nm , 1310 nm , and 1330 nm		1.0		A/W
Differential Common-Mode Voltage	OUT+ and OUT- each dc-coupled $50\ \Omega$ to V_{CC}		$V_{CC} - 0.113$		V
DC CHARACTERISTICS					
Supply Voltage, V_{CC}		3.0	3.3	3.6	V
Supply Current, I_{CC}			31	49	mA
PMO Slope	Voltage mode, open circuit voltage output (V_{OC}) Current mode, short-circuit current output (I_{SC})		730 0.73		$\mu\text{V}/\mu\text{W}$ $\mu\text{A}/\mu\text{W}$
PMO Offset	No optical input, voltage mode		32		mV
Interception	No optical input, current mode		32		μA
OPERATING TEMPERATURE RANGE		-40		+85	$^{\circ}\text{C}$

¹ From a known OMA sensitivity and optical ER, P_{AVE} sensitivity can be calculated with

$$P_{AVE}(\text{dBm}) = P_{OMA}(\text{dBm}) + 10\log\left(\frac{10^{(ER/10)} + 1}{2 \times (10^{(ER/10)} - 1)}\right)$$

where $P_{OMA} = -16.5\text{ dBm}$ and $ER = 6\text{ dB}$.

² O band wavelength range is 1260 nm to 1360 nm.

ABSOLUTE MAXIMUM RATINGS

Table 2.

Parameter	Rating
Supply Voltage	4.5 V
Optical Input Peak Power	10 dBm
Maximum Voltage to All Input and Output Signal Pins	$V_{CC} + 0.4 V$
Minimum Voltage to All Input and Output Pins	$GND - 0.4 V$
Storage Temperature Range	$-65^{\circ}C$ to $+125^{\circ}C$
Die Attach Temperature (<30 sec)	$410^{\circ}C$
Junction Temperature	$150^{\circ}C$

Stresses at or above those listed under Absolute Maximum Ratings may cause permanent damage to the product. This is a stress rating only; functional operation of the product at these or any other conditions above those indicated in the operational section of this specification is not implied. Operation beyond the maximum operating conditions for extended periods may affect product reliability.

ESD CAUTION



ESD (electrostatic discharge) sensitive device. Charged devices and circuit boards can discharge without detection. Although this product features patented or proprietary protection circuitry, damage may occur on devices subjected to high energy ESD. Therefore, proper ESD precautions should be taken to avoid performance degradation or loss of functionality.

PIN CONFIGURATION AND FUNCTION DESCRIPTIONS

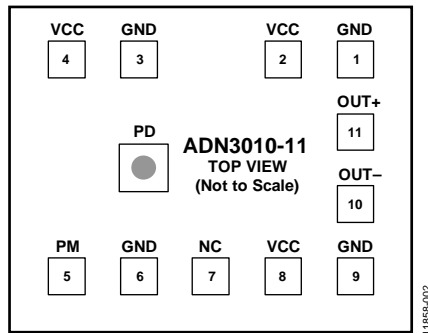

Figure 2. Pad Configuration

Table 3. Pad Function Descriptions

Pad No.	Mnemonic	X (mm) ¹	Y (mm) ¹	Description
1	GND	0.300	0.225	Amplifier Ground.
2	VCC	0.150	0.225	Output Stage 3.3 V Supply.
3	GND	-0.150	0.225	Amplifier Ground.
4	VCC	-0.300	0.225	Input Amplifier 3.3 V Supply.
5	PM	-0.300	-0.225	Power Monitor Output.
6	GND	-0.150	-0.225	Amplifier Ground.
7	NC	0	-0.225	No Connection. Do not bond to this pad.
8	VCC	0.150	-0.225	Output Stage 3.3 V Supply.
9	GND	0.300	-0.225	Amplifier Ground.
10	OUT-	0.300	-0.075	CML, Negative Output. AC coupling is recommended.
11	OUT+	0.300	0.075	CML, Positive Output. AC coupling is recommended.
	PD	-0.140	0	Photodiode.

¹ Referenced to die center.

TYPICAL PERFORMANCE CHARACTERISTICS

T_A = 25°C, V_{CC} = 3.3 V, R_{LOAD} = 100 Ω differential (ac-coupled), λ = 1310 nm, unless otherwise noted.

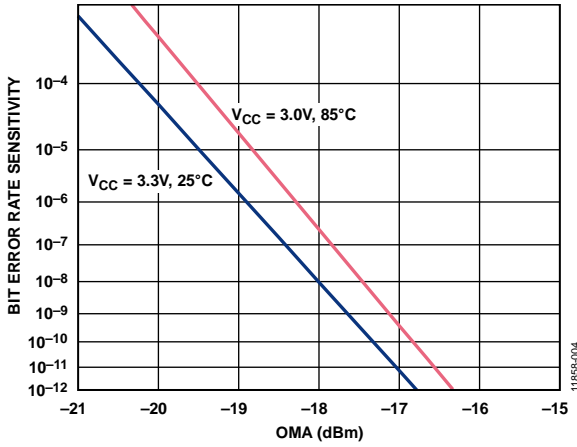

Figure 3. BER Sensitivity at 10.52 Gbps vs. OMA at Various Temperatures and Supplies

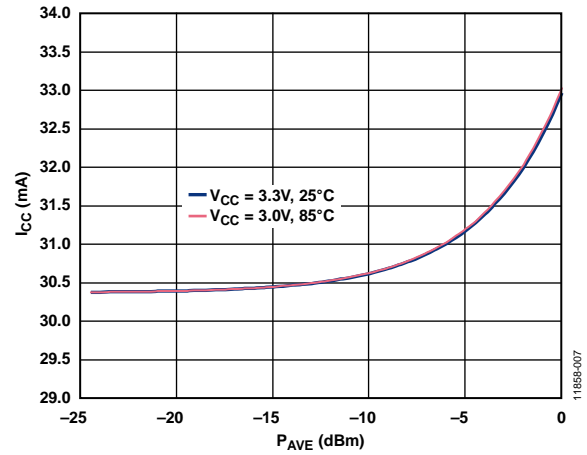

Figure 6. ICC vs. P_{AVE} at Various Temperatures and Supplies

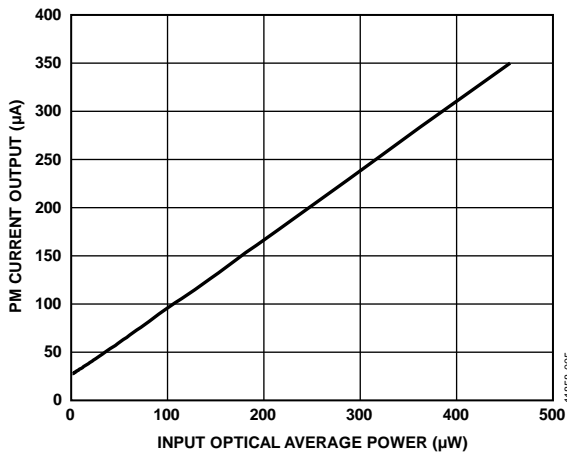

Figure 4. PM Current Output vs. Input Optical Average Power

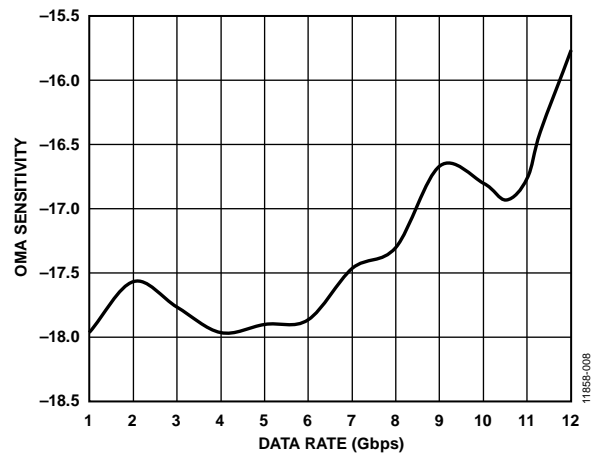

Figure 7. OMA Sensitivity vs. Data Rate

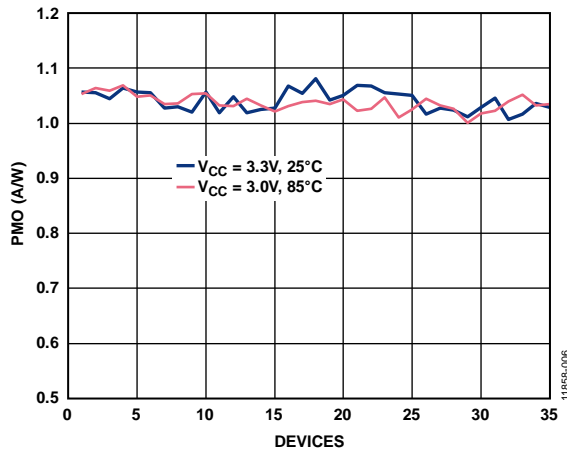

Figure 5. Power Monitor Output at Various Temperatures and Supplies

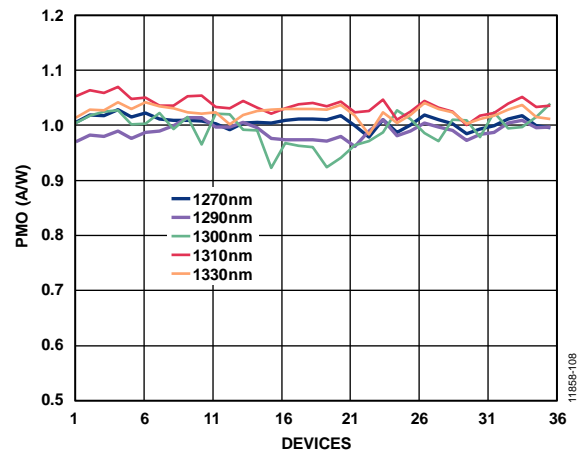

Figure 8. Power Monitor Output at Various Wavelengths, T_A = 85°C, V_{CC} = 3.0 V

THEORY OF OPERATION

The power monitor pin, PM, provides either a voltage or a current output that is proportional to the sensed average photocurrent. This feature allows the user to check how well a fiber or an optical coupling system is aligned to the [ADN3010-11](#) photodetector (PD), which is typically useful during receiver optical subassembly (ROSA) manufacturing.

To receive a PM pin signal from a transistor outline (TO) packaged ROSA, the TO header must support at least five pins.

Figure 3 shows BER at 10.52 Gbps vs. input OMA at various temperatures and supplies. In Figure 3, fitting the curve to a

best fit straight line allows extrapolation of the OMA sensitivities at either BER = 10^{-10} or 10^{-12} from the measured OMA input data at a wider range of BER. The extrapolated BER = 10^{-10} sensitivity spans from -16.8 dBm to -17.4 dBm OMA and the BER = 10^{-12} sensitivity spans from -16.4 dBm to -16.8 dBm OMA at various temperature and supply voltages.

Figure 6 shows the [ADN3010-11](#) supply current, I_{CC} , vs. optical average power, P_{AVE} , at various temperatures and supply voltages.

APPLICATIONS INFORMATION
BONDING

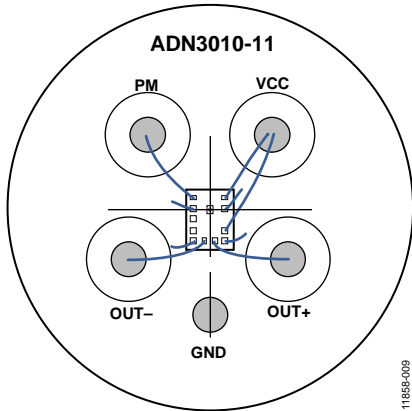

Figure 9. Typical Bonding Diagram for 5-Pin Metal Header Package [TO-46]

By using the recommended sequence in Table 4, the ESD or electronics stress introduced by a bonding tip can be reduced.

Table 4. Recommended Bonding Sequence

Bonding Order	Pad No.	Mnemonic
1	9	GND
2	8 ¹	VCC
3	6	GND
4	5	PM
5	4	VCC
6	3	GND
7	2	VCC
8	1	GND
9	11	OUT+
10	10	OUT-

¹ Bonding this pad is not necessary in a metal header package [TO].

POWER MONITOR (PM) OUTPUT APPLICATIONS

The PM output can be set in either voltage output mode or current output mode for a mirrored photodiode current, I_{PD} , which includes sensed photocurrent plus a preset offset current. Therefore, I_{PD} is proportional to the sensed photodiode current.

The setup of the V_{OC} (open circuit voltage output) and I_{SC} (short circuit current output) measurement is shown in Figure 10.

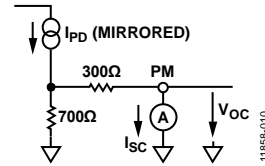

Figure 10. Typical PM Circuit and Test Setup

V_{OC} and I_{SC} are determined depending on the detection accuracy of I_{PD} , as follows:

$$V_{OC} = 0.7 \text{ V at } I_{PD} = 1.0 \text{ mA} \pm 10\%$$

$$I_{SC} = 700 \mu\text{A at } I_{PD} = 1.0 \text{ mA} \pm 5\%$$

where I_{PD} is proportional to the PD dark current and process tolerance.

The PMO offset is composed of the ADN3010-11 photodiode dark current (mirrored) and a preset offset current (see Table 1 for details).

POWER MONITOR OUTPUT ESTIMATION

The PMO can be used to achieve optimal optical coupling. To use the PM pin properly, calibrate the integrated PD dark current out because the dark current is temperature and reversed bias dependent.

In voltage mode,

$$PMO = (V_{OC} - V_{DK})/0.7/P_{AVE} \text{ (optical power)}$$

In current mode,

$$PMO = (I_{SC} - I_{DK})/0.7/P_{AVE} \text{ (optical power)}$$

where:

PMO is the power monitor output (A/W) in voltage and current modes.

V_{OC} is the voltage output (mV) produced by an input light with an optical average power, P_{AVE} .

V_{DK} is the voltage output (mV) at no light input, $P_{AVE} = 0 \text{ mW}$.

P_{AVE} is the average optical power of an input light to the receiver PD.

I_{SC} is the current output at an input light with $P_{AVE} = 100 \text{ mW}$.

I_{DK} is the current output (μA) at no light input, $P_{AVE} = 0 \text{ mW}$.

OUTLINE DIMENSIONS

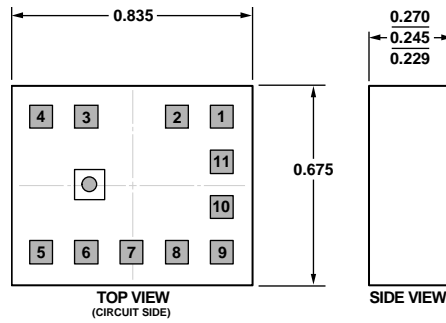

Figure 11. 11-Pad Bare Die [CHIP]
(C-11-1)
Dimensions shown in millimeters

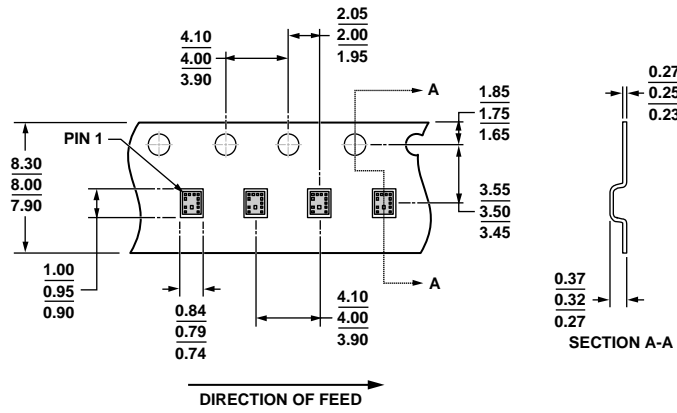

Figure 12. Tape and Reel Outline Dimensions
Dimensions shown in millimeters

DIE SPECIFICATIONS AND ASSEMBLY RECOMMENDATIONS

Table 5. Die Specifications

Parameter	Value	Unit
Die Size	0.835 (-0.04) × 0.675 (-0.04)	mm
Saw Blade Size	0.04	mm
Die Grind Thickness	0.25 ± 0.0127 (10.0 ± 0.5 mils), 675 μm before backside grinding	mm
Bond Pad	0.076 × 0.076	mm
Backside Contact	Ground	Not applicable
Passivation Openings	0.076 × 0.076	mm
Photodiode Diameter	0.05	mm

Table 6. Assembly Recommendations

Assembly Component	Recommendation
Die Attach	Ground
Bonding Method	Ball or wedge
Bonding Sequence	See Table 4

ORDERING GUIDE

Model ^{1, 2}	Temperature Range	Package Description	Ordering Quantity	Package Option
ADN3010-11-50A-DF	-40°C to +85°C	6-Inch Film Frame	12,792 per film frame	C-11-1
ADN3010-11-50A-RL7	-40°C to +85°C	11-Pad Bare Die [CHIP] Reel	5,000 per reel	C-11-1
ADN3010-11-50A-WP	-40°C to +85°C	2" × 2" Waffle Pack	Variable per waffle pack ³	C-11-1

¹ The ordering guide model is composed of the following fields: -11: data rate option, -50: the integrated photodiode diameter, A: the release version, -Rxx: the reel package option, -DF: film frame package option, and -WP: waffle package options.

² Contact Analog Devices, Inc., for more information about the 6-inch film frame or 2 in × 2 in waffle packs.

³ Order quantity N dependent, $N = 10 \times i$ ($i = 1, 2, \dots, 40$).