

Features
• Low DCR, High Rated Current
• Magnetic Shielded Structure
• Lead Free Product, RoHS Compliant
• Carrier Tape Packing
• Operating Temperature -40°C ~ 125°C

Applications
• Use in Buck Converter
• Laptops
• Displayer
• Network Communication Equipment

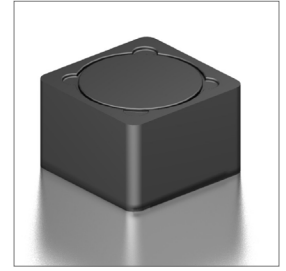

Part Numbering Guide

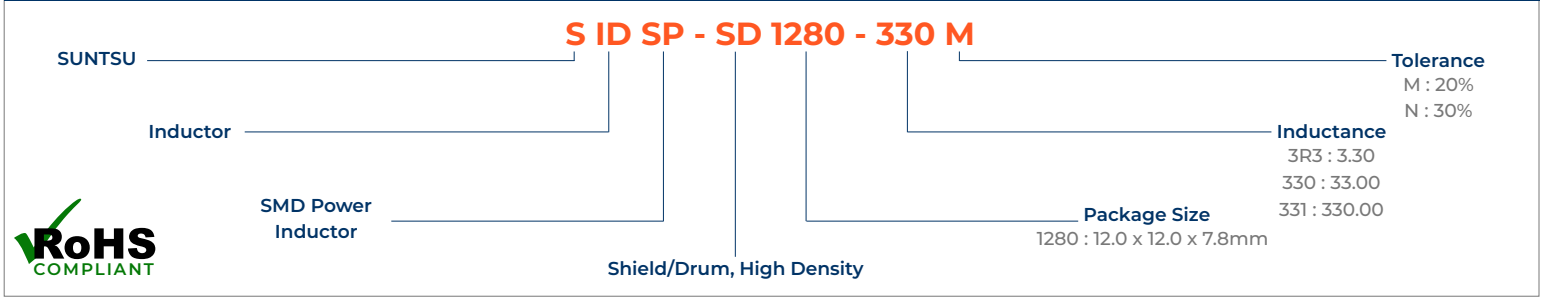

Part Number	Inductance (μH)	Tolerance	D.C.R. (mΩ) Typical	D.C.R. (mΩ) Max	Saturation Current (A) Typical	Temp. Rise Current (A) Typical
SIDSP-SD1280-1R4N	1.40	±30%	6.37	7.64	26.20	11.00
SIDSP-SD1280-2R2N	2.20	±30%	9.54	11.50	21.30	9.10
SIDSP-SD1280-3R3N	3.30	±30%	11.20	13.40	18.30	8.40
SIDSP-SD1280-4R7N	4.70	±30%	13.00	15.60	15.20	7.80
SIDSP-SD1280-5R6N	5.60	±30%	14.70	17.60	13.70	7.30
SIDSP-SD1280-6R8N	6.80	±30%	16.20	19.40	12.70	7.00
SIDSP-SD1280-8R2N	8.20	±30%	18.00	21.60	11.50	6.60
SIDSP-SD1280-100M	10.0	±20%	19.80	23.70	10.42	6.30
SIDSP-SD1280-120M	12.0	±20%	21.70	26.10	9.61	6.00
SIDSP-SD1280-150M	15.0	±20%	28.70	34.40	8.40	5.10
SIDSP-SD1280-180M	18.0	±20%	31.20	37.40	7.60	5.00
SIDSP-SD1280-220M	22.0	±20%	39.00	46.80	6.90	4.50
SIDSP-SD1280-270M	27.0	±20%	44.10	52.90	6.22	4.20
SIDSP-SD1280-330M	33.0	±20%	56.30	67.50	5.68	3.70
SIDSP-SD1280-390M	39.0	±20%	62.70	75.20	5.14	3.50
SIDSP-SD1280-470M	47.0	±20%	71.50	85.80	4.60	3.30
SIDSP-SD1280-560M	56.0	±20%	83.40	100.00	4.46	3.00
SIDSP-SD1280-680M	68.0	±20%	103.00	123.00	3.90	2.70
SIDSP-SD1280-820M	82.0	±20%	119.00	143.00	3.51	2.50
SIDSP-SD1280-101M	100.0	±20%	137.00	164.00	3.36	2.40
SIDSP-SD1280-121M	120.0	±20%	182.00	218.00	2.91	2.10
SIDSP-SD1280-151M	150.0	±20%	206.00	247.00	2.60	1.90
SIDSP-SD1280-181M	180.0	±20%	250.00	300.00	2.57	1.75
SIDSP-SD1280-221M	220.0	±20%	300.00	360.00	2.22	1.63
SIDSP-SD1280-271M	270.0	±20%	380.00	456.00	1.94	1.40
SIDSP-SD1280-331M	330.0	±20%	467.00	560.00	1.79	1.20
SIDSP-SD1280-391M	390.0	±20%	525.00	630.00	1.63	1.10
SIDSP-SD1280-471M	470.0	±20%	683.00	819.00	1.48	1.00
SIDSP-SD1280-561M	560.0	±20%	767.00	920.00	1.36	0.98
SIDSP-SD1280-681M	680.0	±20%	986.00	1183.00	1.25	0.90
SIDSP-SD1280-821M	820.0	±20%	1172.00	1406.00	1.16	0.80
SIDSP-SD1280-102M	1000.0	±20%	1322.00	1586.00	1.01	0.70

Saturation Current vs Temperature Rise Current Curve

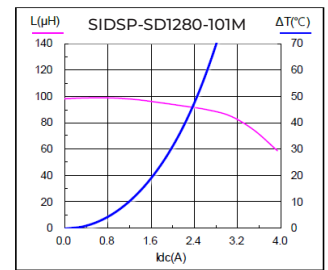
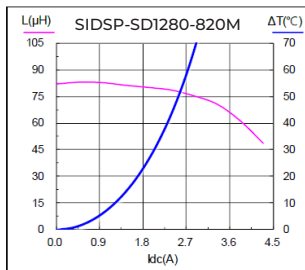
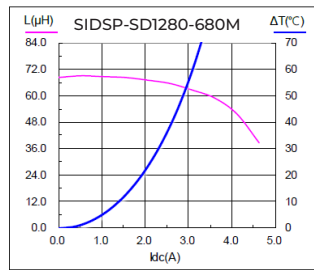
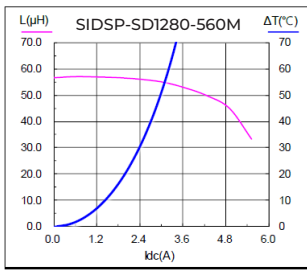
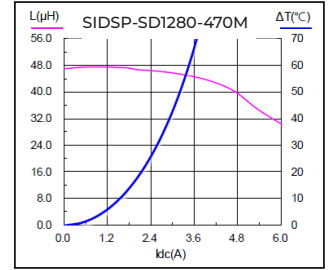
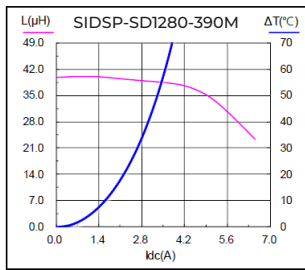
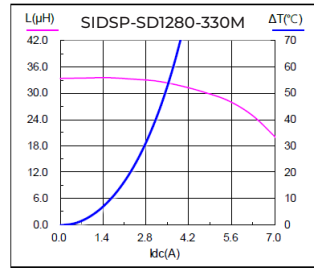
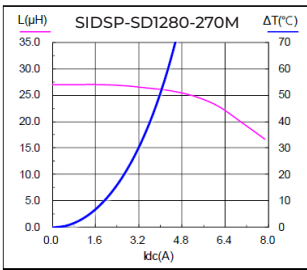
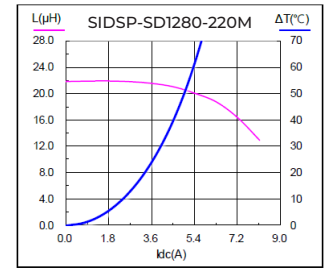
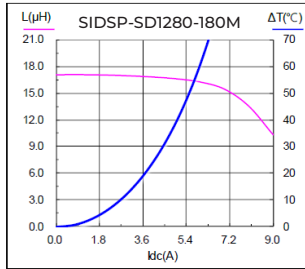
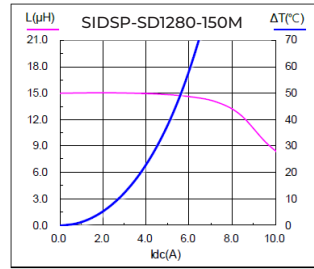
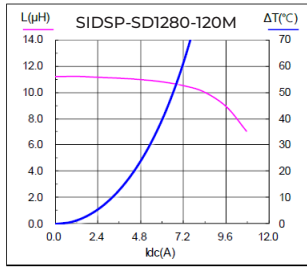
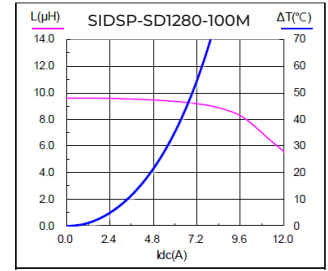
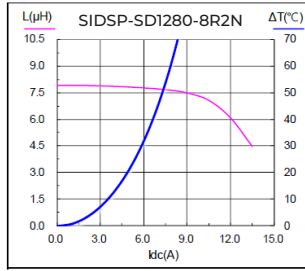
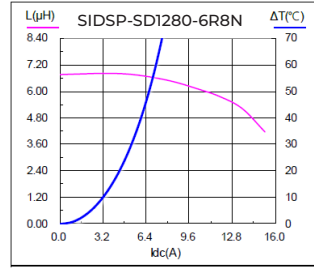
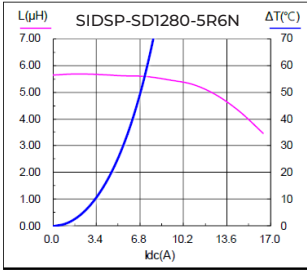
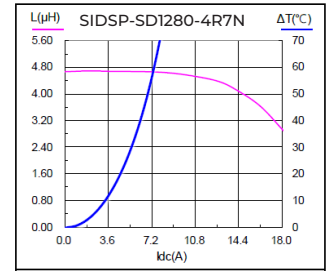
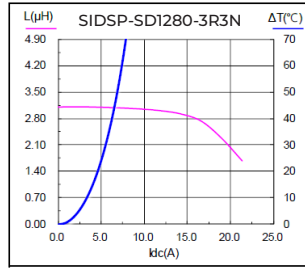
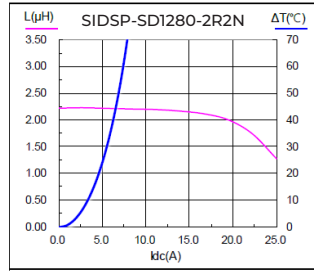
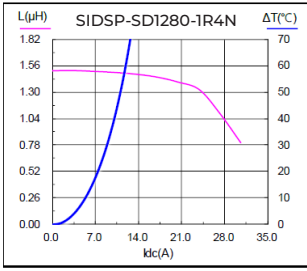

Saturation Current vs Temperature Rise Current Curve

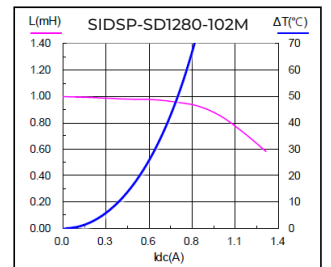
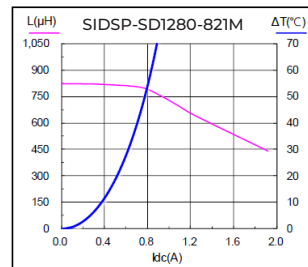
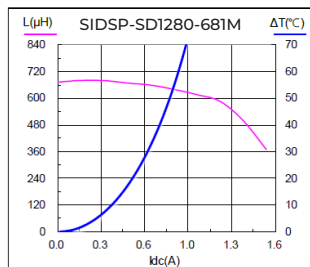
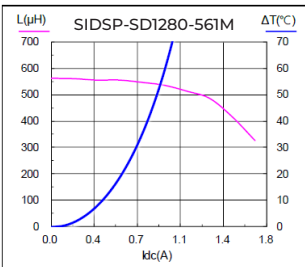
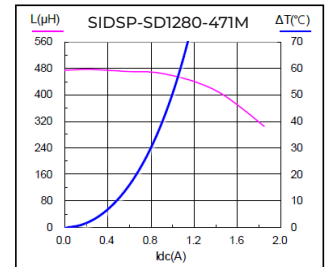
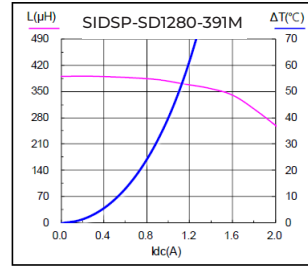
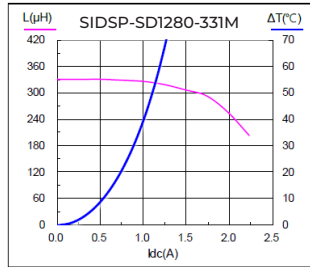
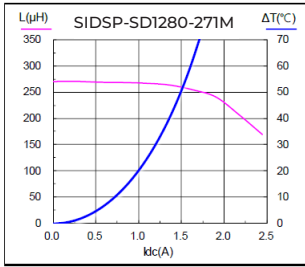
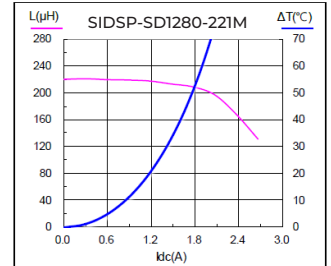
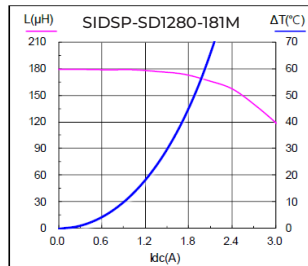
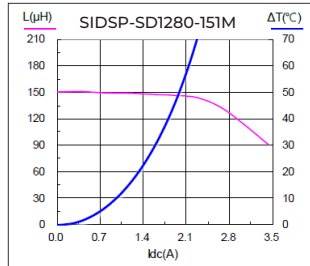
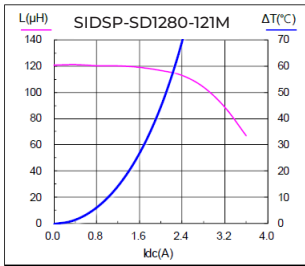

- All Data is tested based on 25°C ambient temperature.
- Inductance measure condition at 100kHz, 0.1V.
- Saturation current: The actual value of DC current when the inductance decrease 20% of its initial value.
- Temperature rise current: The actual value of DC current when the temperature rise is $\Delta T 40^{\circ}\text{C}$ ($T_a=25^{\circ}\text{C}$).

Outline Drawing & Land Pattern

All dimensions are in millimeters (mm) unless otherwise noted. Drawings are not to scale.

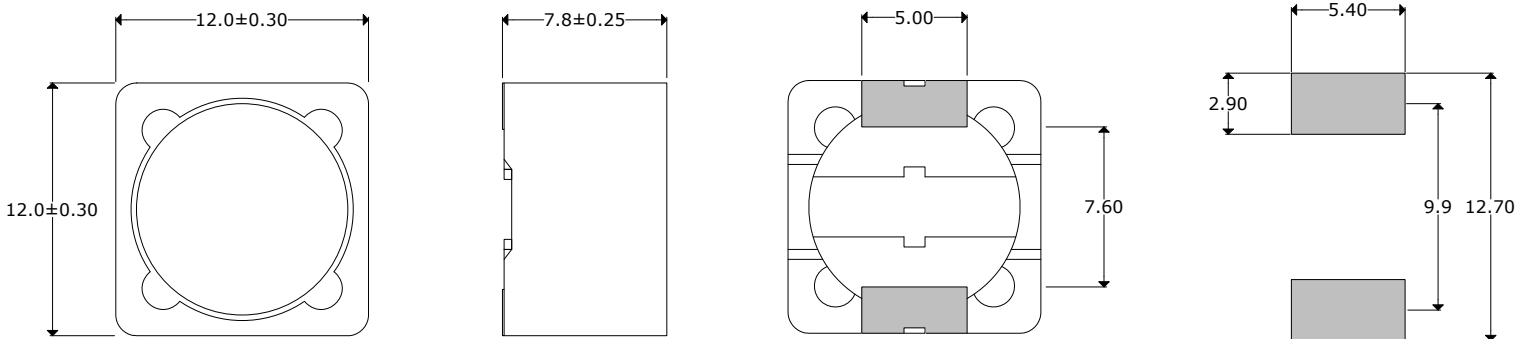

Reflow Profile & Part Marking

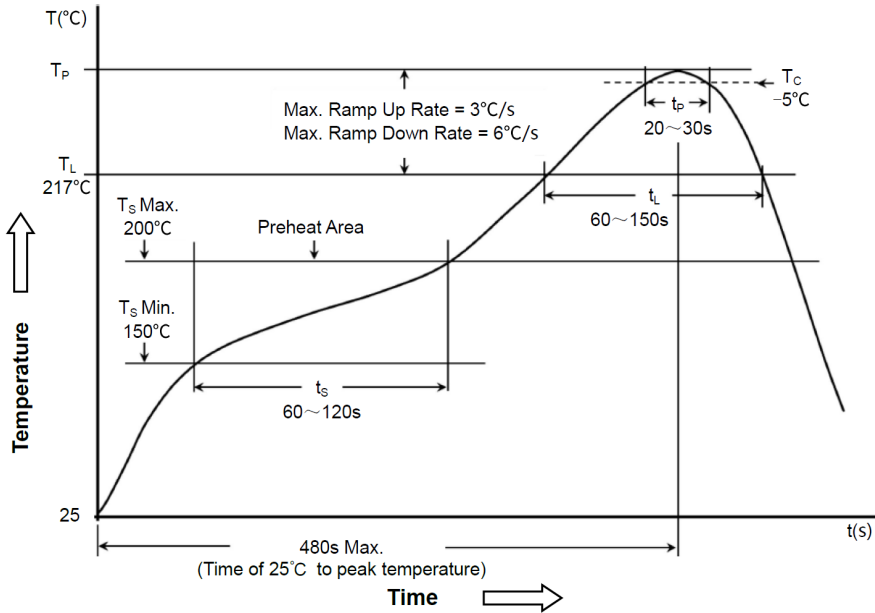

Line 1 : X X X
 Inductance (μH)

Classification of Peak Package Body Temperature (T_p)

	Package Thickness	Package Volume		
		<350 mm ³	350~2000 mm ³	>2000 mm ³
PB-Free Assembly	<1.6mm	260°C	260°C	260°C
	1.6~2.5mm	260°C	250°C	245°C
	≥2.5mm	250°C	245°C	245°C

Example:
 3.30 μH : 3R3
 33.00 μH : 33R
 330.00 μH : 331
 3300.00 μH : 332

Tape And Reel Dimensions

All dimensions are in millimeters (mm) unless otherwise noted. Drawings are not to scale.

500pcs / Reel

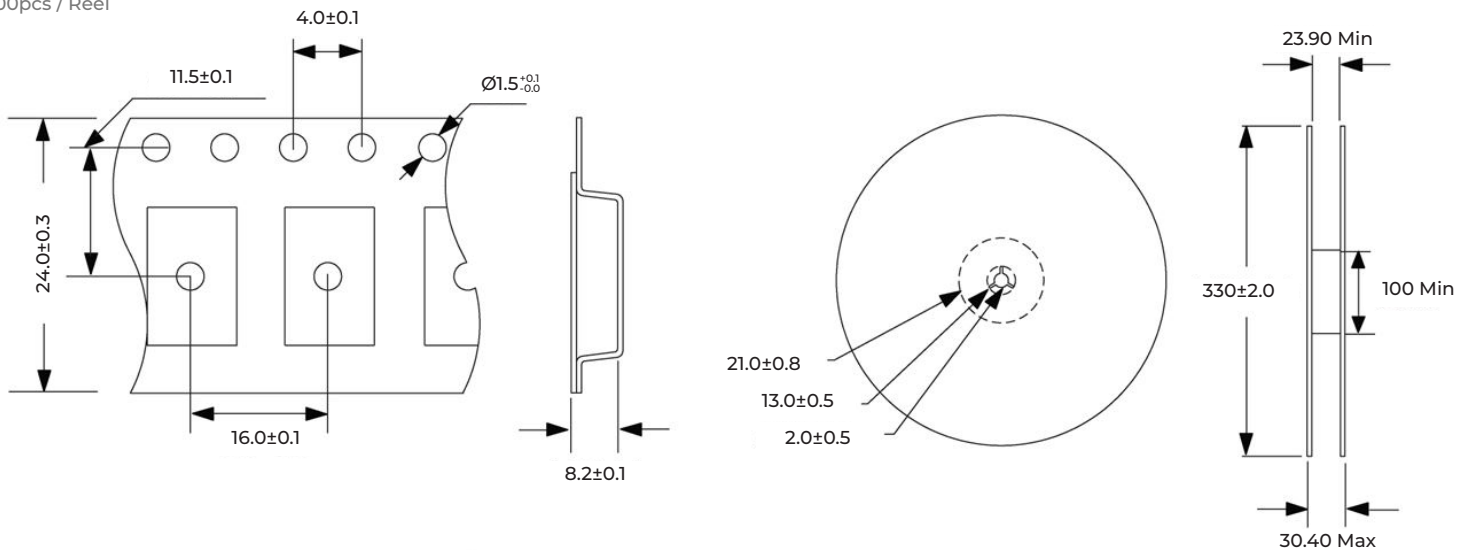

Environmental Specifications		Mechanical Specifications	
Temperature Cycling	MIL-STD-883, Method 1010, Condition B	Mechanical Shock	MIL-STD-202, Method 213, Condition C
Fine Leak Test	MIL-STD-883, Method 1014, Condition A	Vibration	MIL-STD-883, Method 2007, Condition A
Gross Leak Test	MIL-STD-883, Method 1014, Condition C	Resistance to Soldering Heat	MIL-STD-202, Method 210, Condition K
Moisture Resistance	MIL-STD-883, Method 1004	Resistance to Solvents	MIL-STD-202, Method 215
Moisture Sensitivity	J-STD-020, MSL 1	Solderability	MIL-STD-883, Method 2003

Notice of Use	
1. Product in packing storage condition : temperature 5~40°C, RH ≤ 70%.	6. When this product will be used on a similar or new project to the original one, sometimes it might be unable to satisfy the specifications due to different condition of usage.
2. A storage of inductors longer than 12 months is not recommended. Within other effects, the terminals may suffer degradation, resulting in bad solderability. Therefore, all products shall be used within the period of 12 months based on the day of shipment.	7. This inductor itself does not have any protective function in abnormal condition, such as overload, short-circuit, open-circuit conditions, etc. Therefore, it shall be confirmed that there is no risk of smoke, fire, dielectric withstand voltage, insulation resistance, etc. or use in abnormal conditions protective devices or protection circuit in the end product.
3. Do not keep products in unsuitable storage conditions, such as areas susceptible to high temperatures, high humidity, dust or corrosion.	8. Hi-Pot test with higher voltage than spec will damage material and shorten its life.
4. Always handle product with care.	9. If using in potting compound, the magnet wire coating might be damaged.
5. Don't touch electrodes directly with bare hands as oil secretions may inhibit soldering. Always ensure optimum conditions for soldering.	10. Refrain from rinsing coils.